



## Installation instructions Floorify Planks

Version: 01/05/2024

EN

To obtain an optimal result, we recommend reading the following installation instructions carefully and follow them closely.

### HAPPY TO HELP YOU

We are always at your disposal for all your questions. Our help center can be reached at [hello@floorify.com](mailto:hello@floorify.com) or by phone on +32(0)51 140 180 from Monday to Friday from 8.30 am to 6 pm.



Be sure to check out our **installation videos** and **FAQs** on [www.floorify.com](http://www.floorify.com)

### WHERE CAN YOU INSTALL FLOORIFY?

Floorify Planks are an aesthetic floor finishing designed for **residential** and **commercial** indoor use.

Floorify Planks are waterproof and can be used as **floating floor covering** in **damp rooms** such as bathrooms, toilets or kitchens. Floorify Planks are not suitable as floor covering for walk-in showers (or other rooms with integrated water drainage), saunas, swimming pools or other wet areas.

#### **AMBIENT TEMPERATURE**

Floorify Planks are designed for **indoor** installation in **heated rooms** (2-40 °C). The optimal ambient temperature of the floor is between 18-25°C.

The product is not intended for outdoor use or in unheated/uninsulated applications such as campers, ships, verandas, conservatories or solariums.

**Protect the floor against extreme direct heating** (floor surface locally >60°C) If this is not possible, local gluing of the floor can be considered. Ask your distributor for advice or contact us. I.e. an open fire or stove, you can use a fire plate or fire-resistant mat for example.

#### **UNDERLAY**

Floorify Planks should always be placed on top of a **suitable high-quality underlay** such as the Floorify Comfort or the Performance underlay. These Floorify underlays were specially developed for use in combination with the Floorify Planks collection. That is why the Floorify underlays guarantee optimum performance of your Floorify Planks:

- To level out (within the flatness tolerances of the subfloor – see “important technical information)
- Prevents grinding caused by grit or pebbles
- Increases impact resistance and walking comfort

- Can be combined with both floor heating and floor cooling
- Isolates the transit sound ( $\Delta L_w$  21 dB or  $\Delta L_{in}$  10 dB)

In case of damage or accelerated wear of the floor caused by the use of an underlay other than the Floorify underlays, the warranty given by Floorify will lapse.

### **MOISTURE BARRIER**

In older buildings without a proper water barrier, or where there is a high risk of rising damp, due to a wet basement for example, the use of a moisture barrier (0.2mm) is highly recommended. Also with underfloor heating in wet construction (screed, leveling compound), we recommend to place a moisture barrier between the subfloor and the underlay.

**Note: The screed must always be completely dry and meet the specified moisture values, even with a moisture barrier! A moisture barrier does not stop major moisture problems.**

In high-moisture areas, such as bathrooms, we recommend applying a **water-tight foil (0,2mm)** beneath the Floorify underlays. Although Floorify Planks are completely water-resistant, water can always seep in between the joints or beneath the edge of the floor, permeating the underground and causing damage. A moisture barrier creates an additional barrier, protecting the screed from moisture above.

### **FLOATING INSTALLATION**

Floorify Planks are always installed as a **floating floor system, without glue**. The floor boards are provided with a 360° click system that allows you to continue laying in any direction.

The floor components must at all times be able to **expand and contract freely** in response to changes in temperature. Therefore, you may never glue, nail or fix the floor boards to the screed, walls or any other part of the room.

### **EXPANSION JOINTS**

At least **5 mm free expansion joint** around all walls, door frames, windows, sills, pipes and heavy objects in rooms. **Never use a silicone sealant** or other flexible paste to fill the expansion joints.

During installation, **spacers** must be used around all walls, thresholds, door frames, windows, pipes and heavy objects so that the expansion gap of at least 5 mm is always respected and the Floorify floor does not shift. Only remove the blocks after the Floorify floor has been completely installed.

Expansion joints can be covered visually at the end with matching skirtings and/or profiles.

### **EXPANSION REQUIREMENTS**

Floorify can be laid out to a maximum surface area of **20x20m** (400m<sup>2</sup>). In case of longer or wider surfaces than 20m, additional expansion joints must be provided.

If there is a **temperature difference of 12°C or more** between different rooms, an expansion joint must be provided. This also applies to surfaces **where there is underfloor heating in one room and not in the other**. These two floor parts can expand differently, with tension as a result.

### **HEAVY ELEMENTS ON THE FLOOR**

We recommend to place heavy objects such as kitchen islands, built-in cupboards, etc. before installing Floorify Planks and not install them on top of the floor.

**Heavy objects can block the floor** and prevent it from expanding/shrinking during temperature changes.

As an indication, heavy objects may not be heavier than 1000 kg and/or may not exert a load greater than 50 kg/cm<sup>2</sup>. Always respect the 5 mm expansion gap around cabinet legs , plinths, ...

Advice: Check out how to finish the floor around a kitchen island on our website.



## TRANSPORT AND STORAGE

It is important to always store and/or transport the boxes with Floorify floor panels on a **dry and solid surface, in neat stacks, laying flat** (so not overhanging) and never vertically.

Store your Floorify floor indoors and within a temperature range of 2-40°C.

## PREPARATION

### **ACCLIMATIZATION AND TEMPERATURE**

To guarantee an effective installation experience, it is essential to store the floor horizontally for at least **12h** in the room where the Floorify floor is to be installed. This to achieve the **ideal installation temperature of 18°C-25°C**. This allows the material to “de-stress” any tension it has sustained during transport or storage. Maintain this temperature for at least 24h before and after the installation.

During the life cycle of the floor, the **ambient temperature must be at least 2°C and maximum 40°C**. Protect the floor against extreme direct heat (floor surface locally >60°C).

We recommend a relative humidity of 40-80%.

### **WHAT DO YOU NEED?**

You do not need much material to install a Floorify floor. A sharp Stanley knife, a measuring rod, a pencil and spacers (5mm) are essential.

Other material that is useful in certain situations or allows you to work more precisely: a handsaw, jigsaw power tool and/or electric saw with trespas or metal blade, a crowbar, a rubber hammer, carpenter’s square, an angle meter, a vacuum cleaner, personal protective equipment, ...

### **SCREED (SUBFLOOR)**

Floorify Planks can be installed on various subfloors such as concrete, sand cement, anhydrite, wood, ceramic tiles, etc. The screed must be **hard, sufficiently flat, non-resilient** and must meet all the prescribed conditions.

A decent preparation of the screed is essential for an optimal result. First remove all existing soft and/or floating floor coverings such as carpet, felt, vinyl and laminate. Hard, non-floating floor coverings such as tiles or glued parquet can remain in place.

**The screed must be clean, leveled, permanently dry and stable.** Remove all traces of plaster, paint, glue, oil, grease, etc. Vacuum the floor thoroughly.

Floorify is **an aesthetic floor finish** and does not serve to solve structural problems.

### **UNEVENNESS**

Roughness, cavities or bumps in the screed can cause an uneven floor surface and thus accelerate the

wear of the Floorify floor or click system. They can also lead to seam formation. Therefore, the subfloor must not have floor height difference of more than 5 mm over 2 linear meters or 1 mm over 20cm. Thanks to the strong Rigid Core in combination with the Floorify underlays, you can bridge these slight bumps.

Are the unevennesses larger? Then you can level out the screed with a **suitable levelling compound or solid board material**. Bumps must be sanded away.

Another type of underlay with a higher levelling capacity can also be used.

Ask your dealer or installer for advice. Please note, damages related to the use of another type of underlay is not covered by the Floorify warranty.

### **PREPARATION FOR A CONCRETE OR SCREED FLOOR**

Always give a freshly poured screed, concrete or anhydrite screed sufficient time to dry out. The moisture content of the screed must not exceed the following values before installation and during its life cycle:

	Cement bonded	Anhydrite
No underfloor heating	<2% CM	<0,5% CM
With underfloor heating	<1,5% CM	<0,3% CM

Always keep the above values in mind!

Always measure, record and store the results of the moisture measurements. Be aware that in deeper layers there may still be a lot of **residual moisture**. **If underfloor heating applies, allow the screed to dry naturally enough before starting the heating-up protocol**. Once the floor is dry enough, we recommend installing a moisture barrier between screed and underlay.

Repair surface imperfections with an appropriate repair compound and check if a primer or sealer is needed. Visually smooth does not necessarily mean that the floor is levelled. Always check the slope of the screed and correct where necessary.

### **PREPARATION IN CASE OF CERAMIC TILES**

It is not necessary to fill or level the joints between the tiles as long as they are **<5 mm wide and/or <4 mm deep**. Wider or deeper joints may sound hollow or provide insufficient support for the floor. Also check that no tile edges protrude upwards and that there is no moisture problem in the joints. The tiles must be completely fixed.

### **PREPARATION IN CASE OF WOODEN SUBFLOOR**

Check the floor for signs of **mould and/or insect infestation**. Make sure that the screed is levelled and **nail down any loose parts**. If necessary, apply a levelling floor or levelling compound to optimally prepare the covering floor. It is essential that the crawl space between the floor and the wooden screed is always **ventilated**. Remove any obstacles and ensure sufficient ventilation (minimum 4 cm<sup>2</sup> total ventilation opening per m<sup>2</sup> of floor). Always check the **moisture content** of the wooden floor. This may not be more than 10%.

### **MOISTURE IN THE SUBFLOOR**

Although the Floorify Planks are insensitive to moisture, they are not intended for use as a moisture-inhibiting or waterproof system. **In case of moisture, the screed must be sufficiently dried out or made vapour-tight before the Floorify floor is installed**. Moisture or rising residual moisture under the floor can lead to **unhealthy mould formation and/or push up the floorboards** with the chance of permanent deformation.

In older buildings without a proper water barrier, or when there is a high risk of rising damp, due to a wet basement for instance, the use of a vapour barrier (0.2 mm) is highly recommended. Also for underfloor heating in a wet construction.

### **UNDERFLOOR HEATING AND COOLING**

Floorify Planks can be installed on a subfloor with traditional underfloor heating and/or cooling (water-based and/or electrically thermostatically controlled) incorporated **in the subfloor or levelling compound. The mass between the heating element and the underlay must be at least 9mm.**

The room temperature of the Floorify floor **cannot exceed 29°C**. Before, during and at least 24 hours after the installation of your Floorify floor, the room temperature must remain between 18°C-25°C. The floor heating system can then be gradually increased or decreased, with a maximum of **5°C per day**.

Always check the deep lying residual moisture with underfloor heating in a newly poured screed. Allow the screed to **dry out sufficiently** and then always go through the entire **heating-up protocol!** The floor heating must be extensively tested and there must be a **moisture measurement** before the Floorify floor is installed. Moisture measurement results must be recorded. In case of underfloor heating in a wet construction (screed, levelling), we always recommend installing a moisture barrier between the screed and the underlay.

The heating behaviour and setting of the underfloor heating is the responsibility of the end user.

There are many different types of underfloor heating with different structures. For example, the use of a moisture barrier between layers is sometimes mandatory. Always check the suitability of the underfloor heating or cooling system in the manufacturer's instructions.

**More up-to-date information on types of underfloor heating can be found on our website.**



The recommended minimum water temperature for an **underfloor cooling system is 18°C**.

If the water temperature is lower than 18°C or the difference between the water temperature and the room temperature is too big, this can lead to condensation. A built-in condensation monitoring system can prevent this. When using an underfloor cooling system, make sure that there is always a good **control unit** with a safety device against temperatures that are too high and/or too low.

Always seek advice from the installer of your heating and/or cooling system.

## **IMPORTANT POINTS OF INTEREST BEFORE INSTALLATION**

### **PRODUCTION NUMBER**

The production number of your Floorify floor can be found on the short side of the packaging and on the back of each floor board. For example: 20210523F100. Small colour variations in the same batch number contribute to the natural look of your Floorify floor.

Two different batches can differ slightly in colour and/or gloss level. **We therefore recommend always working from the same batch.** Check this before installing the floor.

### **VISUAL CHECK**

Checks must be made in optimal light conditions, before and during installation. Floor boards **with visible defects can never be installed**. An installed board with a visible defect is considered as being accepted.

### **MIX**

Mix floor panels from different packs during the installation. This ensures a **good spread of the different floor panels and avoids possible color contrasts**. For the most beautiful, natural result, avoid two identical floor panels close together.

### **30CM OVERLAP**

Always ensure that there is a **minimum distance of 30cm between two end joints**. Vary the distances for a natural effect. Cut off pieces for the last floor section in a row can be used again as the first floor section in the following rows. Advice: Skip at least 1 row to avoid a staircase effect.

### **LAYING DIRECTION**

Floorify can be laid in any direction thanks to the **360 degree click system**.

Visually, you get the best result if you lay the floor panels parallel to the longest wall and/or in the direction of light. This way the structures are more visible.

### **STRAIGHT START**

Pay close attention to the placement of the first 2-3 rows. **Make sure that these are in one straight line and that all joints close nicely**. Otherwise laying errors will continue in the rest of the floor. A good start is half the battle.

### **MEASURING THE SPACE**

It is important to measure the (most important) spaces before installation. This measurement helps you determine whether the first row needs to be sawn to achieve an even distribution left and right. The first and last row should be at least 1/3 of the width of a floor section. The hallway is often an important reference point in the house.

**Make an installation plan before you start.**



### **CUTTING WASTE**

Always calculate more floor superficies than the area that is to be installed. We recommend the following percentages: **planks and small tiles 5%, tiles 10% and herringbone 15%**.

Please note: these are guideline figures. The exact percentage may vary depending on the space. Ask your distributor for advice.

Did you know you can return your cutting waste to the distribution point?

Recycling your cut-offs is very easy with Floorevive, Floorify's recycling program. Do you have cut-offs left over after installing your vinyl floor? Don't throw them away! Just bring them back to your Floorevive storefront. We will recycle it for you. As a thank you for your commitment to the planet, you'll get a free bottle of Conny maintenance product in return and we'll plant a tree for you in Madagascar!

Scan the QR code and find a Floorify distributor near you.



### **BUILDING HEIGHT**

The total thickness of a Floorify floor + Floorify Comfort underlay is **6 mm – 6.5 mm**, depending on the chosen format. With the Floorify Performance underlay, you will have a thickness of **5.5 mm - 6 mm**, depending on the chosen format. Keep this in mind for the height of the doors, kitchen island, etc.

## **INSTALLATION SMALL PLANKS**

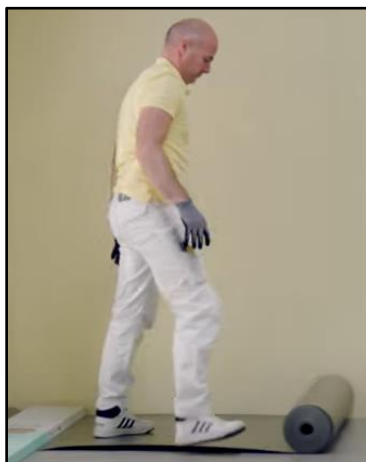
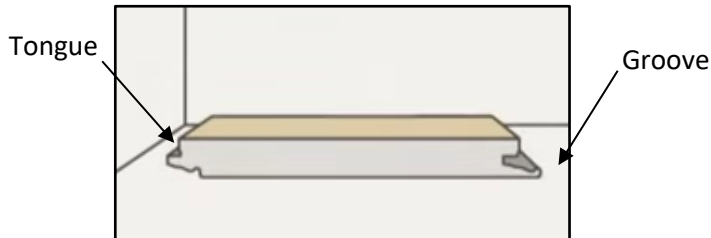

### **Underlay**

Start in the corner of the room and roll out the Floorify underlay. Place the Floorify underlay strip by strip, according to the width and as you progress with the installation of the floor. Always lay the strips next to each other and make sure they do not overlap. Never lay a double layer of Floorify underlay. Taping the underlay to each other or to the subfloor is not necessary.

Always use the same underlay and don't combine different underlays.

### **PART 1: INSTALLATION OF THE FIRST TWO ROWS**

We pay a lot of attention to the installation of the first rows because it is extremely important that they are perfectly aligned.

**ADVICE:** You can assemble the first two rows away from the wall and then slide them towards the wall later. This way you have more room to move.

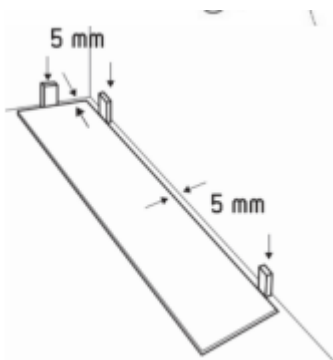

1. Start with a first, full length plank (n°1), which comes in the top left corner of your room. Preferably lay the 2 sides with tongue towards the walls and make sure that the expansion joint of 5 mm is

respected. The groove or tongue is not part of the expansion joint. Cut them off if necessary.

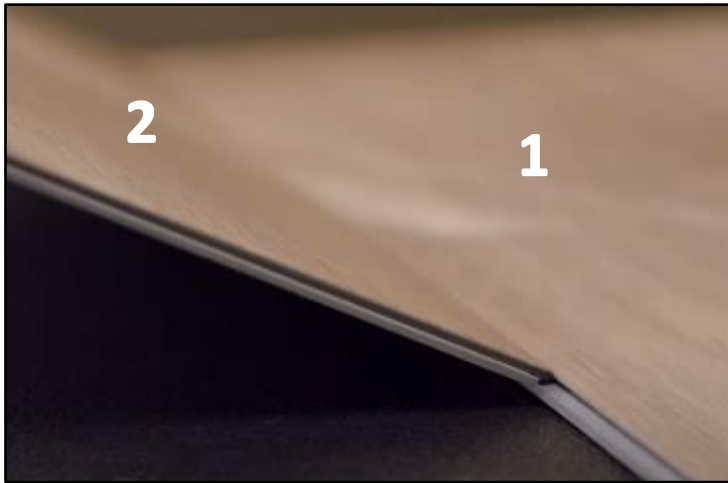

2. Now take a second plank and cut it to a minimum of 1/3 and a maximum of 2/3 of a panel length as a starting plank (n°2) for the second row.

Keep in mind that the minimum distance between all end joints must be at least 30 cm. Place this plank, with the right click connection on the right side, at an angle of  $\pm 30$  degrees, along the longest side, with the tongue in the groove of the first board (n°1) in the first row and then lower it. The planks are now clicked together. Check that the joint closes tightly.

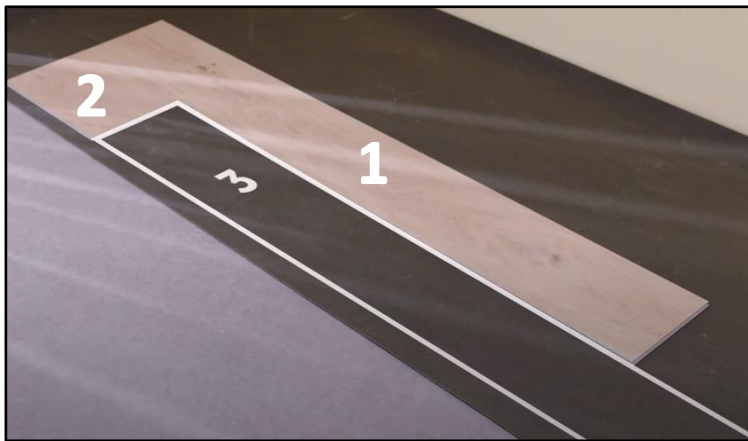

3. Take a third full length plank (n°3) of your choice. Place the board on its end with the tongue in the groove of the board (n°2) at an angle of  $\pm 30$  degrees and then lower it.

Now there's a narrow gap visible between the panel of the first row (n°1) and the one on the second row (n°3). In order to close the gap, lift n°3 at an angle of  $\pm 30$  degrees. Keep this angle while pulling the longest side of board n°3 into the groove of board n°1. Then lower it carefully. The boards are now clicked together. (Also see the advice we explain in 'next rows' when having difficulties with the tongue-and-groove system.)



4. Place a fourth complete plank (n°4), at an angle of +30 degrees, on the long side with the tongue in the groove of the first board (n°1) of the first row and lower it. A narrow gap is now visible between board n°4 and board n°3. To do this, lift board n°4 at an angle of +30 degrees and pull it with the tongue into the groove of board n°3.

This way, you can click the boards together alternately between the first and second row.





**(Advice) Alternative assembly method:**

*A floor board can also be clicked together with the long side first and then with the short side into the other board. For this last step you can use a tapping block. This can be a short piece of cutting waste that you click onto the plank to be installed. Never hit the click connection directly with a hammer and make sure that the floor is completely fixed! To guide the plank better, you can click a short piece into the next row for guidance.*

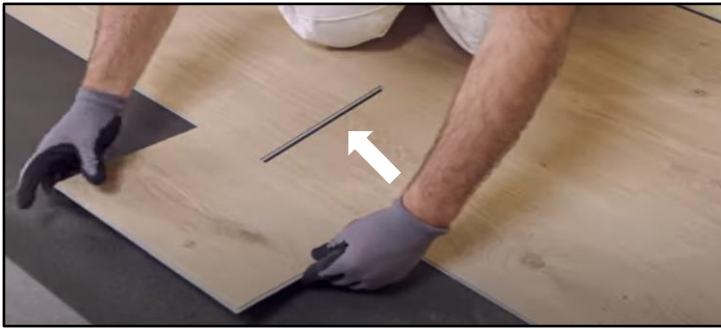

5. Repeat actions 3 and 4 until you reach the end of the first two rows. Then slide the whole thing nicely against the wall. Use spacers to respect the expansion gap of 5 mm. Leave these blocks in place during the entire installation for an optimal and linear straight result.

**Advice:** If the contour of the wall is not straight, use the necessary distance blocks to ensure that you start with a straight line.

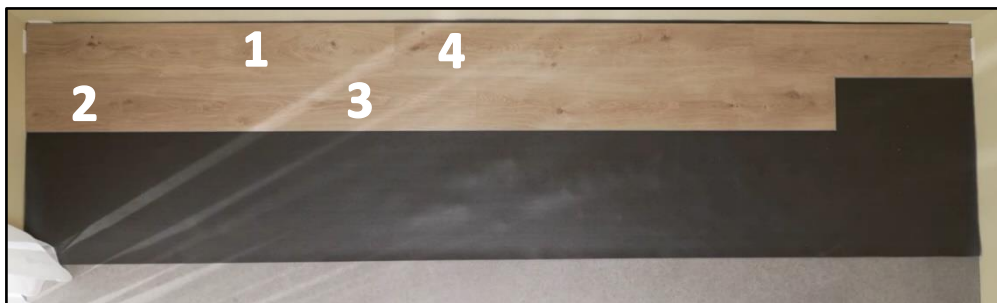

6. It happens often that the last floor panel of each row is too long. Nevertheless, you can easily cut these with a Stanley knife: Lay the floor panel with the decor side up. Use a carpenter's square, measurer or another floor panel to cut along in a straight line. Cut with the knife two or three times over the piece to be shortened. Then turn the floor panel and break off easily the cut off piece. Is the piece to be breached off too small? Then use a pair of pliers. If desired, you can also cut off the long piece of the panel with a hand, electric or jigsaw power tool. Replace the blades or saws if they are blunt.

To measure the correct distance of the plank to be installed, measure from the decorative side of the plank that is already in place to the distance block on the wall.



7. From the third row onwards, place the planks row by row. Make sure that you place enough spacers in the expansion joints so that the floor does not shift. Use a varying mix of decors and planks from different packs.



The following advice can certainly help you to achieve a beautiful end result.

A remaining piece of a floor panel from the previous rows can serve as a starting panel for a next row. Make sure you respect the 30cm distance between the short sides.

To avoid a trapezoidal effect, do not use a surplus in the next row, but in the following rows after that row.



Always ensure that the ends of the planks in two successive rows are the same and that the distance between the short ends is at least 30 cm.



Step on the rows that have already been installed, this will make further installation easier.

You can 'fix' the already installed floor not only with spacers, but also by placing a number of packs on top of it. This will prevent the floor from shifting.

Make sure that there are no identical decors next to each other. Mix the planks and decors from different packs. Check each row and change planks where necessary.

## **PART 2: INSTALLATION OF THE LAST ROW**

1. For the installation of the last row, you will have to saw the boards lengthwise. You can use a metal striking bar to insert the boards into the click system of the previous row. Please note: hitting the boards too hard or too unevenly can damage the boards and their click connections.

You can use the following advice to determine the width of the last row:

Place the plank you are going to install exactly on top of the penultimate row. On top of this plank, lay another, full-length plank, which you will push up against the wall.

Now use this last plank to mark the distance to the wall on the plank to be used and saw it. The tongue and groove of the top plank provides the extra 5mm clearance for the expansion joint.

2. To finish the floor, remove all spacers after laying the last row and install the skirting boards. Attention: never attach the skirting boards to the Floorify floor but always to the wall using assembly adhesive. The floor must always be able to expand and contract under the skirting boards.

Never use a silicone sealant or other flexible paste/plastic to fill in the minimum expansion joint of 5mm.



3. Store unused planks or packs for possible future repairs. Store them indoors and horizontally. Floorify cutting waste is 100% recyclable and can be brought to your local waste centre.

## **OBSTACLES**

### ***Difficult-to-reach places***

In places where it is difficult to tilt the panels, for example beneath radiator, use a pull bar to pull the floor panels together. It is also possible to knock the panels together using a tapping block. Make sure that the floor is sufficiently firm.

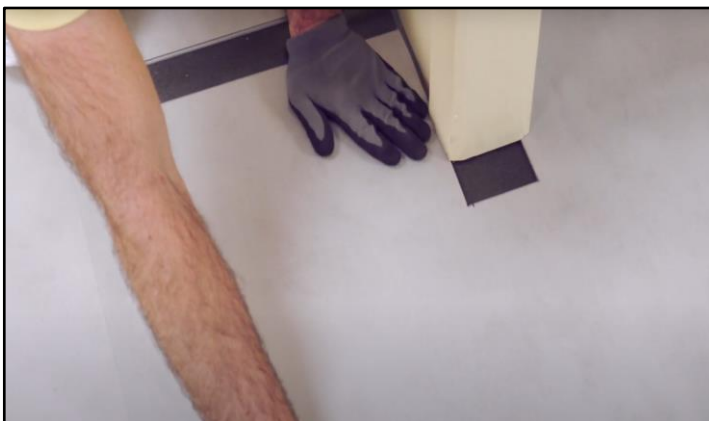

### **Door frames**

Where the new Floorify floor meets a threshold or door frame, we recommend shortening the frame and laying the floor underneath it for the best result. To determine the correct height, you can turn a plank, together with a piece of Floorify underlay, upside down and lay it on the screed against the door frame. Use a handsaw or multi-tool flat against the board and cut through the frame. Remove the cut-outs and vacuum the remains away. You can now fit the floor board by clicking and using the tapping blocks.



### **Pipes**

In rows where there is a pipe, make sure the pipe falls exactly in line with the short side of two panels. Take a drill bit with a diameter equal to the diameter of the tube and add 10 mm. Click the boards together on the short side and drill the opening with the centre at the joint of the two boards. Now place the floor boards on the screed around the tube.

If you cannot position the tube at the short side, the board will have to be cut in two by the centre line. The two pieces are fixed by the surrounding boards. You can also apply some superglue to the side. Tape off the top of the board to avoid glue residue.



In case of a double pipe, drill a hole with the same diameter as the pipes at all the marked points, adding 15 mm. If the pipes are on the long side of the board, make a 45 degree cut from each hole to the side of the board.

Apply suitable adhesive to the cut edges of the piece and glue it in place. Make sure that no glue gets between the cut piece and the screed. Advice: cover the top of the boards with some tape.



## PREVENTION

You can walk on the floor during and immediately after installation. Due to the extra coating of the top layer, special treatment after installation is not necessary. This coating protects your Floorify floor against dirt and makes maintenance easier.

### *Some precautions*

Some simple precautions help you to maintain the aspect and maximize the life cyclus of your Floorify floor.

### *Cleaning mat*

Most of the pollution comes from an external source. Avoid entering dirt, water and sand by placing an **adapted foot mat**, on all entrances. This not only helps to prevent damage to your floor, it also facilitates maintenance and extends the life of your Floorify floor. When choosing a floor mat, please note that the backing of the mat **does not consist of rubber or latex**. These can cause discoloration of the Floorify floor.

### *Protect sliding furniture*

Always protect furniture and chair legs with **high-quality, soft protective caps or felts**. Check regularly for wear and tear or dirt. Keep them dry and replace them if necessary.

Accumulated dirt under sliding furniture **can cause damage and scratches**. Incorrect hard caps can also be detrimental to the surface of the floor.

### *Wheels*

Place **soft, wide wheels** that are suitable for vinyl/ PVC floors under your (office) chairs and armchairs and/or use a suitable desk floor mat for extra protection.

Never use small, thin, hard wheels. They pose a great risk of **point loading** on the click joint, which could result in damages to the click system.

**Moving furniture**

Never drag heavy objects or furniture over the floor, but lift them up.

**Avoid discoloration**

Every floor covering discolors under the (long-term) influence of sunlight, whether this is parquet, laminate, PVC/vinyl or carpet. This is caused by the UV radiation in the sunlight. **Good sun protection is important to avoid discoloration.**

**Fireplace**

Floorify floors can be installed in rooms with a fireplace. However, you should take the heat radiation into account.

If the fire is very close to the floor, use a **fire plate or fire-resistant mat** so that the zone in front of the fire is shielded from direct heat radiation. If you do not do this, the temperature in the area in front of the fire can rise too high and damage the floor.

Do not bring cigarettes, matches or any other hot objects into contact with the floor. These can cause permanent damage.

**Vacuum cleaner**

Use a quality vacuum cleaner **with a soft brush and check that the wheels rotate smoothly** to avoid scratches.

**Avoid contact with rubber**

In the case of prolonged contact between vinyl/PVC and rubber or latex, **a permanent dark-brown discoloration may occur due to migration** (such as a rubber ring under a trash can, rubber doormats, bicycles, etc.). Rubber caps under furniture can also cause streaks due to friction. We therefore recommend that you check all furniture and all utensils for rubber caps and provide them with the correct protection.

## MAINTENANCE

Thanks to the additional, innovative coating of the top layer, no special treatment is required after installation, in contrast to parquet or linoleum where this is required.

This coating protects your Floorify floor against dirt and makes it easier to maintain.

**Cleaning**

- First remove all coarse dirt and dust from the floor with a soft brush or vacuum cleaner with a soft head
- Floorify is very easy to clean. The floor does not have to be cleaned with abundant water. Clean the floor with a wrung-out, clean mop.
- Repeat this at least twice or as much as necessary until the water remains clean.
- Then mop your Floorify floor with clean water.
- Leave the Floorify floor as dry as possible.

**Maintenance products**

- If an additional cleaning product is used, choose a pH-neutral product (pH 7). For example the Floorify cleaner Conny.

Aggressive products can corrode the topcoat of the Floorify floor and cause damage. Never use maintenance products that contain wax or oil. Do not use vinegar, polishes, abrasives, corrosive detergents or solvents.

Floorify cleaner Conny can be used for normal maintenance.

In case of stubborn stains, just after installation and every 4-6 months, we recommend cleaning the floor with the Floorify intensive cleaner Conny Turbo. Read the instructions on the bottle carefully.

#### ***Removing stubborn stains***

- Stubborn stains can be removed with undiluted Conny Turbo or another PH-neutral intensive cleaner suitable for PVC.
- Allow the product to work in for 10 minutes and then scrub the floor with the addition of warm water. Try to exclude excessive use of water so that no water, e.g. via the expansion joints, can get under the floor.
- Pick up deposited dirt with a mop and rinse thoroughly with clean, clear water and a clean mop.

#### ***Superficial scratches or streaks***

- If there are superficial scratches or streaks and natural traces of ageing on the floor, these can be made less visible by using the Conny Care maintenance product.
- The matt protective layer also extends the life of the floor.

#### ***Steam cleaner***

Using a steam cleaner with a wide mouthpiece and in combination with a suitable microfibre cloth can be used. A steam cleaner will not adversely affect your Floorify floor and will therefore not adversely affect the click system, decor, colour or other product properties.

However, you should take a few things into account:

- Avoid direct contact of the steam on your Floorify floor by using the microfibre cloth/pad on the steam opening. This ensures that the steam and heat are evenly distributed.
- Keep the contact of the steam on your Floorify floor as short as possible and set the appliance to the lowest setting.
- It is recommended to clean the floor in the lengthwise direction of the boards.
- Installed skirting boards may come loose due to the combination of steam and heat on the tape used to attach them. If required, stay several cm away from the skirting boards to avoid this.
- Make sure to completely dry the Floorify floor with a dry cloth or mop immediately after cleaning.

Please note: In the case of intensive cleaning, moisture can end up under the floor covering, which can possibly affect the subfloor (wood or anhydrite) in the longer term.

You can find detailed instructions around commercial maintenance on our website.