



PLANKS & TILES

ADVIESVERKOOPPRIJZEN TRAP LANGE PLANKEN

INCL BTW



Z-trap

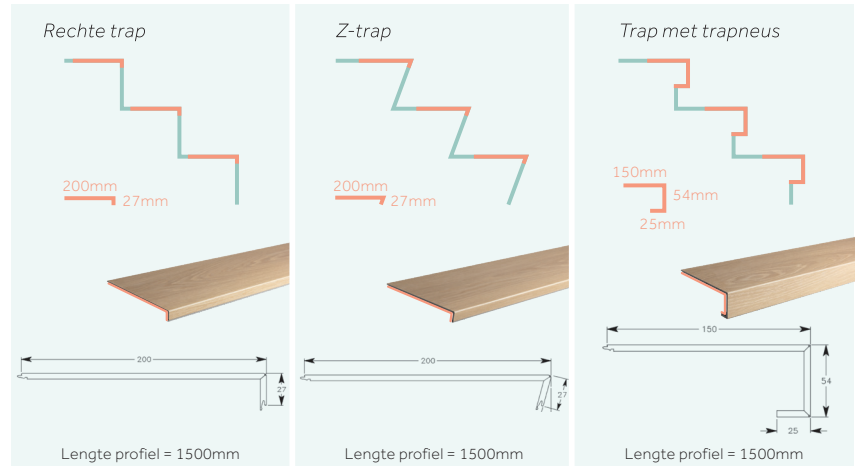

AANTAL TREDEN	PROFIELEN 69.95€ incl. btw/stuk		PLANKEN 54.95€ incl. btw/m ²		TOTALE PRIJS incl. btw, excl. lijm
	AANTAL	PRIJS	AANTAL M ²	PRIJS	
1	1	69,95€	2.74 m ² (=1 doos)	150,56€	220,51€
2	2	139,90€	2.74 m ² (=1 doos)	150,56€	290,46€
3	3	209,85€	2.74 m ² (=1 doos)	150,56€	360,41€
4	4	279,80€	2.74 m ² (=1 doos)	150,56€	430,36€
5	5	349,75€	5.48 m ² (=2 dozen)	301,13€	650,88€
6	6	419,70€	5.48 m ² (=2 dozen)	301,13€	720,83€
7	7	489,65€	5.48 m ² (=2 dozen)	301,13€	790,78€
8	8	559,60€	5.48 m ² (=2 dozen)	301,13€	860,73€
9	9	629,55€	8.22 m ² (=3 dozen)	451,69€	1081,24€
10	10	699,50€	8.22 m ² (=3 dozen)	451,69€	1151,19€
11	11	769,45€	8.22 m ² (=3 dozen)	451,69€	1221,04€
12	12	839,40€	8.22 m ² (=3 dozen)	451,69€	1291,09€
13	13	909,35€	10.96 m ² (=4 dozen)	602,25€	1511,60€
14	14	979,30€	10.96 m ² (=4 dozen)	602,25€	1581,55€
15	15	1049,25€	10.96 m ² (=4 dozen)	602,25€	1651,50€
16	16	1119,20€	10.96 m ² (=4 dozen)	602,25€	1721,45€
17	17	1189,15€	13.70 m ² (=5 dozen)	752,82€	1941,97€
18	18	1259,10€	13.70 m ² (=5 dozen)	752,82€	2011,92€
19	19	1329,05€	13.70 m ² (=5 dozen)	752,82€	2081,87€
20	20	1399€	13.70 m ² (=5 dozen)	752,82€	2151,82€

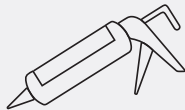

Een Floorify trap dient geplaatst te worden met **Soudabond 680** montagelijm. Er is ook de mogelijkheid tot aankoop van een **lijmpistool**.
Vraag ernaar in uw winkelpunt.

Voorbeeld: trap met 14 treden => 14 stuks profielen (979,30€) + 4 dozen planken (602,25€)