

Grund - Grunnmur - Fundament - Perustus

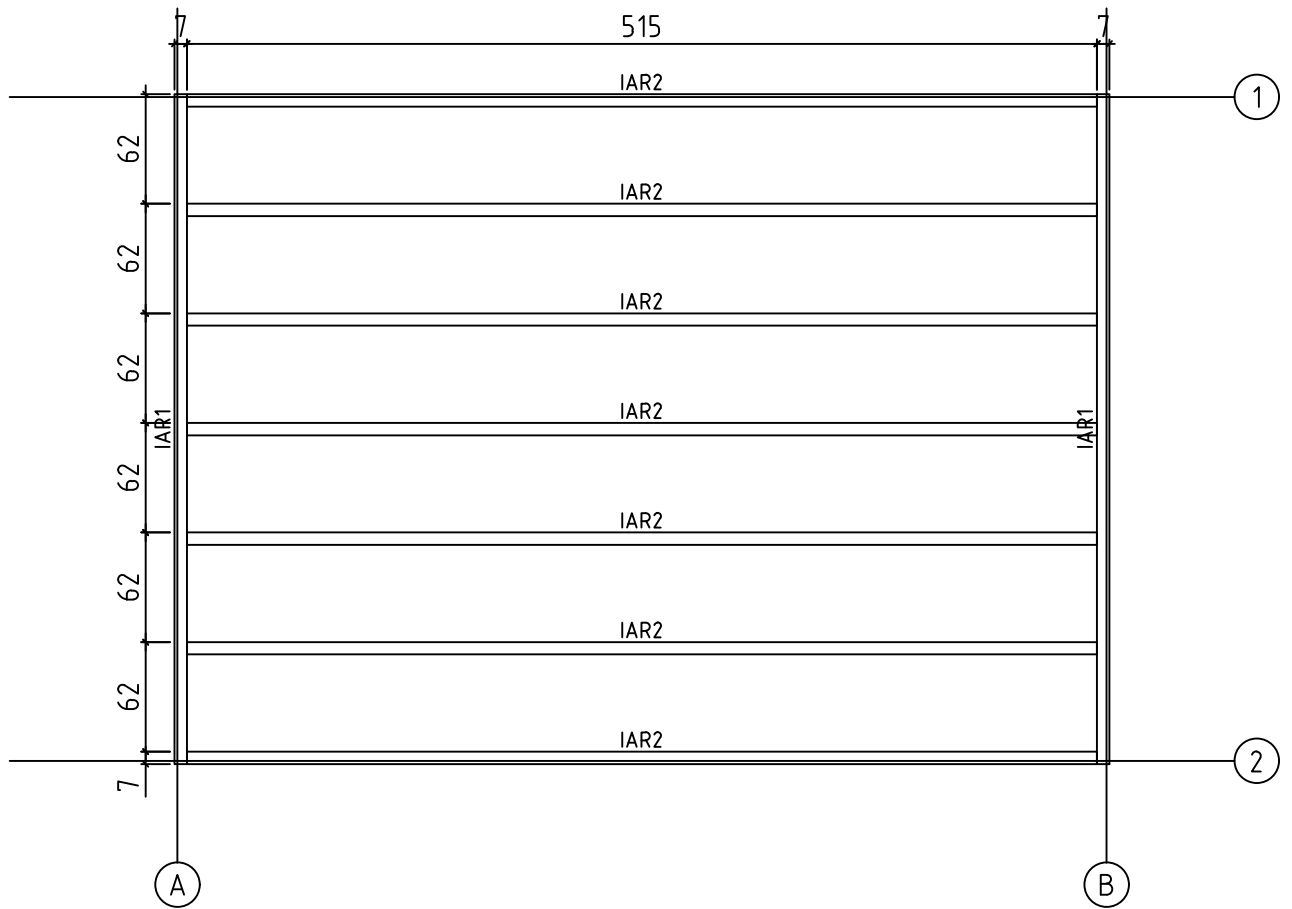

Golvbrädor - Gulvbord - Gulvbrädder - Lattialaudat

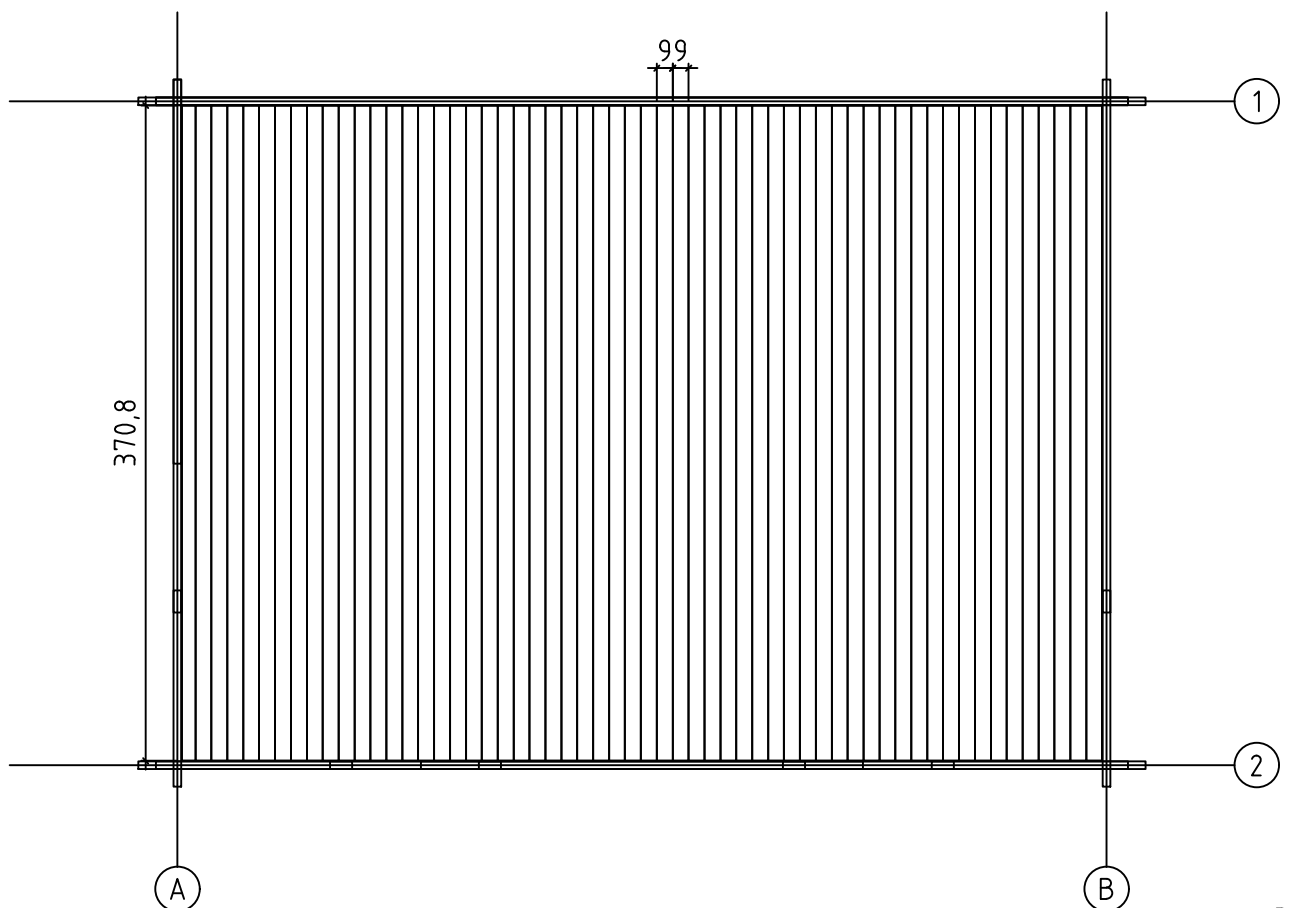



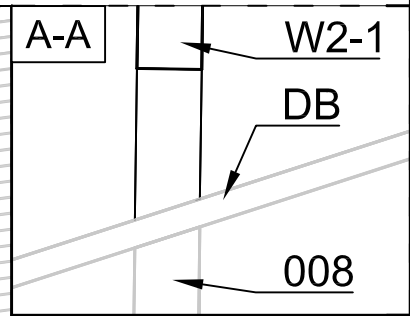
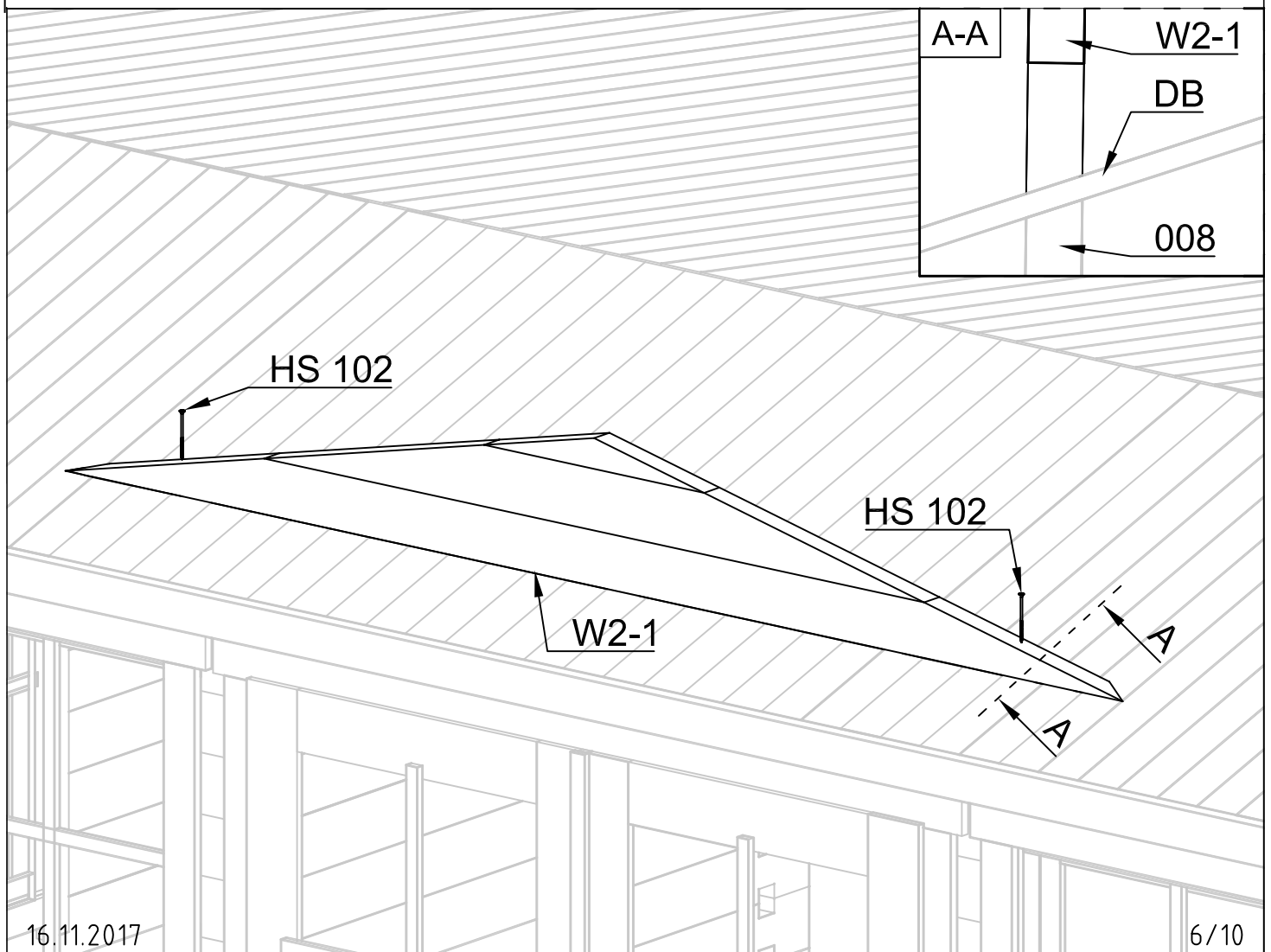
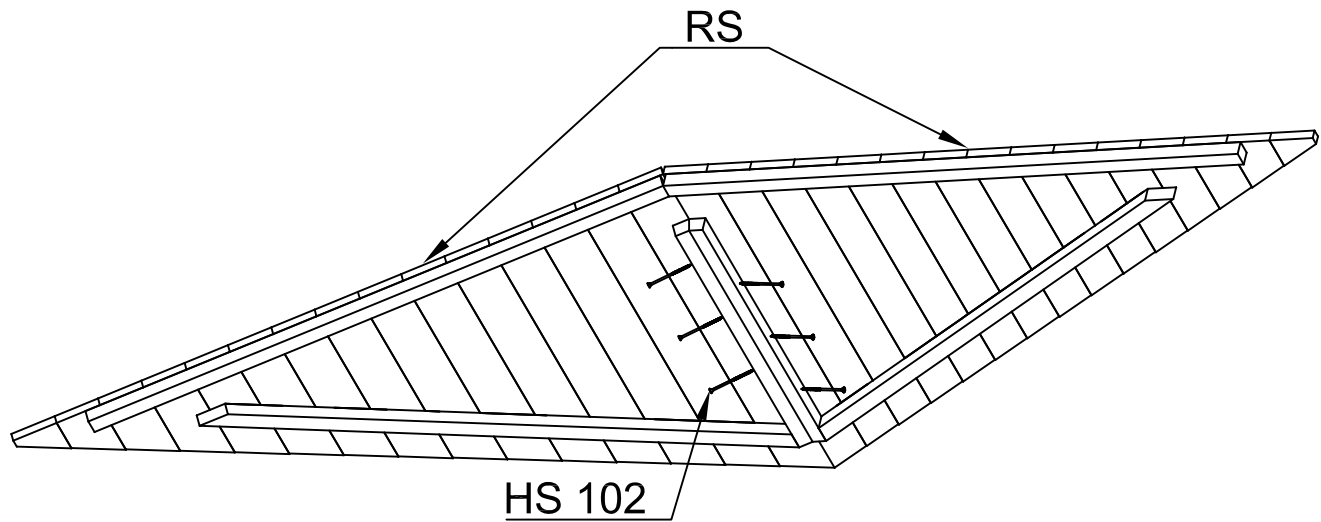

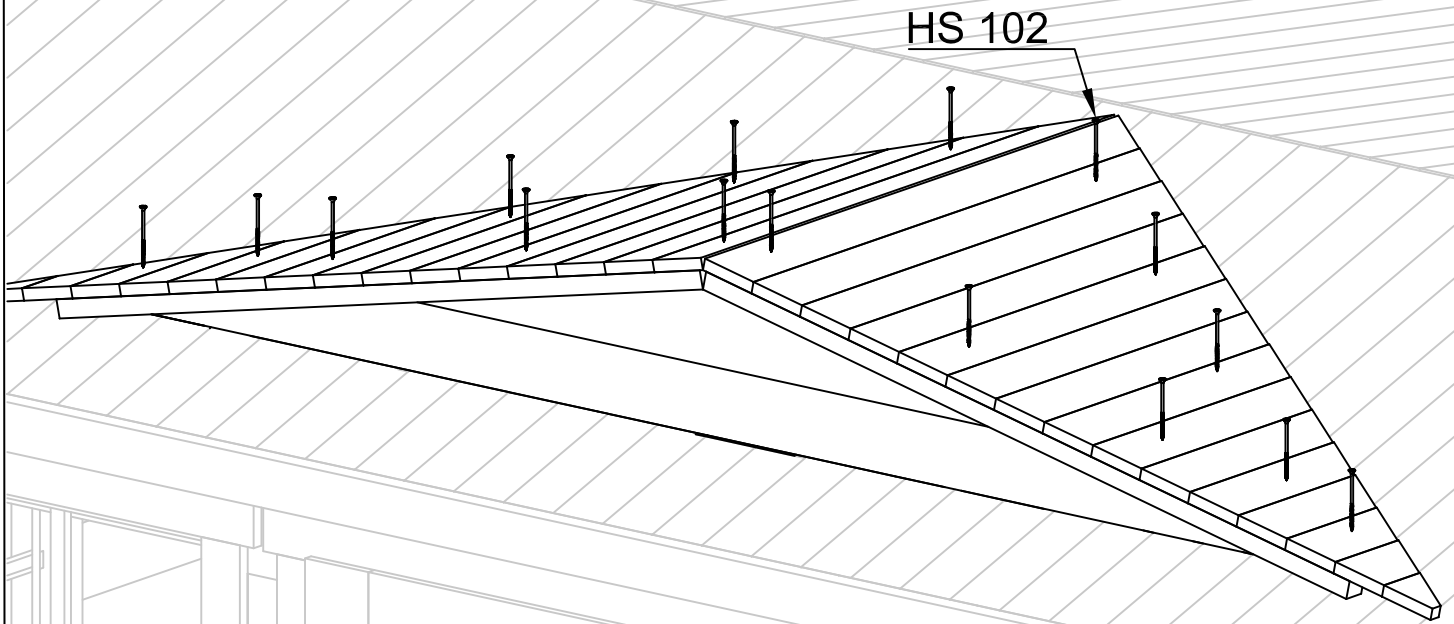
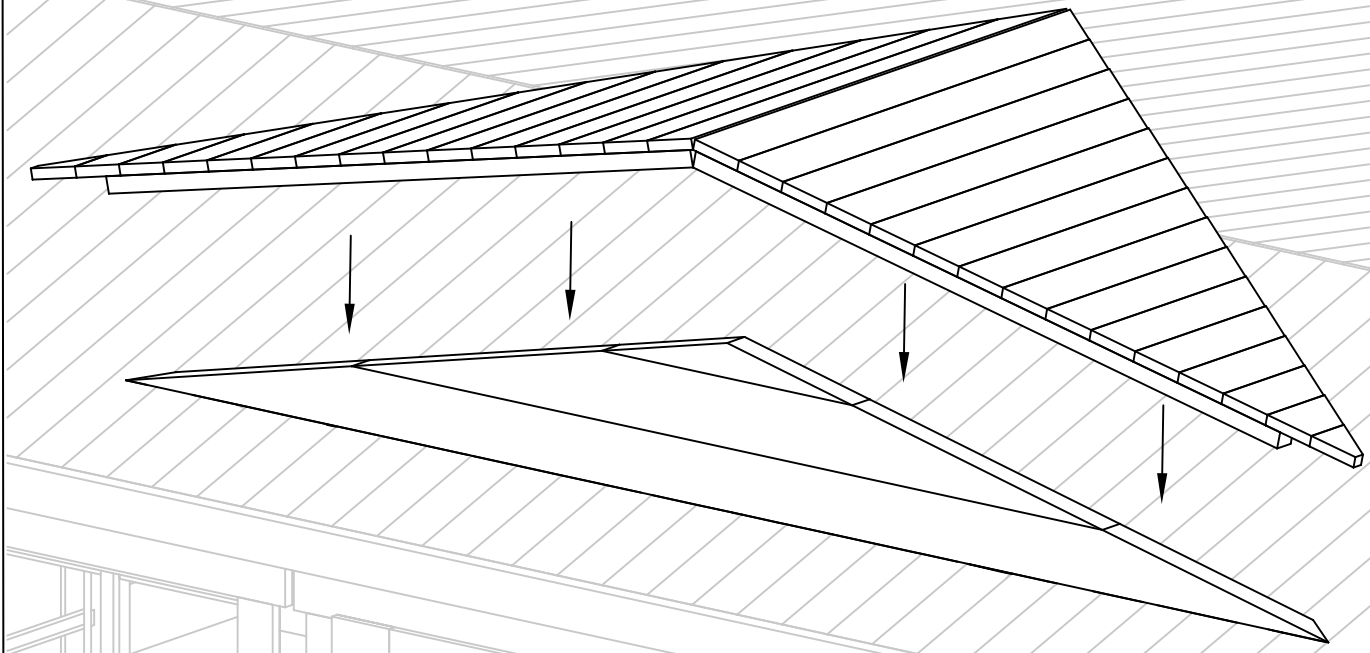







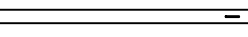

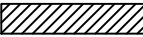
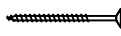
Roofing felt must be applied before applying roof shield elements!





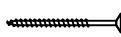
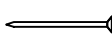

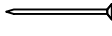
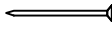
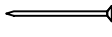
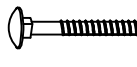

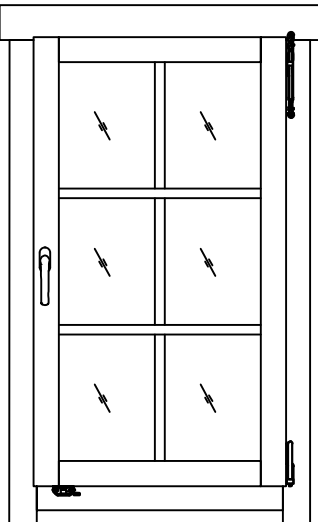
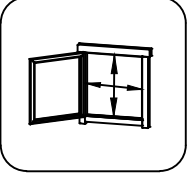
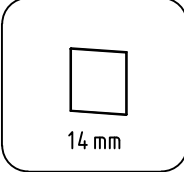
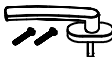
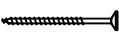

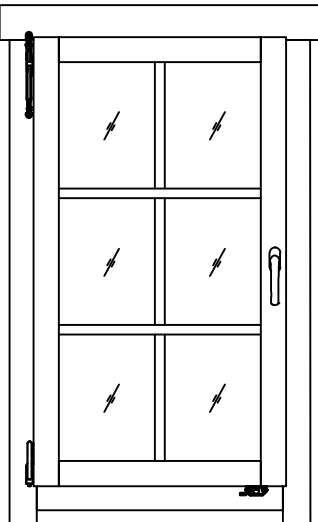
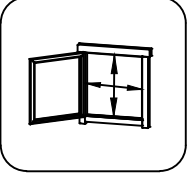
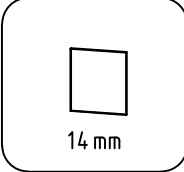

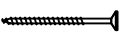
Pos	16.11.2017	Delförteckning - Liste over deler - Styklister - Osaluettelo Art.Nr. 4417040	8/10	Q	P (mm)	L (mm)
001				1	44x57	5500
002				17	44x114	5500
003				1	44x120	5700
004				2	44x57	1952
005				10	44x114	1952
006				33	44x114	268
007				55	44x114	124
008				1	44x120	5700
012				23	44x114	4000
013				11	44x114	2172
W2-1				1		
WA-1				1		
WB-1				1		
IAR2	Grund - Grunnmur - Fundament - Perustus 			7	70x45	5150
IAR1	Grund - Grunnmur - Fundament - Perustus 			2	70x45	3790
A-PR1	Tåkasar - Takbjelke - Tagbjélke - Katto-orret 			4	44x170	5700
	Golvbrädor - Gulvbord - Gulybrödder - Lattialaudat 			58	90x18	3708
	Takbräde - Takbord - Tagbrödder - Kattolauta 			64	90x18	3100
	Takbräde - Takbord - Tagbrödder - Kattolauta 			64	90x18	1200
	Golvläkt - Gulvlist - Gulvliste - Jalkalista 				18x18	17.83
	Takläkt - List for takpapp - Tagpapliste - Kattohuopalista 			2	18x58	1250

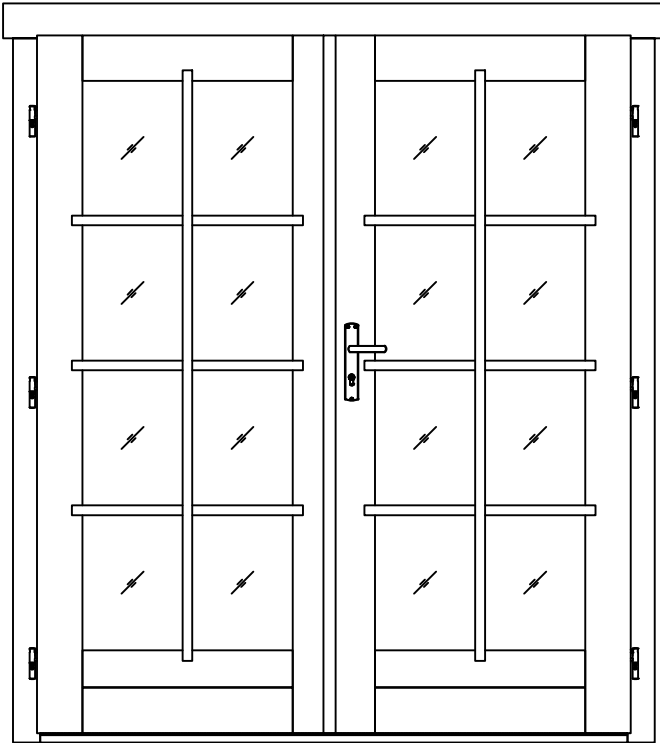
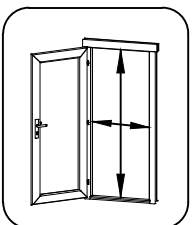
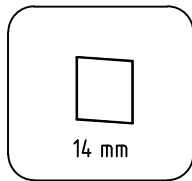
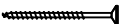
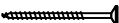
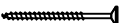
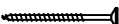
Pos	16.11.2017	Delförteckning - Liste over deler - Stykliste - Osaluettelo Art.Nr. 4417040	9/10	Q	P (mm)	L (mm)
		Takläkt - List for takpapp - Tagpapliste - Kattohuopalista		2	18x58	1370
		Takläkt - List for takpapp - Tagpapliste - Kattohuopalista		2	18x58	3150
TB-1		Takfotsinklädning - Speilbord - Sternbræt - Rästsläuta		4	18x90	2850
DRV-4		Takfot - Forsterkning av takforkant - Tagkantsforstærkning - Rästslästa		4	28x34	2850
KFS-1		Storm säkring - Vindavstivningslist - Stormliste - Myrskysuojalista		4	22x45	2050
		Vindbräde - Vindski - Vindskede - Kaapelilauta		2	18x120	1250
		Vindbräde - Vindski - Vindskede - Kaapelilauta		2	18x120	3150
		Vindbräde - Vindski - Vindskede - Kaapelilauta		2	18x90	1370
HS8		Skruv för gavelsegment - Skruer for gavledel - Skruer til gavlsegment - Koristepalan ruuvi		6	3.5x35	
HS9		Skruv för gavelläkt - Skruer for vindski - Skruer til vindskede - Harjalistan ruuvi		32	3.5x50	
HS12		Skruv för takfotsinklädning - Skruer for speilbord - Skruer til sternbrædder - Rästsläudan ruuvi		34	4x40	
HS12		Skruv för förstärkningsreglar till takfot - Skruer for forsterkning av takforkant - Skruer til tagkantsforstærkning - Katon reunan vahvistusruuvi		94	4x40	
		Kruvi 4x60 kilbi montaaiziks		24	4x60	
HS18		Skruv för takbjälkar - Skruer for takbjelker - Skruer til tagbjelker - Kattopalkin ruuvi		12	5x120	
HS16		Skruv för 1. väggregel - Skruer for f,rste stökklag - Skruer til f,rste vögbjälke - 1. seinäpalkin ruuvi		8	5x90	
HS16		Skruv för grund - Skruer for grunnmur - Skruer til fundament - Perustuksen ruuvi		14	5x90	
NF2		Zn spik för golvläkt - Sinkstift for gulvlist - Zn s,m til gulvliste - Sinkitty naula jalkalistan asennukseen		36	1.4x40	
SH44		Hammarkloss - Hoggestabbe - Træklods til hamring - Naulauskappale		1		
SFS		Mutter för strömsäkring - Mutter for vindavstivningslist - M,tryk til stormliste - Myrskysuojalistan mutteri		8	D8	
NF4		Förzinkad takspik - Sinkspiker for tak - Zn s,m til tag - Sinkitty kattonaula		398	2x50	
NF4		Förzinkad golvspik - Sinkspiker for gulv - Zn s,m til loft - Sinkitty lattianaula		531	2x50	
NF5		Förzinkad spik för takläkt - Sinkspiker for takpappliste - Zn s,m til tagpapliste - Kattohuopalistin sinkitty naula		22	2x40	
BFS		Bult för strömsäkring - Bolt for vindavstivningslist - Bolt til stormliste - Myrskysuojalistan pultti		8	8x80	

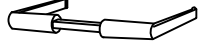
Pos	29.08.2017	Delförteckning - Liste over deler - Stykliste - Osaluettelo 710x1224 AK.1.106.TPSP DGP+	1/1	Q	P (mm)	L (mm)
						
						
			610x1128 mm			
						
			14 mm			
			540x1046 mm			
FS2	Handtagsbeslag för fönster - Vridere til vinduer - Vindueshåndtag - Ikkunanpainikkeet			1		
HS1	Skruv för spröjs - Skrue for sprosser - Skrue til sprosser - Jakopuitteen ruuvi			6	2.5x20	

Pos	29.08.2017 Delförteckning - Liste over deler - Styklister - Osaluettelo 710x1224 AK.1.106.TPSV DGP+	1/1	Q	P (mm)	L (mm)
				 <p>610x1128 mm</p>  <p>14 mm</p> <p>540x1046 mm</p>	
FS2	Handtagsbeslag för fönster - Vridere til vinduer - Vindueshåndtag - Ikkunanpainikkeet		1		
HS1	Skruv för spröjs - Skruer for sprosser - Skruer til sprosser - Jakopuitteen ruuvi		6	2.5x20	

Pos	13.11.2017	Delförteckning - Liste over deler - Stykliste - Osaluettelo 1588x1850 TUK.1.108.TPVP.MMa DGP+	1/1	Q	P (mm)	L (mm)
						
					 1488x1766 mm	
					 14 mm	
					561x1486 mm	
HS1	Screw for georgian bars - Schraube für sprossen - Vis pour croisillons - Viti per unire la griglia georgiana della finestra - Schroeven voor raamverdeling - Kruvi ukse petteliistule		16	2.5x20		
HS4	Skruv för golvläkt - Skruer for dørliste - Skruer til dørliste - Ovilistan asennusruuvi		5	3x30		
HS16	Skruv för dörrkarm - Skruer for dørstolpe - Skruer til dørkarm - Oven karmin ruuvi		4	5x90		
HS25	Skruv för dörrtröskel - Skruer for terskel - Skruer til dørtrin - Kynnyksen ruuvi		3	4.5x65		
MH	Gångjärn för dörr - Bolt for dørhengsel - Hanskrue til dørhengsel - Oven sarana		6	14x80		
HC	Gångjärnskaopor för dörr - Deksel over hengsle - Hængsel-dæksel - Oven sarana suoja		12			
TL4	Handtag för dörr - Dørbeslag - Dørhåndtag - Ovenpainike		1			
TL5	Sats med täckbrickor för dörrlås - Et sett av dørbeslag - Sæt af låsedæksler - Lukkokilpisarja		1			
	Cylinder - Sylindrelås - Cylinderlås - Sylinterilukko		1	30x35		
	Låsets slutstycke - Fallelåsens sluttstykke - Låsens slutstykke - Ovensalvan vastakappale		2			