

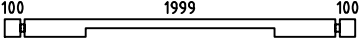

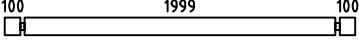

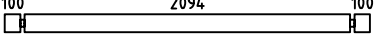

Malte28

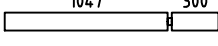
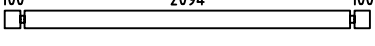
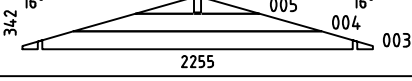
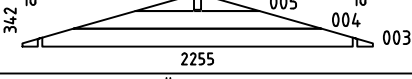
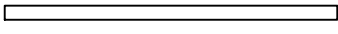
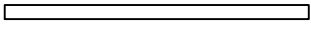
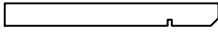
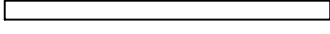

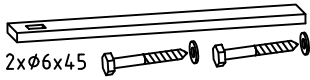
Pos	Specification-Spezifikation-Specificatie-Nomenclature-Elementi-Especificacion Malte28	Qty	Profile (mm)	Lenght (mm)
001		32	28x114	520
002		1	28x114	2255
006		17	28x114	2255
007		2	28x57	2350
008		32	28x114	2350
009		2	28x114	1375
010		2	28x114	1375
EXTRA		1	28x114	2350
W1-1		1		
W2-1		1		
F1	FOUNDATION-GOLVBJÄLKE-FUNDAMENT-FONDATION 	2	44x90	2140
F2	FOUNDATION-GOLVBJÄLKE-FUNDAMENT-FONDATION 	2	44x90	1957
PL1	PURLIN-TAKBALK-DACHPFETTE-PANNE 	2	44x144	1375
S1	SUPPORT-STÖD-STÜTZEN-SUPPORTO-SOPORTE 	2	28x120	2094
R-1	ROOF BOARD-TAKBRÄDA-DACHBRETT-VOLIGE 	64+1 50+1	88x18 114x18	1330
GB-1	GABLE BOARD 95-GAVELBRÄDA-GIEBELBLLENDE-PLANCHE DE RIVE 	4	18x95	1375
GB-1	GABLE BOARD 120-GAVELBRÄDA-GIEBELBLLENDE-PLANCHE DE RIVE 	4	18x120	1370
RL-1	ROOFING LATH 2000-TAKLÄKT-GIEBELLEISTE-LATTE DE RIVE 	6	40x18	12rmt.
SS-1	STORM SLAT KIT-STORMSÄKRINGSLIST-STURMLEISTE SATZ-KIT DE LATTE ANTI TEMPÊTE 	4	18x40	2000
D	DIAMOND-DIAMANT-DECKBRETT-LOSANGE DE DECORATION 	2		
	DOOR KIT-DÖRR BESLAG-TÜR SATZ-KIT PORTE 	1		
N 1.8x40	NAIL 1.8x40-SPIK-NAGEL-CLOU 	140	1.8x40	
S4x60	SCREW 4x60-SKRUV-SCHRAUBE-VIS 	60	4x60	
Model	Malte28	Material	Page	1/2

H = 1.600 m
 TOTAL: 4.19 m²

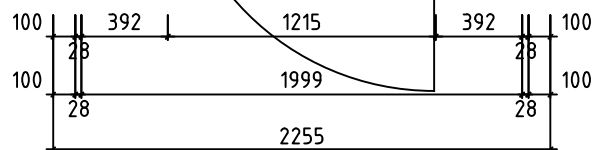
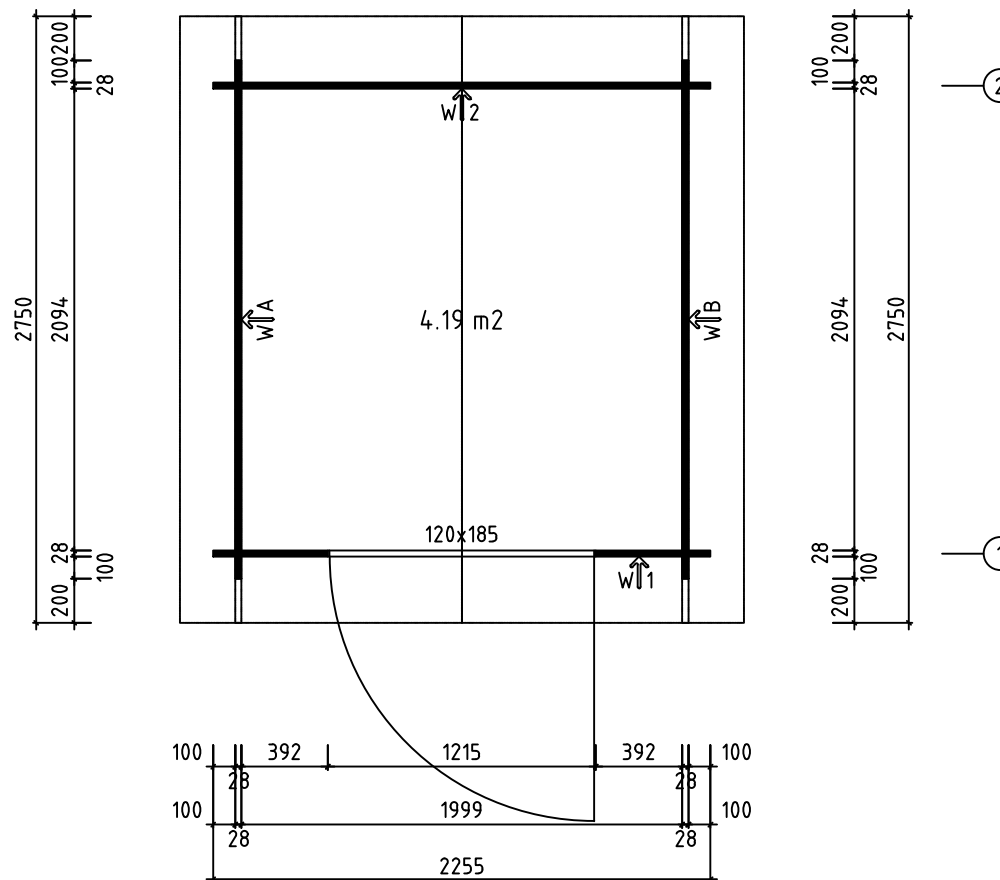
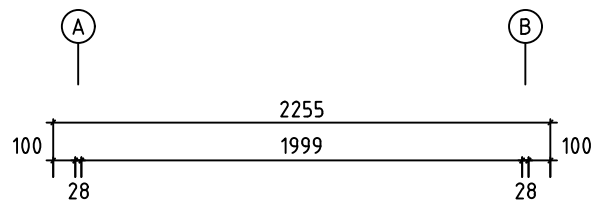

Model	Malte28	Page
Drawing	PLAN	Scale 1:30
Material	28x114	Date 20.01.2023
File	Malte28.dwg	Drawn by

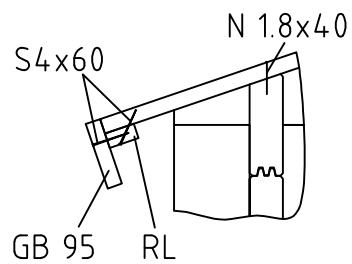
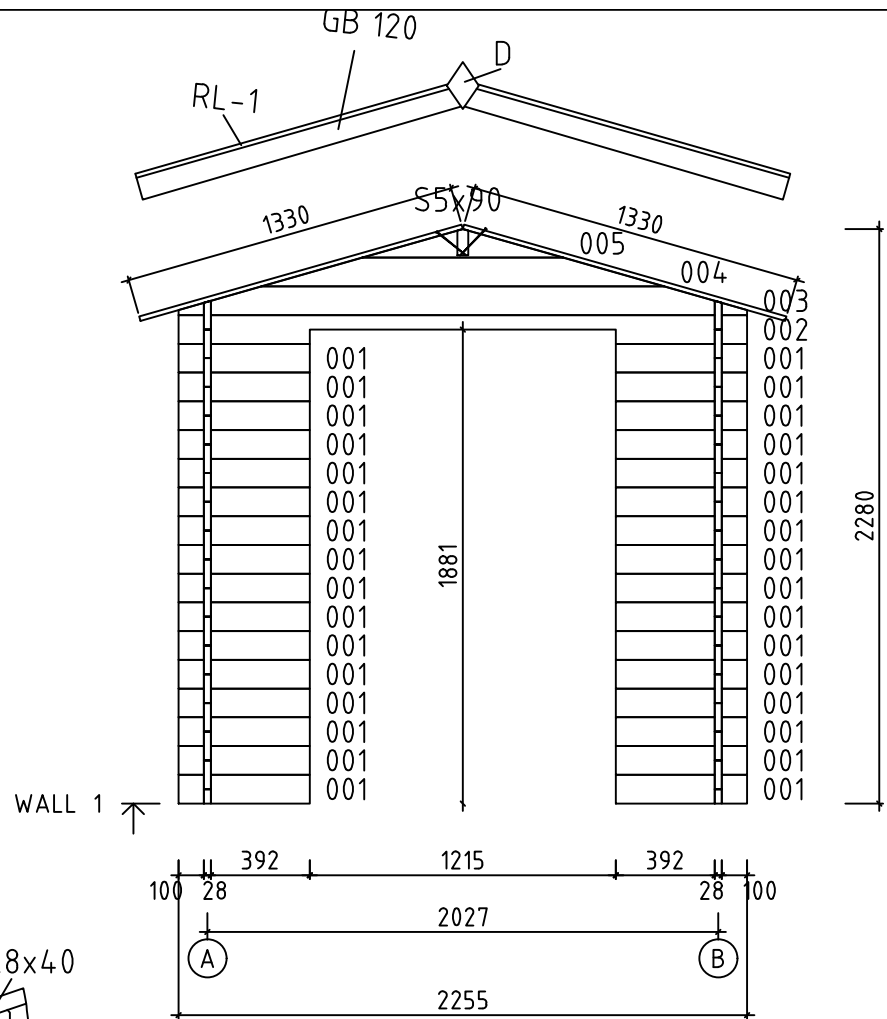

Model	Malte28	Page	6
Drawing	WALL 1	Scale	1:30
Material	2.8x11.4	Date	20.01.2023
File	Malte28.dwg	Drawn by	

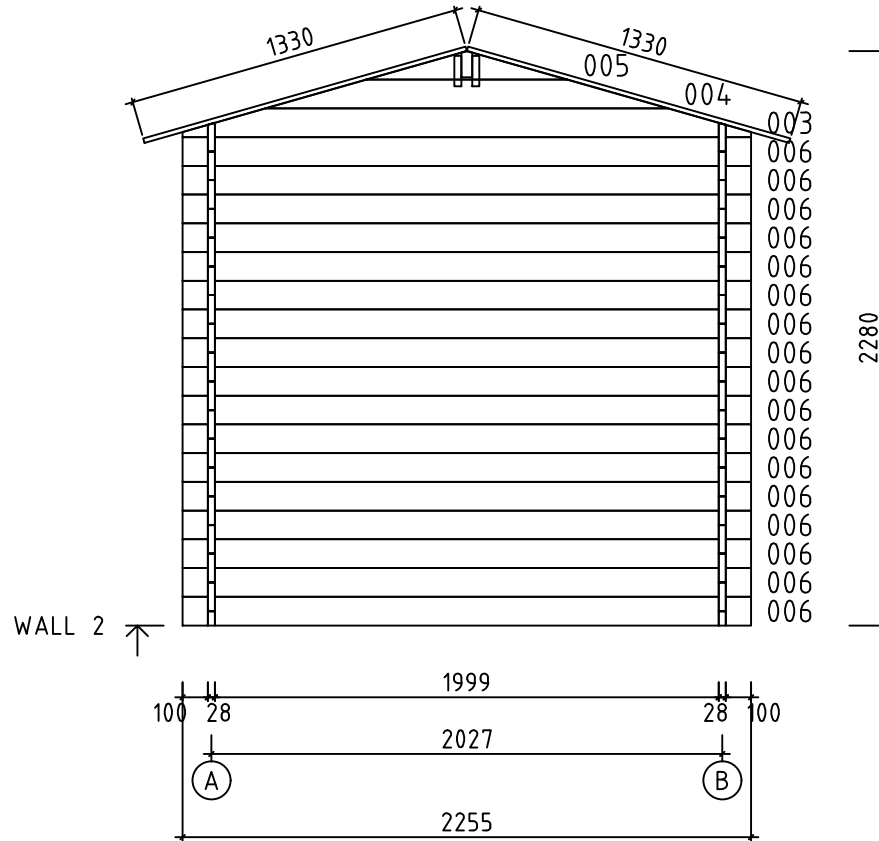

	Model	Malte28	Page	7
	Drawing	WALL 2	Scale	1:30
	Material	2.8x11.4	Date	20.01.2023
	File	Malte28.dwg	Drawn by	

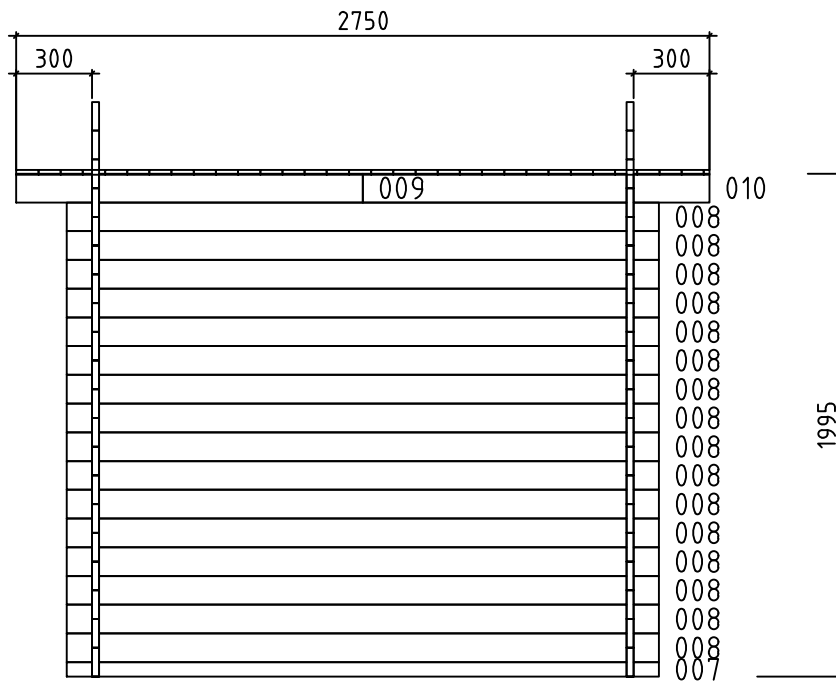

WALL A ↗

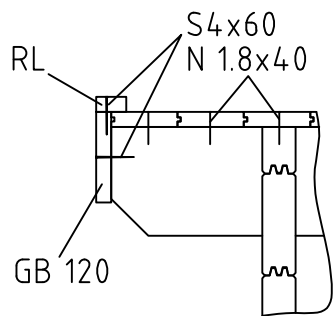
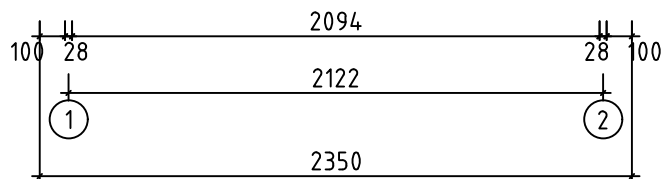

Model	Malte28	Page	3
Drawing	WALL A	Scale	1:30
Material	2.8x11.4	Date	20.01.2023
File	Malte28.dwg	Drawn by	

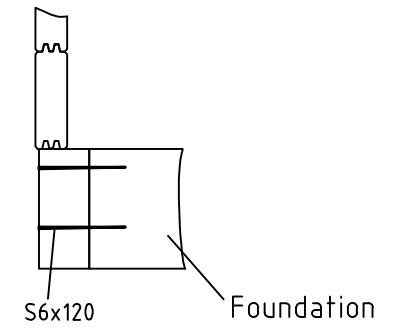
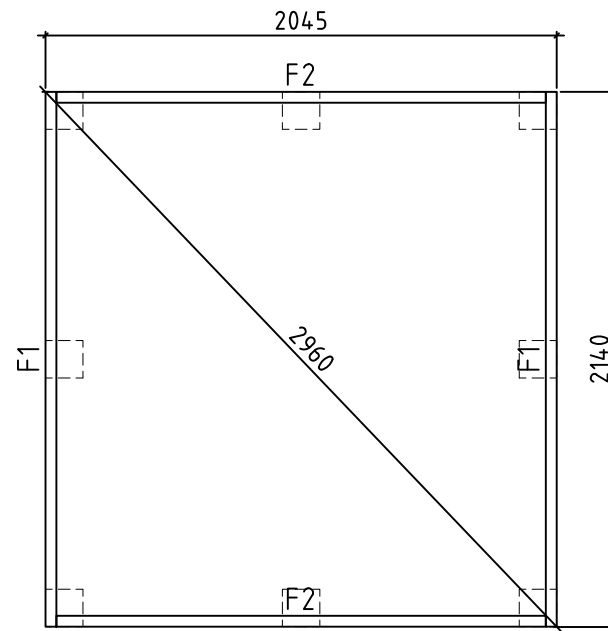

	Model	Malte28	Page
	Drawing	FOUNDATION-PLINTH PLAN	Scale 1:30
	Material	28x114	Date 20.01.2023
	File	Malte28.dwg	Drawn by

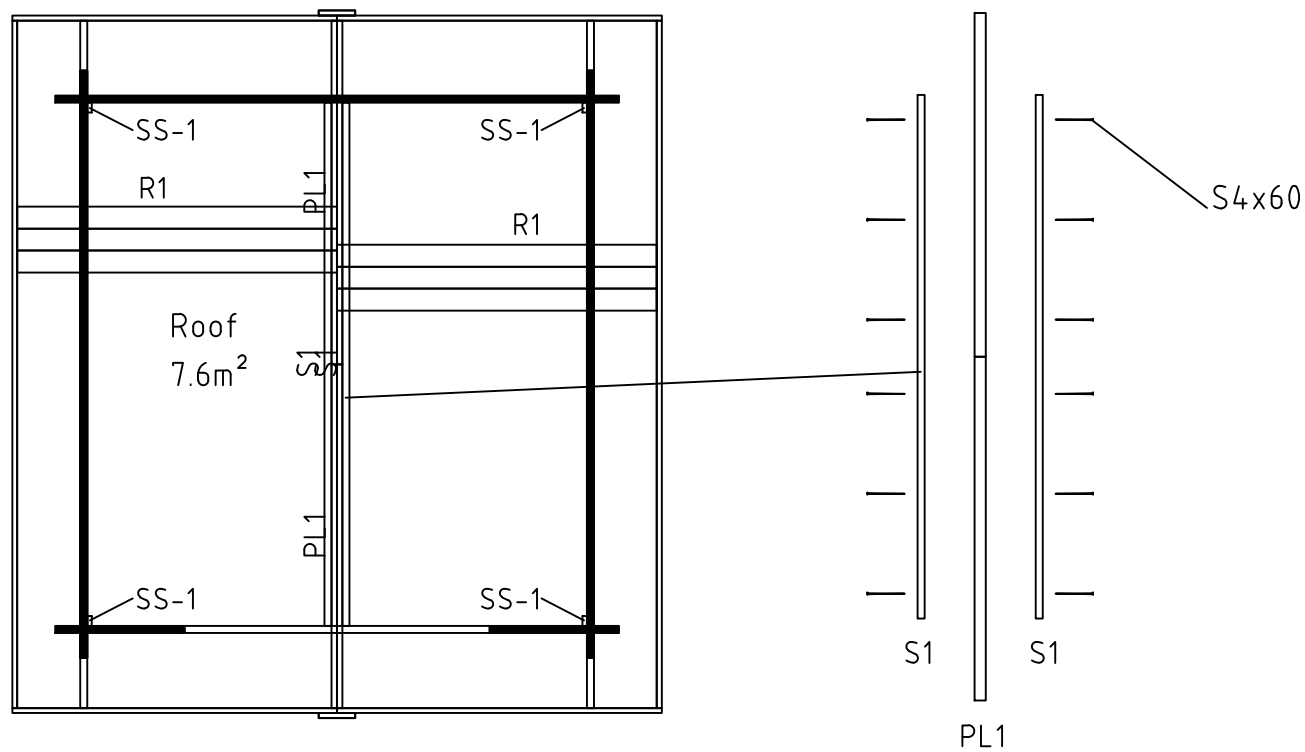

Model	Malte28	Page
Drawing	ROOF	Scale 1:30
Material	28x114	Date 20.01.2023
File	Malte28.dwg	Drawn by

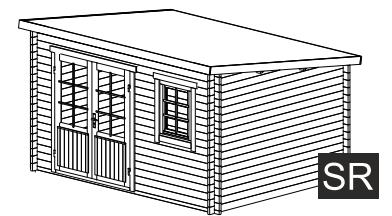
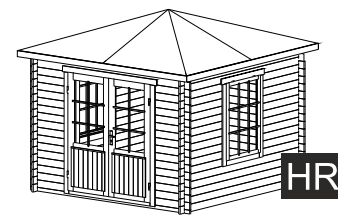
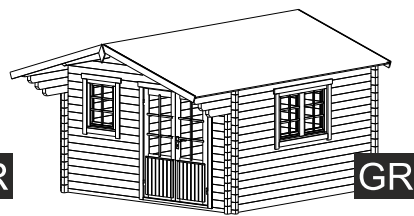
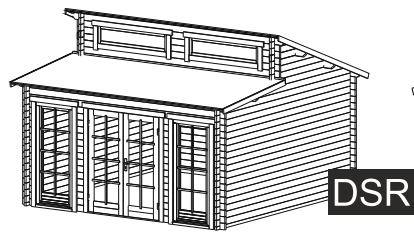
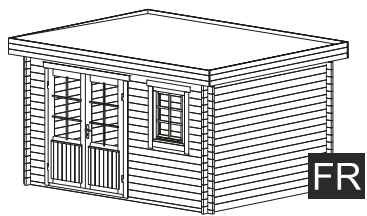

FR

DSR

GR

HR

SR

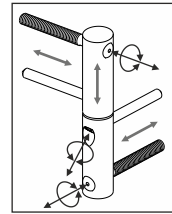
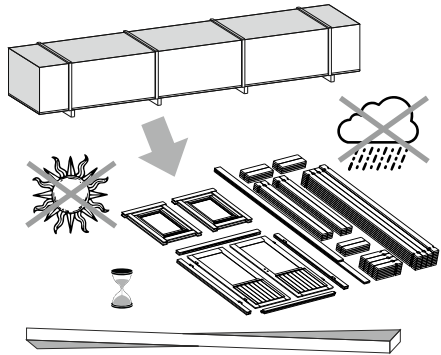

ADJUSTABLE HINGES

3.

TYPE-A
5x90

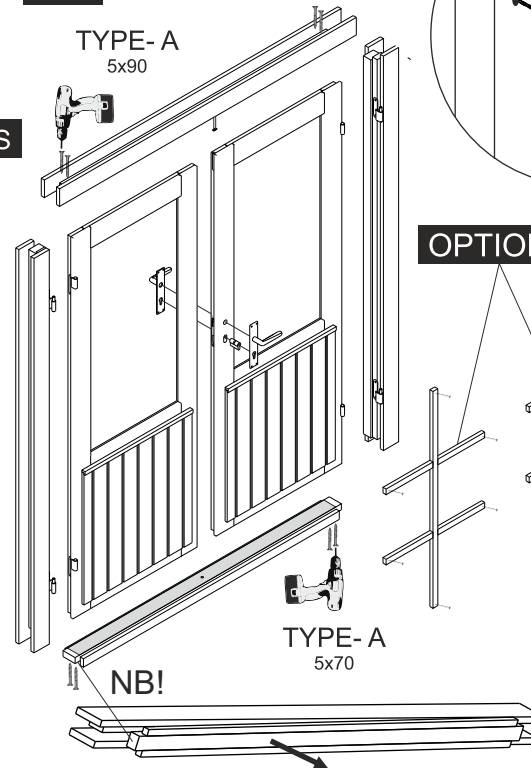

OPTIONS

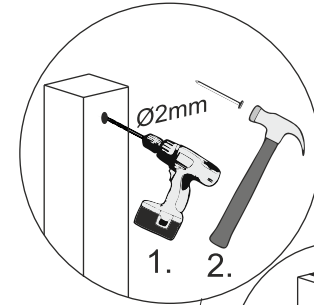

1. 2.

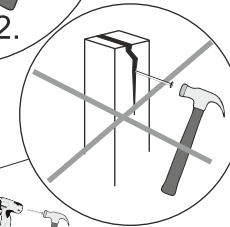

4.

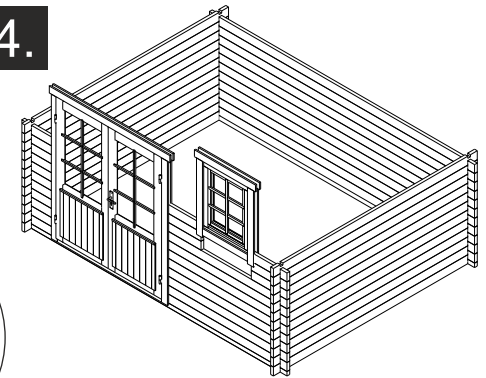

1.

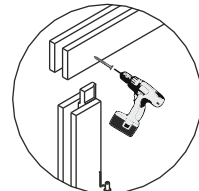
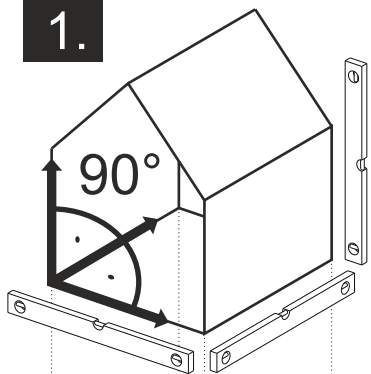

TYPE-B
4x60

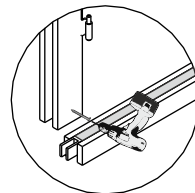

5.

OPTIONS

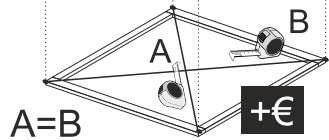
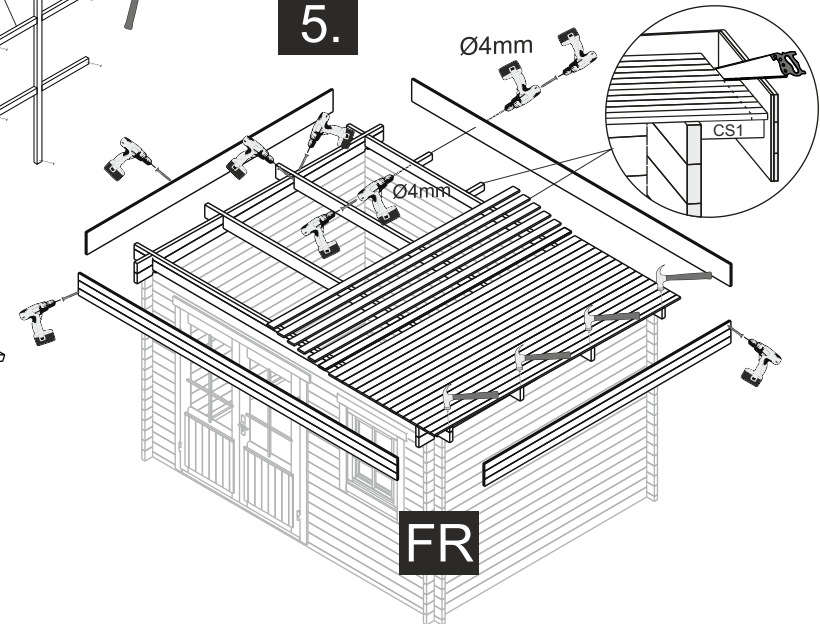

+€

2.

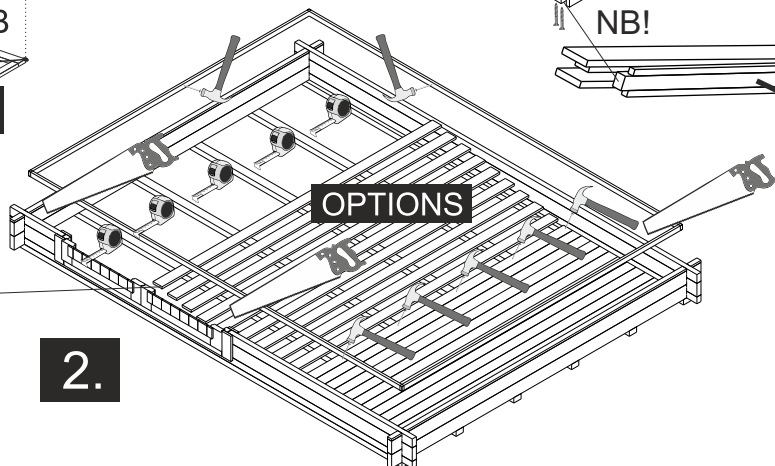

OPTIONS

NB!

TYPE-A
5x70

The guide is illustrative. This guide is not project specification.
Der Leitfaden ist illustrativ. Dieser Leitfaden ist keine Projektspezifikation.
De gids is illustratief. Deze gids is geen projectspecificatie.

5.

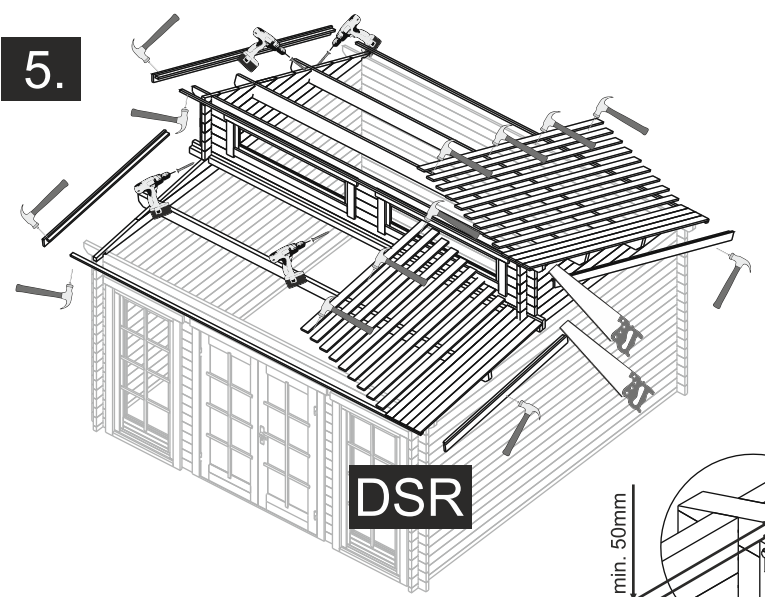

5.

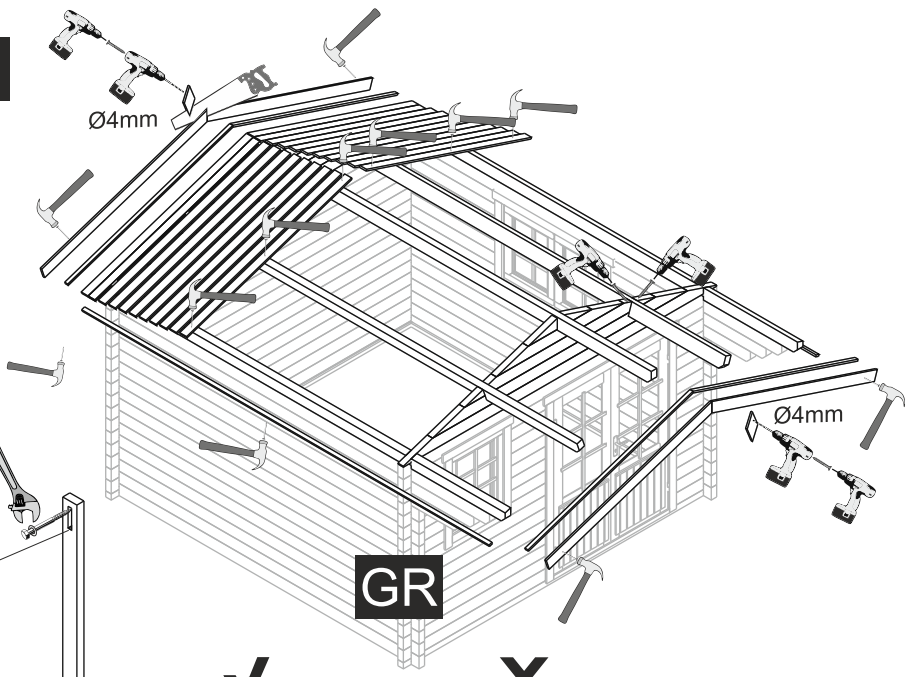

OPTIONS

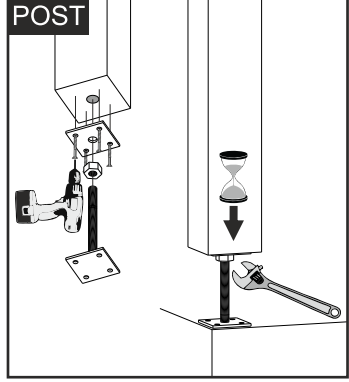
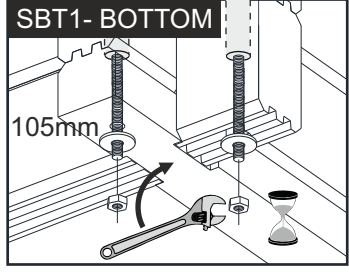
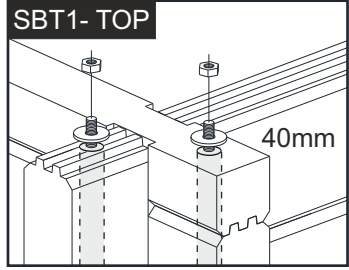
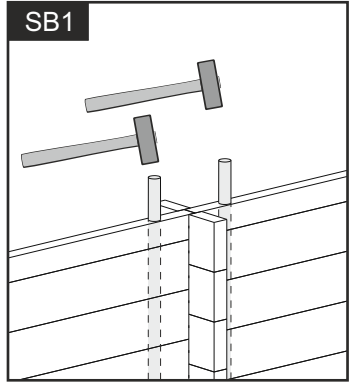

NB!

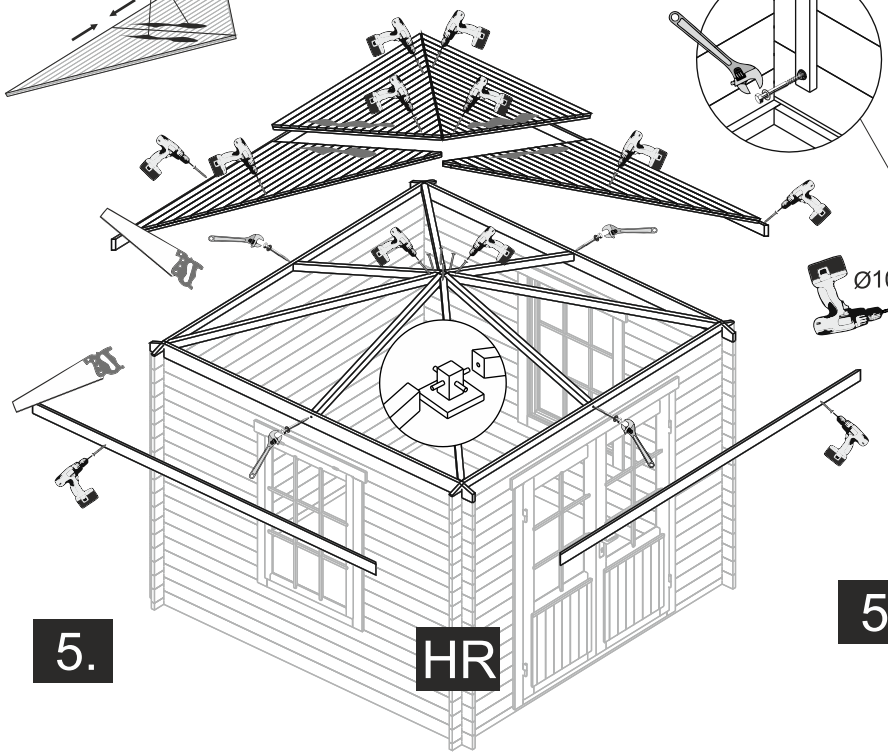

5.

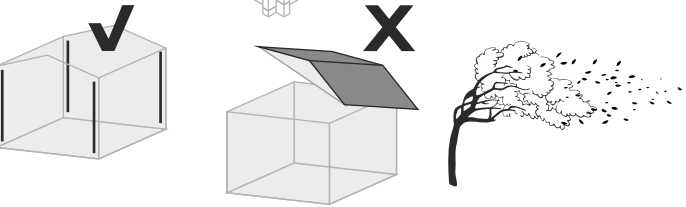

OPTIONS-STORM BRACES

5.

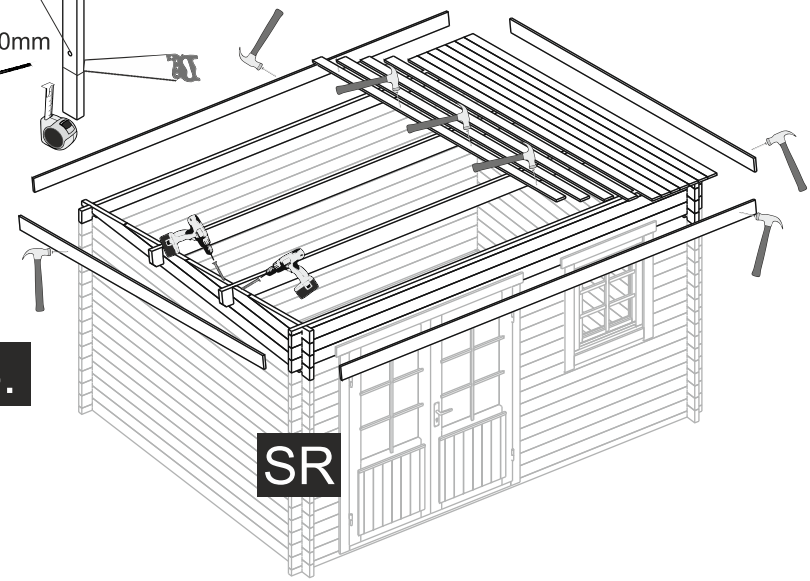

SR