

Assembly Instructions

Art.No. P 16-2225 Lekstuga Sonja

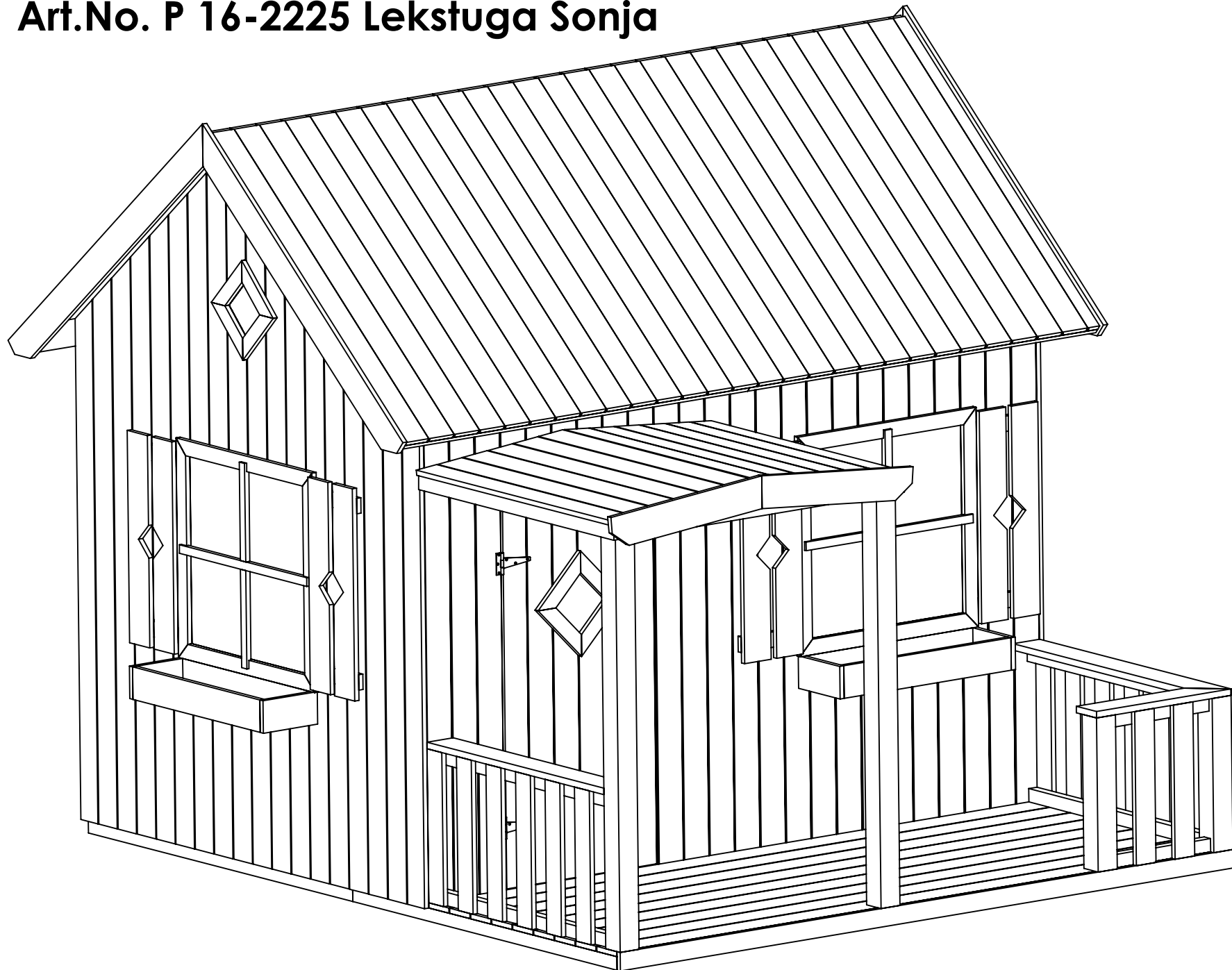

Inspection Certificate

Controlecertificaat • Kontrollschein • Bulletin de contrôle • Certificato di controllo • Certificado de control • Kontrollskjema • Kontrol Certifikat • Tarkastustodistus • Besiktningsprotokoll • Kontrolní certifikát • Pārbaudes akts • Apžiūros pažyma • Certyfikat kontrolny • Certificado de Inspeção

Please keep safely!

Zorgvuldig te bewaren! • Bitte gut aufbewahren! • A bien conserver, s.v.p.! • Da conservare! • ¡A conservar! • Ta vare på denne! • Opbevares sikkert! • Ole hyvä ja säilytä huolella! • Vänligen förvara säkert! • Prosím, pečlivě uschovejte! • Lūdzu, glabājiet drošā vietā! • Laikykite saugiai! • Przechowywać w bezpiecznym miejscu! • Por favor, guarde em segurança!

Art. Nr. P16-2225 Lekstuga Sonja

English: The house you have purchased was manufactured in accordance with the high quality norms. The building unit has been carefully inspected and packed. In order to avoid possible problems during the assembly carried out by yourself or the building company of your choice, we recommend that you inspect the delivery for its completeness in accordance with the list of pieces before assembly. This inspection must be carried out within 14 days after delivery to your place. Warranty claims are limited to the exchange of defective materials. Defective building parts, which have already been used or painted, are excluded from being replaced. All further claims are excluded! In cases of complaints, please pay attention to the following procedures: Please present this inspection certificate along with the sales receipt to your place of purchase. Only in cases where these documents are presented will the complaint be dealt with quickly and without complications.

Dutch: Het door U gekochte tuinhuis werd vervaardigd volgens de hoge kwaliteitsnormen. Het tuinhuis werd zorgvuldig gecontroleerd en verpakt. Om tijdens de montage, uitgevoerd door Uzelf of een door U gekozen aannemer, problemen te vermijden, raden we U aan, vóór de montage, de levering te controleren op volledigheid in overeenstemming met de onderdelenlijst. Deze controle dient te gebeuren binnen 14 dagen na levering bij U thuis. Waarborgvorderingen zijn beperkt tot het vervangen van gebrekkig materiaal. Gebrekkige onderdelen die reeds gebruikt of geschilderd zijn, zijn uitgesloten van vervanging. Alle latere vorderingen zijn uitgesloten! In geval van klachten, gelieve dan te letten op de volgende procedure: Leg dit controlecertificaat, samen met Uw aankoopbewijs voor aan Uw verkoper. Enkel in gevallen waarbij deze documenten voorgelegd worden, zal de klacht snel en zonder complicaties behandeld worden.

Deutsch: Das von Ihnen gekaufte Haus wurde nach der hohen Qualitätsnorm gefertigt. Der Bausatz wurde sorgfältig geprüft und verpackt. Um etwaige auftretende Probleme während des Aufbaus durch Sie oder Ihre Aufbaufirma zu vermeiden, kontrollieren Sie bitte die Lieferung auf Vollständigkeit laut Stückliste vor dem Aufbau. Diese Kontrolle muss innerhalb 14 Tagen nach Anlieferung bei Ihnen erfolgen. Ansprüche auf Gewährleistung beschränken sich auf den Austausch von fehlerhaftem Material. Fehlerhafte Bauteile, die bereits verbaut oder gestrichen wurden, sind vom Umtausch ausgeschlossen. Alle weiteren Ansprüche sind ausgeschlossen! Sollte es zu einer Beanstandung kommen, beachten Sie folgende Vorgehensweise: Legen Sie Ihrem Fachhändler diesen Kontrollschein zusammen mit dem Einkaufsbeleg vor. Nur bei Vorlage dieser Unterlagen ist eine schnelle und problemlose Bearbeitung Ihrer Beanstandung möglich.

Français: La cabane que vous venez d'acheter a été fabriquée en respectant de hautes normes de qualité. L'ensemble de construction a été testé et emballé avec soin. Afin d'éviter des problèmes éventuels pendant la construction par vous-même ou la société de construction mandatée, nous vous prions de bien vouloir vérifier que toutes les pièces ont été fournies selon la liste des pièces avant que vous ne commenciez la construction. Il vous incombe de faire ce contrôle dans les 14 jours après la fourniture. Les revendications en dédommagement se limitent à l'échange de matériel défectueux. Des pièces de construction défectueuses, déjà construites ou peintes, sont exclues de tout échange. Toutes les revendications ultérieures sont exclues ! Si une réclamation avait lieu, veuillez respecter le déroulement suivant : Il vous faudra présenter, à votre commerçant spécialisé, ce bulletin de contrôle avec le récépissé de l'achat. Ce ne sera que moyennant présentation de ces documents qu'un traitement rapide et sans problème de votre réclamation sera possible!

Italiano: La casetta che avete acquistato è stata prodotta secondo la norma di alta qualità. Il kit è stato controllato ed imballato con cura. Per evitare eventuali inconvenienti durante il montaggio, si prega di verificare, prima del montaggio, la completezza della fornitura in base alla distinta dei pezzi. Tale verifica deve essere effettuata entro 14 giorni dalla consegna. Eventuali diritti di garanzia si limitano alla sostituzione di materiale difettoso. Gli elementi difettosi già montati o verniciati sono esclusi dal diritto alla sostituzione. Ogni altro diritto resta escluso! In caso di reclamazione, procedere nel modo seguente: presentare questo certificato di controllo unitamente alla prova d'acquisto al rivenditore. Solo in questo modo la Sua reclamazione potrà essere evasa rapidamente e senza problemi.

Español: La casa que ha adquirido ha sido fabricada de acuerdo con normas de alta calidad. Las piezas de la casa han sido cuidadosamente inspeccionadas y embaladas. Con el fin de evitar posibles problemas durante el montaje, hecho por usted o por la empresa de construcción de su elección, le recomendamos revisar el paquete entregado, con la lista de piezas, antes de armar la casa. Haga la revisión dentro de 14 días después de recibir el paquete. La garantía se limita a reemplazar las piezas defectuosas. No se reemplazarán las partes defectuosas que ya hayan sido utilizadas o pintadas. ¡No se aceptan otras reclamaciones! En casos de queja, por favor, presente este certificado junto con la factura en el lugar donde hizo la compra. Sólo presentando estos documentos podremos resolver su problema rápidamente y sin complicaciones.

Norsk: Produktet du har kjøpt, ble produsert i henhold til høye kvalitetskrav. Produktet har blitt kontrollert nøye og deretter omhyggelig pakket. For å unngå mulige problemer under monteringen, uansett om du gjør det selv eller får en godkjent håndverker til å gjøre det, anbefaler vi at du kontrollerer leveransen mot delelisten for å se om alle delene er inkludert. Denne kontrollen må gjøres innen 14 dager etter at delene ble levert til din adresse. Garantikrav begrenser seg til bytte av defekte deler. Defekte elementer som allerede har blitt brukt eller malt/beiset/limt, vil ikke bli erstattet. Alle andre krav er utelukket! Dersom du har en reklamasjon, vennligst gjør som følger: Lever dette kontrollskjema med kvitteringen til salgsstedet. Bare når du har med disse dokumentene kan klagen behandles raskt og uten komplikasjoner.

Dansk: Det købte hus er fremstillet i overensstemmelse med de høje kvalitetskrav. Produktet er blevet omhyggeligt inspiceret og pakket. For at undgå eventuelle problemer i løbet af monteringen udført af dig selv eller håndværker af dit eget valg, anbefaler vi, at du undersøger leverancen for fuldstændighed i overensstemmelse med listen over dele før samling. Denne inspektion skal foretages inden 14 dage efter levering til din plads. Garantikrav er begrænset til udveksling af defekte materialer. Defekte bygningsdele, som allerede er brugt eller malet, er udelukket fra at blive erstattet. Alle yderligere krav er udelukket! I tilfælde af klager, skal du være opmærksom på følgende procedurer: Venligst præsenter denne kontrol certifikat sammen med kvitteringen til det sted hvor produktet er købt. Kun i de tilfælde, hvor disse dokumenter er forelagt kan klagen behandles hurtigt og uden komplikationer.

Suomi: Ostamasi mökki on valmistettu korkeita laatuvaatimuksia noudattaen. Rakennus on huolella tarkastettu ja pakattu. Jotta pystytys joko itsesi tai valitsemasi rakennusliikkeen toimesta sujuisi ongelmitta, suosittelimme, että tarkistat toimituksen sisällön osaluettelon avulla ennen kokoamisen aloittamista. Tämä tarkistus tulee tehdä 14 päivän kuluessa toimituksesta. Takuuvaateet rajoittuvat viallisten materiaalien vaihtamiseen. Viallisia osia, joita on jo käytetty ja jotka on maalattu, ei vaihdeta uusiin. Lisävaatimuksia ei huomioida! Mahdollisissa valitustapauksissa toimi seuraavasti: Esitä ohainen tarkastustodistus ja kassakuitti ostopaikassa. Valituksen nopea ja mutkaton käsittely edellyttää näiden asiakirjojen esittämistä.

Svenska: Huset du köpt har tillverkats i enlighet med de högsta kvalitetsstandarderna. Byggnadens delar har noggrant besiktigats och förpackats. För att undvika eventuella problem under monteringen som du utför själv eller låter en hantverkare att utföra, rekommenderar vi att du, innan monteringen påbörjas, besiktigar leveransen för att säkerställa att den är komplett enligt förteckningen över ingående delar. Denna besiktning måste utföras inom 14 dagar efter att du tagit emot leveransen. Garantianspråk är begränsade till ersättning av defekt material. Defekta byggnadsdelar, vilka redan har använts eller målats, ersätts inte. Alla vidare anspråk avvisas! I händelse av reklamationer, vänligen uppmärksamma följande: uppvisa detta besiktningssprotokoll tillsammans med inköpsbeviset till ditt inköpsställe. Endast om dessa dokument uppvisas kan vi garantera att reklamationen behandlas skyndsamt och utan krångel.

Čeština: Dům, který jste zakoupil, byl vyroben v souladu s normami stanovujícími vysokou kvalitu. Stavební jednotka byla výrobcem pečlivě prohlédnuta a zabalena. Aby se předešlo možným problémům při montáži prováděné svépomocí nebo stavební firmou dle vašeho výběru, doporučujeme vám před montáží zkontrolovat dodávku na úplnost v souladu se seznamem dílů. Tato prohlídka musí být provedena do 14 dnů (!) od doručení do místa určení. Záruční nároky jsou omezeny na výměnu vadných materiálů. Vadné stavební díly, které již byly použity nebo které jsou již opatřeny nátěrem, nemohou být nahrazeny. Všechny další nároky jsou vyloučeny! V případě reklamace věnujte prosím pozornost tomuto postupu: Předložte svému prodejci tento kontrolní certifikát spolu s prodejním dokladem. Pouze v případě, kdy jsou předloženy oba tyto dokumenty, lze reklamaci řešit rychle a bez komplikací.

Latviešu: Mājīņa, kuru esat iegādājies, ir ražota saskaņā ar augstām kvalitātes normām. Šī celtniecības vienība ir rūpīgi pārbaudīta un iepakota. Lai izvairītos no iespējamām sarežģījumiem montāžas laikā, kuru veicat jūs pats vai jūsu izvēlēts celtniecības uzņēmums, pirms montāžas iesakām pārbaudīt, vai piegādātajam izstrādājumam nekas netrūkst, izmantojot detaļu sarakstu. Šī pārbaude jāveic 14 dienu laikā pēc piegādāšanas. Garantija paredz tikai defektīvo materiālu apmaiņu. Defektīvas detaļas, kuras jau ir izmantotas vai nokrāsotas, netiks mainītas. Visas turpmākās prasības tiks noraidītas! Sūdzību gadījumā, lūdzu, ievērojiet šādu kārtību: lūdzu, uzrādiet šo pārbaudes aktu kopā ar pirkuma čeku izstrādājuma iegādāšanās vietā. Sūdzība tiks atrisināta ātri un bez sarežģījumiem tikai tad, ja tiks uzrādīti šie dokumenti.

Lietuviškai: Namelis, kurį įsigijote, pagamintas pagal aukštos kokybės standartus. Blokas, kurį reikia surinkti, buvo atidžiai patikrintas ir supakuotas. Siekiant išvengti galimų problemų surenkant namelį patiems arba pasirinkus tam norimą statybos bendrovę, prieš surenkant rekomenduojame patikrinti pristatymo komplektaciją pagal dalių sąrašą. Ši patikra turi būti atlikta per 14 dienų nuo pristatymo į jūsų nurodytą vietą. Garantinės sąlygos taikomos tik brokuotoms dalims. Brokuotos statybinės dalys, kurios buvo panaudotos arba nudažytos, nebekeičiamos. Visos kitos pretenzijos nesvarstomos! Jei teikiate pretenziją, atkreipkite dėmesį į šias procedūras: į produkto įsigijimo vietą turite pristatyti apžiūros pažymėjimą bei pirkimo kvitą. Tik tais atvejais, kai pristatomi minėti dokumentai, pretenzija gali būti nagrinėjama greitai ir be komplikacijų.

Polski: Dom, który Państwo zakupili wykonano według najwyższych norm jakości. Elementy konstrukcyjne przed zapakowaniem przeszły dokładną kontrolę jakości. Aby uniknąć problemów podczas samodzielnego montażu, bądź montażu zleconego firmie budowlanej, przed montażem zalecamy sprawdzenie zawartości przesyłki zgodnie z listą części zamieszczonych w zestawie. Kontrolę kompletności zestawu należy dokonać w ciągu 14 dni od dostarczenia przesyłki. Reklamacje objęte gwarancją ograniczają się do wymiany wadliwych elementów. Wadliwe elementy, które zostały użyte lub pomalowane nie będą podlegały wymianie ani dalszym reklamacjom. W przypadku potrzeby zgłoszenia reklamacji, prosimy przestrzegać poniższych procedur: prosimy przedłożyć kontrolny wraz z paragonem zakupu i adresem dostawy. Reklamacje będą rozpatrywane wyłącznie po dostarczeniu powyższych dokumentów.

Portuguesa: A casa que comprou foi fabricada em conformidade com as normas de alta qualidade. A unidade de construção foi cuidadosamente inspecionada e embalada. Para evitar possíveis problemas durante a montagem realizada por si ou pela empresa de construção à sua escolha, recomendamos que inspecione a entrega na íntegra, em conformidade com a lista de peças antes da montagem. Esta inspeção deve ser realizada no prazo de 14 dias após a entrega. As reclamações de garantia limitam-se à troca de materiais defeituosos. As peças de construção com defeito, que já tenham sido utilizadas ou pintadas, excluem-se da substituição. Excluem-se todas as outras reclamações! Em caso de reclamações, por favor, tome atenção aos seguintes procedimentos: Por favor, apresente este certificado de inspeção, juntamente com o recibo de venda no seu local de compra. Apenas nos casos em que estes documentos sejam apresentados a queixa será tratada com rapidez e sem complicações.

Factory inspection by • Fabriekscontrole door • Werkskontrolle durch • Contrôle à partir de l'usine par • Collaudato da • Inspector de fábrica • Fabrikkontroll utført av • Fabriks Kontroll utført af • Tehtaan tarkastaja • Fabriksbesiktigat av • Zkontrolováno ve výrobním závodě • Rūpnīcas pārbaudi veicis • Apžiūrą gamykloje atliko • Kontrola fabryczna do • Inspeção de fábrica, por:

Pack number • Pack Nr. • Pack Nr. • Packet n° • Pacco N. • Paquete No • Serien • Pakettinro • Produktionsnummer • Číslo paketu • Iepakojuma numurs • Pakuotės numeris • Nnumer opakowania • Número de embalagem:

Date • Datum • Date • Data • Fecha • Dato • Päiväys • Datum • Datums:

To be completed by buyer! (Please use block letters) • In te vullen door de verkoper! (Graag in drukletters) • Vom Käufer auszufüllen! (Bitte in Druckschrift) • A remplir par l'acheteur! (en lettres d'imprimerie, s'il vous plaît) • Da compilare dall'acquirente! (in stampatello) • ¡Completar el cliente! (en mayúsculas) • Fylles ut av kjøper! (Vær vennlig å bruke blokkbokstaver) • Udfyldes af køber! (Benyt venligst Blokbogstaver) • Ostaja täyttää! (Ole hyvä ja käytä isoja kirjaimia) • Fylls i av köparen! (Vänligen texta) • Vyplní kupující! (Prosíme hůlkovým písmem) • Aizpilda pircējs! (Lūdzu, izmantojiet drukātos burtus.) • Pildo pirkējas (didžiosiomis raidėmis)! • Wypełnia nabywca (drukowanymi literami) • A completar pelo fabricante! (por favor escreva em letra de máquina):

Place of purchase • Plaats van aankoop • Bezugsquelle • Source d'achat • Acquistato presso • Lugar de compra • Salgssted • Salgs sted • Ostopaikka • Inköpsställe • Místo nákupu • Iegādāšanās vieta • Isgijimo data • Miejsce zakupu • Local de compra:

Sales receipt No. • Aankoopbewijs Nr. • Kaufbeleg-Nr. • Récépissé n° • Prova d'acquisto N. • Recibo No • Kvitteringsnr • Kasse Bon nr • Kassakuitin numero • Försäljningskvittots nummer • Prodejní doklad č. • Pirkuma čeka Nr. • Pardavimo kvito Nr. • Nr paragonu • Recibo de venda n.º:

Sales receipt date • Aankoopbewijs -Datum • Kaufbeleg-Datum • Date du récépissé • Data prova d'acquisto • Fecha recibo • Kvitteringsdato • Kasse bons dato • Kassakuitin päiväys • Försäljningskvittots datum • Datum prodejního dokladu • Pirkuma čeka datums • Pirkimo kvito data • Data paragonu • Data do recibo de venda:

Delivery date • Leveringsdatum • Lieferdatum • Date de livraison • Data di consegna • Fecha de Entrega • Leveringsdato • Leverings dato • Toimituspäivä • Leveransdatum • Termín dodání • Piegādes datums • Pristatymo data • Data dostawy • Data de entrega:

Buyer's address • Adres koper • Kundenanschrift • Adresse du client • Indirizzo del cliente • Dirección del cliente • Kjøpers adresse • Købers adresse • Ostajan osoite • Köparens adress • Adresa kupujícího • Pircēja adrese • Pircēja adrese • Pirkėjo adresas • Adres nabywcy • Morada do comprador:

Telephone • Telefoon • Telefon • Téléphone • Teléfono • Telefon • Telefon nr • Puhelin • Telefon • Telefon • Tālrunis • Telefonas • Telefon • Telefone:

Forwarder: Pick-up Others • Door: Verzending Zelf • Afhalen: Spedition Selbstabholer • Par: Transporteur Propres moyens • Tramite: Spedizioniere Mezzo proprio • Entrega: Transporte organizado transporte propio • Transportør: Sendes Hentes • Transportør: Sendes Hentes • Rahdinkuljettaja: Nouto Muut • Speditör: Avhämtning Övrigt • Zasilatel: Sběrná služba Ostatní • Ekspeditors: Saņemšana uz vietas Cits • Ekspeditorius: „Pick-up“ Kita • Przekazywanie: odbiór w sklepie Inne • Remetente: Entrega Outros

Description of complaint • Beschrijving van de klacht • Schilderung der Beanstandung • Description de la réclamation • Descrizione della reclamazione • Descripción del problema • Beskrivelse av feil/ mangel • Beskrivelse af fejl / Mangel • Valituksen kuvaus • Beskrivning av reklamationen • Popis reklamace • Sūdzības apraksts • Skundo aprašymas • Opis reklamacji • Descrição da reclamação: Please keep the parts which are the object of the complaint until the complaint is settled! • Gelieve de betrokken onderdelen te bewaren tot de klacht is afgehandeld • Veuillez garder les pièces contestées jusqu'à ce que la réclamation soit traitée définitivement! • Si prega di conservare i pezzi reclamati fino all'evasione della reclamazione! • Por favor, conserve las piezas objeto de la queja hasta que el problema haya sido resuelto • Please Vær vennlig å ta vare på de aktuelle delene/ produktet inntil saken er avsluttet! • Venligst ta hånd om de aktuelle dele / produkt inntil sagen er avsluttet! • Ole hyvä ja säilytä osat, joita valitus koskee, kunnes valitus on käsitelty! • Vänligen behåll delarna som är föremål för reklamation tills reklamationen har behandlats! • Uchovajte prosím díly, které jsou předmětem stížnosti, dokud reklamace nebude vyřízena! • Lūdzu, saglabājiēt detaļas, uz kurām sūdzība attiecas, līdz sūdzība tiek atrisināta! • Dalis, kurios yra skundo objektas, reikia išsaugoti tol, kol skundas bus išnagrinėtas! • Prosimy zachować części będące przedmiotem reklamacji do czasu jej rozpatrzenia. • Por favor, guarde as peças objeto da reclamação, até que a reclamação esteja resolvida!

Foundation plan

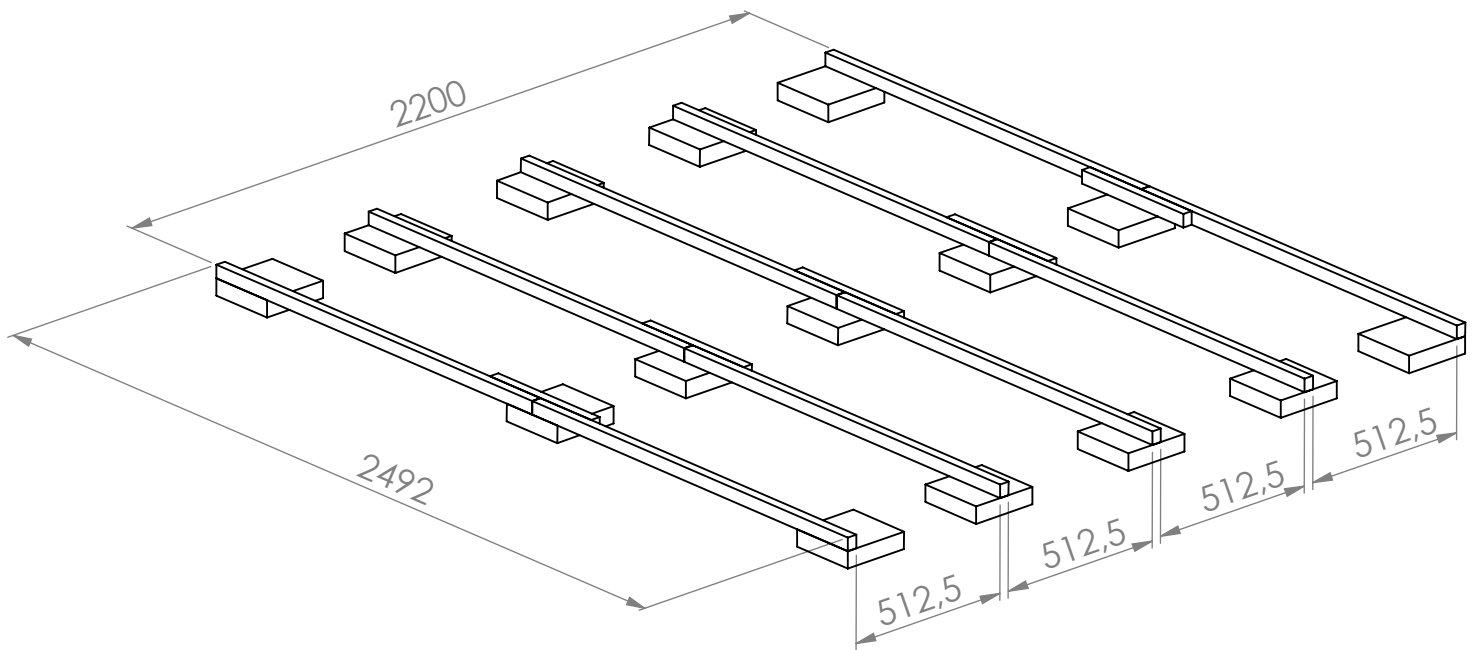

Plintar är ej inkluderade i byggsatsen



Grunnster er ikke inkludert i byggesettet





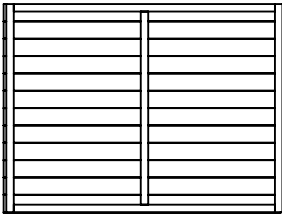
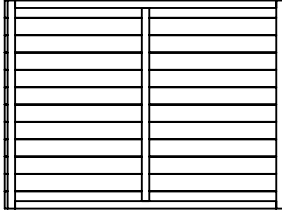
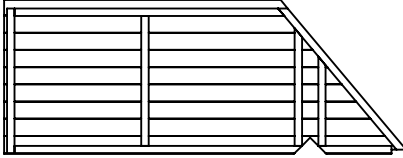
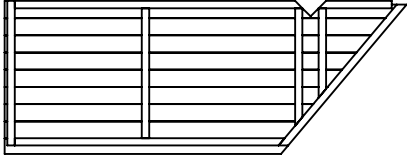
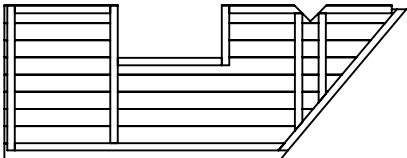
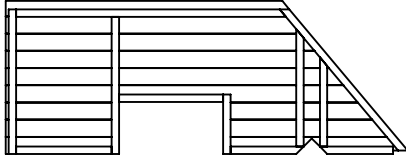
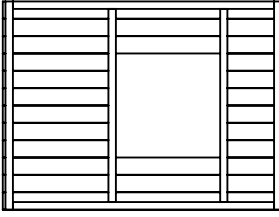
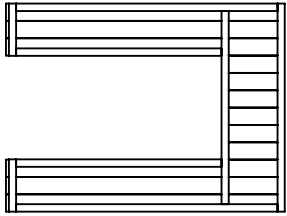

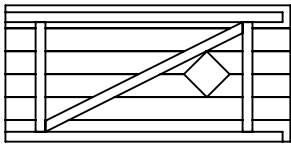
Grundsten er ikke inkluderet i byggesættet

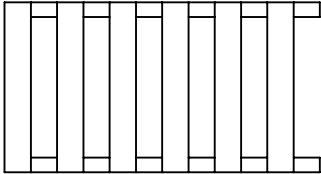
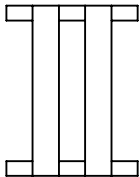
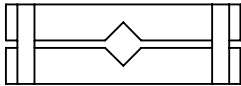
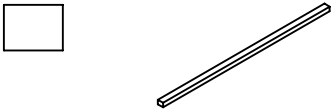
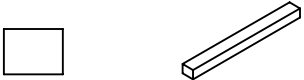
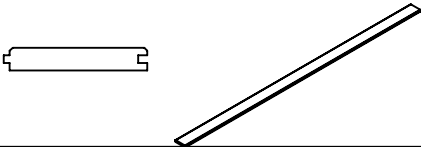
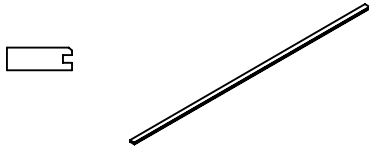
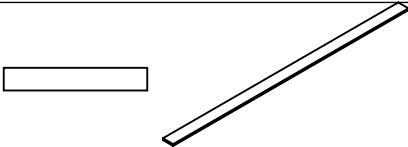
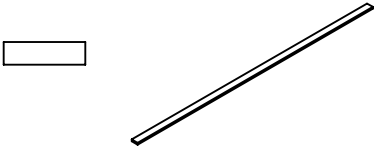

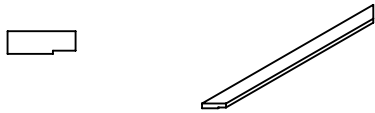

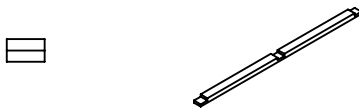
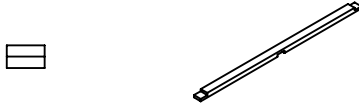

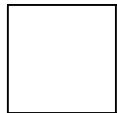
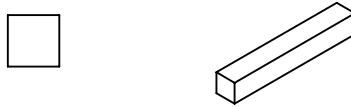
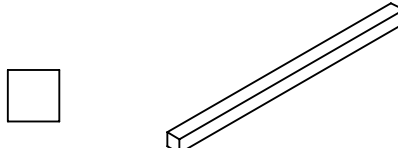
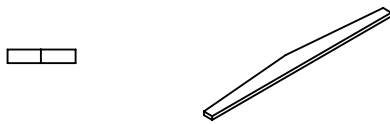
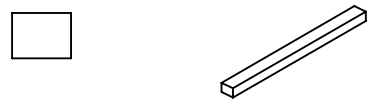
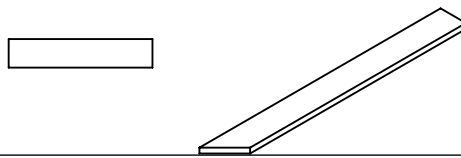
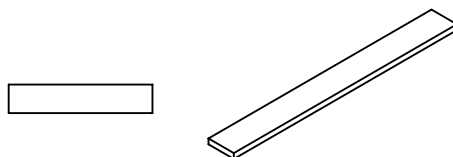
Foundation stones are not included in the building kit

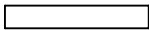
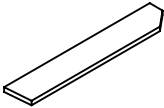

Perustuksen kivet eivät kuulu rakennussarjan toimitukseen

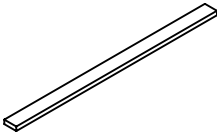
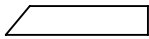
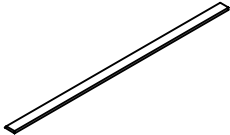
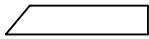
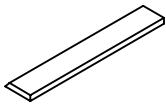
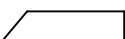
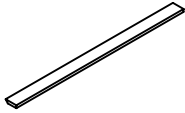
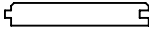
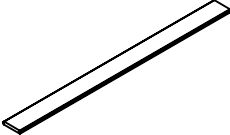
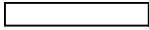
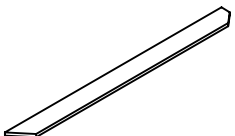
<p>EL 1</p>		<p>1105x1475x46</p>	<p>1</p>
<p>EL 2</p>		<p>1100x1475x46</p>	<p>1</p>
<p>EL 3</p>		<p>815x2130x46</p>	<p>1</p>
<p>EL 4</p>		<p>810x2130x46</p>	<p>1</p>
<p>EL 5</p>		<p>810x2130x46</p>	<p>1</p>
<p>EL 6</p>		<p>815x2130x46</p>	<p>1</p>
<p>EL 7</p>		<p>1100x1475x46</p>	<p>1</p>
<p>EL 8</p>		<p>1105x1475x46</p>	<p>1</p>

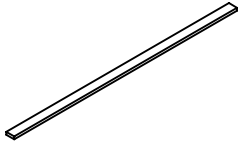
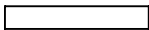
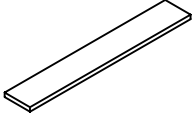
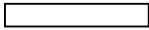
EL 9		544x1130x46	1
EL 10		530x920x30	2
EL 11		450x834x44	2
EL 12		450x346x44	1
EL 13		210x620x30	4
1.1		30x39x1246	10
1.2		30x39x400	5
2.1		15x95x2200	17
2.2		15x43x2200	1
2.3		15x95x2200	9
2.4		15x54x2200	1

3.1		15x45x641	8
3.2		15x45x218	12
3.3		18x25x600	2
3.4		18x25x600	2
3.5		580x580x1,5	2
3.6		154x154x1,5	3
4.1		68x68x450	2
4.2		68x68x1260	2
4.3		15x95x1005	1
4.4		30x39x500	2
5.1		15x95x905	1
5.2		15x95x834	1
5.3		15x95x482	1

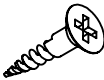
6.1	 	15x95x545	2
6.2	 	15x45x920	2
7.1	 	19x95x1900	2
7.2	 	19x95x600	2
7.3	 	15x80x1250	4
8	 	15x95x1180	56
9.1	 	15x95x1210	4
9.2	 	15x45x1250	4
10.1	 	15x95x600	6
10.2	 	15x95x150	4

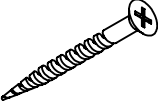
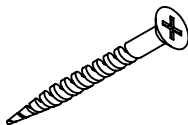
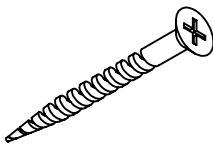
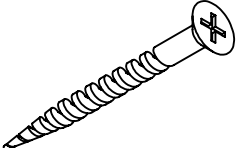
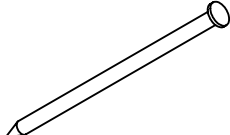
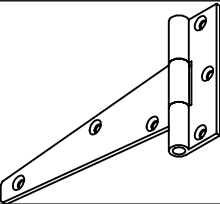
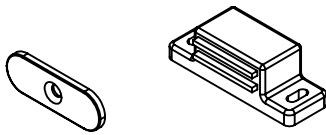
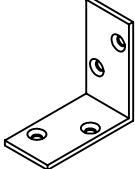
3x15		3
3,5x25		56
3,5x30		60
3,5x35		144
3,5x40		4
4,0x50		24
4,0x60		71
2x40		504
T-hinge		2
Magnet		1
Metal bracket		12

Recommended tools for assembly

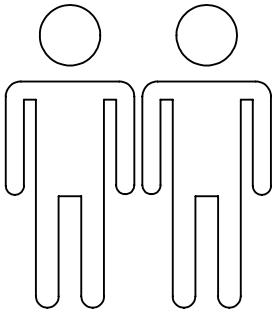

3mm

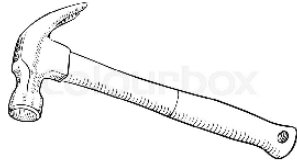

NB! Drill the pilot holes for the screws

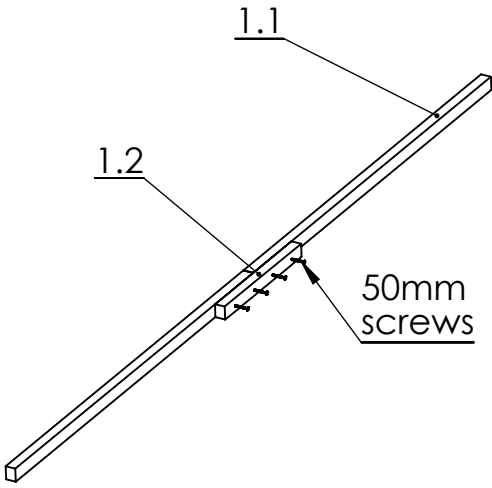

1.1	10 pcs
1.2	5 pcs
50mm screw	20 pcs

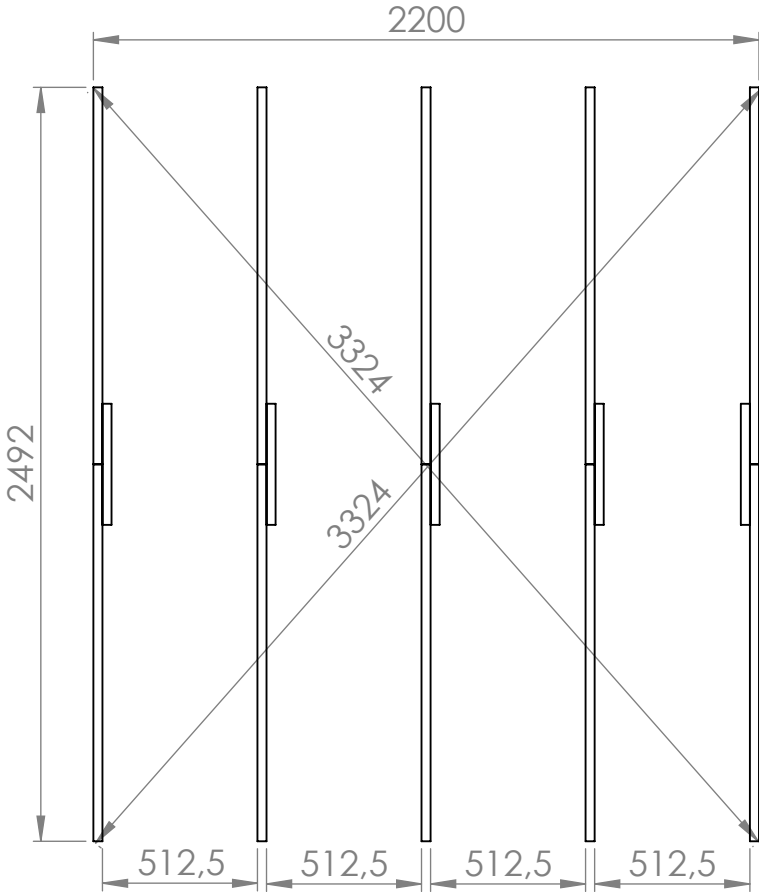
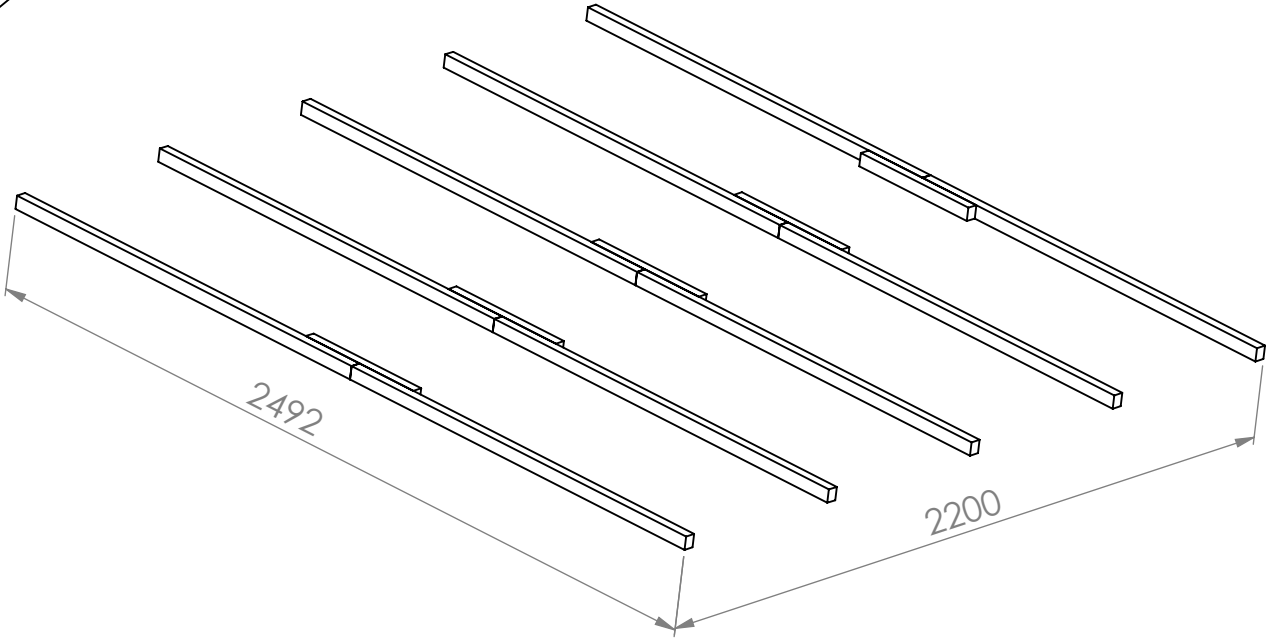

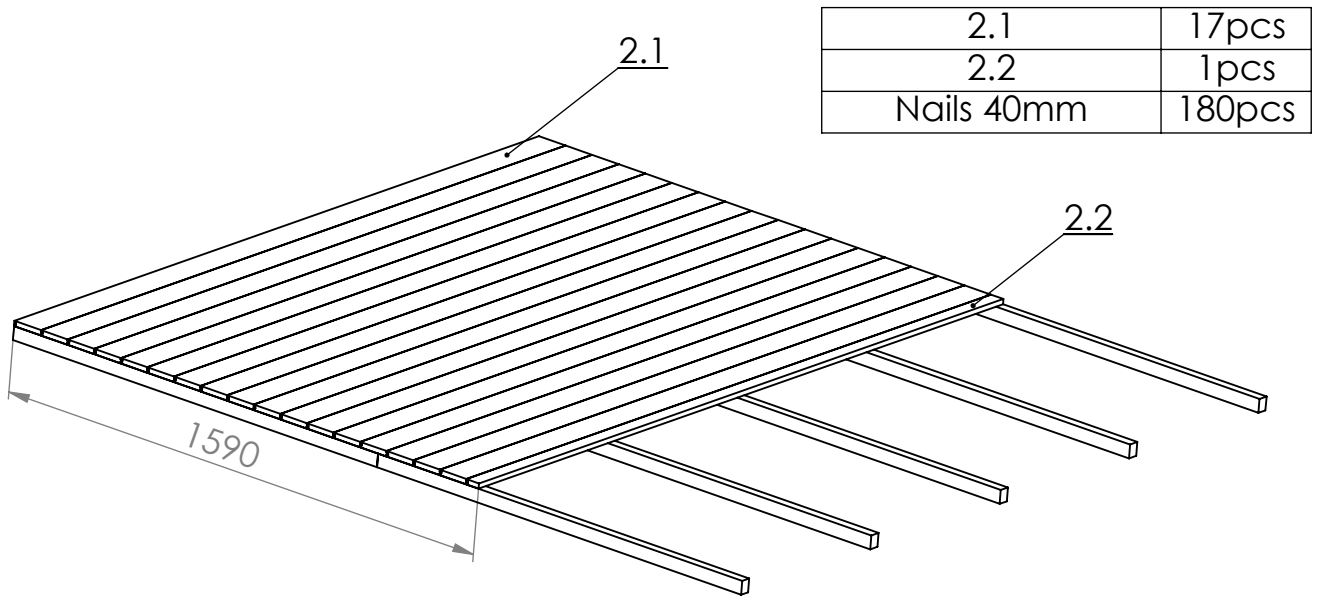

NB! Drill the pilot holes for the screws

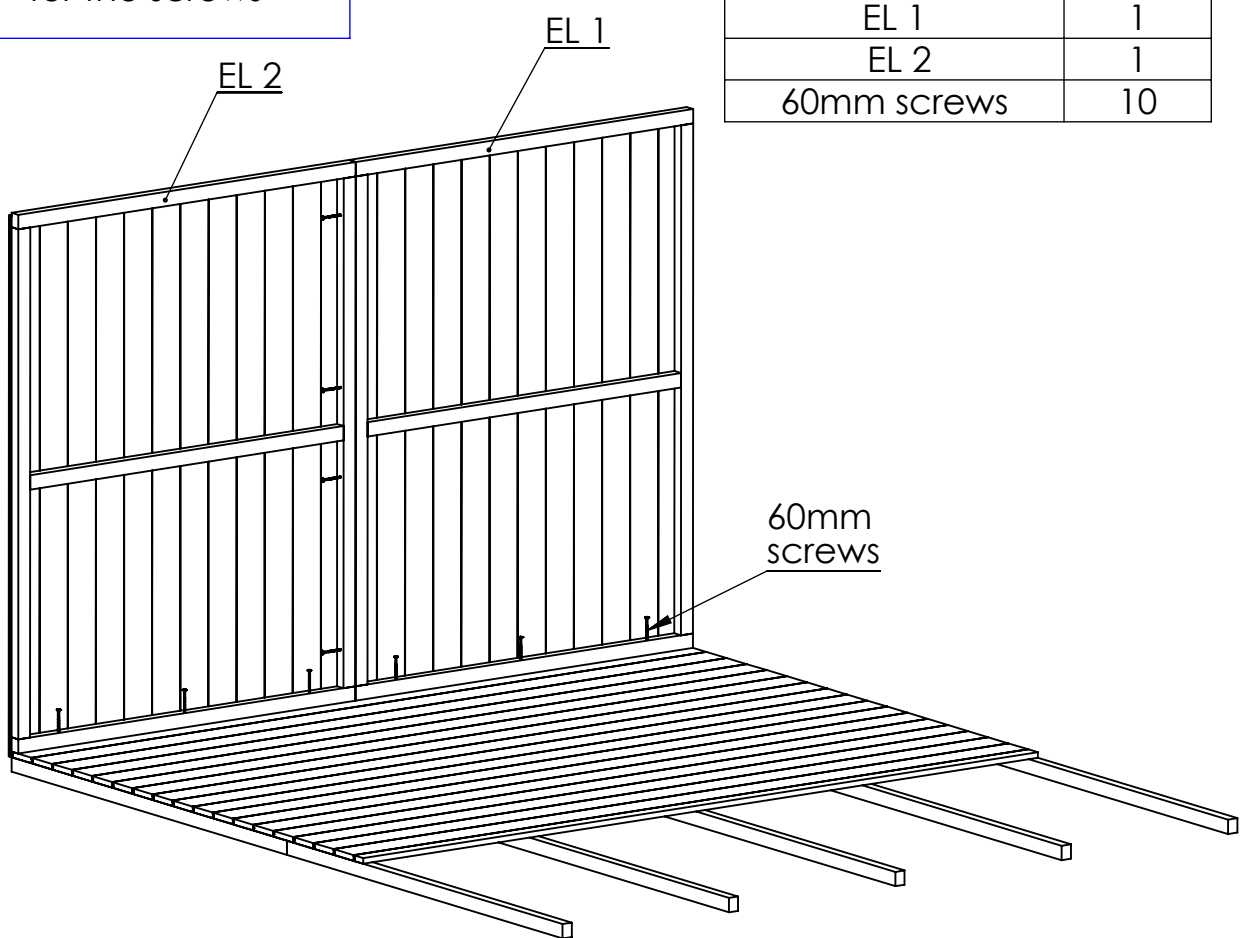

NB! Drill the pilot holes for the screws

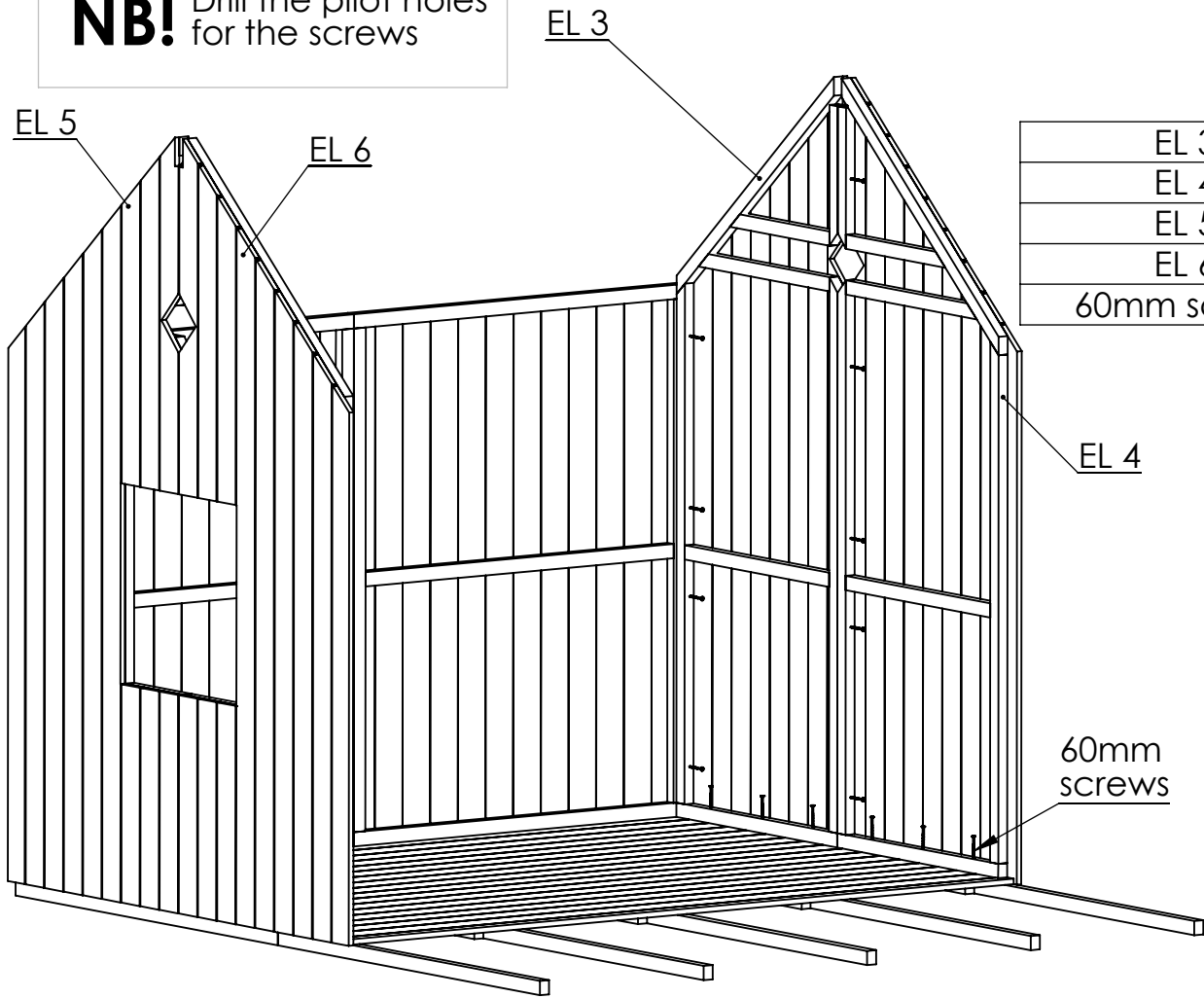

EL 3	1
EL 4	1
EL 5	1
EL 6	1
60mm screws	30

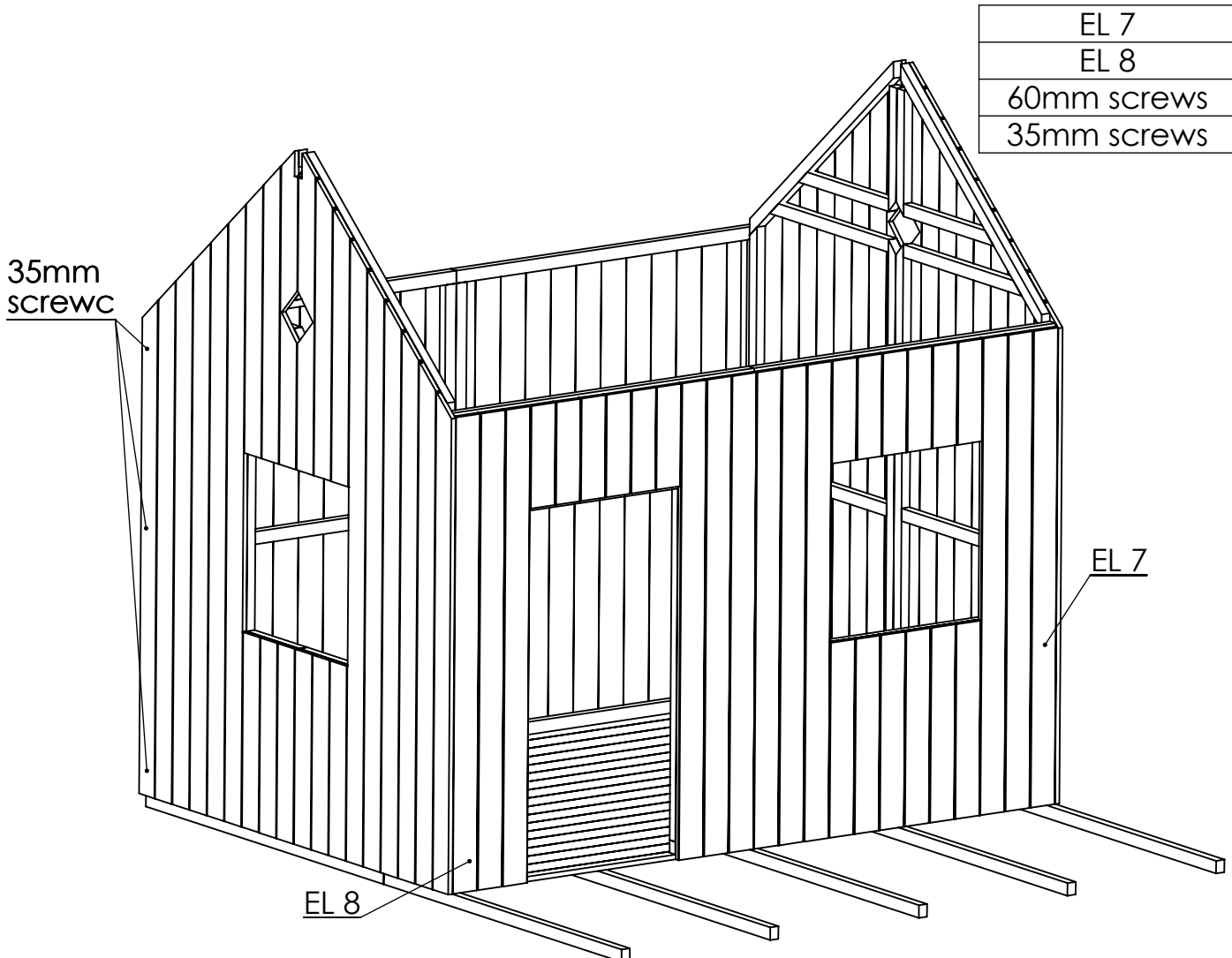

EL 7	1
EL 8	1
60mm screws	17
35mm screws	12

NB! Drill the pilot holes for the screws

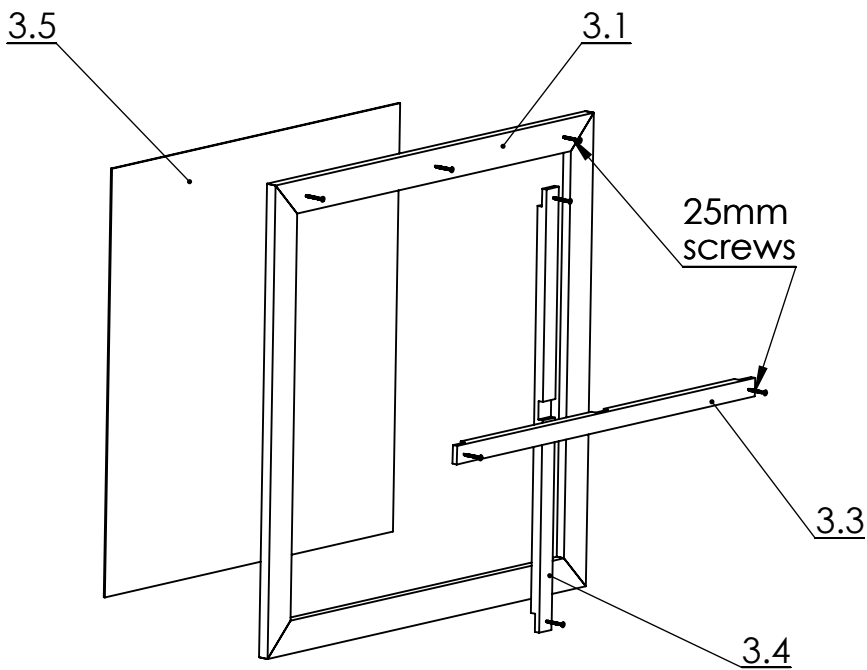
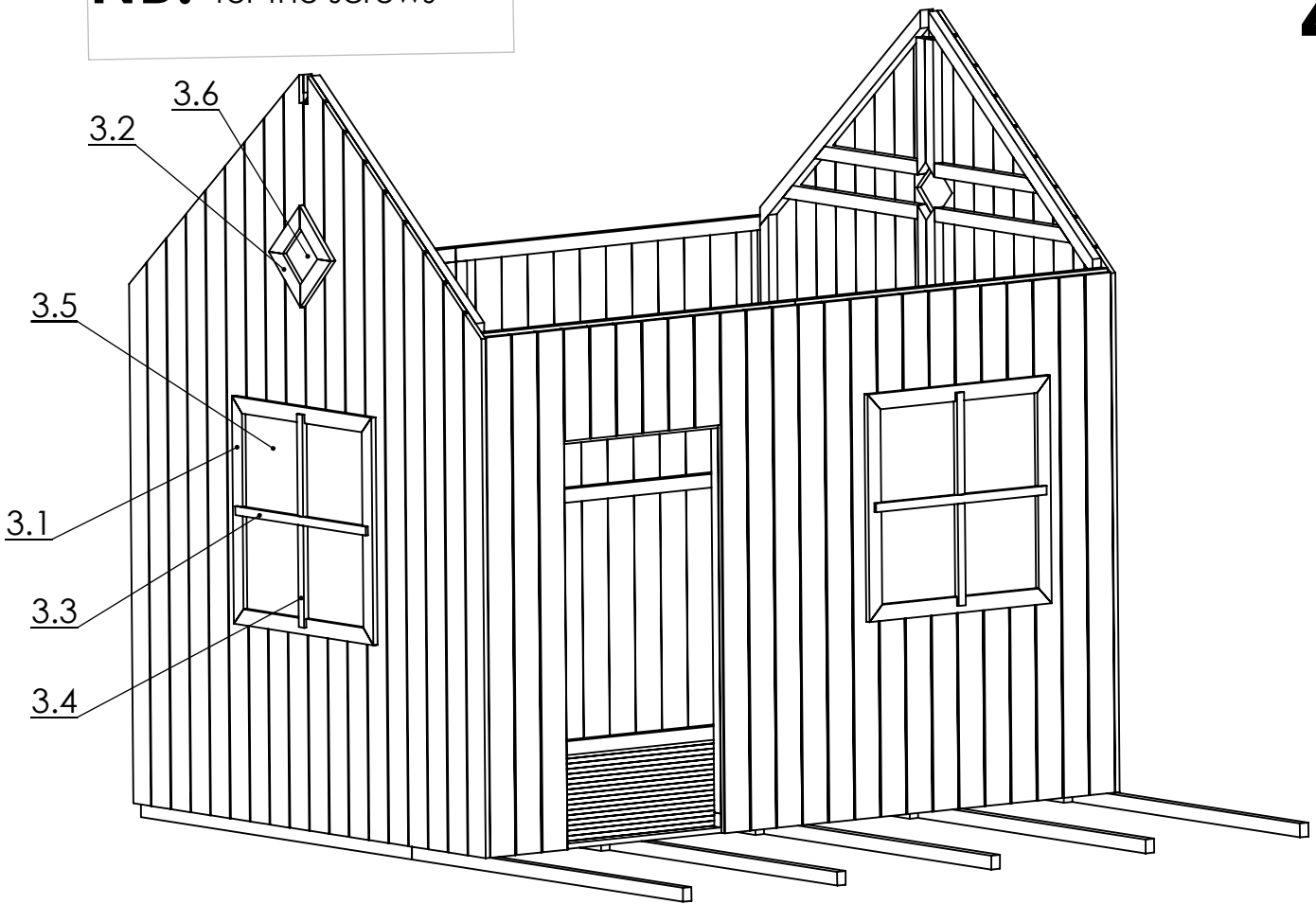

3.1	8
3.2	8
3.3	2
3.4	2
3.5	2
3.6	2
25mm screws	48

NB! Drill the pilot holes for the screws

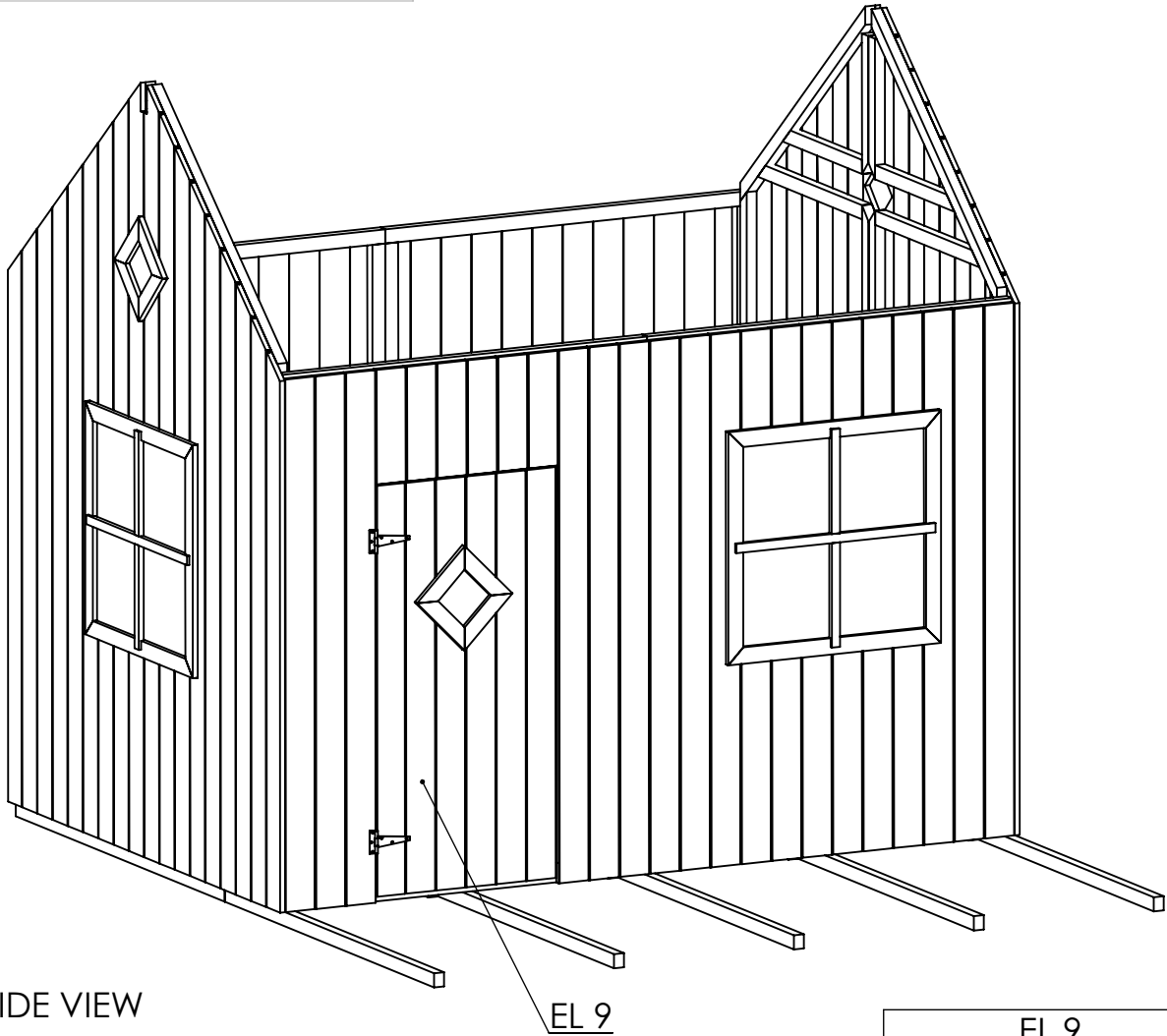

INSIDE VIEW

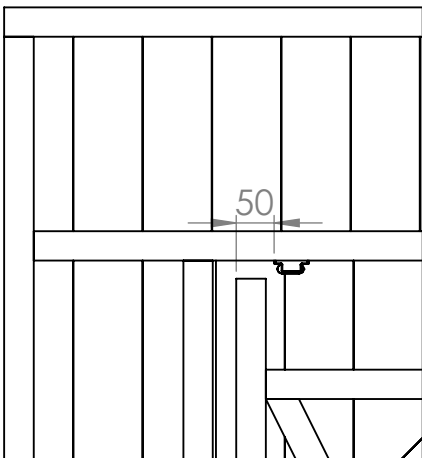
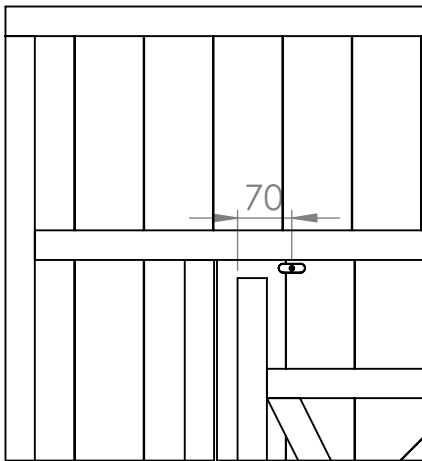

EL 9	1
T-hinge	2
35mm screws	14
3.2	4
3.6	1
25mm screws	8
Magnet	1
15mm screws	3

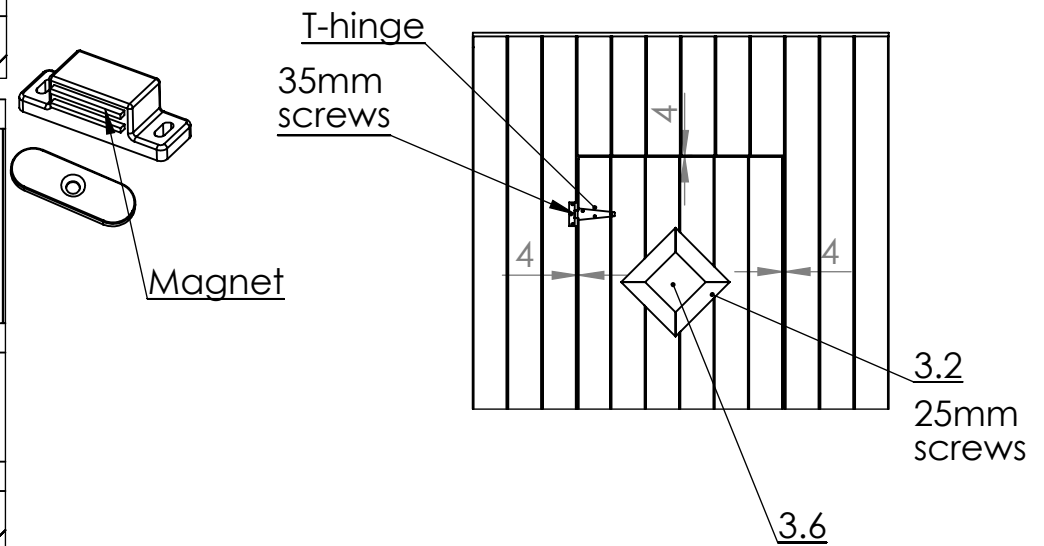

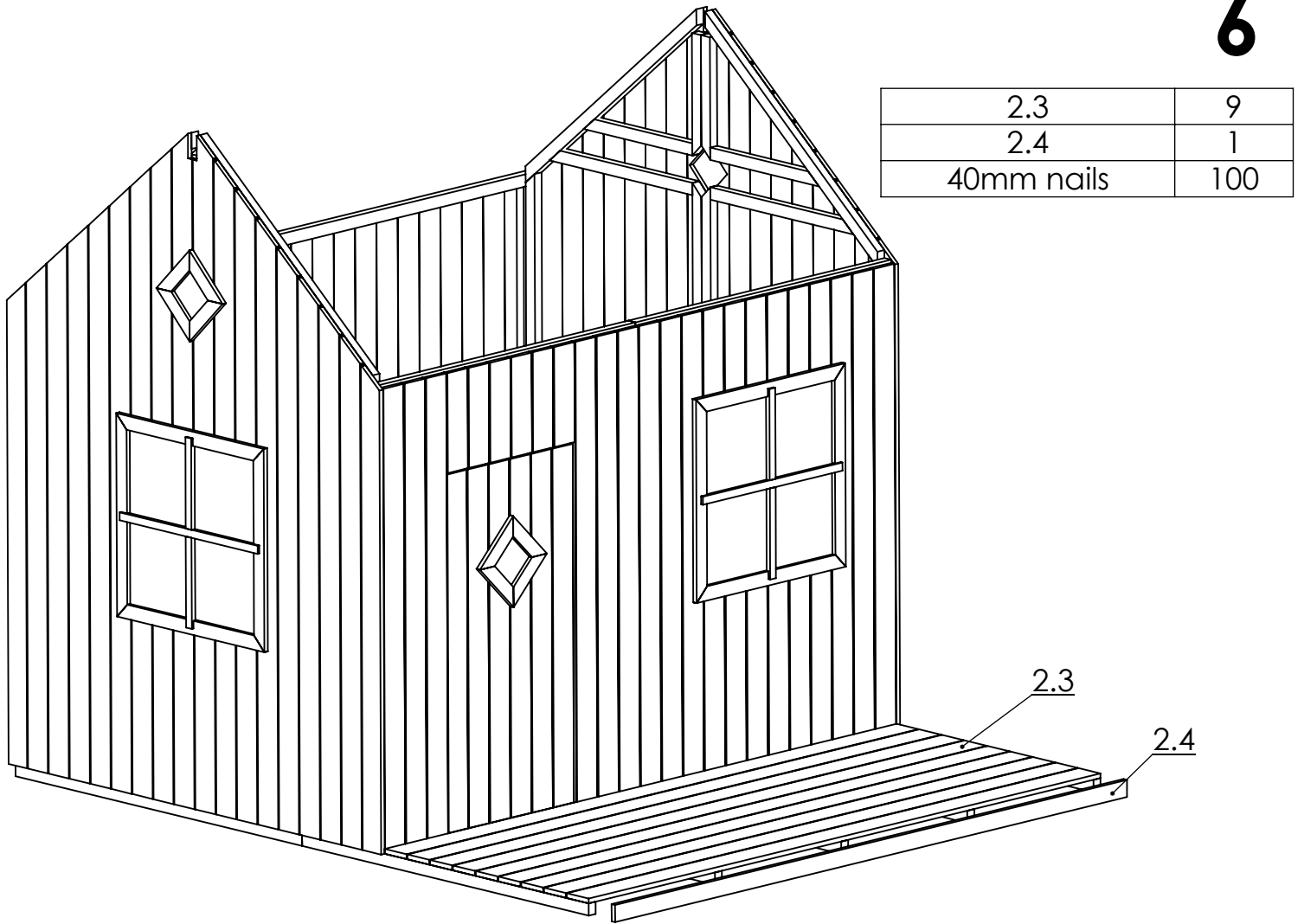

2.3	9
2.4	1
40mm nails	100

NB! Drill the pilot holes for the screws

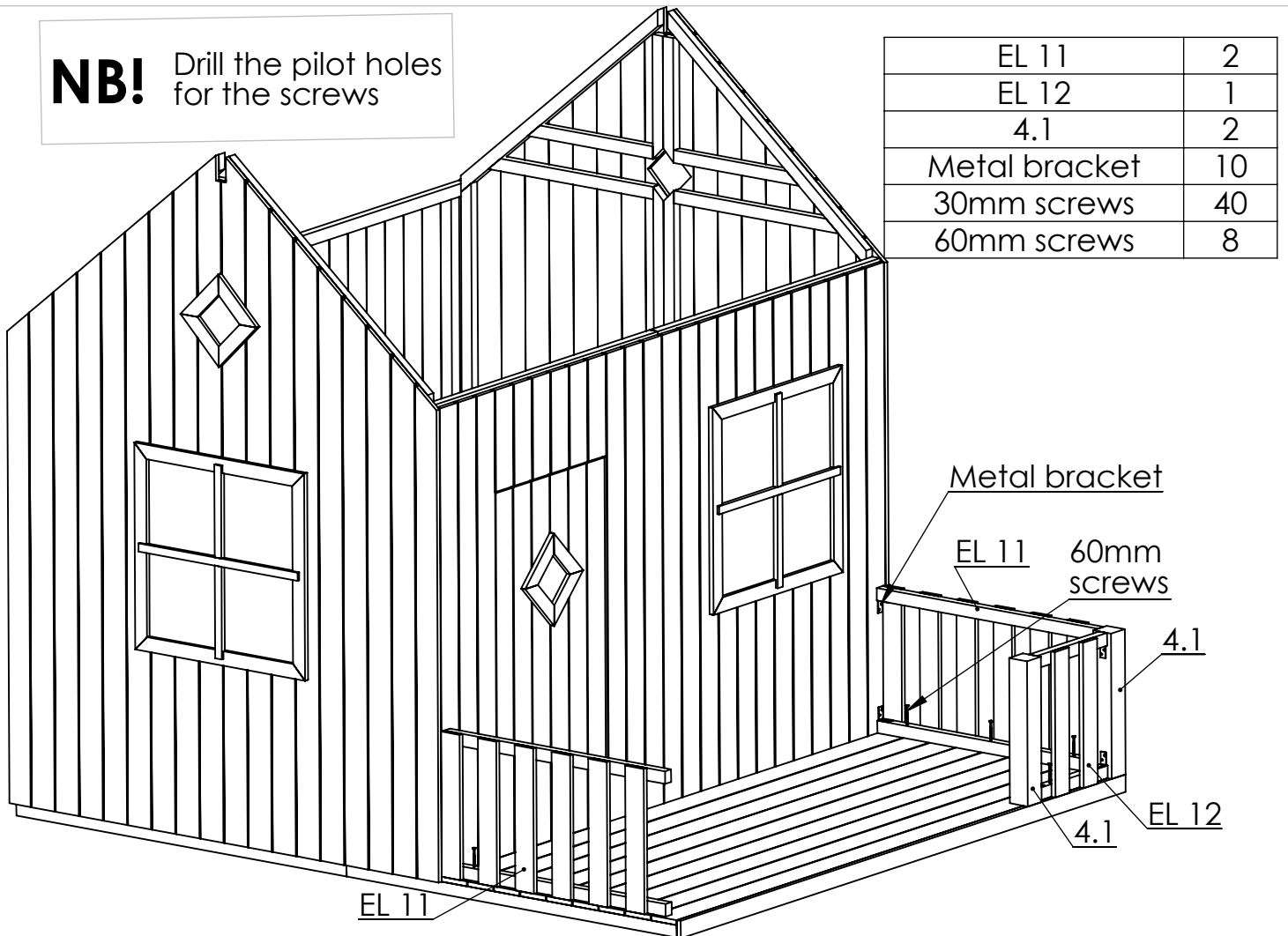

EL 11	2
EL 12	1
4.1	2
Metal bracket	10
30mm screws	40
60mm screws	8

Metal bracket

EL 11

60mm screws

4.1

4.1

EL 12

EL 11

NB! Drill the pilot holes for the screws

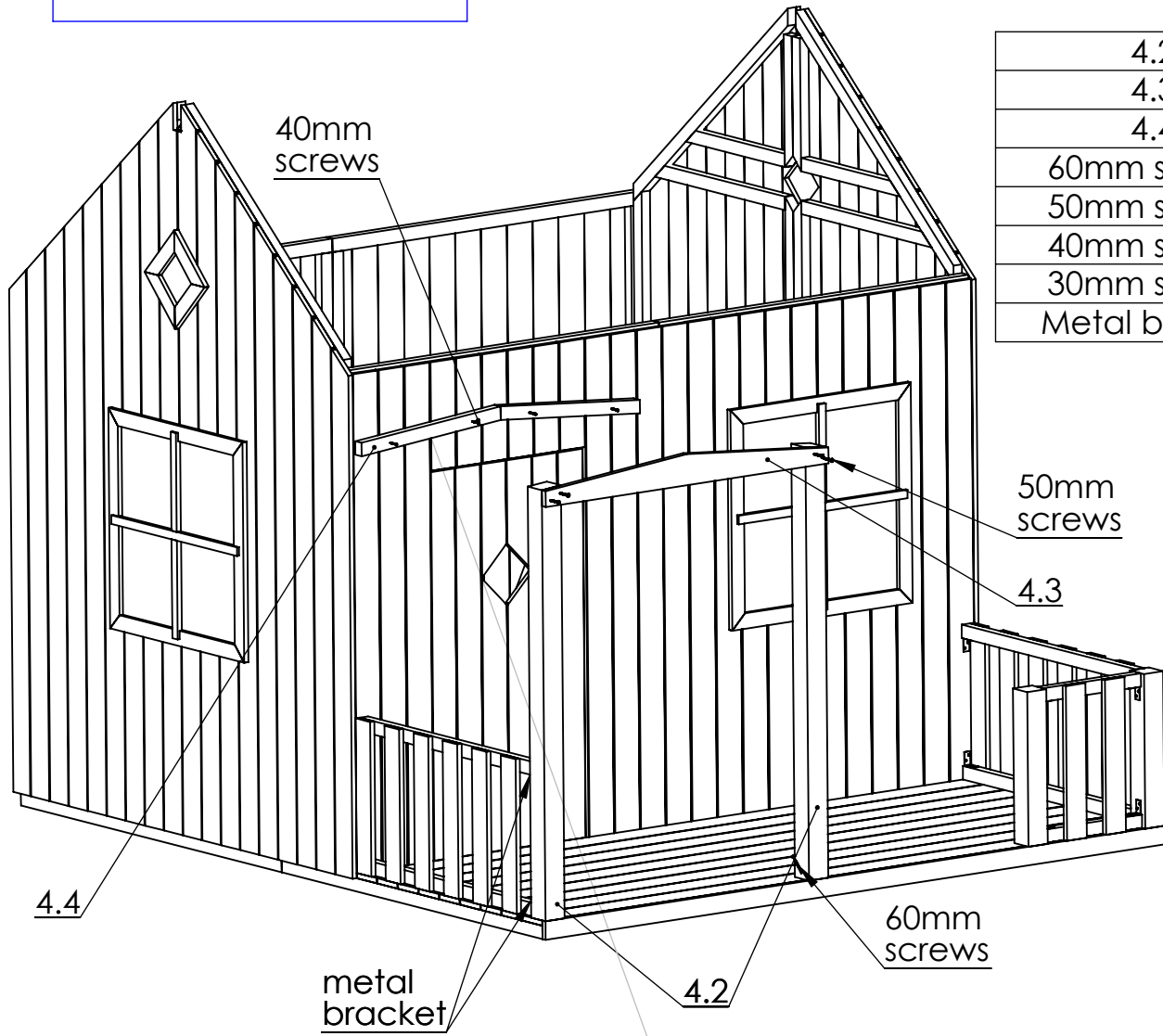

4.2	2
4.3	1
4.4	2
60mm screws	2
50mm screws	4
40mm screws	4
30mm screws	8
Metal bracket	2

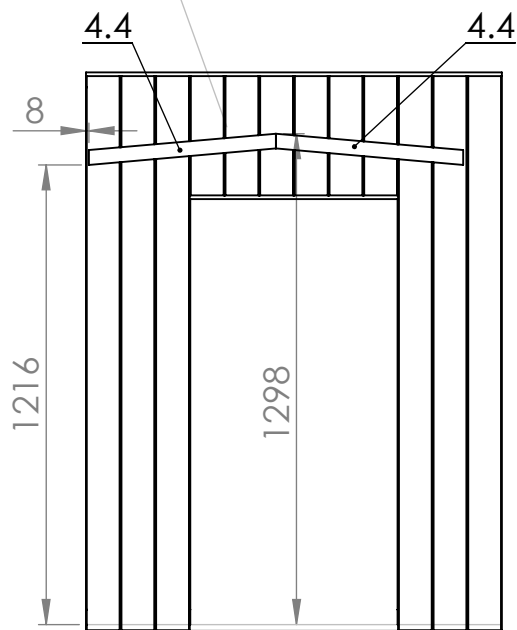

NB! Drill the pilot holes for the screws

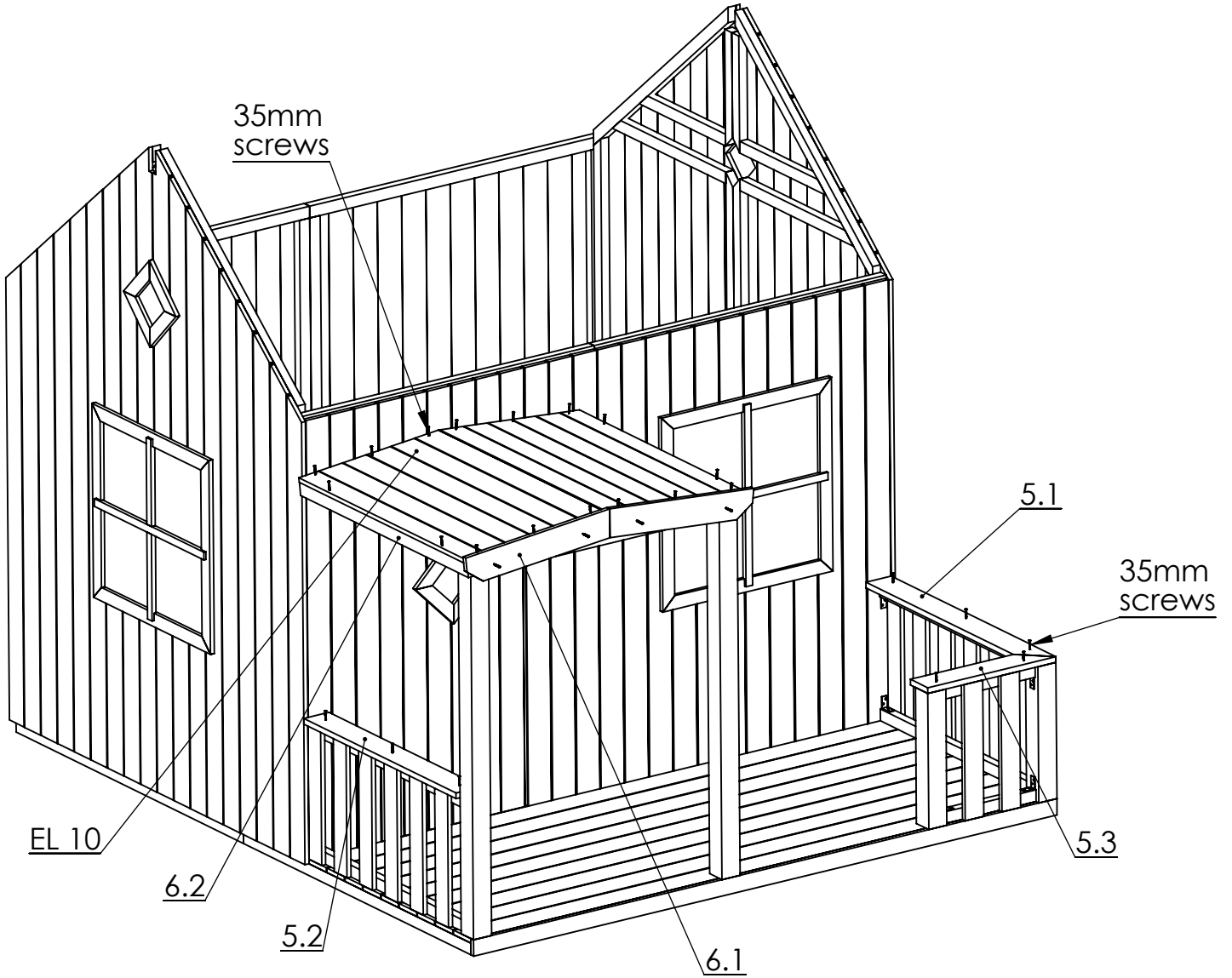

EL 10	2
35mm screws	12
5.1	1
5.2	1
5.3	1
35mm screws	8
6.1	2
6.2	2
35mm screws	10

NB! Drill the pilot holes for the screws

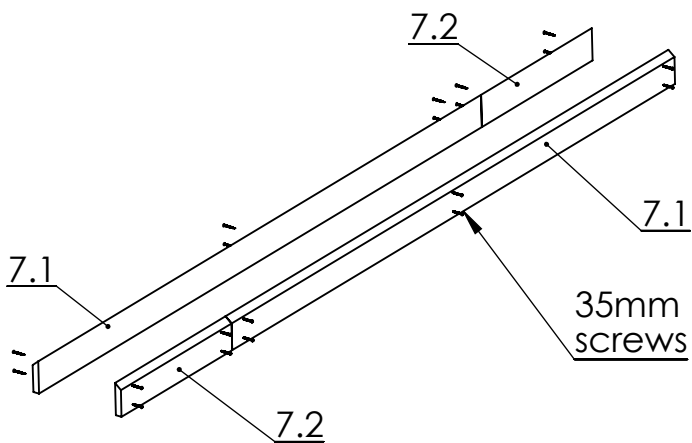
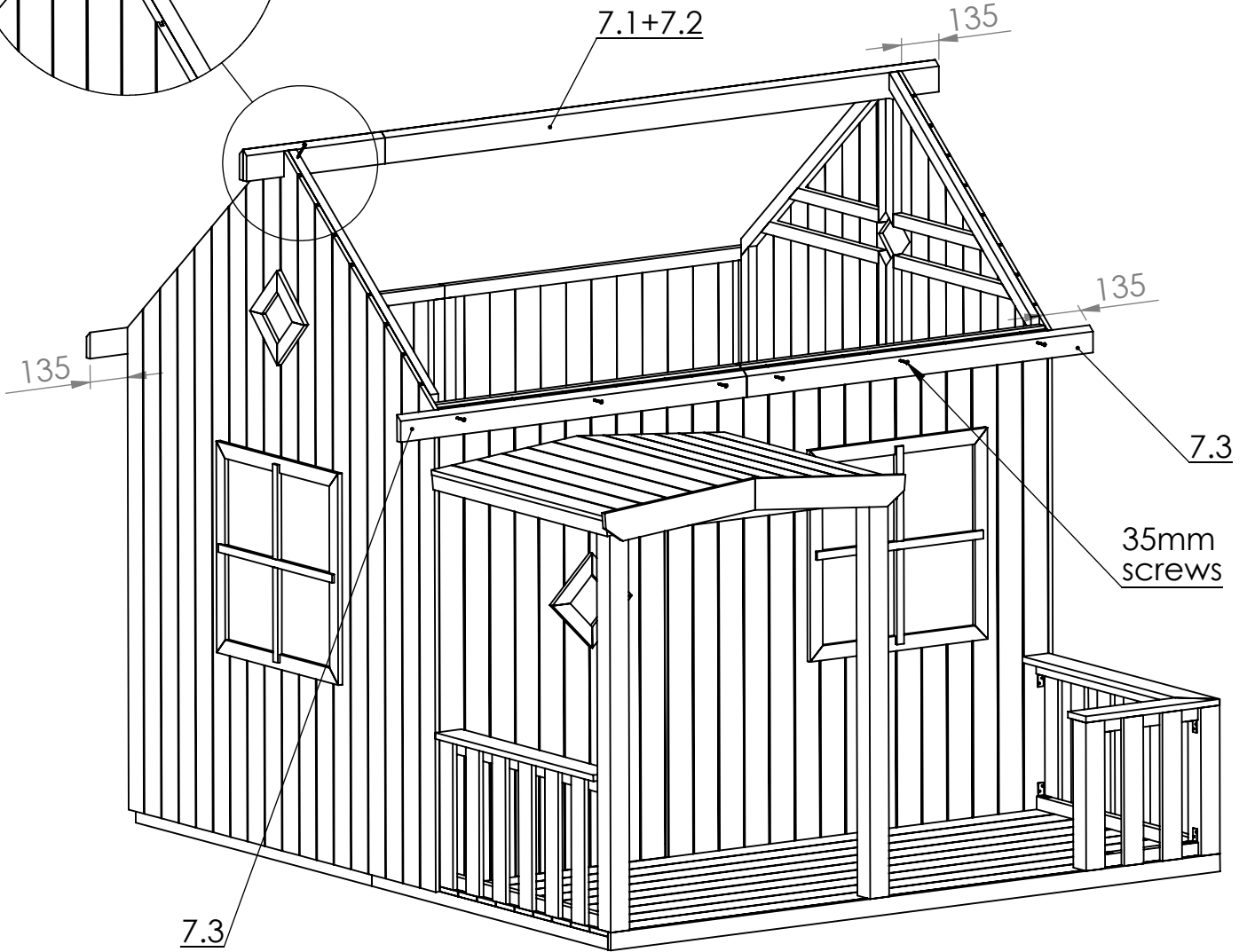
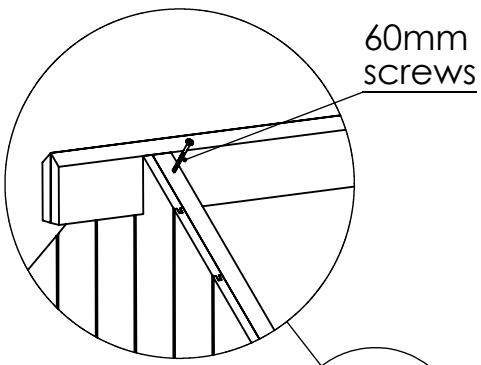

7.1	2
7.2	2
35mm screws	20
60mm screws	4
7.3	4
35mm screws	12

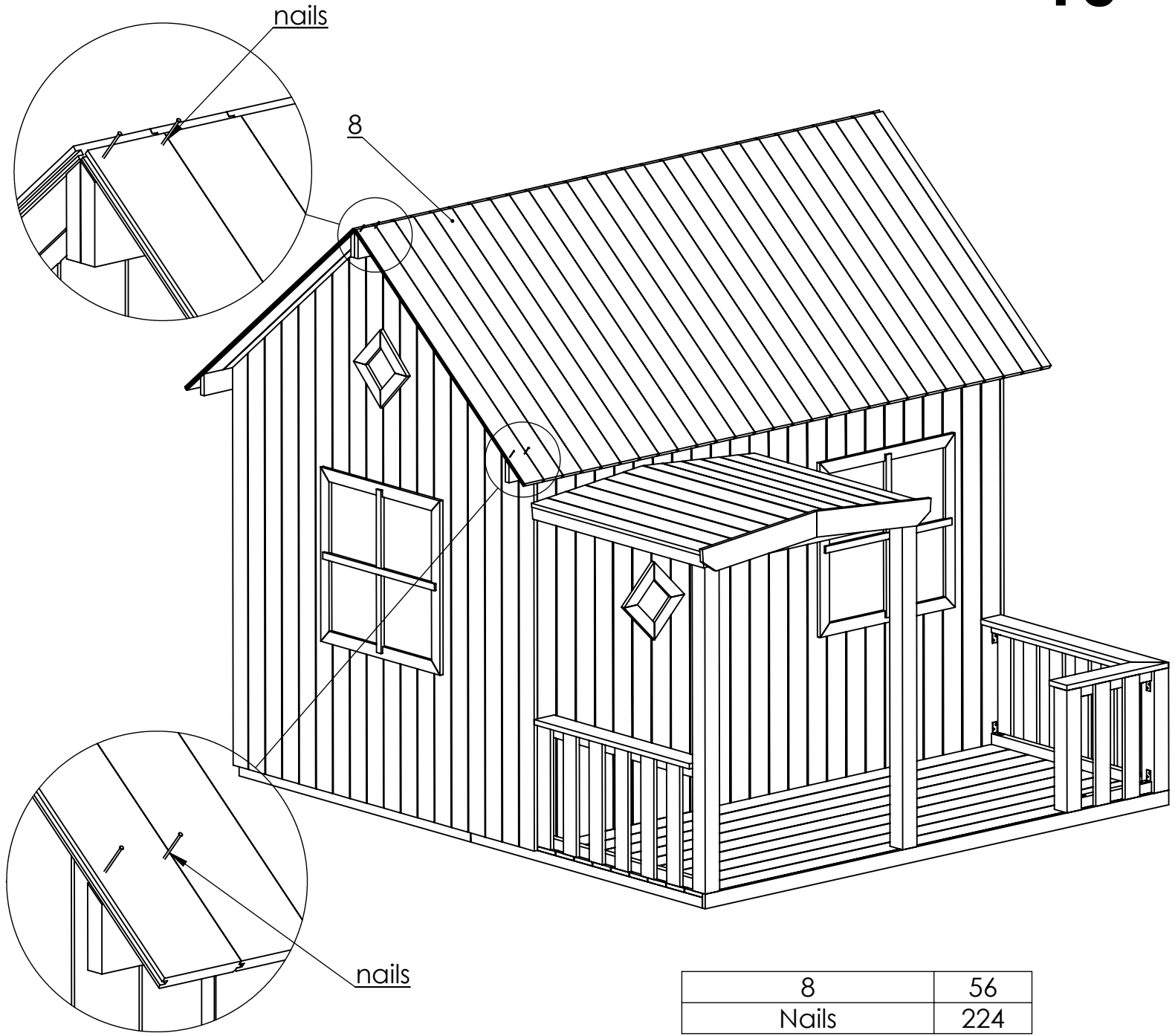

8	56
Nails	224

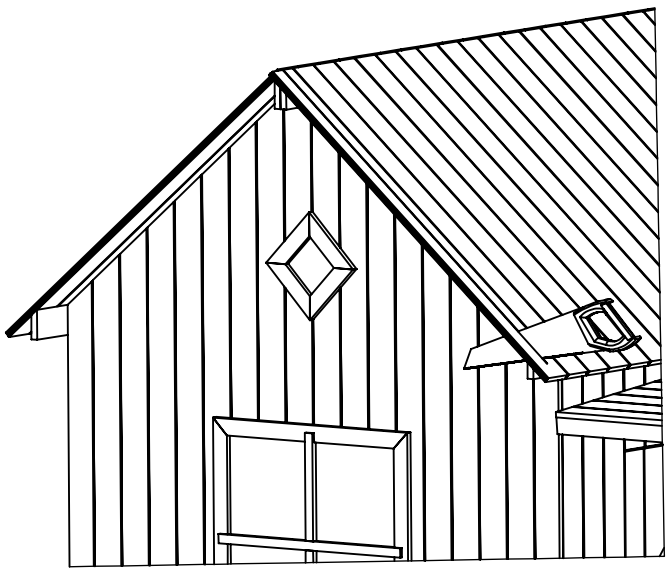

NB! Drill the pilot holes for the screws

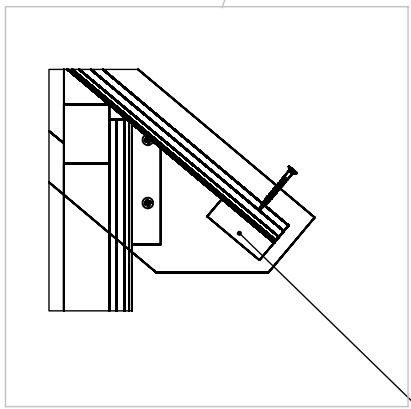
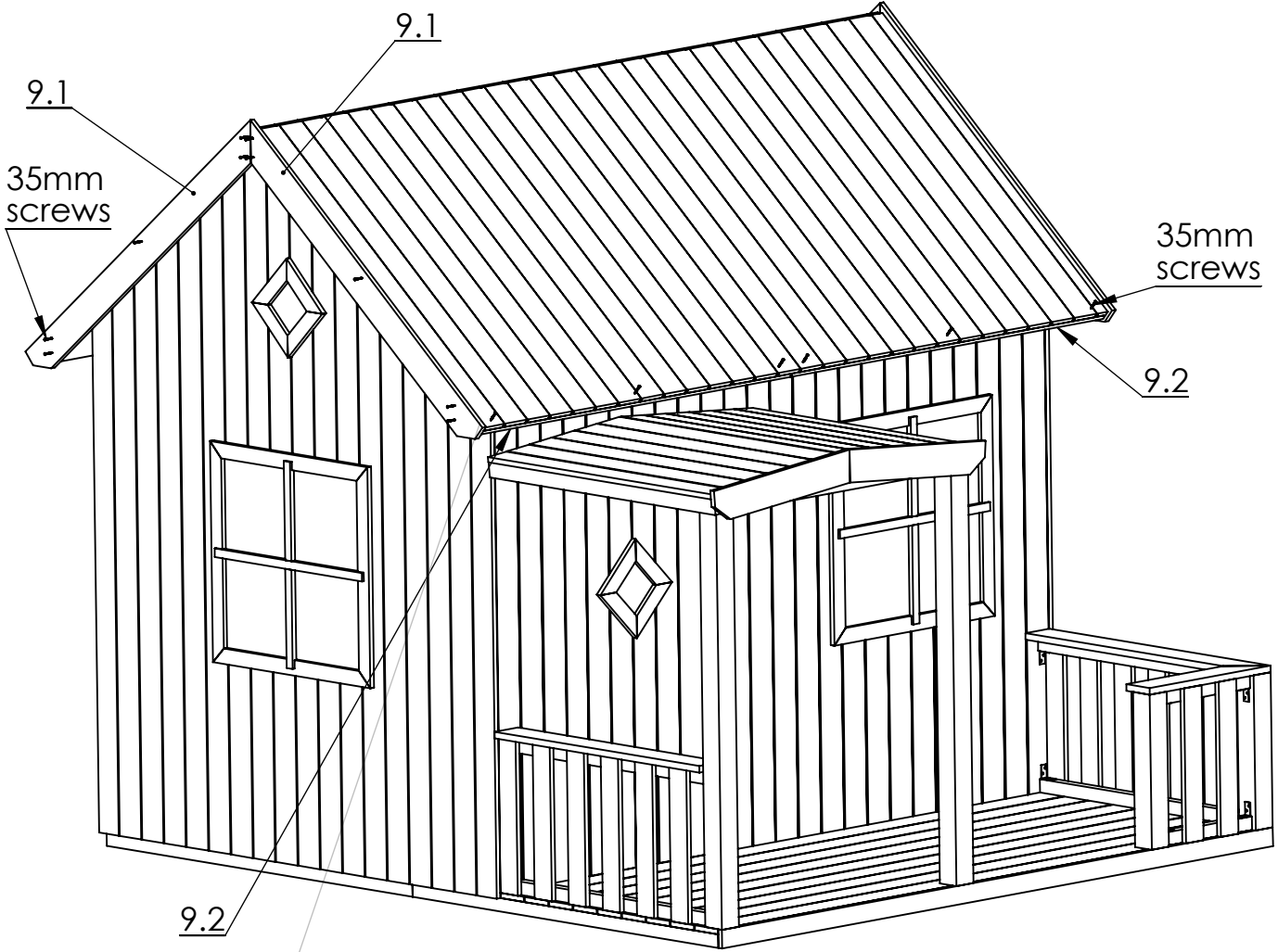

9.1	4
9.2	4
35mm screws	32

NB! Drill the pilot holes
for the screws

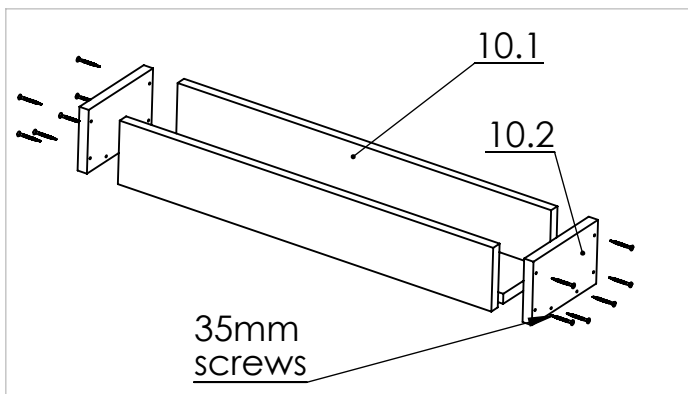
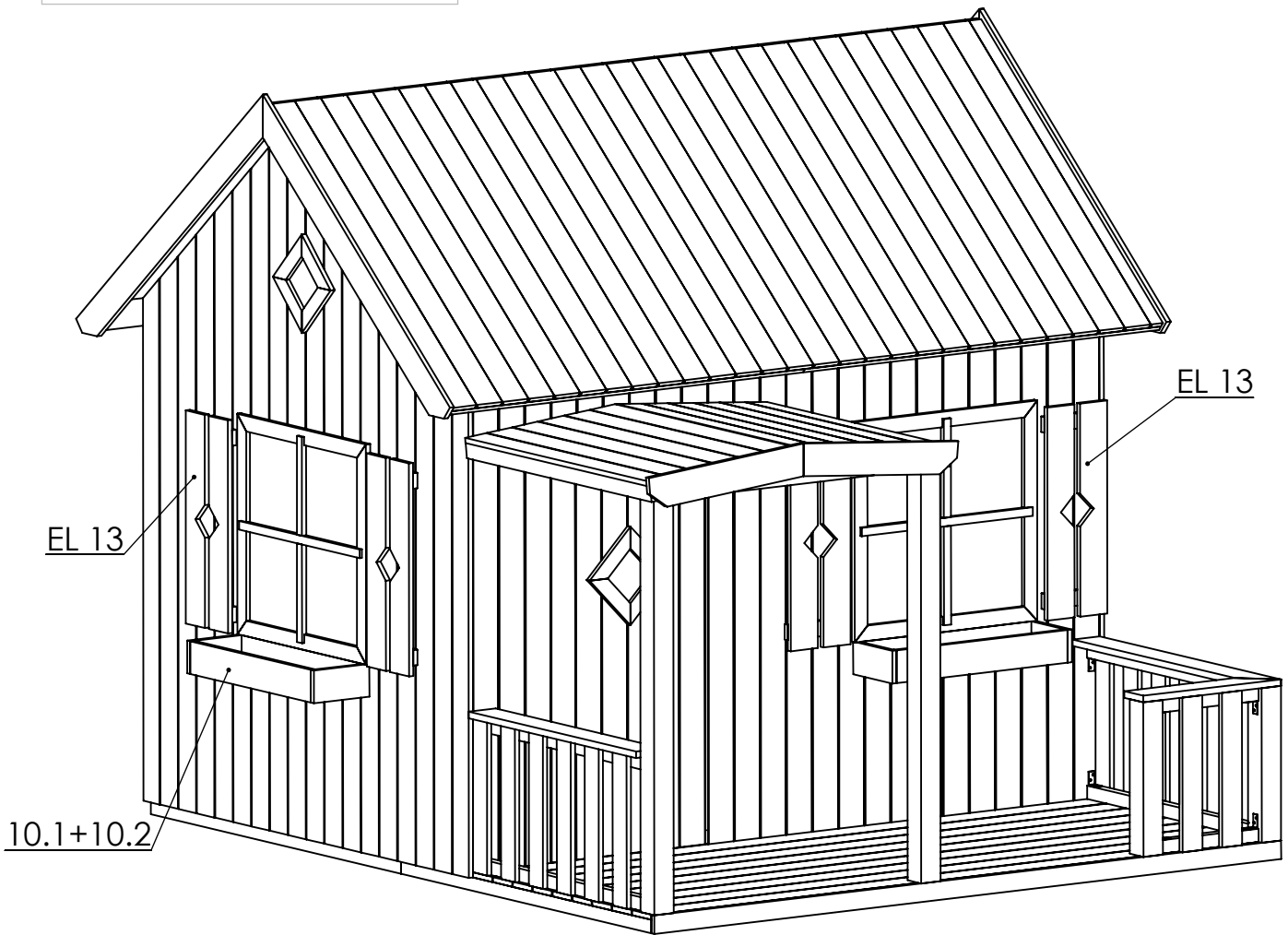

10.1	6
10.2	4
35mm screws	24
30mm screws	4
EL 13	4
30mm screws	8