

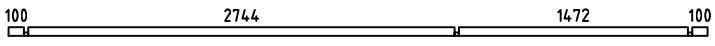

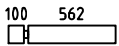

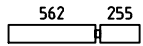



Isak28

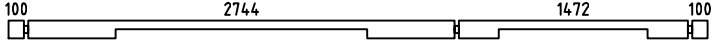
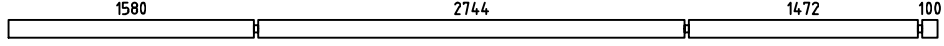
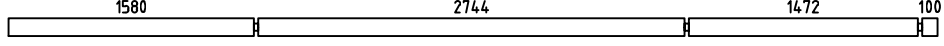
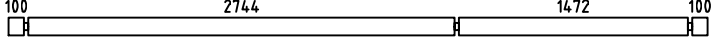
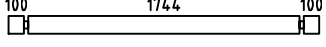
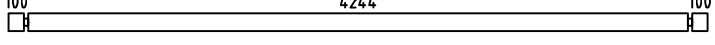
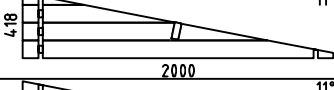
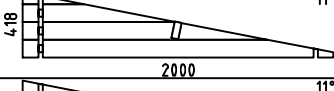
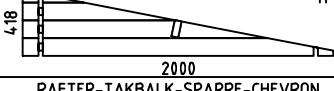
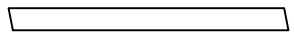
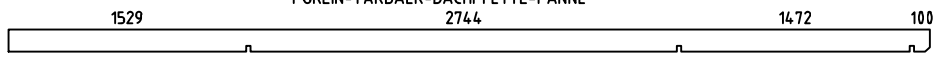
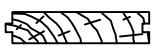
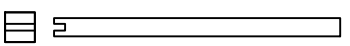
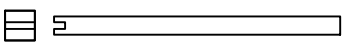

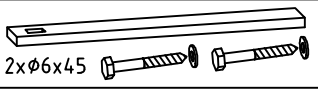
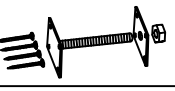
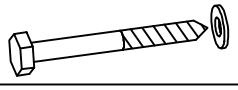
Pos	Specification-Spezifikation-Specificatie Isak28	St.	Profile (mm)	Length (mm)
001		2	28x57	4500
002		16	28x114	690
003		16	28x114	845
004		16	28x114	385
005		1	28x114	4500
006		2	28x114	5980
007		2	28x114	5980
008		14	28x114	4500
009		48	28x114	2000
EXTRA		1	28x114	4500
WB-1		1		
WC-1		1		
WD-1		1		
RT1	RAFTER-TAKBALK-SPARRE-CHEVRON 	1	44x144	1804
PL1	PURLIN-TAKBALK-DACHPFETTE-PANNE 	1	44x144	5930
R-1	ROOF BOARD-TAKBRÄDA-DACHBRETT-VOLIGE 	68+1 53+1	88x18 114x18	2250
	-POST 85x85 	1		1700
	-POST 85x85 	1		2040
GB-1	GABLE BOARD 120-GAVELBRÄDA-GIEBELLENDE-PLANCHE DE RIVE 	2	18x120	2290
GB-2	GABLE BOARD 120-GAVELBRÄDA-GIEBELLENDE-PLANCHE DE RIVE 	4	18x120	3010
SS-1	STORM SLAT KIT-STORMSÄKRINGSLIST-STURMLEISTE SATZ-KIT DE LATTE ANTI TEMPÊTE 	4	18x40	2000
	ADJUSTMENT BOLT KIT-PELARINFÄSTNING-EINSTELLBOLZEN-BOULON DE RÉGLAGE 	2		
C8x80	COACH SCREW KIT 8x80-BULT-COACH SCHRAUBE SET-TIREFOND 	6	8x80	
Model	Isak28	Material	2.8x11.4	Page 1/2

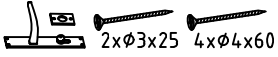
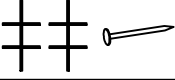
Pos	Specification-Spezifikation-Specificatie Isak28	St.	Profile (mm)	Length (mm)
	DOOR KIT-DÖRR BESLAG-TÜR SATZ-KIT PORTE 	1		
	DOUBLE DOOR KIT-DUBBELDÖRR BESLAG-TÜR SATZ-KIT DOUBLE PORTE  2x $\phi$ 3x25 4x $\phi$ 4x60	1		
	NAIL 1.6x30-SPIK-NAGEL-CLOU 	15	1.6x30	
N 1.8x40	NAIL 1.8x40-SPIK-NAGEL-CLOU 	220	1.8x40	
	DOOR 1600x1850 DD06-6 H 1600x1850-28  	1		
	DOOR 945x1850 SDL H 945x1850-28 R 	1		
Model	Isak28	Material	2.8x11.4	Page 2/2

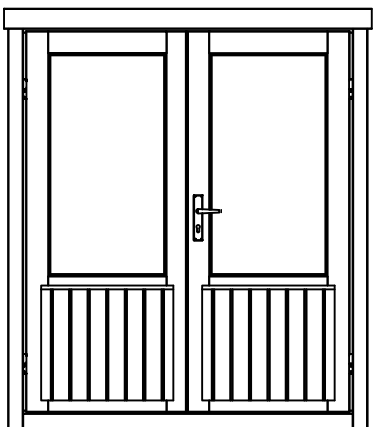
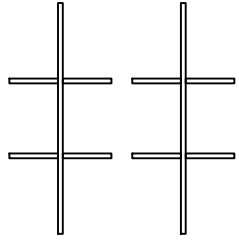
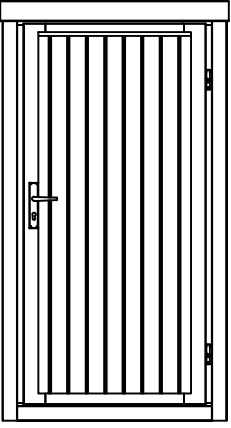
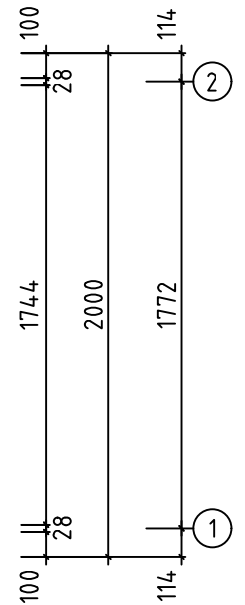
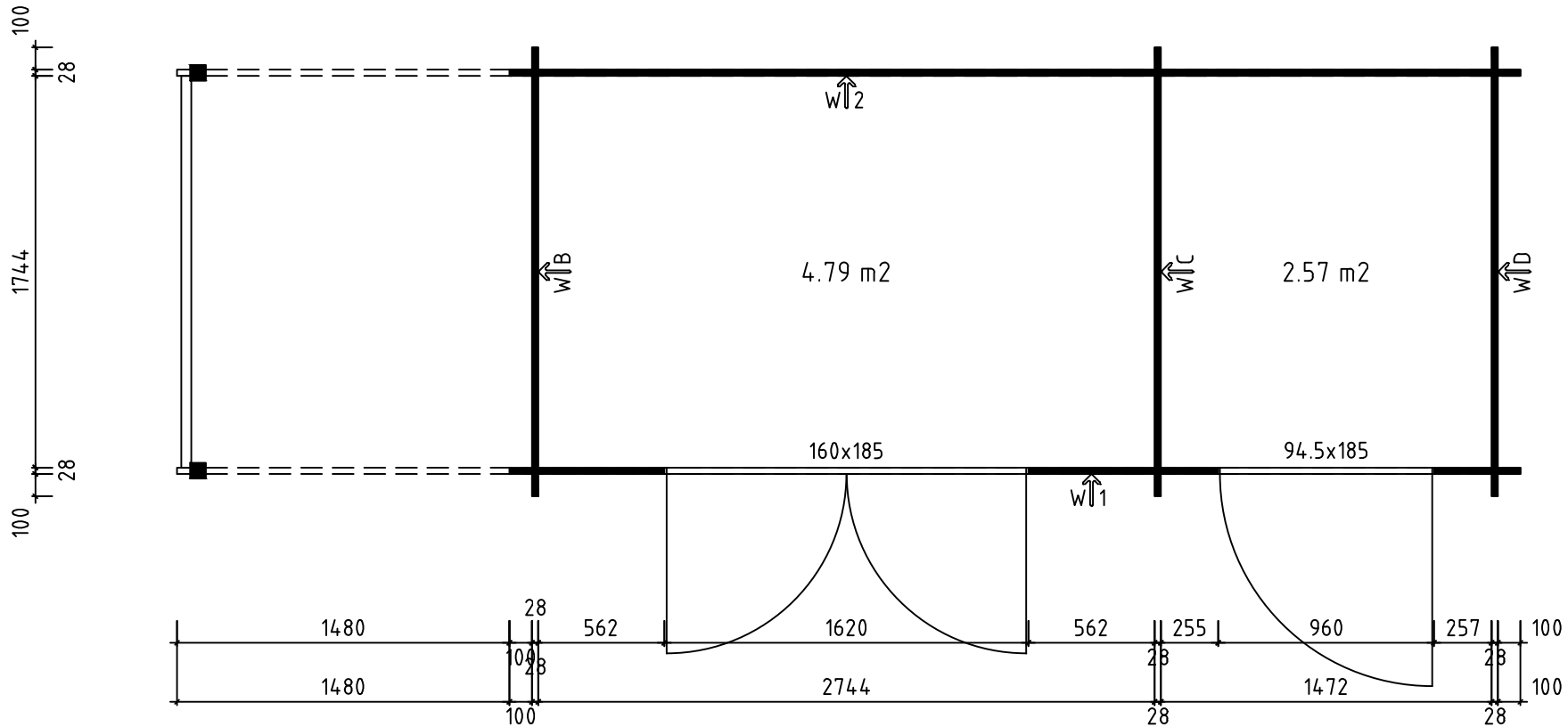
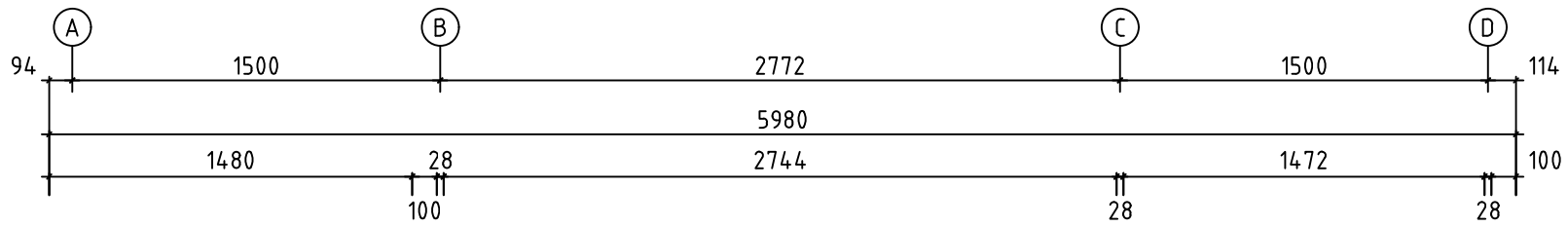

Model	Isak28	Page
Drawing	PLAN	Scale 1:30
Material	2.8x11.4	Date 04.02.2022
File	Isak28.dwg	Drawn by

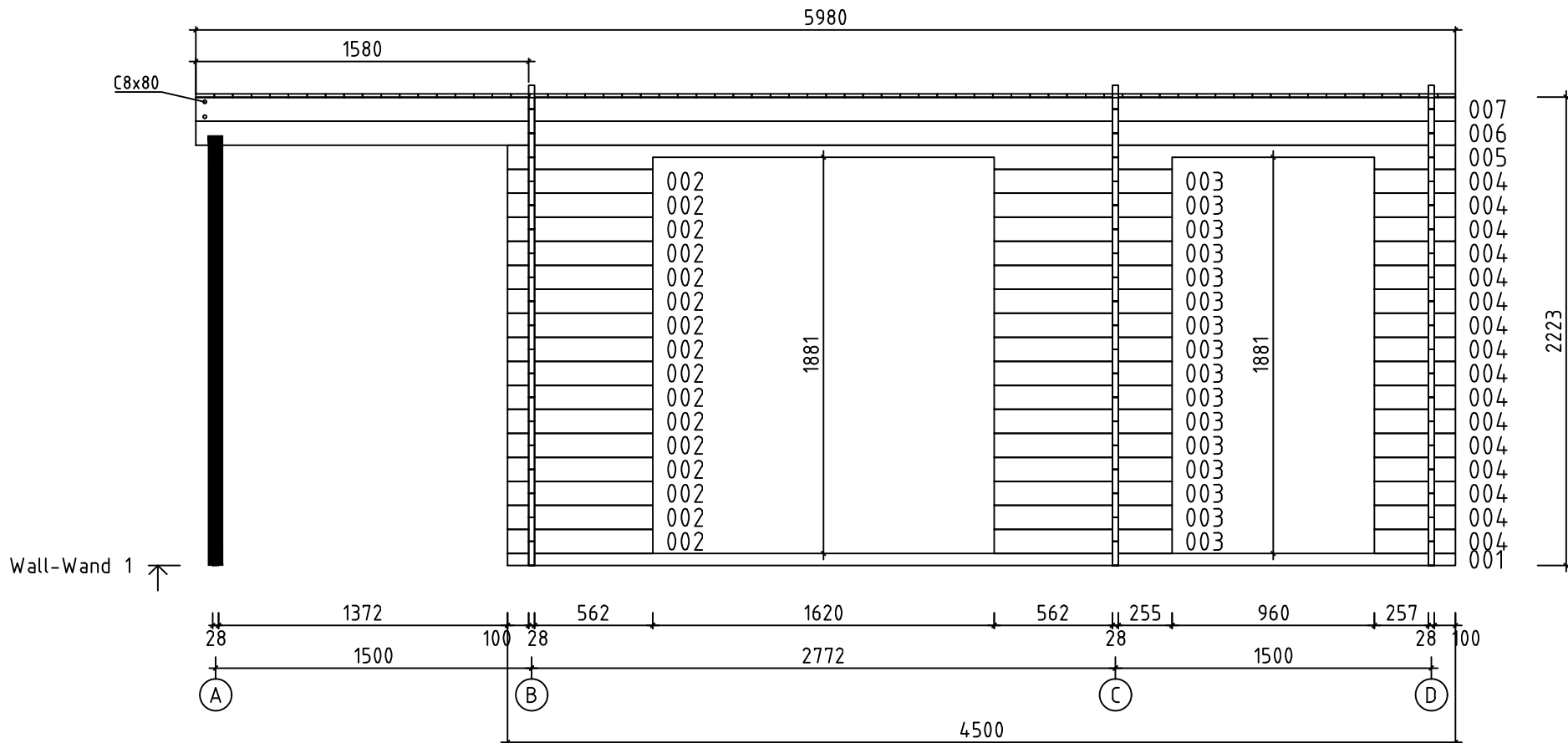

Model	Isak28	Page	7
Drawing	WALL-WAND 1	Scale	1:30
Material	2.8x11.4	Date	04.02.2022
File	Isak28.dwg	Drawn by	

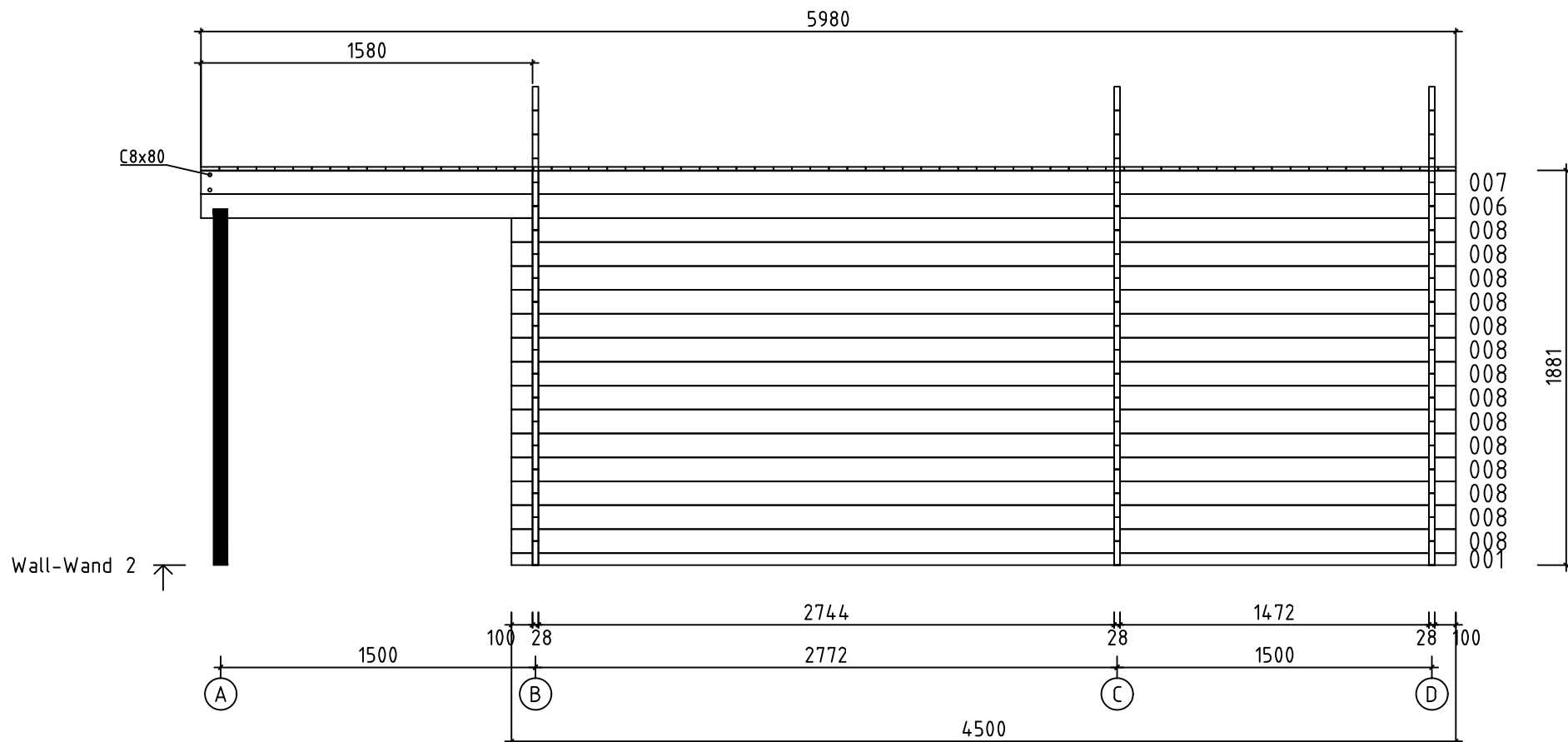

Model	Isak28	Page	8
Drawing	WALL-WAND 2	Scale	1:30
Material	2.8x11.4	Date	04.02.2022
File	Isak28.dwg	Drawn by	

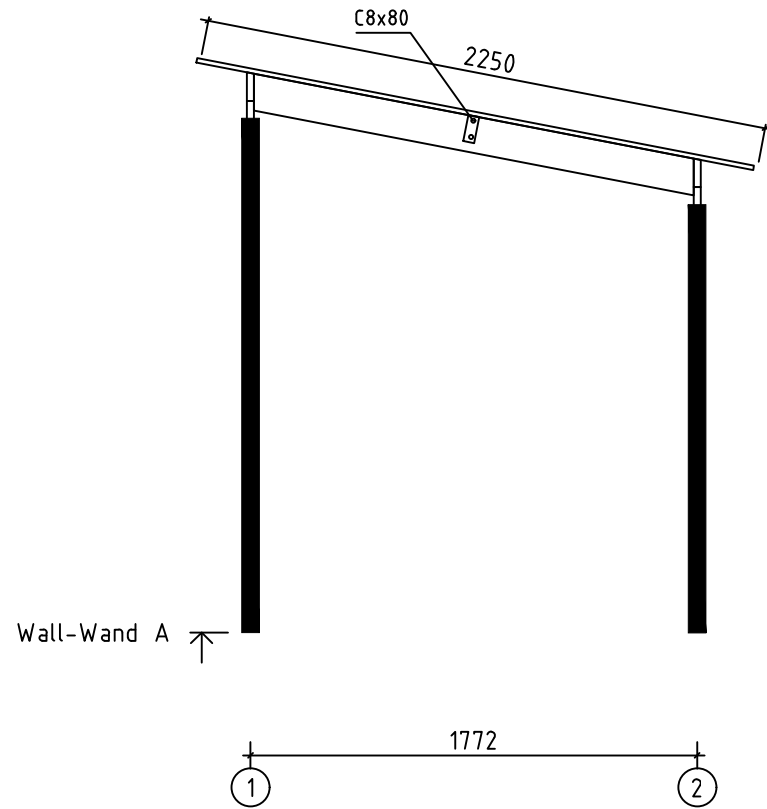

	Model	Isak28	Page	3
	Drawing	WALL-WAND A	Scale	1:30
	Material	2.8x11.4	Date	04.02.2022
	File	Isak28.dwg	Drawn by	

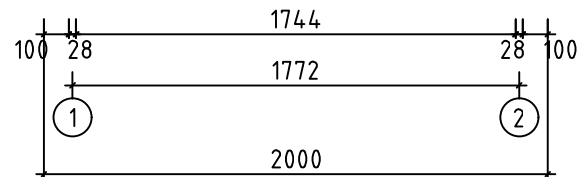
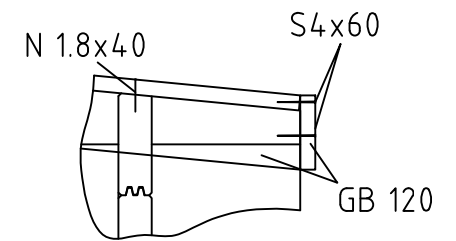
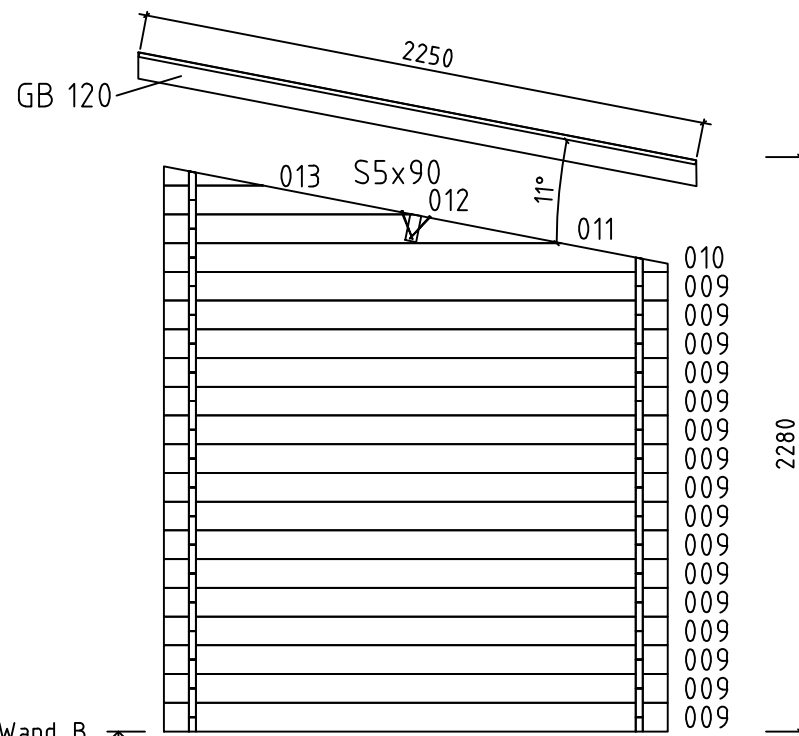
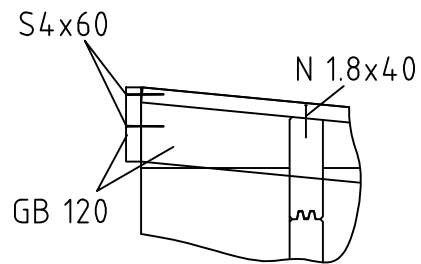



Model	Isak28	Page	4
Drawing	WALL-WAND B	Scale	1:30
Material	2.8x11.4	Date	04.02.2022
File	Isak28.dwg	Drawn by	

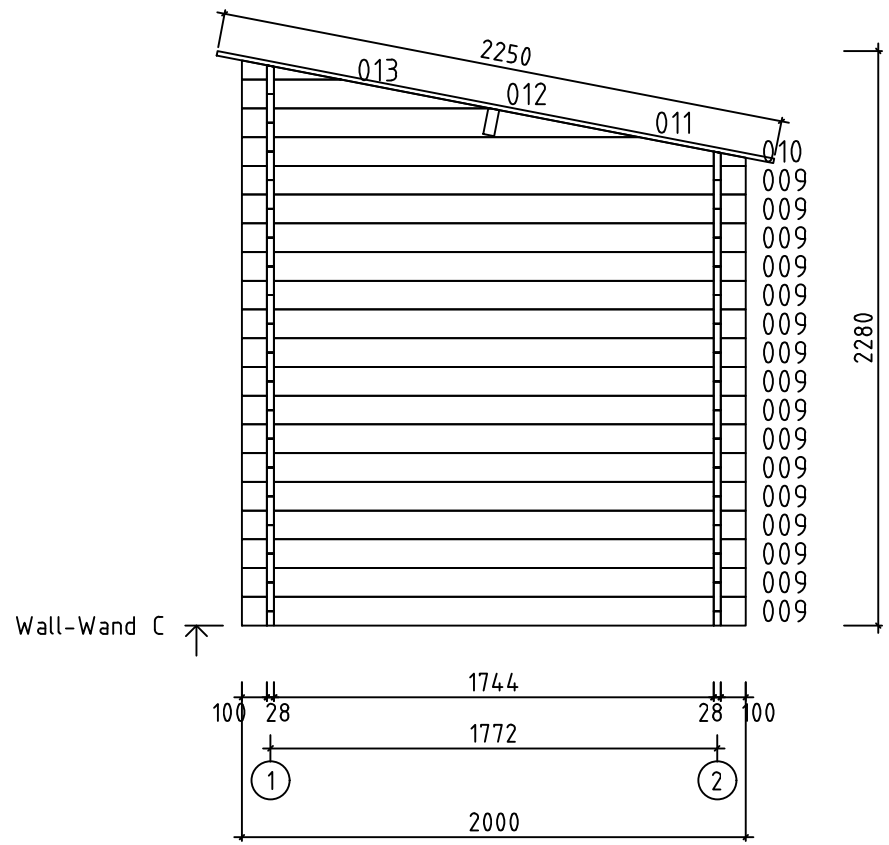

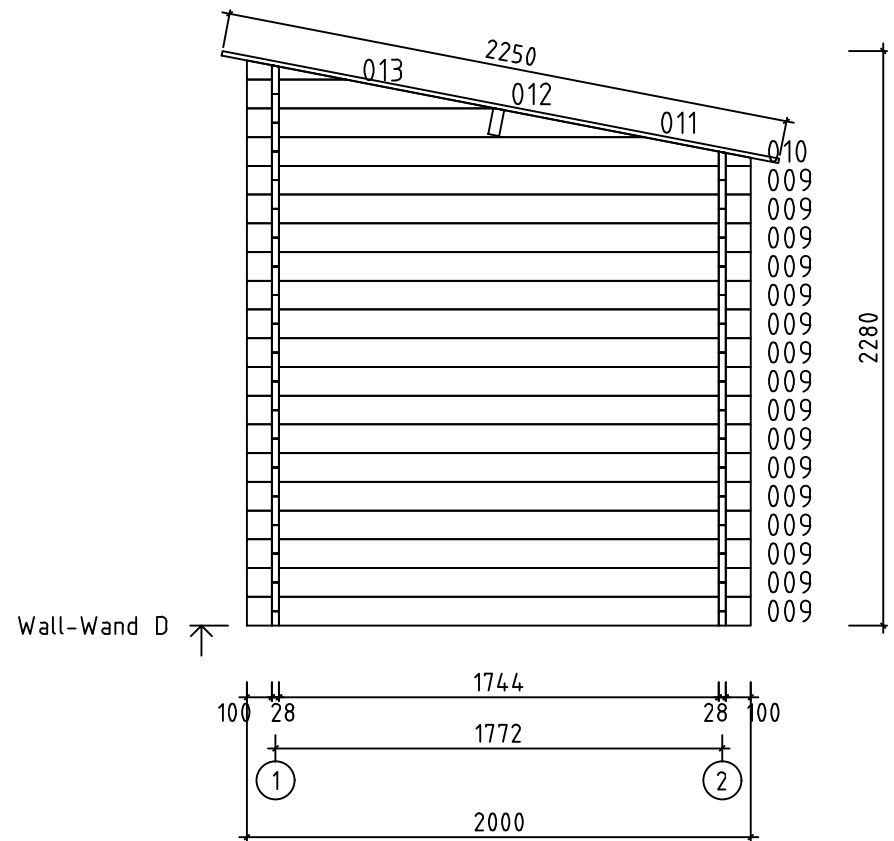

Model	Isak28	Page	5
Drawing	WALL-WAND C	Scale	1:30
Material	2.8x11.4	Date	04.02.2022
File	Isak28.dwg	Drawn by	



	Model	Isak28	Page	6
	Drawing	WALL-WAND D	Scale	1:30
	Material	2.8x11.4	Date	04.02.2022
	File	Isak28.dwg	Drawn by	

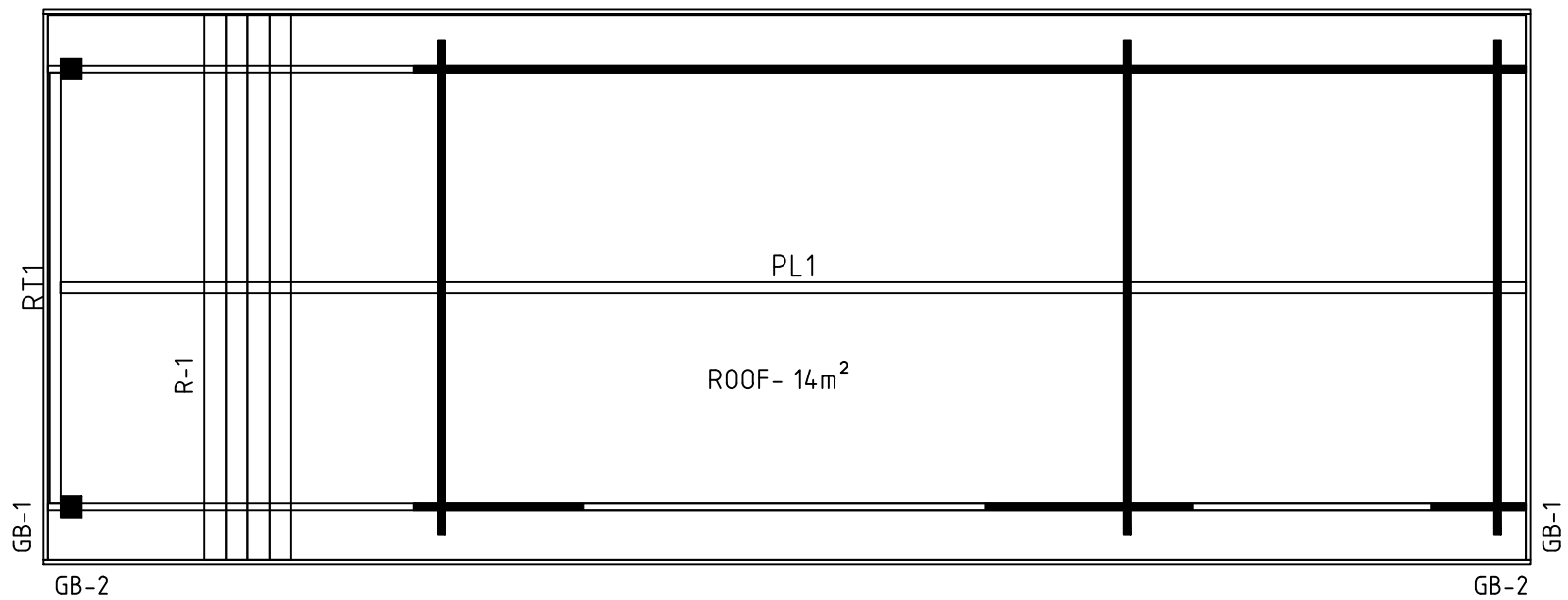

Model	Isak28	Page
Drawing	ROOF	Scale 1:30
Material	2.8x11.4	Date 04.02.2022
File	Isak28.dwg	Drawn by

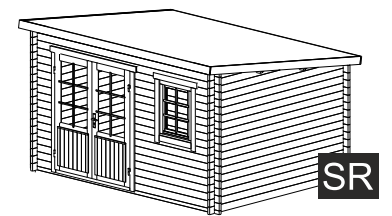
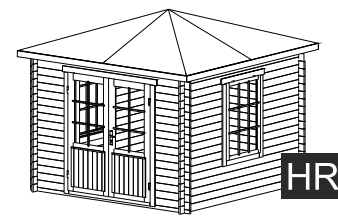
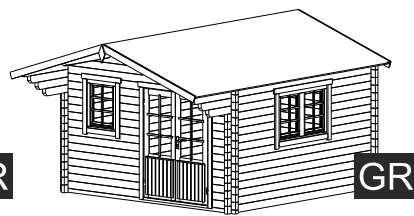
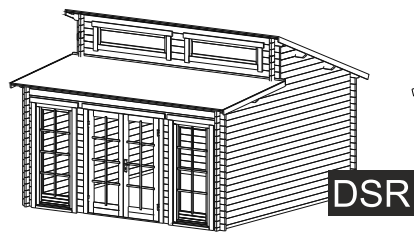
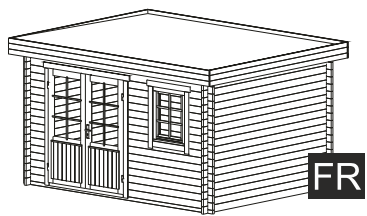

FR

DSR

GR

HR

SR

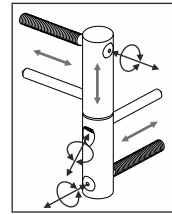
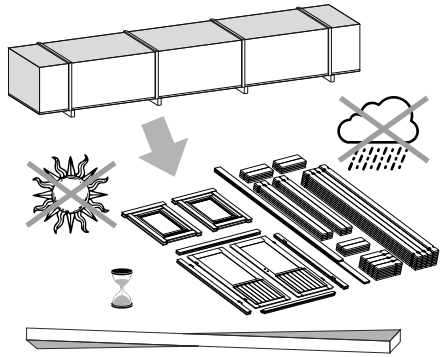

ADJUSTABLE HINGES

3.

TYPE- A  
5x90

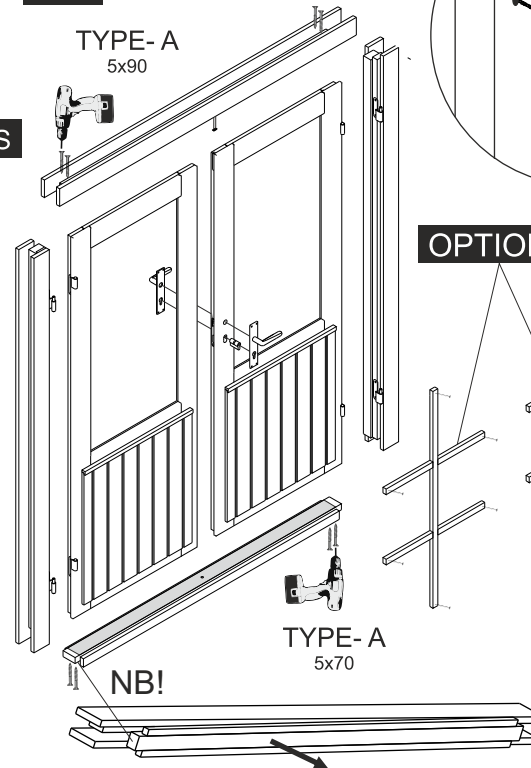

OPTIONS

1. 2.

4.

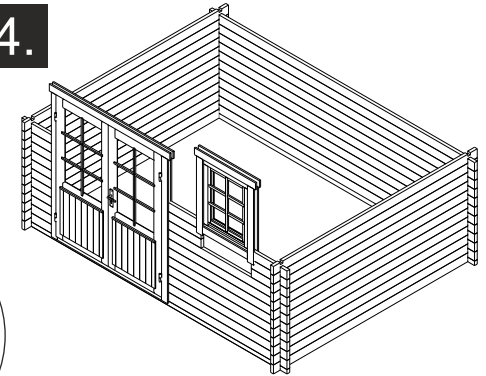

1.

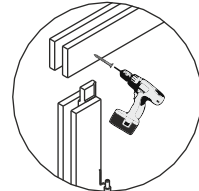
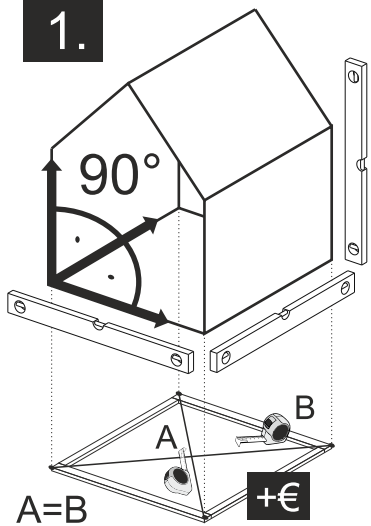

TYPE- B  
4x60

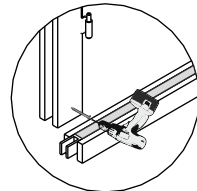

5.

OPTIONS

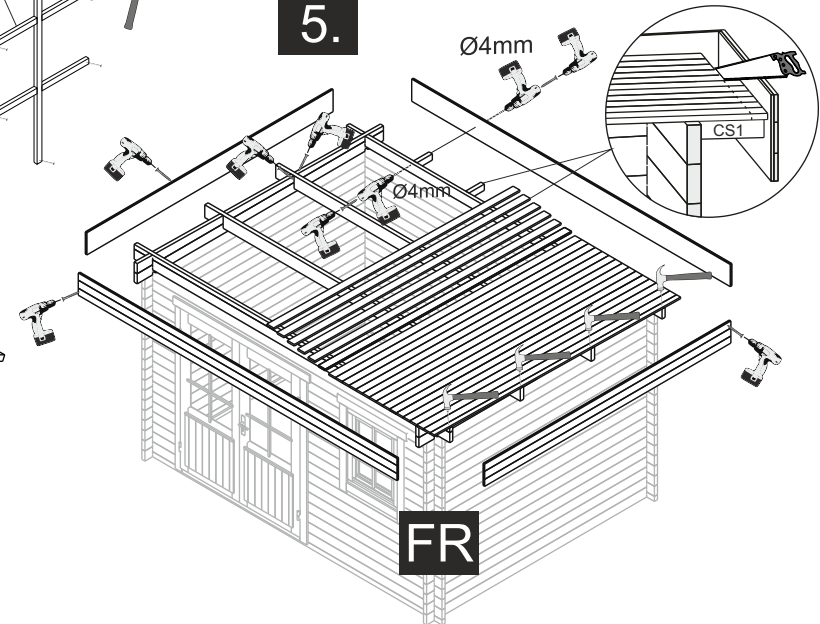

Ø4mm

FR

2.

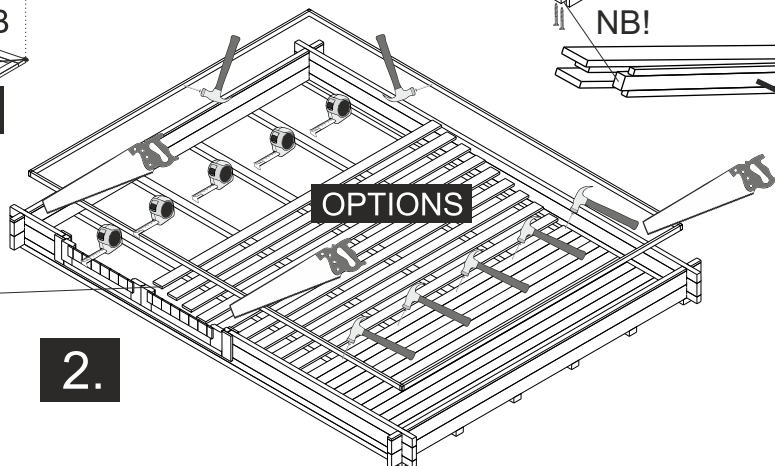

OPTIONS

NB!

TYPE- A  
5x70

The guide is illustrative. This guide is not project specification.  
Der Leitfaden ist illustrativ. Dieser Leitfaden ist keine Projektspezifikation.  
De gids is illustratief. Deze gids is geen projectspecificatie.

5.

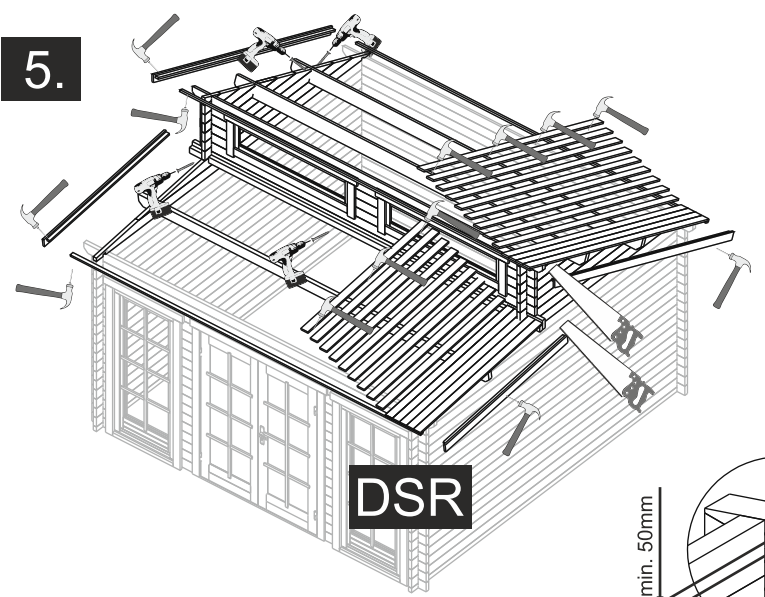

5.

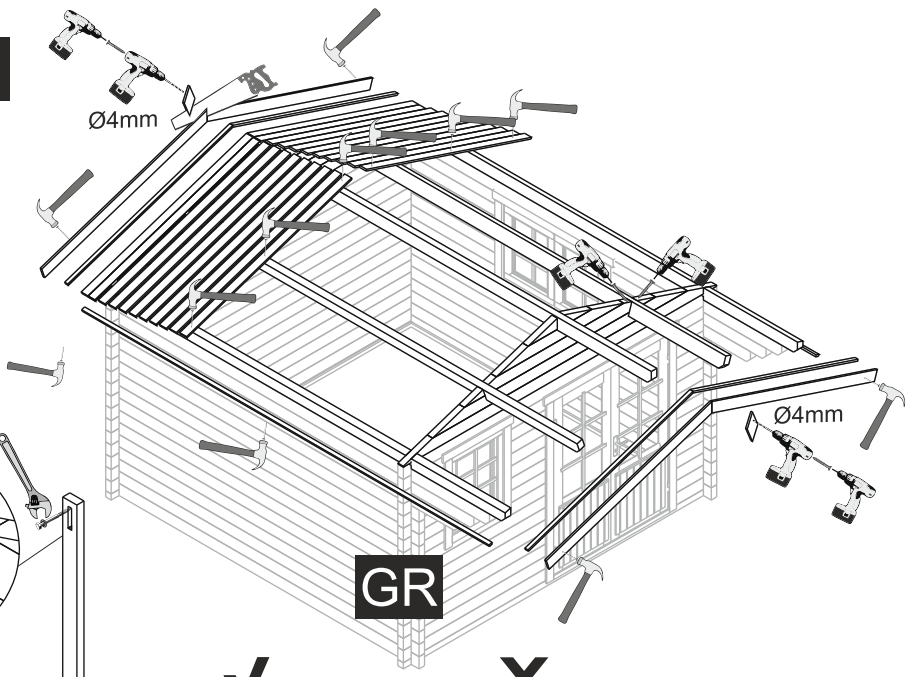

**OPTIONS**

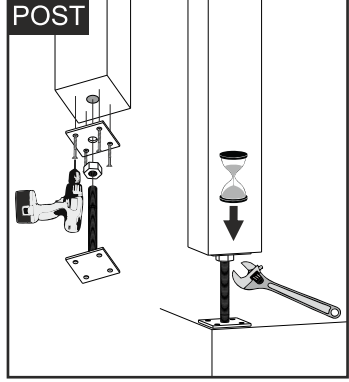
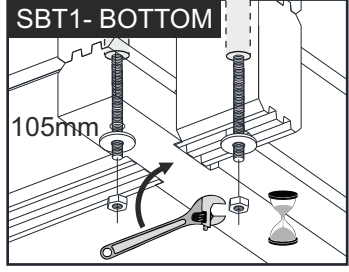
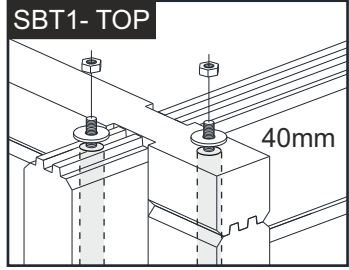
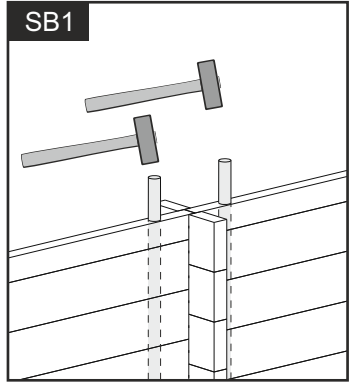

**NB!**

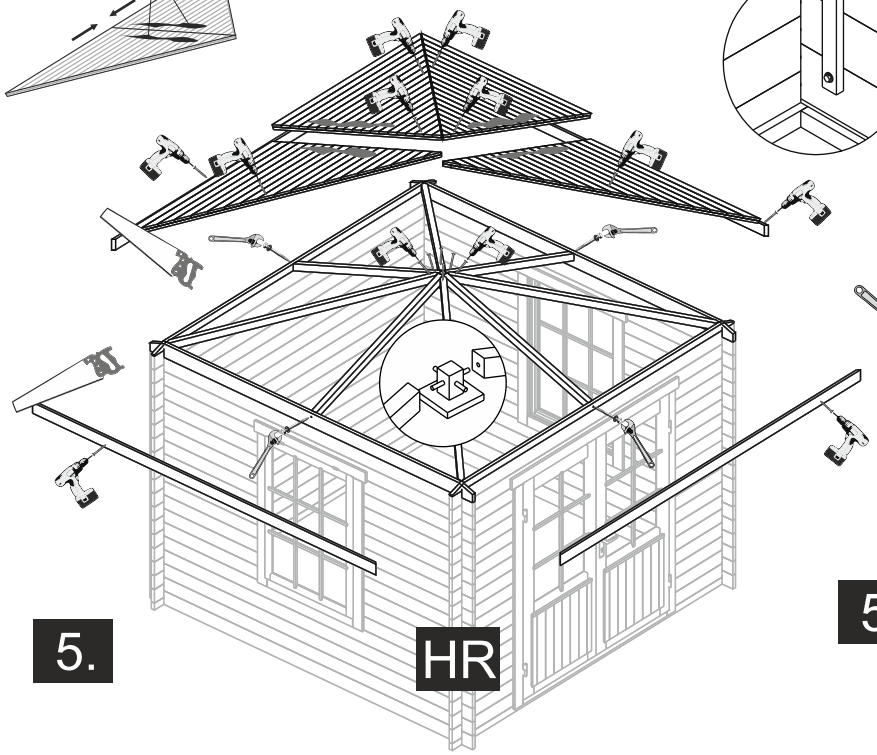

5.

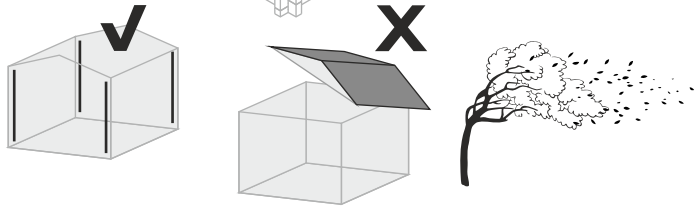
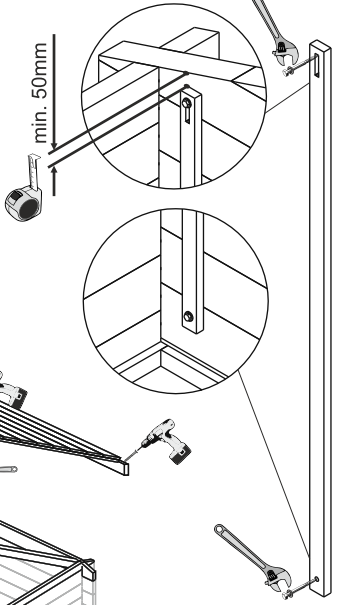

5.

