

Art. Nr. 4432899

1/22

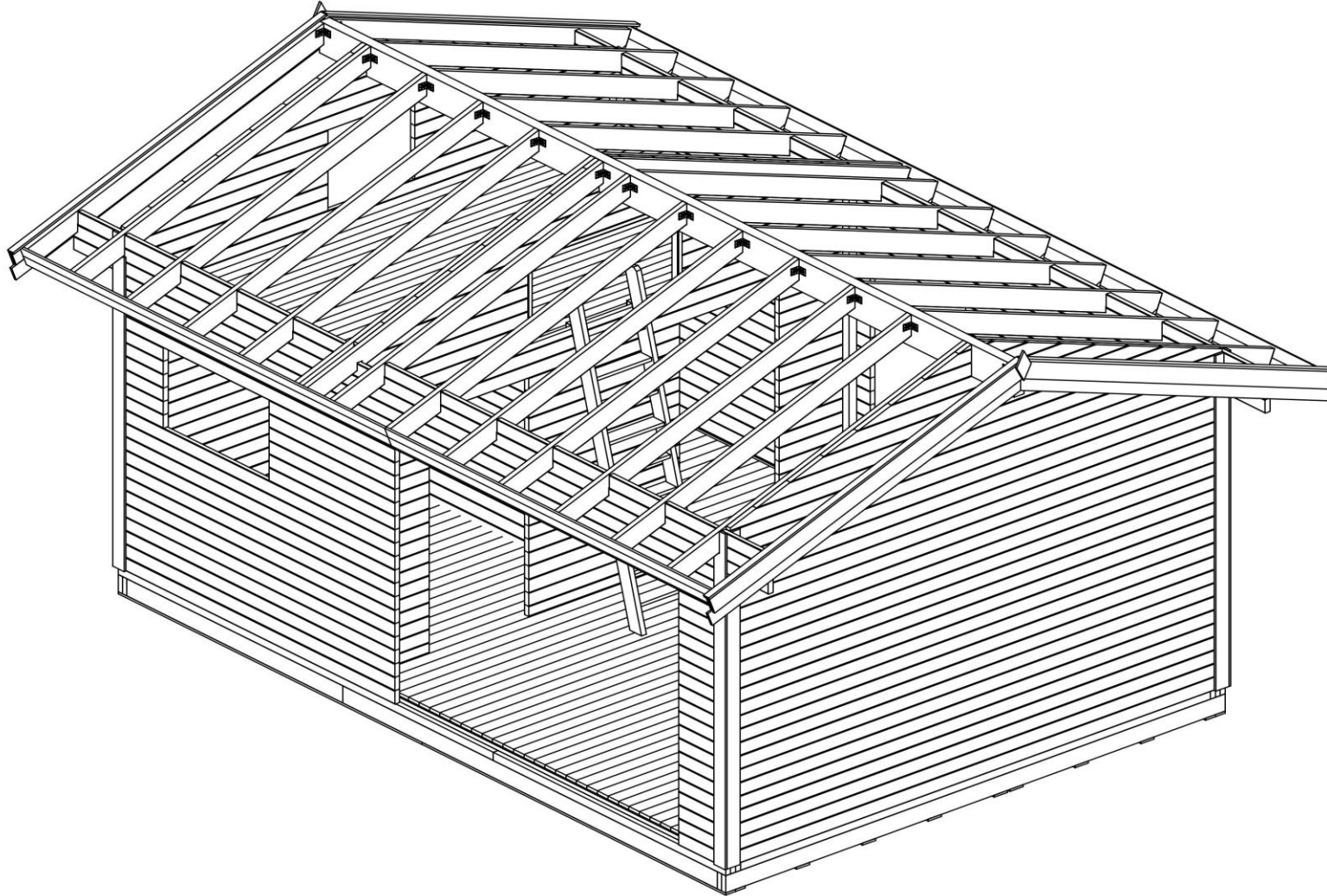

08.05.2024

Art. Nr. 4432899

Groundplan version 1

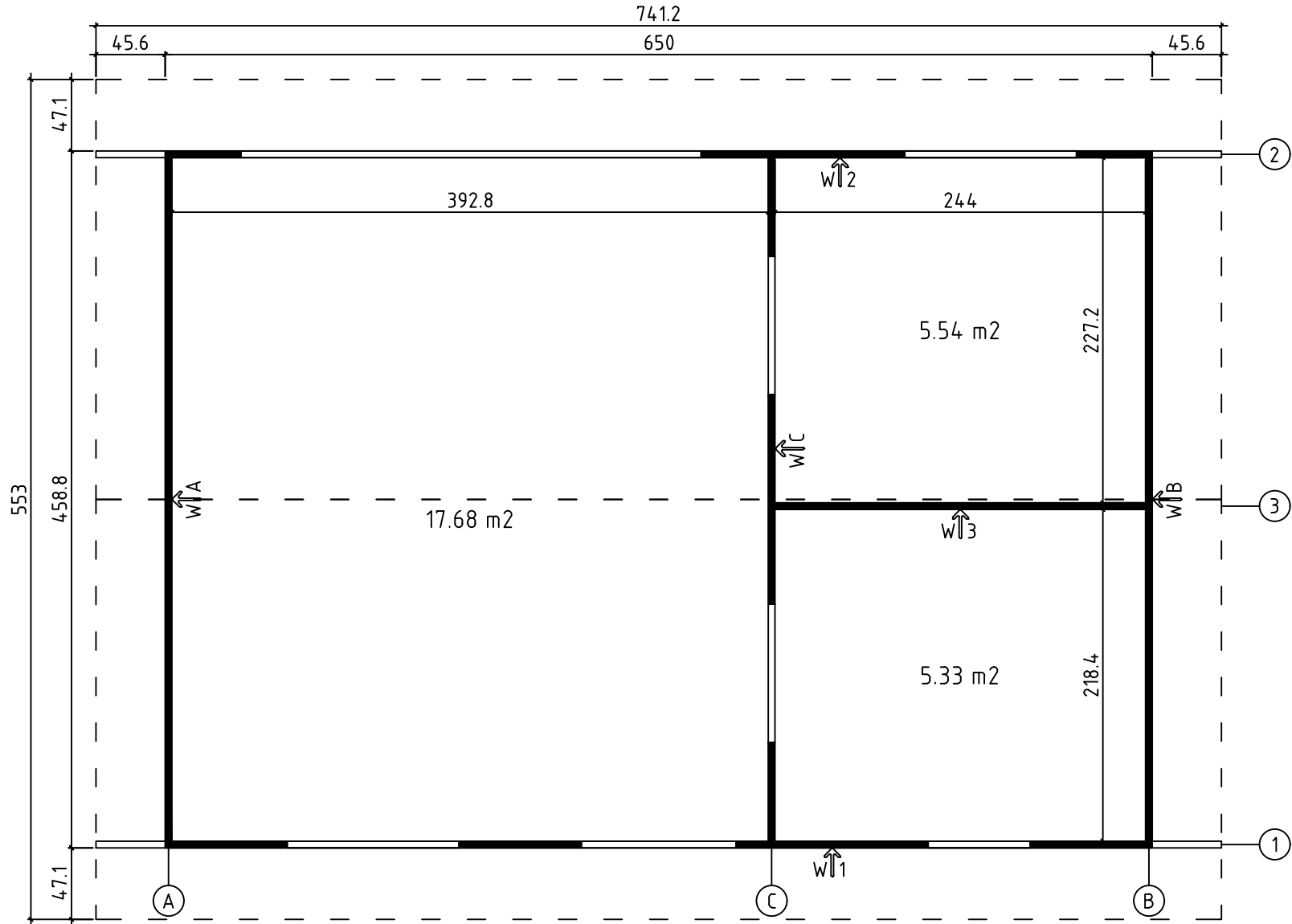

Art. Nr. 4432899

Groundplan version 2

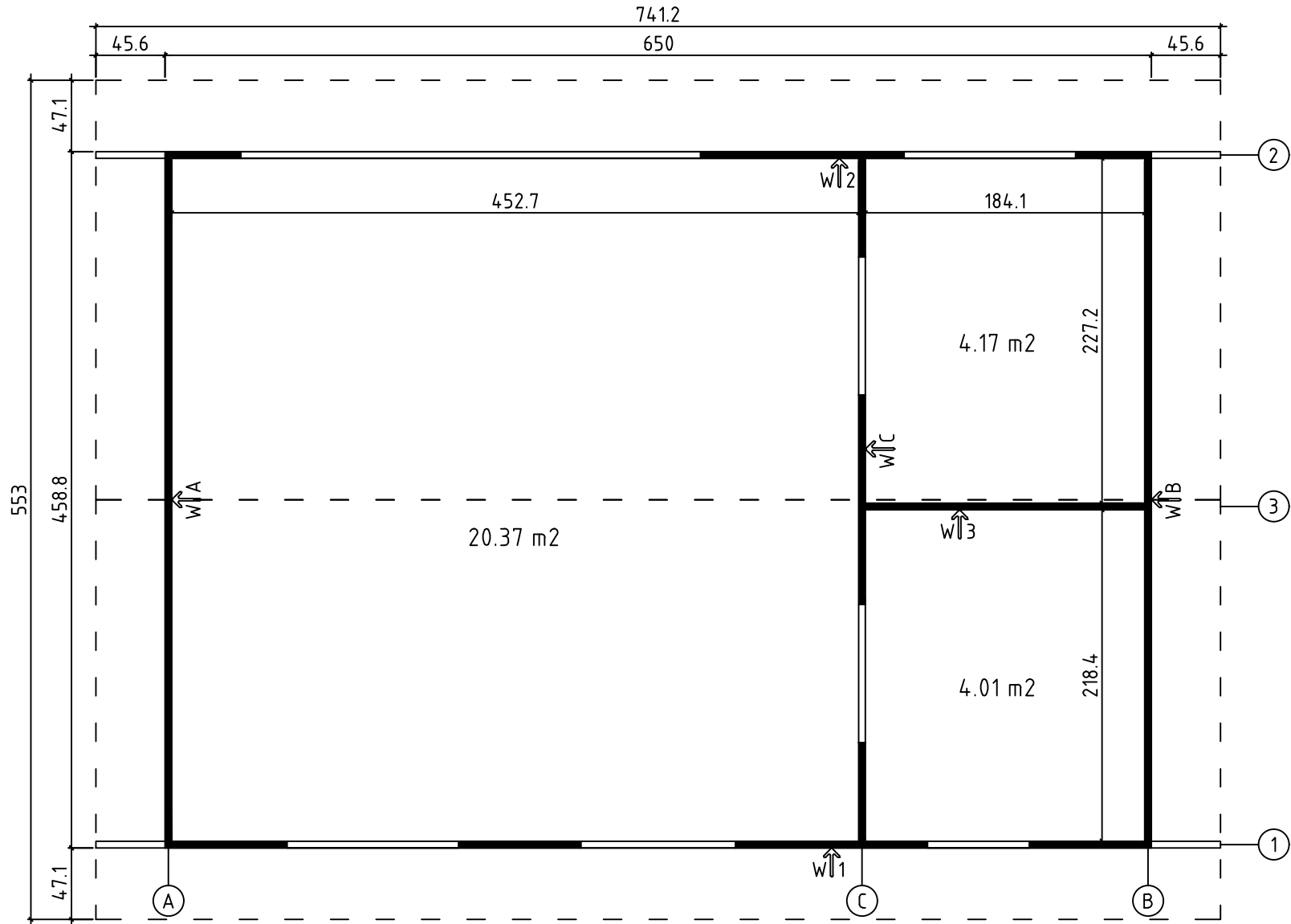

Art. Nr. 4432899

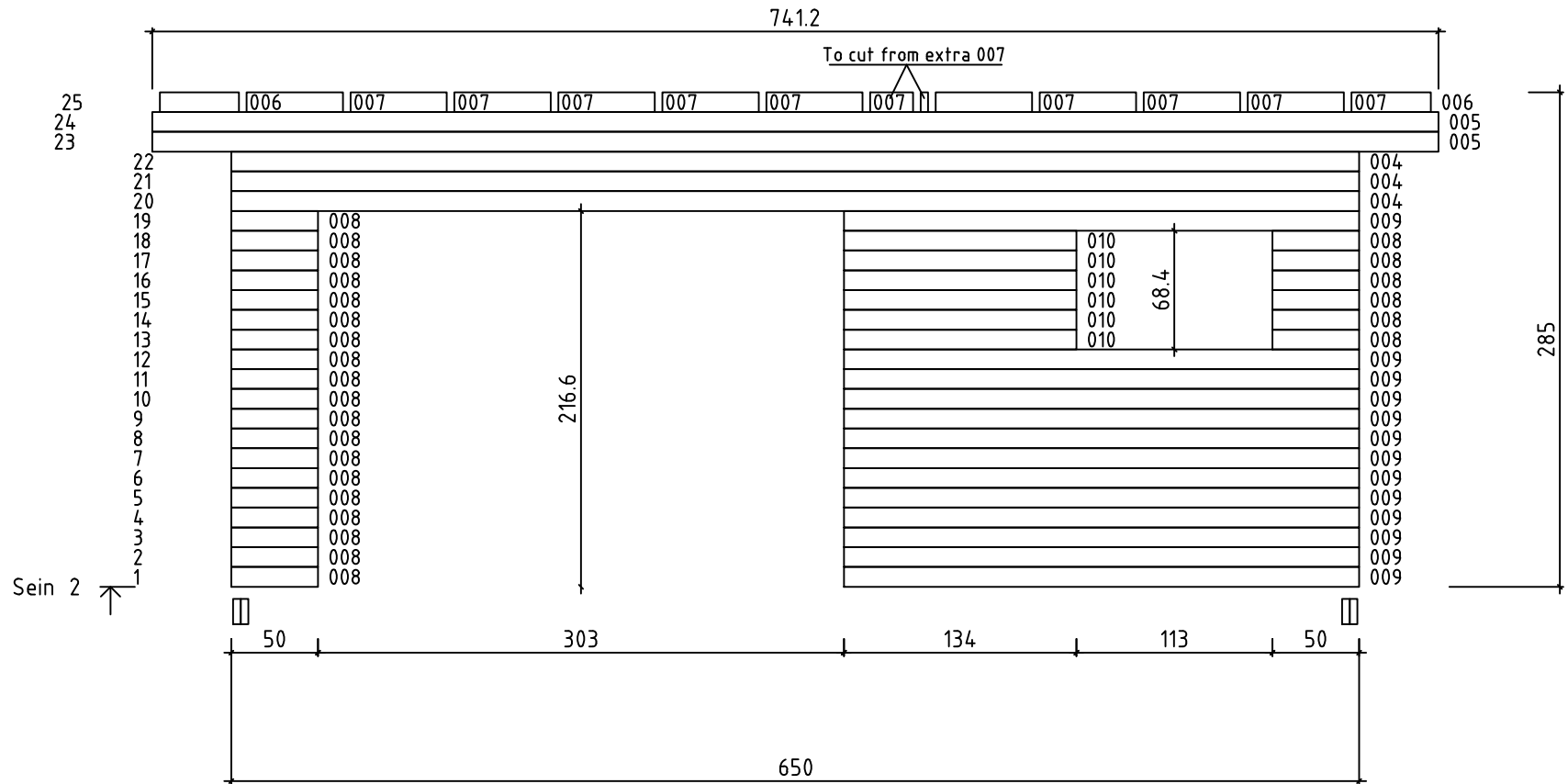

Art. Nr. 4432899

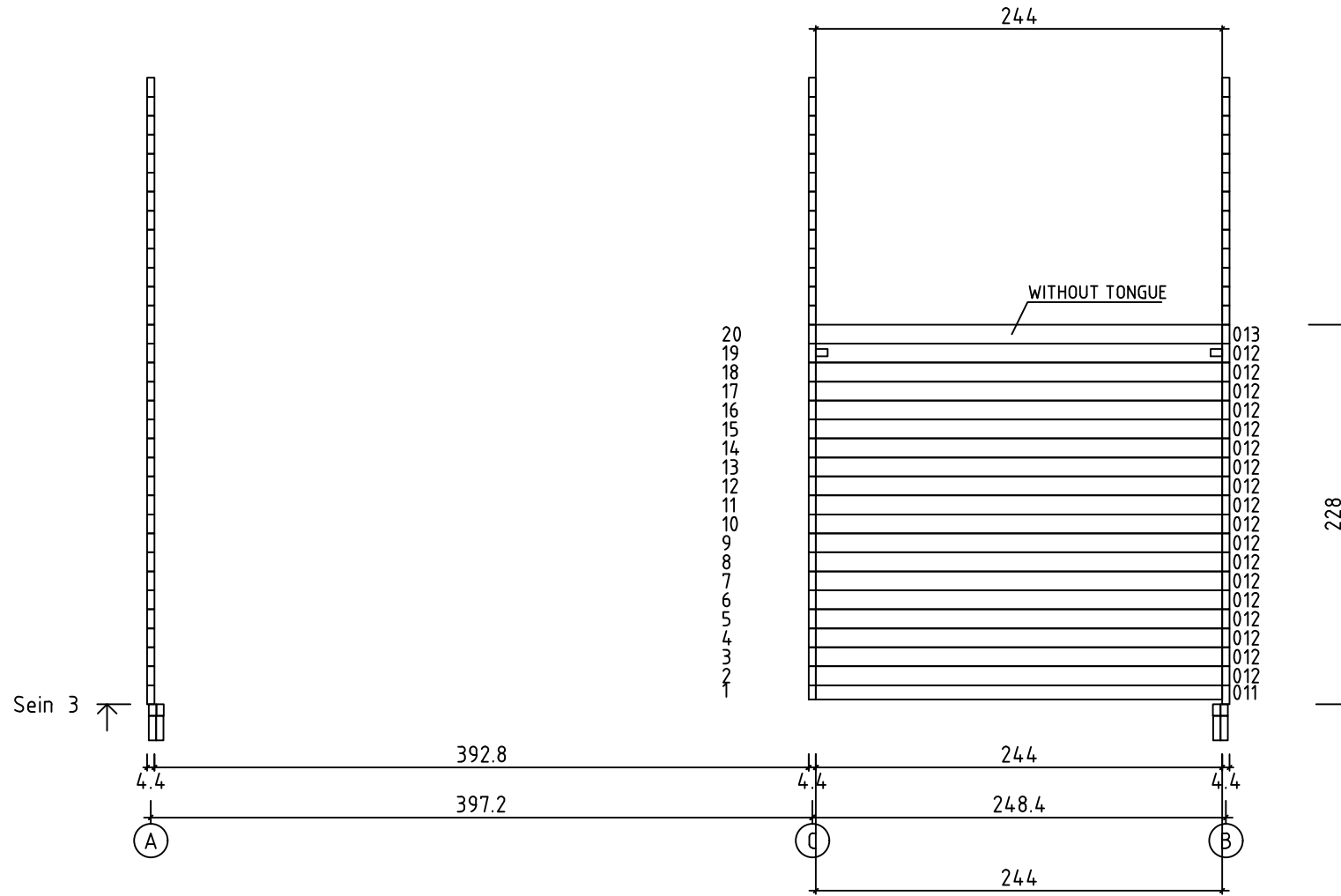

Art. Nr. 4432899

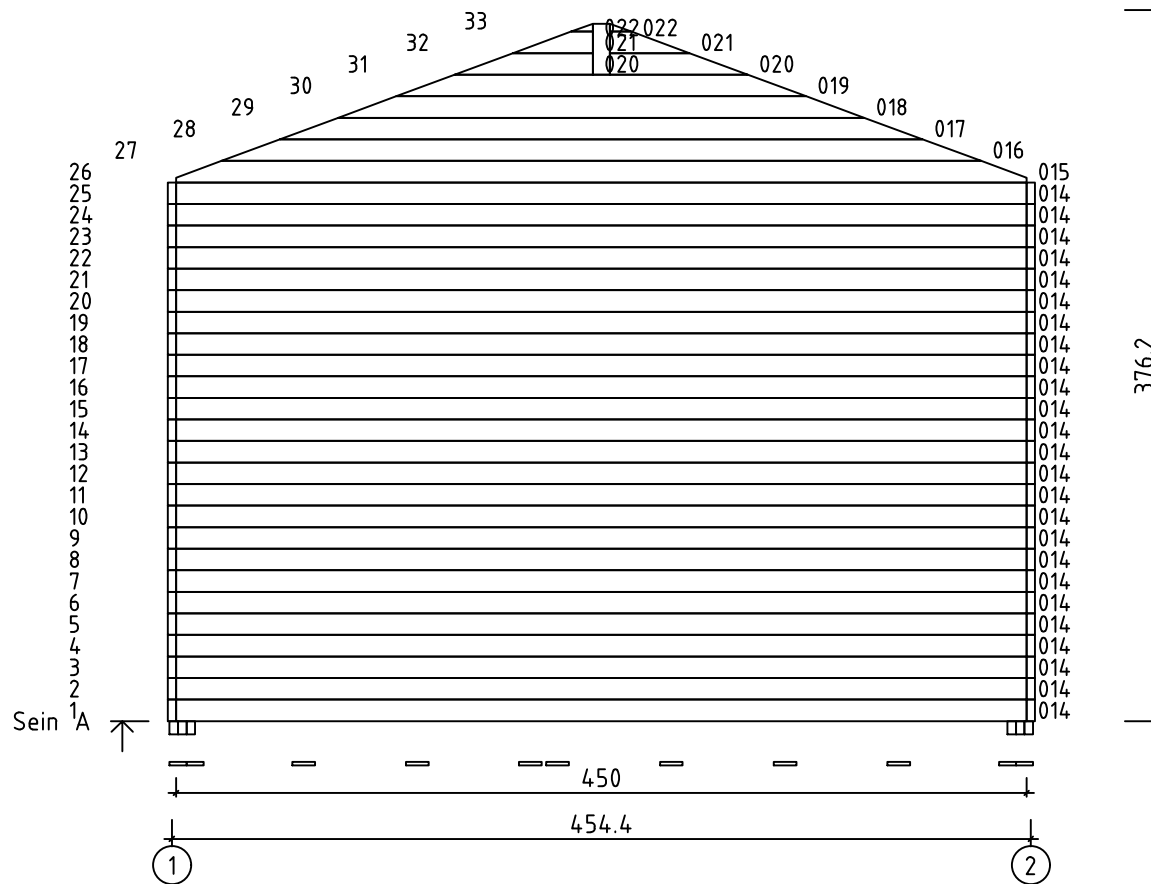

Art. Nr. 4432899

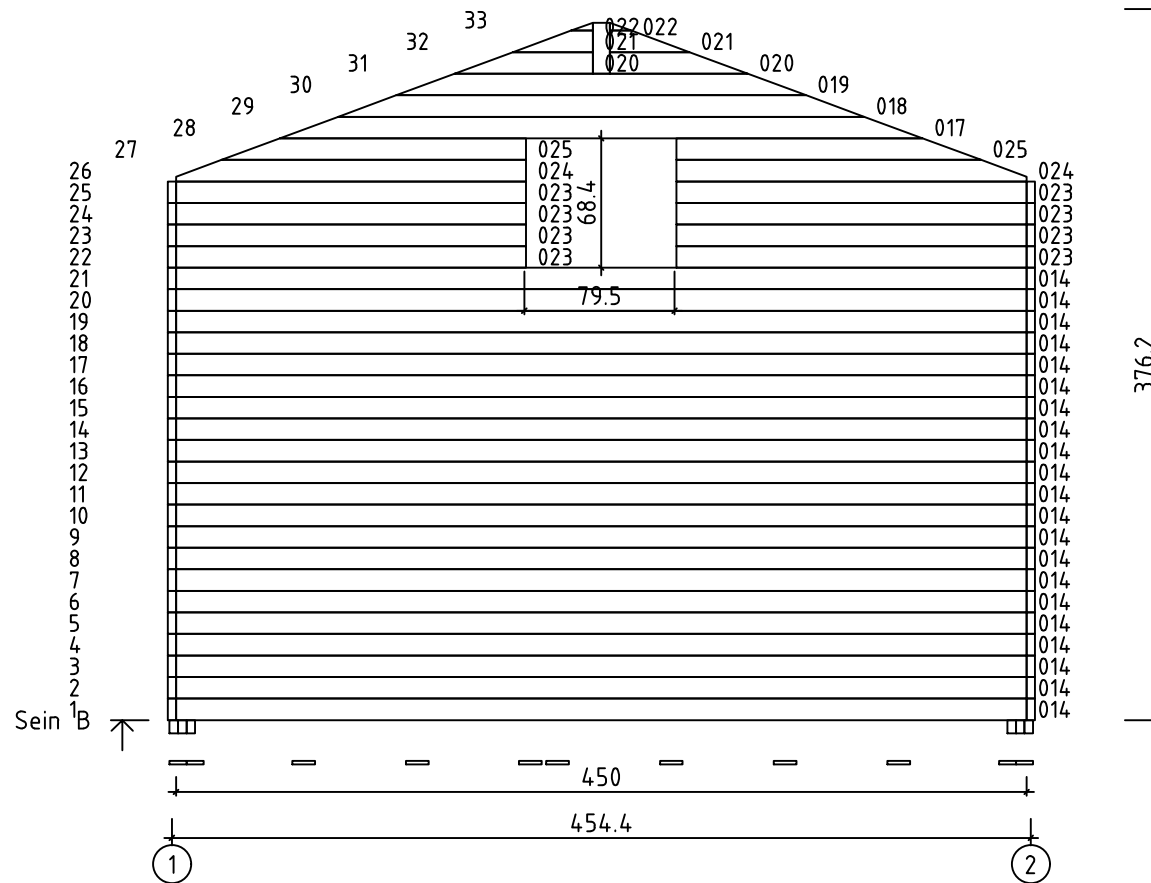

Art. Nr. 4432899

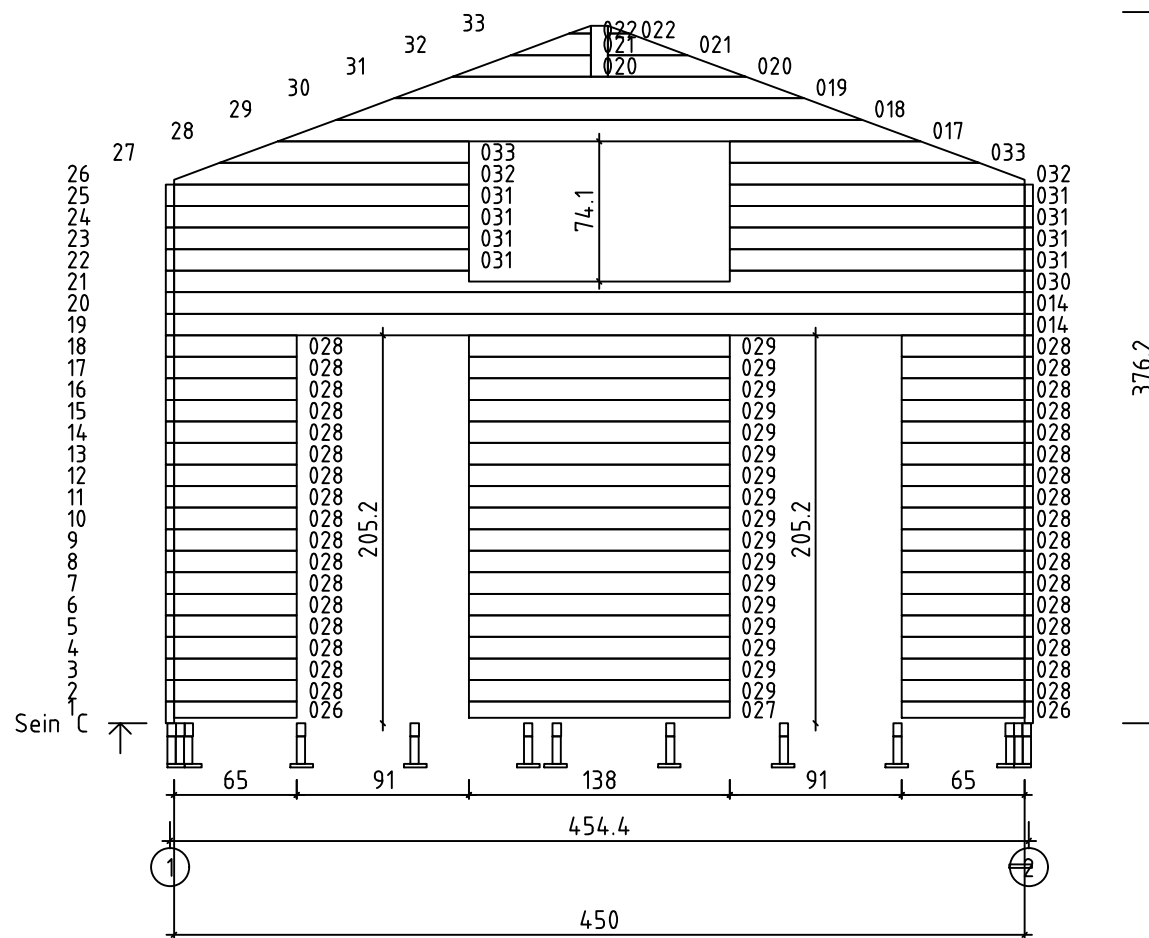

Art. Nr. 4432899

Impregnated foundation boards

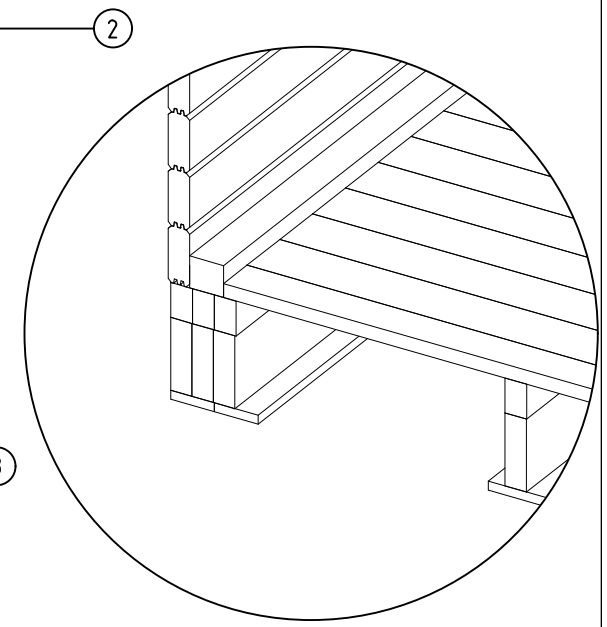
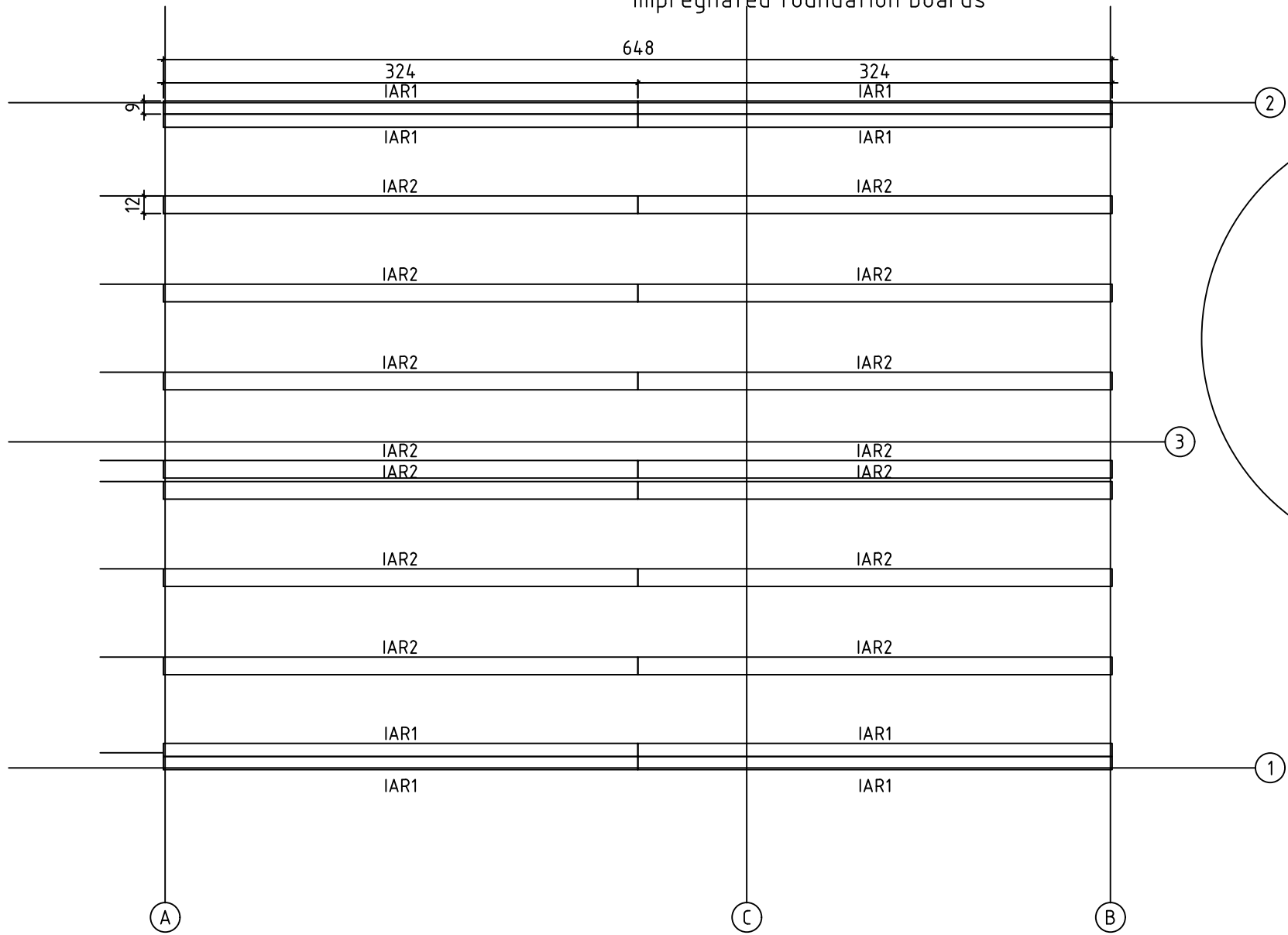

Art. Nr. 4432899

44x146 floor joists

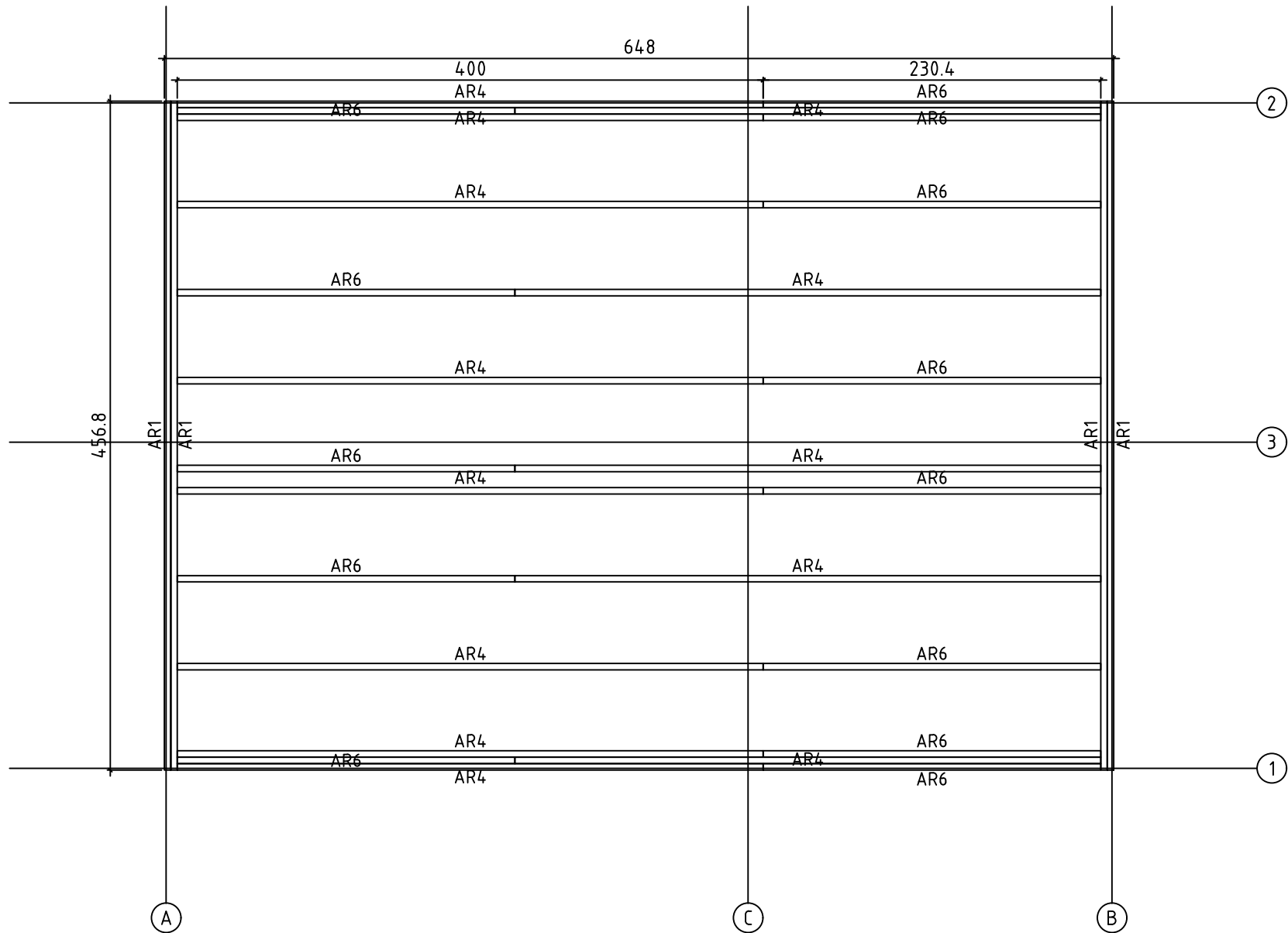

Art. Nr. 4432899

45x70 floor joists

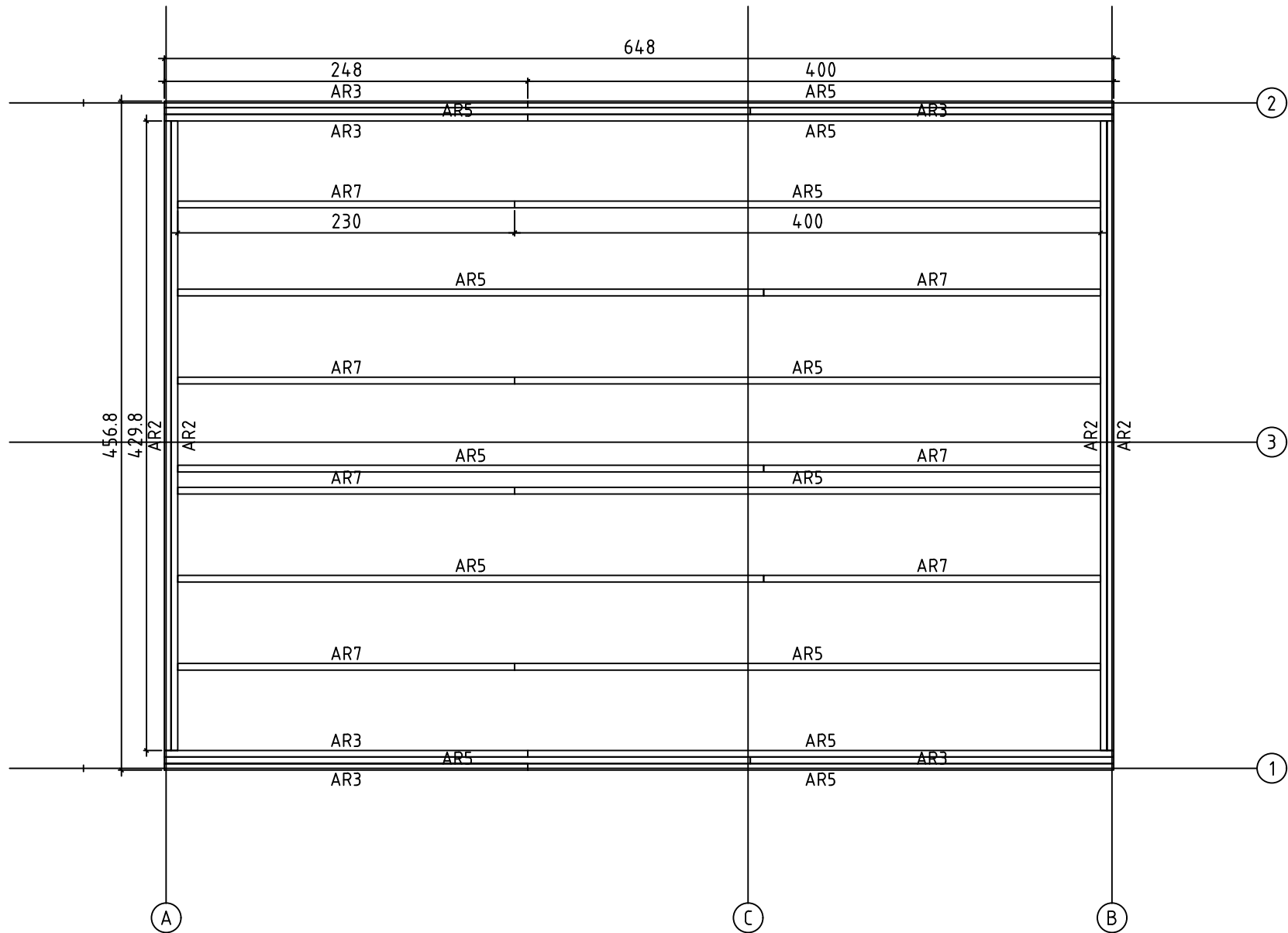

Art. Nr. 4432899

Rafters

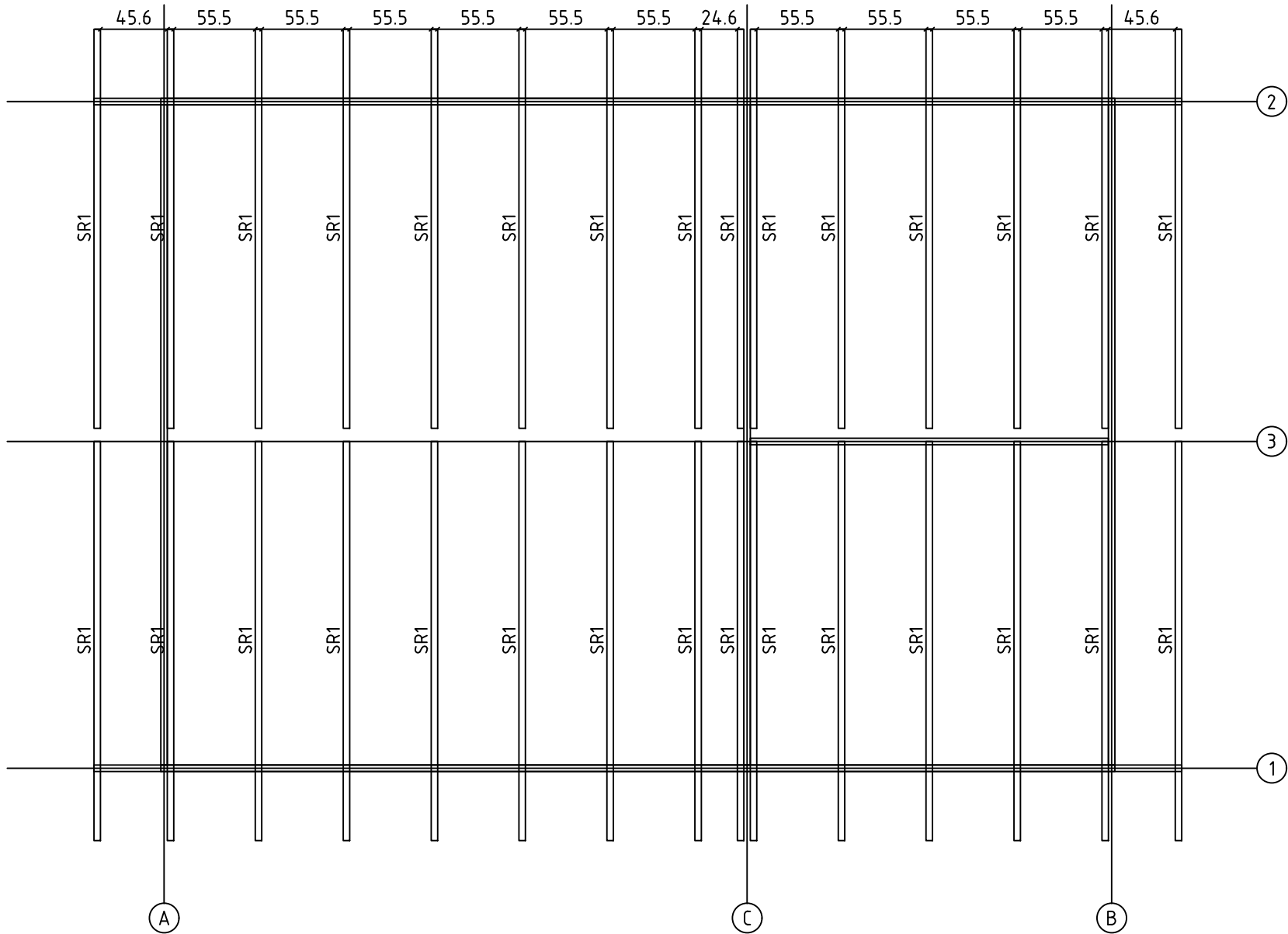

Art. Nr. 4432899

Loft beams

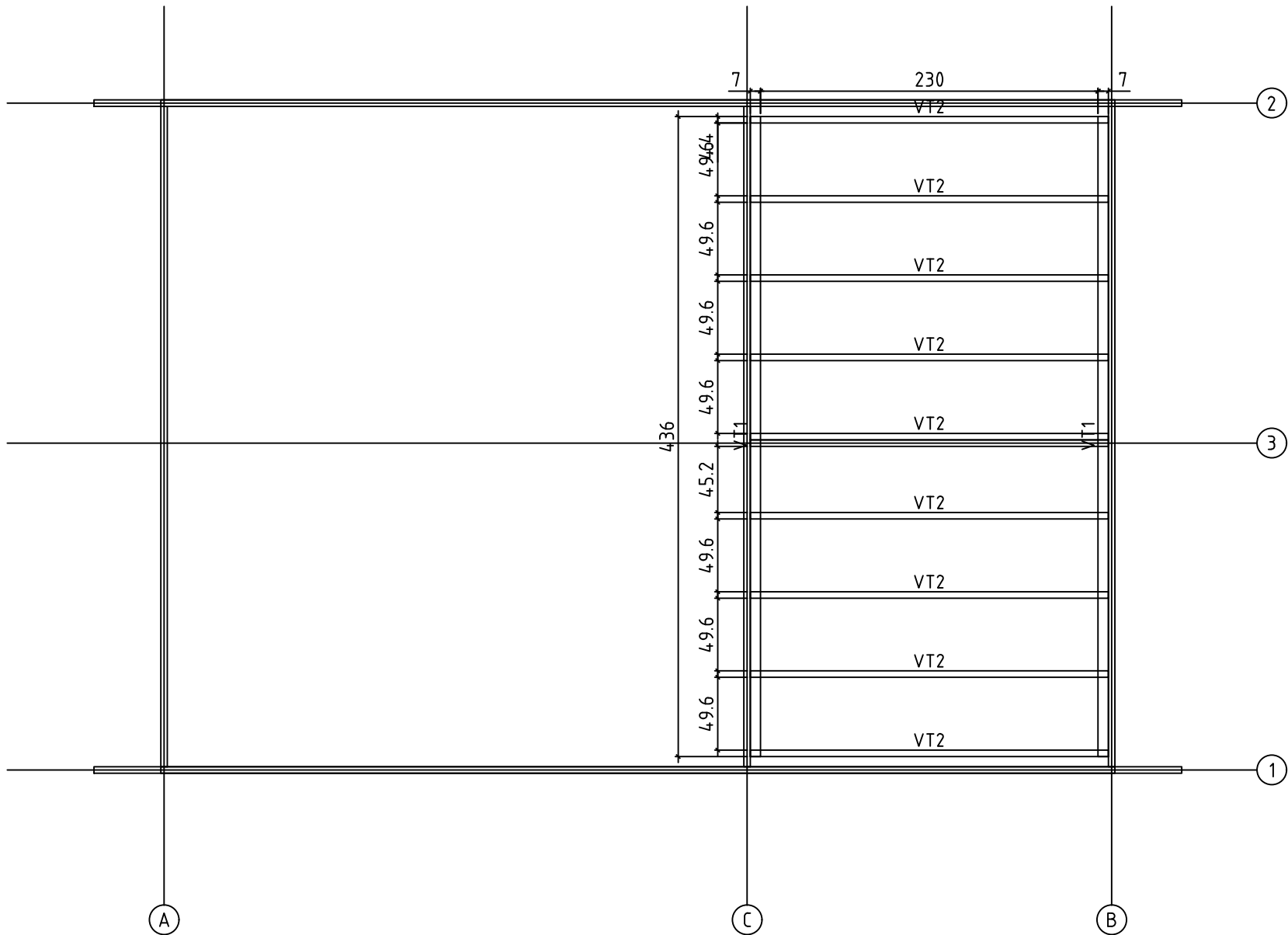

Art. Nr. 4432899



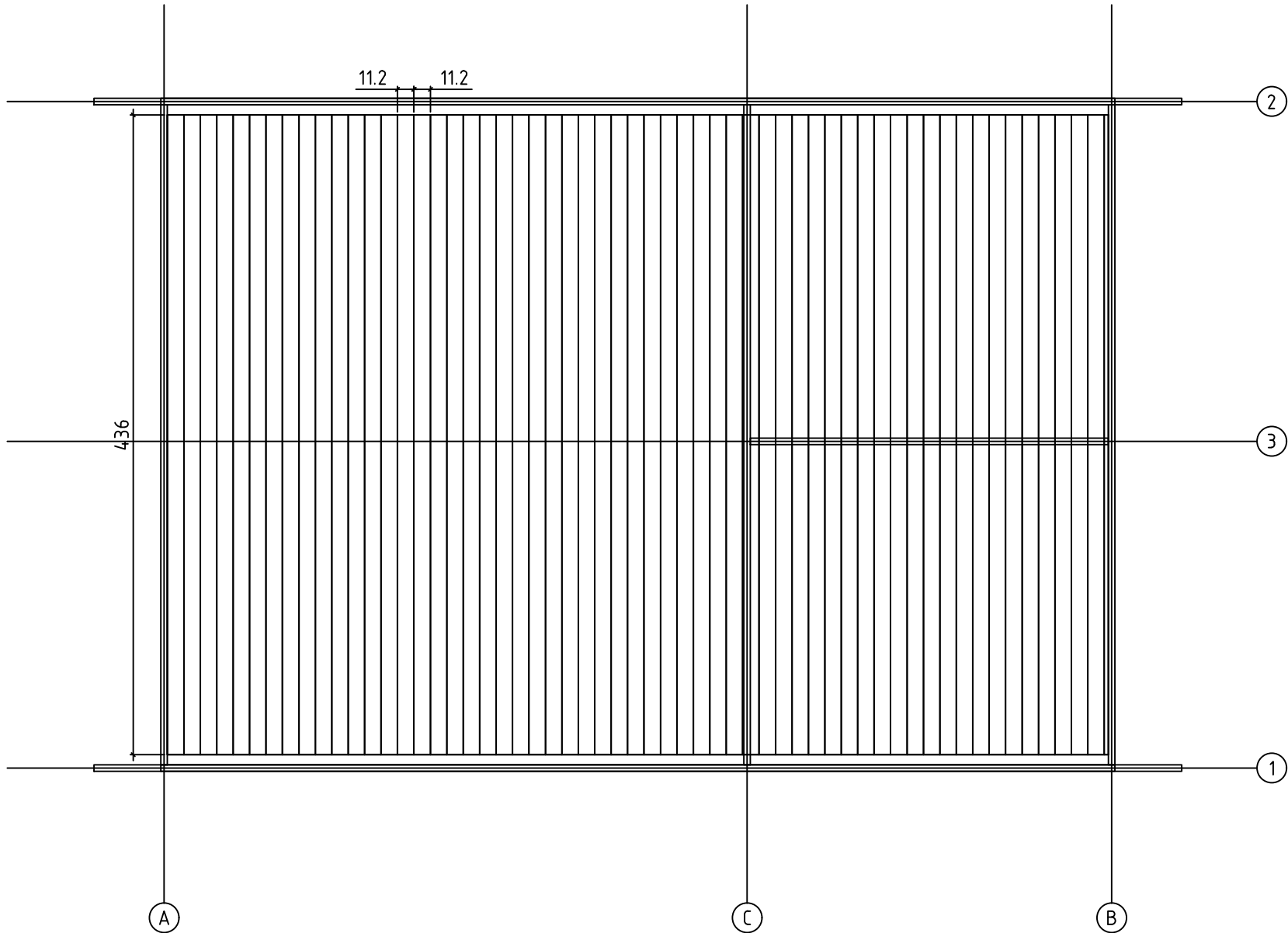





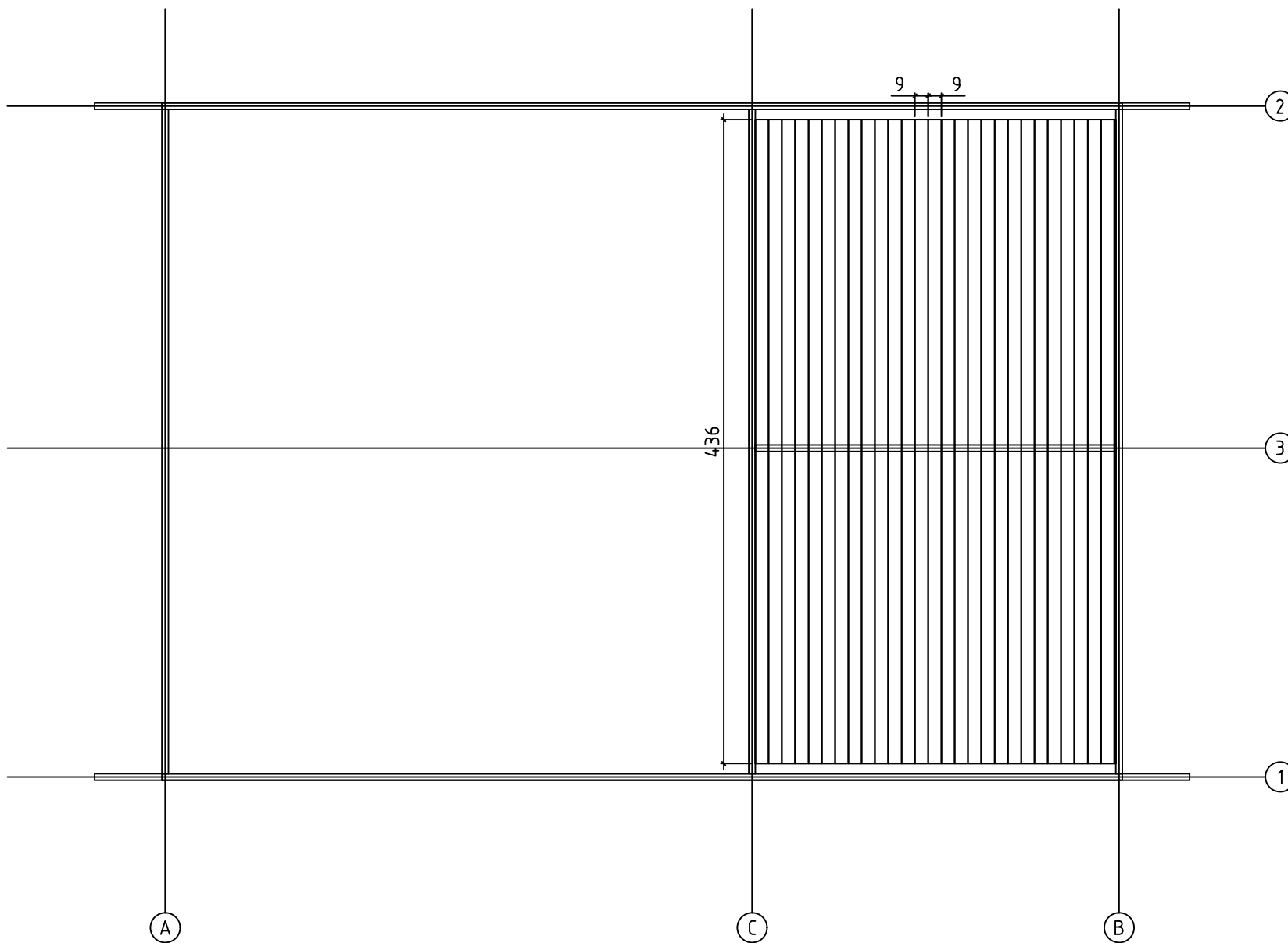

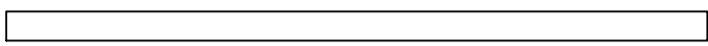
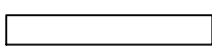
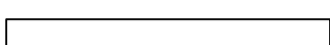
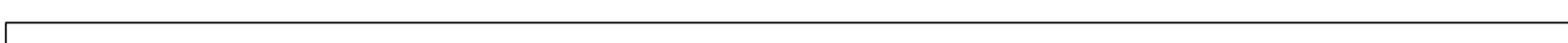
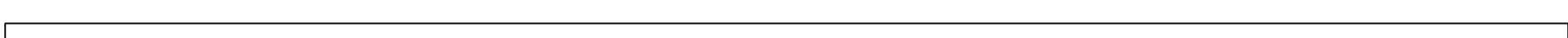
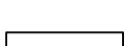
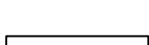



Floorboards









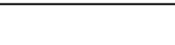
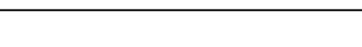
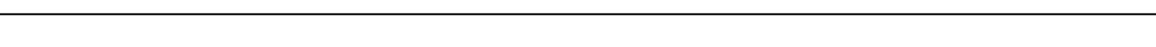

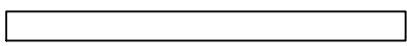
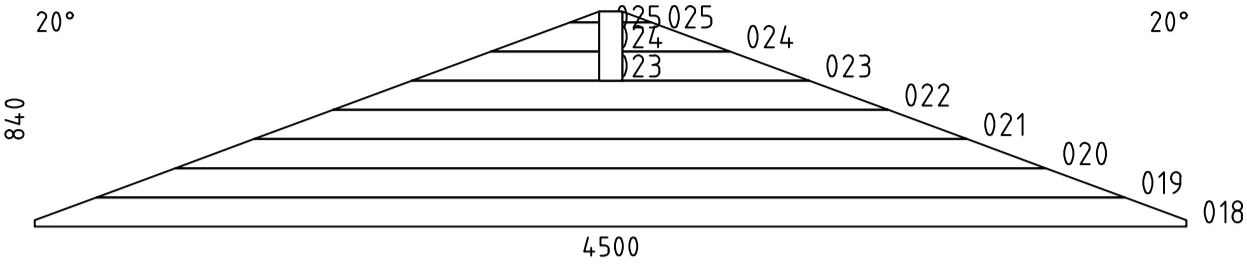
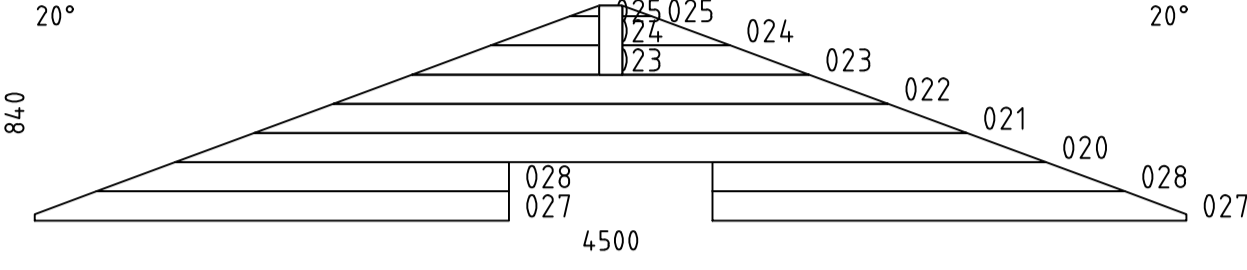
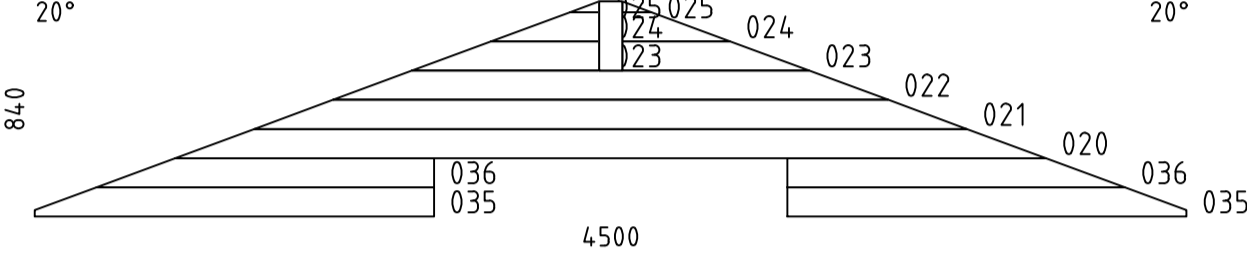
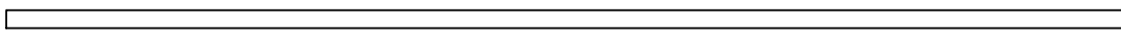
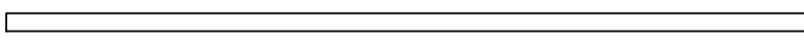
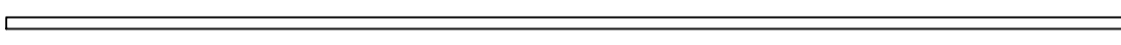
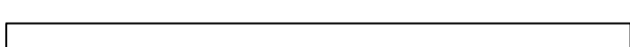

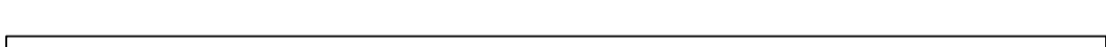





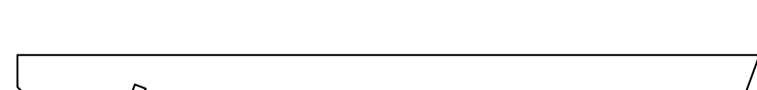
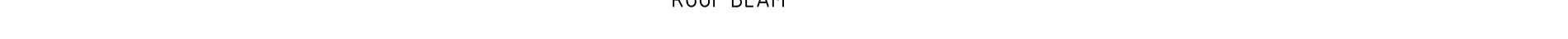



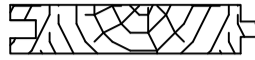

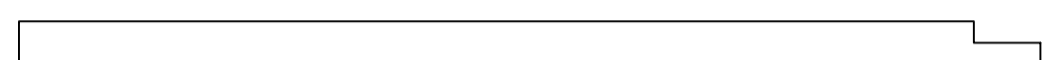



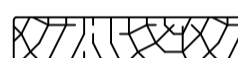

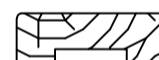
Art. Nr. 4432899

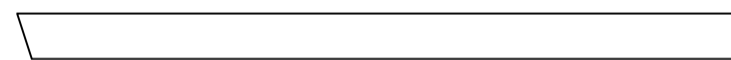
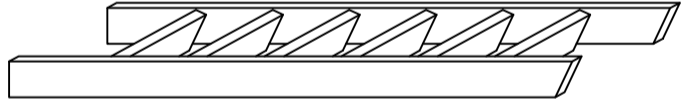
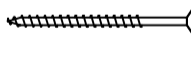
Loft floorboards



Pos	08.05.2024	PIECE LIST Art. Nr. 4432699	17/22	Q.	P (mm)	L (mm)
001				26	44x114	2740
002				18	44x114	805
003				6	44x114	1265
004				7	44x114	6500
005				4	44x114	7412
006				4	44x114	456
007				22	44x114	555
008				18	44x114	1243
009				12	44x114	3727
010				6	44x114	2097
011				15	44x114	500
012				1	44x86	2440
013				18	44x114	2440
014				1	44x114	2440
015				38	44x114	4500
016				1	44x114	4500
017				9	44x114	2630
026				8	44x114	1853
029				2	44x86	650
030				1	44x86	1380
031				34	44x114	650
032				17	44x114	1380
033				1	44x114	4500

Pos	08.05.2024	PIECE LIST Art. Nr. 4432699	18/22	Q.	P (mm)	L (mm)
034				8	44x114	1560
WA-1				1		
WB-1				1		
WC-1				1		
PT1		FLOOR FILLET		4	70x70	4360
PT2		FLOOR FILLET		6	70x70	3136
VT1		MEZZANINE FLOOR JOISTS		2	70x45	4360
VT2		MEZZANINE FLOOR JOISTS		9	44x146	2440
IAR2		FOUNDATION		14	120x18	3240
IAR1		FOUNDATION		8	90x18	3240
AR2		FOUNDATION		4	45x70	4298
AR5		FOUNDATION		13	45x70	4000
AR3		FOUNDATION		6	45x70	2480
AR7		FOUNDATION		7	45x70	2300
AR1		FOUNDATION		4	44x146	4568
AR4		FOUNDATION		13	44x146	4000
AR6		FOUNDATION		13	44x146	2304
SR1		RAFTER		30	44x170	2900
A-PR1		ROOF BEAM		1	90x270	7412
HLL-1	FLOOR BOARDS			58	112x28	4360

Pos	08.05.2024	PIECE LIST Art. Nr. 4432699		19/22	Q.	P (mm)	L (mm)
FB-1	FLOOR BOARDS				28	90x18.5	4360
RB-1	ROOF BOARDS				66	90x18.5	5093
RB-2	ROOF BOARDS				66	90x18.5	2319
RFF	ROOFING FELT FILLET				4	18x58	3050
RS1	RAILING STRIP				4	18x120	2850
RS2	RAILING STRIP				4	18x120	2850
P1	POST				2	70x70	2061
P2	POST				8	70x70	2700
TB1	EAVES BOARD				4	18x90	3517
TB2	EAVES BOARD				4	18x90	3895
UT-1	U-PROFILE				2	35x70	740
UT-2	U-PROFILE				1	35x70	1400
GL1	GABLE MOULDING				8	18x120	3050
GL2	GABLE MOULDING				4	18x140	3050
	LADDER				1		
HS8	SCREW				400	3.5x35	
HS9	SCREW				250	3.5x50	
HSx	SCREW				500	3.9x70	
HS13	SCREW				40	4x60	
HS18	SCREW				60	5x120	
HS16	SCREW				1000	5x90	
HS23	SCREW				250	6x180	
HS26	SCREW				400	5x40	

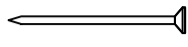
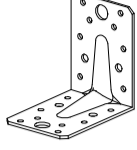
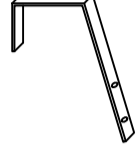
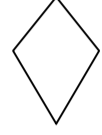
Pos	08.05.2024 PIECE LIST Art. Nr. 4432699	20/22	Q.	P (mm)	L (mm)
SH44	HAMMER BLOCK		1		
NF4	NAIL		1350	2x50	
	METAL CORNER		48	70x70x55	
	LADDER CLAMP		2	RK2616	
GS	GABLE SEGMENT		2		

Art. Nr. 4432699

U.3TV.b 900x1990

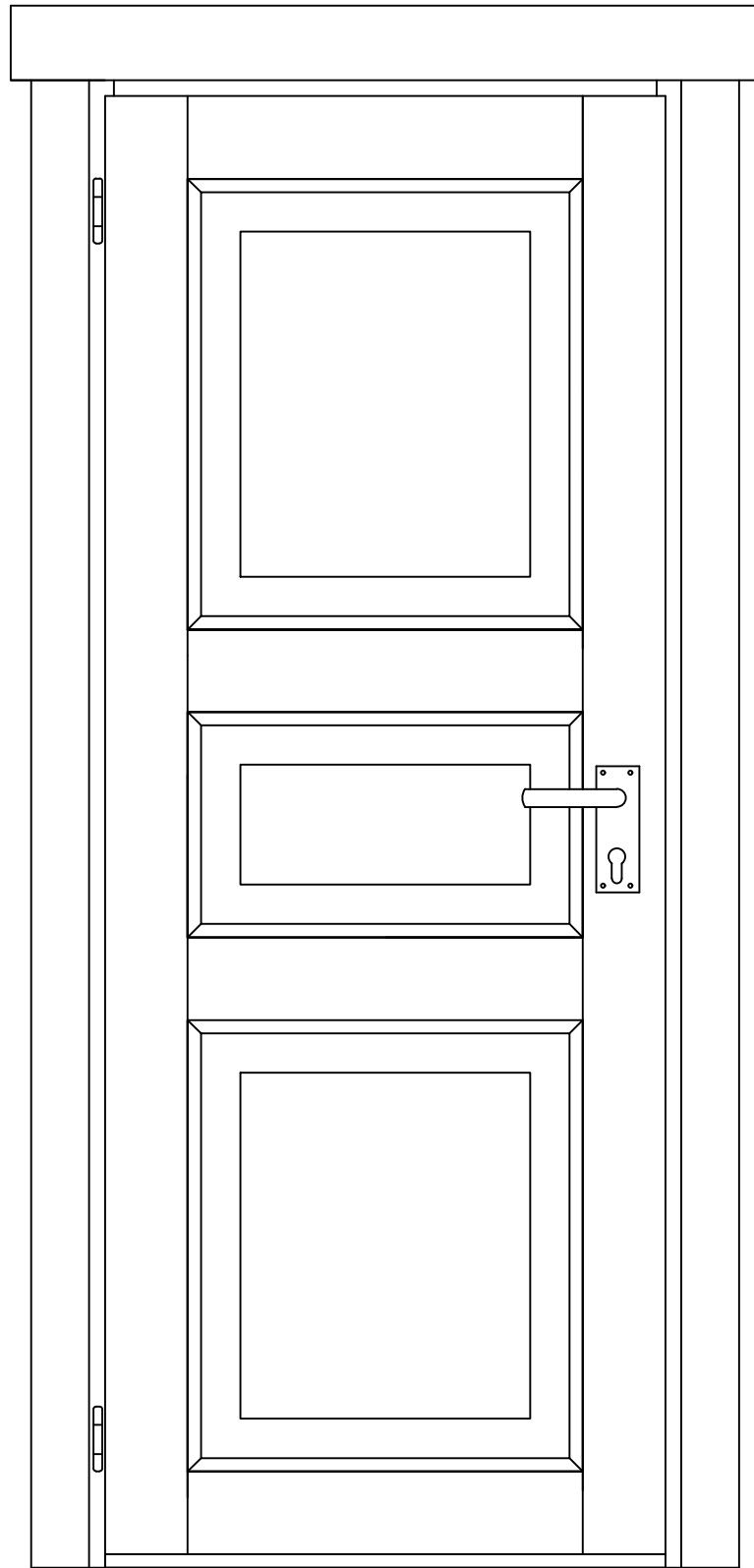

Art. Nr. 4432699

U.3TP.b 900x1990

