

VERA

P6546/44-VERA-UFD | Revision 1.0

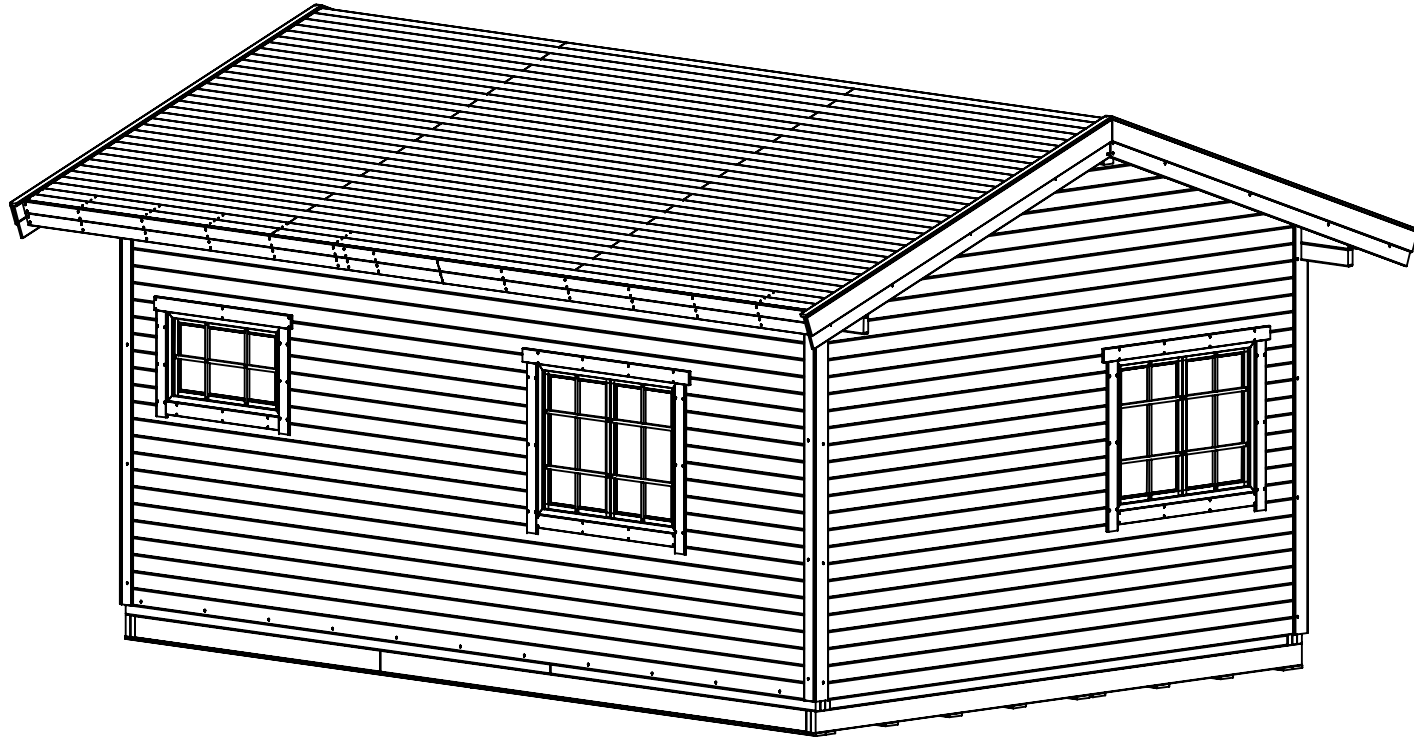

#ID

EN

Read and understand the instruction manual before starting installation.

Our products are manufactured using premium quality timber. Strict selection processes ensure that all timber is cut and planed to the correct specifications. However, wood is a natural material and will experience changes in both appearance and composition throughout its life cycle.

This means that it may develop openings in the wood structure following the grain, including gaps, apertures, cracks, and splits. These gaps are expected during drier and wetter seasons. This is not a cause for concern and will not affect the structural integrity or the product's guarantee.

Always remember:

- Pre-drill the indicated holes.
- Unpacking and assembly should be done by at least two people to avoid accidents.
- Wear gloves and safety glasses.
- Prepare a firm, level foundation before assembly.

For more information, you will find the general manual and our general terms and conditions at www.polhus.com

DE

Bitte lesen und verstehen Sie die Bedienungsanleitung vollständig, bevor Sie mit der Installation beginnen.

Unsere Produkte bestehen aus hochwertigem Holz. Durch strenge Auswahlprozesse stellen wir sicher, dass das Holz gemäß den festgelegten Spezifikationen geschnitten und gehobelt wird. Da Holz ein Naturmaterial ist, unterliegt es im Laufe der Zeit optischen und strukturellen Veränderungen.

- Entlang der Maserung können sich Risse, Spalten und Öffnungen bilden.
- Diese Veränderungen sind natürliche Reaktionen auf wechselnde Feuchtigkeits- und Klimabedingungen.
- Sie beeinträchtigen weder die strukturelle Stabilität noch die Garantie des Produkts.

Wichtige Montagehinweise:

- Bohren Sie stets die angegebenen Löcher vor.
- Das Auspacken und die Montage sollten aus Sicherheitsgründen von mindestens zwei Personen durchgeführt werden.
- Tragen Sie während der Montage geeignete Schutzausrüstung, einschließlich Handschuhen und Schutzbrille.
- Bereiten Sie vor der Montage eine stabile und ebene Grundlage vor.

Detaillierte Informationen finden Sie im allgemeinen Handbuch sowie in unseren Geschäftsbedingungen unter www.polhus.com

FR

Lisez attentivement le manuel d'instruction avant de commencer l'installation.

Nos produits sont fabriqués en bois de haute qualité, soigneusement sélectionné, coupé et raboté selon des spécifications précises. Cependant, le bois étant un matériau naturel, il évolue au fil du temps, tant dans son apparence que dans sa structure.

Des fissures, interstices et fentes peuvent apparaître le long des veines du bois en fonction des variations saisonnières d'humidité. Ces phénomènes sont normaux et n'affectent ni la solidité du produit ni sa garantie.

Consignes importantes :

- Percez toujours les trous prévus à l'avance.
- Le déballage et le montage doivent être réalisés par au moins deux personnes pour éviter tout risque d'accident.
- Portez des gants et des lunettes de protection.
- Assurez-vous de préparer une base stable et parfaitement nivelée avant de commencer l'assemblage.

Pour plus d'informations, consultez le manuel général ainsi que nos conditions générales sur la page web de votre pays : www.polhus.com

NL

Lees en begrijp de handleiding voordat u met de installatie begint.

Alle producten worden vervaardigd van hoogwaardig hout. Strenge selectieprocessen zorgen ervoor dat al het hout volgens de juiste specificaties wordt gezaagd en geschaafd. Hout is echter een natuurlijk materiaal en zal gedurende zijn levenscyclus veranderingen ondergaan in zowel uiterlijk als samenstelling.

Dit betekent dat er openingen kunnen ontstaan in de houtstructuur langs de nerf, zoals spleten, barsten en scheuren. Deze veranderingen zijn normaal tijdens zowel droge als vochtige seizoenen. Dit is geen reden tot bezorgdheid en heeft geen invloed op de structurele integriteit of de garantie van het product.

Onthoud altijd:

- Boor altijd de aangegeven gaten voor.
- Het uitpakken en monteren dient door minimaal twee personen te worden uitgevoerd om ongelukken te voorkomen.
- Draag handschoenen en een veiligheidsbril.
- Zorg voor een stevige en vlakke ondergrond voordat u met de montage begint.

Voor meer informatie vindt u de algemene handleiding en onze algemene voorwaarden op de website: www.polhus.com

PL

Przeczytaj i upewnij się, że rozumiesz instrukcję przed rozpoczęciem instalacji.

Nasze produkty powstają z doskonałej jakości materiałów. Surowe procesy kontroli produkcji gwarantują cięcie i heblowanie zgodne z najwyższymi standardami. Należy jednak pamiętać, że drewno to naturalny surowiec, który stopniowo zmienia zarówno swój wygląd, jak i strukturę.

Wraz z upływem czasu na powierzchni desek i belek mogą pojawić się szczeliny, pęknięcia i rysy. Zmiany te są naturalne i zależne od natężenia wilgoci w różnych porach roku. Nie stanowią one powodu do niepokoju i nie wpływają na integralność konstrukcyjną ani gwarancję produktu.

Pamiętaj o:

- wstępnym nawierceniu wszystkich wskazanych otworów;
- rozpakowaniu i montażu elementów przez co najmniej dwie osoby, aby uniknąć wypadków;
- noszeniu rękawic i okularów ochronnych;
- przygotowaniu solidnego i równego fundamentu przed rozpoczęciem montażu.

Więcej informacji, w tym ogólną instrukcję montażu oraz regulamin, znajdziesz na stronie internetowej www.polhus.com

SE

Läs och förstå manualen innan du påbörjar installationen.

Alla våra produkter tillverkas av högkvalitativt trä. Strikta urvalsprocesser säkerställer att allt trä kapas och hyvlas utefter givna specifikationer. Trä är dock ett naturligt material och kommer att förändras både i utseende och sammansättning under sin livscykel.

Detta innebär att träet kan utveckla sprickor och öppningar längs fibrerna, inklusive glipor, springor och sprickbildning. Dessa variationer är normala under både torra och fuktiga perioder. Detta är inte något att oroa sig för och påverkar varken den strukturella hållfastheten eller produktens garanti.

Kom ihåg att:

- Förborra alltid de angivna hålen.
- Uppackning och montering bör utföras av minst två personer för att undvika olyckor.
- Använd handskar och skyddsglasögon.
- Förbered en stabil och jämn grund innan montering.

För mer information hittar du den allmänna manualen och våra allmänna villkor på www.polhus.com

NO

Les og forstå bruksanvisningen før du starter installasjonen.

Alle produkter er laget av trevirke av høy kvalitet. Strenge utvalgsriterier sikrer at alt treverk blir kuttet og høvlet i henhold til riktige spesifikasjoner. Tre er imidlertid et naturlig materiale og vil endre både utseende og sammensetning gjennom sin livssyklus.

Dette betyr at treet kan utvikle åpninger i strukturen langs årringene, inkludert sprekker, glipper og revner. Disse variasjonene er normale i både tørre og fuktige perioder. Dette er ikke noe å bekymre seg for og vil ikke påvirke den strukturelle integriteten eller produktets garanti.

Husk å:

- Forbor alltid de angitte hullene.
- Oppakking og montering bør utføres av minst to personer for å unngå ulykker.
- Bruk handsker og vernebriller.
- Forbered et solid og jevnt fundament før montering.

For mer informasjon finner du den generelle manualen og våre generelle vilkår på www.polhus.com

DK

Læs og forstå brugsanvisningen, før du påbegynder installationen.

Alle produkter er fremstillet af træ af høj kvalitet. Strenge udvælgelsesprocesser sikrer, at alt træ skæres og høvles i henhold til de korrekte specifikationer. Træ er dog et naturligt materiale og vil ændre både udseende og sammensætning gennem sin livscyklus.

Dette betyder, at træet kan udvikle åbninger i strukturen langs årringene, herunder sprækker, revner og mellemrum. Disse variationer er normale i både tørre og fugtige perioder. Dette er ikke grund til bekymring og påvirker hverken den strukturelle integritet eller produktets garanti.

Husk at:

- Forbor altid de angivne huller.
- Udpakning og montering bør udføres af mindst to personer for at undgå ulykker.
- Brug handsker og sikkerhedsbriller.
- Forbered et fast og jævnt fundament inden montering.

For mere information finder du den generelle manual og vores generelle vilkår på www.polhus.com

Lue ja ymmärrä käyttöohje ennen asennuksen aloittamista.

Kaikki tuotteet valmistetaan korkealaatuisesta puusta. Tiukat valintaprosessit varmistavat, että kaikki puu leikataan ja höylätään oikeiden spesifikaatioiden mukaisesti. Puu on kuitenkin luonnonmateriaali ja sen ulkonäkö sekä koostumus muuttuvat sen elinkaaren aikana.

Tämä tarkoittaa, että puuhun voi muodostua rakenteellisia avautumia syiden suuntaisesti, kuten rakoja, halkeamia ja uurteita. Nämä muutokset ovat normaaleja sekä kuivina että kosteina kausina. Tämä ei ole syy huoleen, eikä se vaikuta rakenteelliseen kestävyYTEEN tai tuotteen takuuseen.



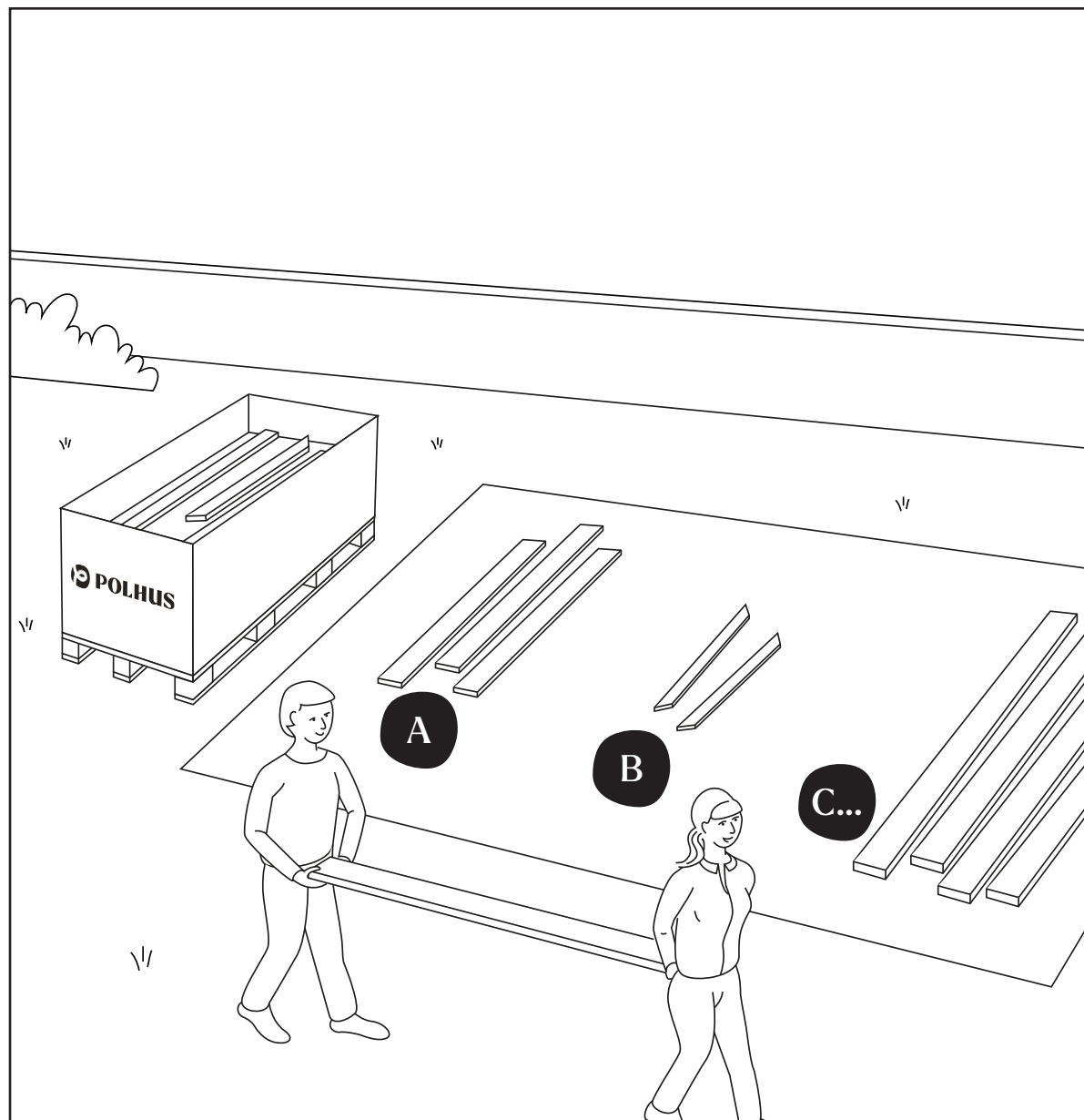
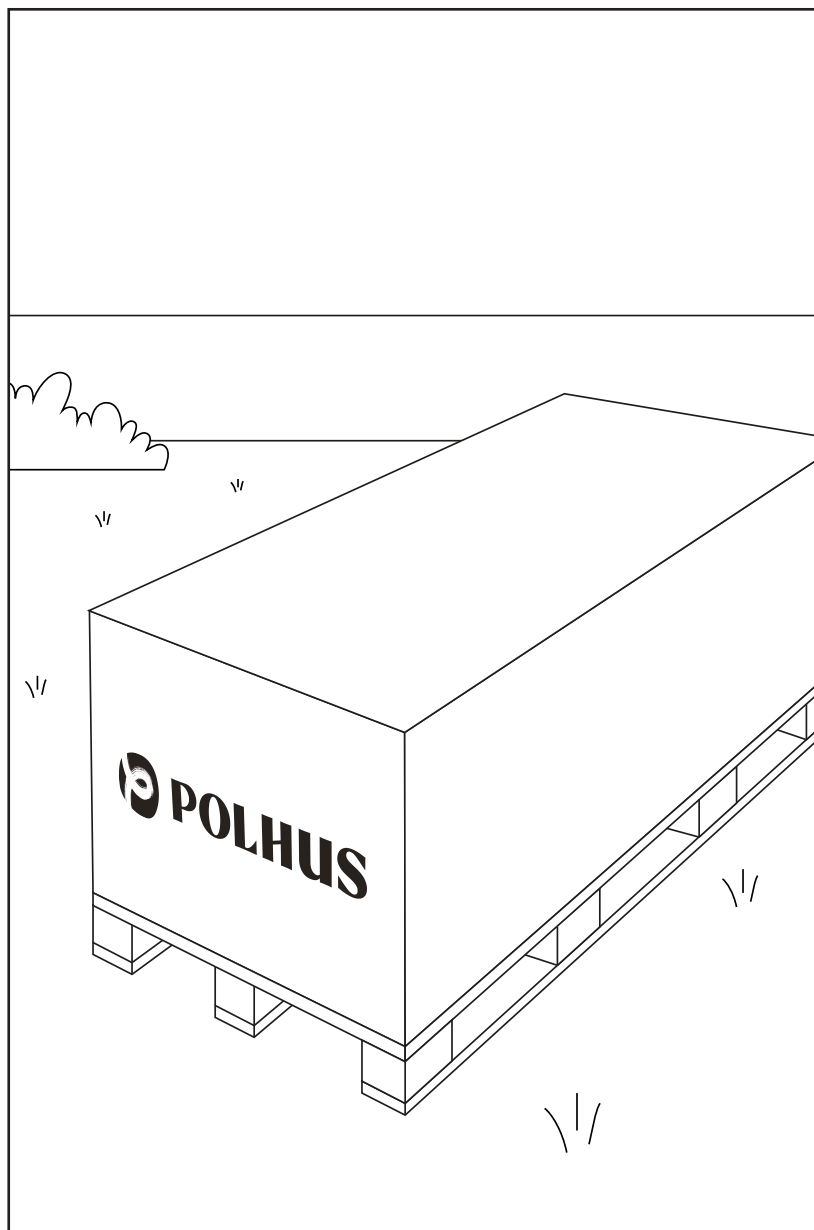

Muista että:

- Esiporaa aina merkityt reiät.
- Pakkauksen purkaminen ja kokoaminen tulisi suorittaa vähintään kahden henkilön voimin tapaturmien välttämiseksi.
- Käytä käsineitä ja suojalaseja.
- Valmisteleva ja tasainen perusta ennen kokoamista.



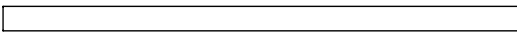
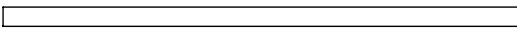

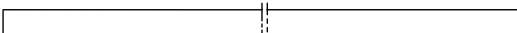
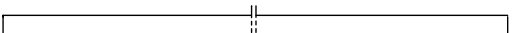
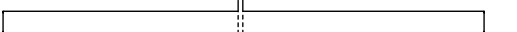
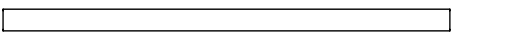
Lisätietoja löydät yleisestä käyttöoppaasta ja yleisistä ehdoistamme kunkin maan verkkosivustolta osoitteessa www.polhus.com





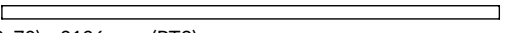



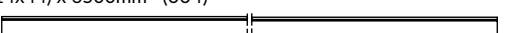

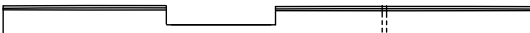





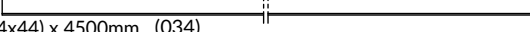

A

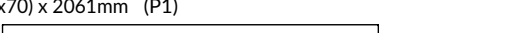
- W1 
 x14 (120x18) x 3240mm (IAR2)
- W2 
 x8 (90x18) x 3240mm (IAR1)
- W3 
 x13 (146x44) x 4000mm (AR4)
- W4 
 x13 (146x44) x 2304mm (AR6)
- W5 
 x4 (146x44) x 4568mm (AR1)
- W6 
 x4 (70x45) x 4298mm (AR2)
- W7 
 x13 (70x45) x 4000mm (AR5)
- W8 
 x6 (70x45) x 2480mm (AR3)
- W9 
 x7 (70x45) x 2300mm (AR7)

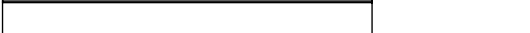
B

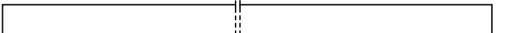
- W10 
 x4 (70x70) x 4360mm (PT1)
- W11 
 x4 (70x70) x 3136mm (PT2)
- W12 
 x26 (114x44) x 2740mm (001)
- W13 
 x18 (114x44) x 805mm (002)
- W14 
 x6 (114x44) x 1265mm (003)
- W15 
 x16 (114x44) x 6500mm (004)
- W16 
 x4 (114x44) x 7412mm (005)

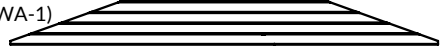

- W17 
 x15 (114x44) x 500mm (012)
- W18 
 x1 (114x44) x 6500mm (008)
- W19 
 x9 (114x44) x 1323mm (009)
- W20 
 x3 (114x44) x 3807mm (010)
- W21 
 x38 (114x44) x 4500mm (016)
- W22 
 x1 (114x44) x 4500mm (017)
- W23 
 x8 (114x44) x 1853mm (027)
- W24 
 x2 (86x44) x 650mm (030)
- W25 
 x1 (86x44) x 1380mm (031)
- W26 
 x1 (114x44) x 4500mm (034)
- W27 
 x8 (114x44) x 1560mm (035)
- W28 
 x1 (70x70) x 2061mm (P1)
- W29 
 x8 (70x70) x 2700mm (P2)
- W30 
 x34 (114x44) x 650mm (032)
- W31 
 x17 (114x44) x 1380mm (033)
- W32 
 x9 (114x44) x 2630mm (018)
- W33 
 x6 (114x44) x 2177mm (011)
- W34 
 x1 (112x28) x 4360mm (HLL-1)

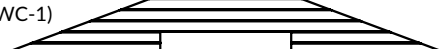
- W35 (WA-1) 
 x1



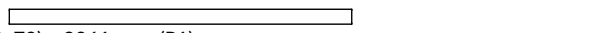
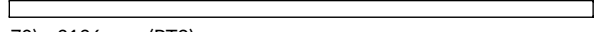

- W36 (WC-1) 
 x1

- W37 (WB-1) 
 x1

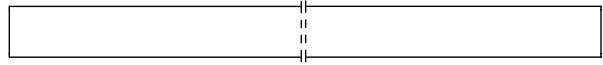

C

- W38 
 x2 (70x45) x 4360mm (VT1)
- W39 
 x5 (146x44) x 2440mm (VT2)
- W28 
 x1 (70x70) x 2061mm (P1)
- W11 
 x2 (70x70) x 3136mm (PT2)

D

- W40 
 x1 (270x90) x 7412mm (A-PR1)
- W41 
 x30 (170x44) x 2900mm (SR1)
-  x48
- W42 
 x4 (114x44) x 456mm (006)
- W43 
 x22 (114x44) x 555mm (007)

E

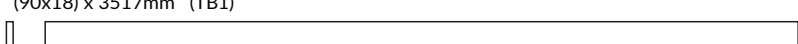
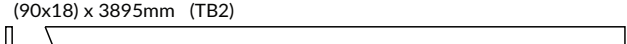
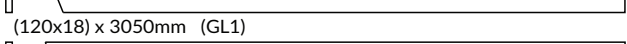
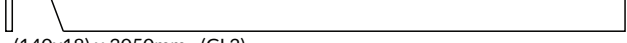
- W44
x66

(90x18.5) x 5093mm (RB-1)
- W45
x66

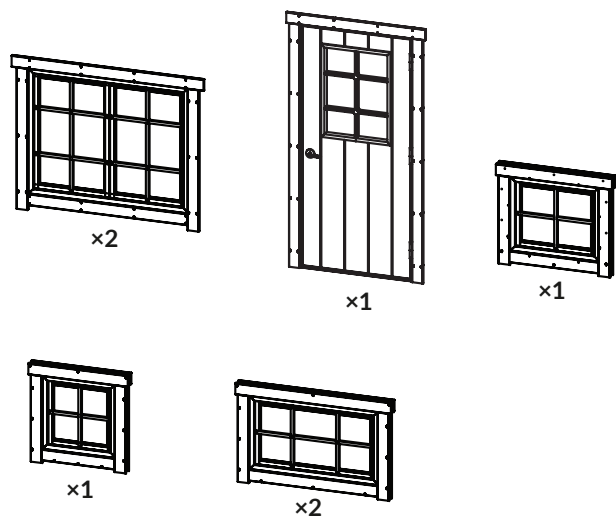
(90x18.5) x 2319mm (RB-2)
- W46
x4

(90x18) x 3517mm (TB1)
- W47
x4

(90x18) x 3895mm (TB2)
- W48
x8

(120x18) x 3050mm (GL1)
- W49
x4

(140x18) x 3050mm (GL2)
- W50
x4

(58x18) x 3050mm (RFF)



F



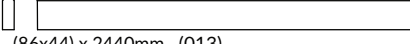

G

- W34
x57

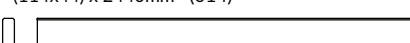
(112x28) x 4360mm (HLL-1)

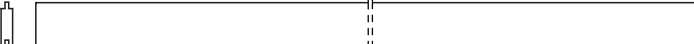

H

- W51
x1

(86x44) x 2440mm (O13)
- W52
x18

(114x44) x 2440mm (O14)
- W53
x1

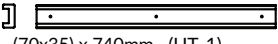
(114x44) x 2440mm (O15)

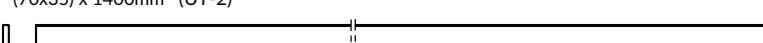
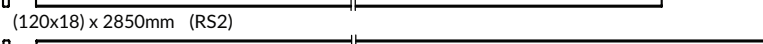
I

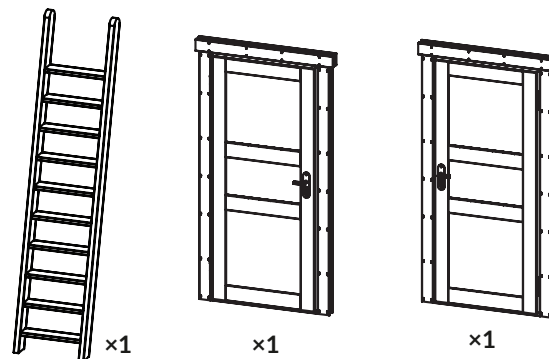
- W54
x28

(90x18.5) x 4360mm (FB-1)
- W39
x4

(146x44) x 2440mm (VT2)

J

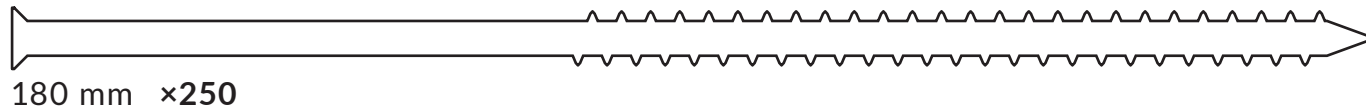
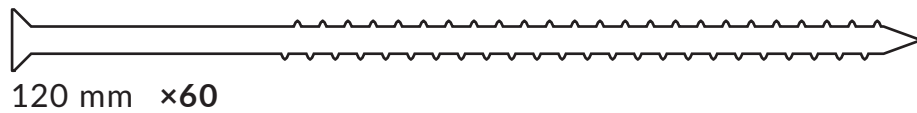
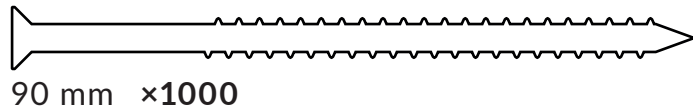
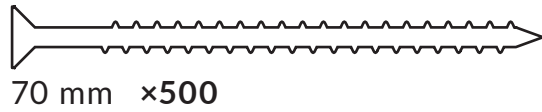
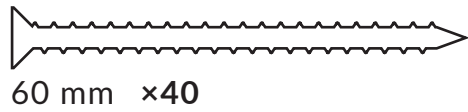
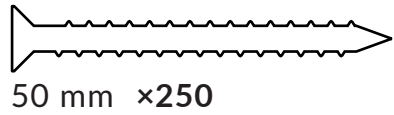
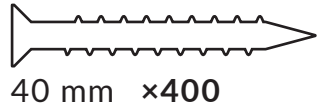
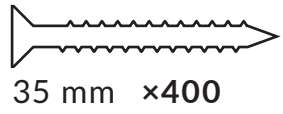
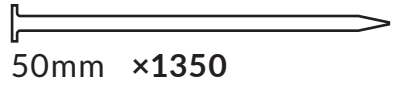
- W55
x2

(70x35) x 740mm (UT-1)
- W56
x1

(70x35) x 1400mm (UT-2)
- W57
x4

(120x18) x 2850mm (RS2)
- W58
x4

(120x18) x 2850mm (RS1)





1:1



=

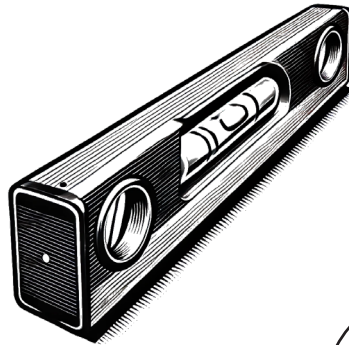
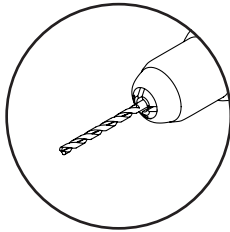

=

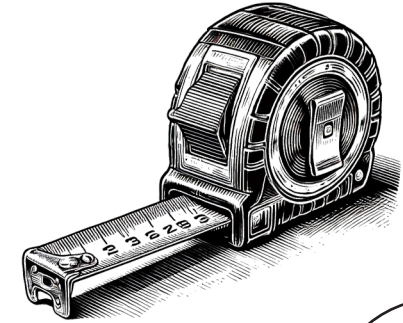
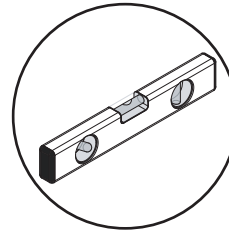

=

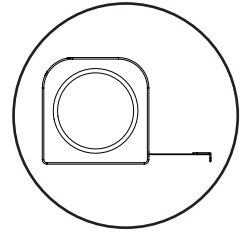

=

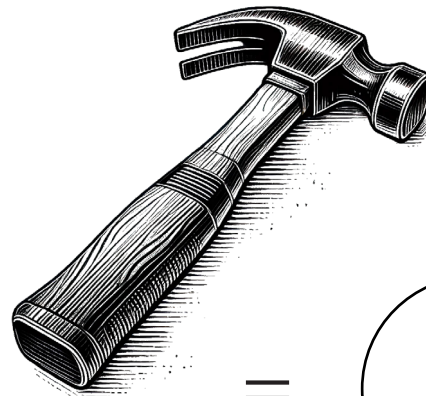
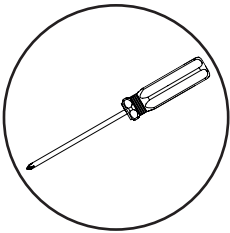

=

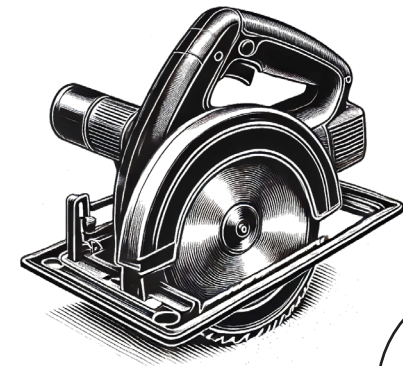
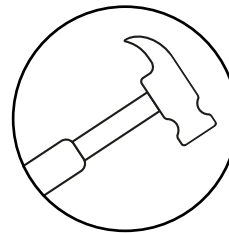

=

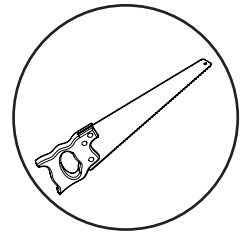

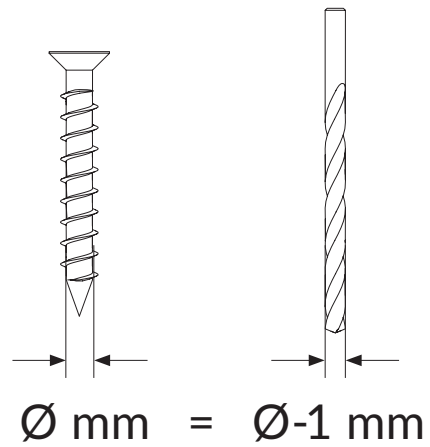
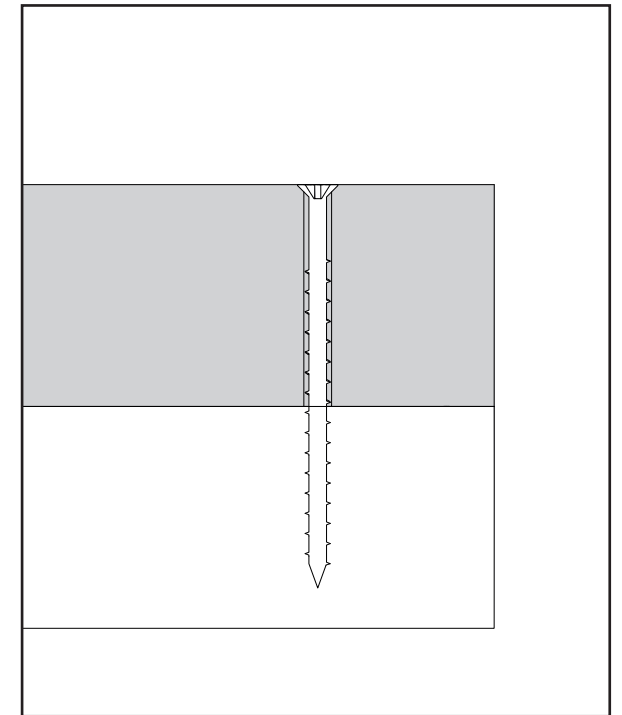
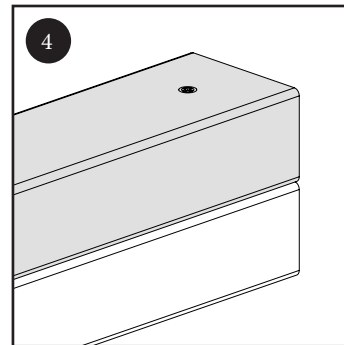
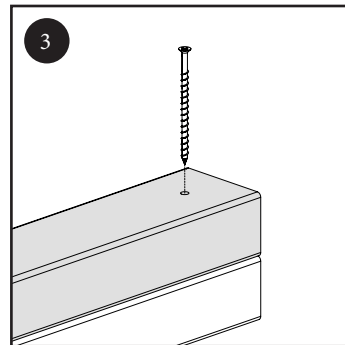
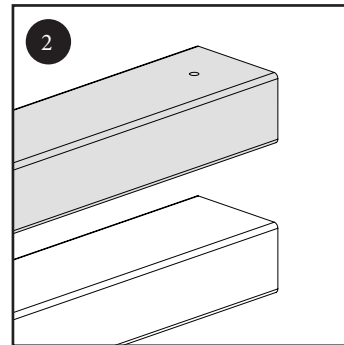
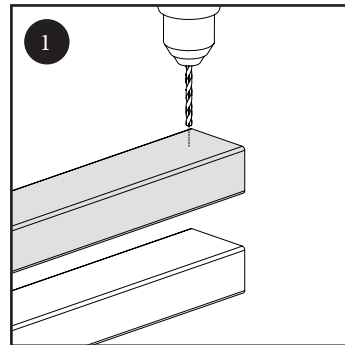
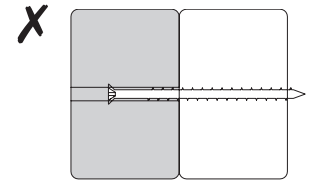
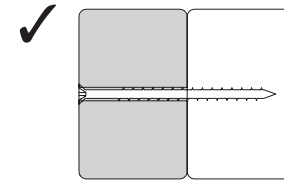
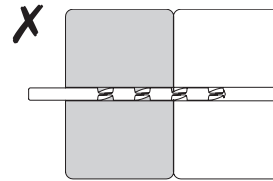
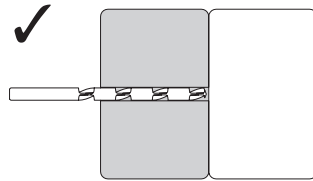
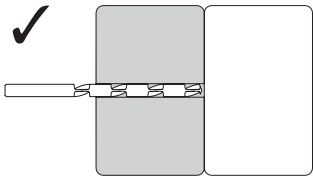
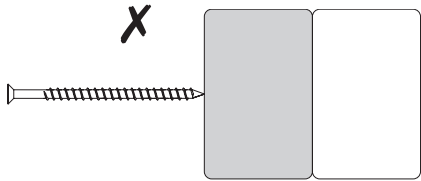

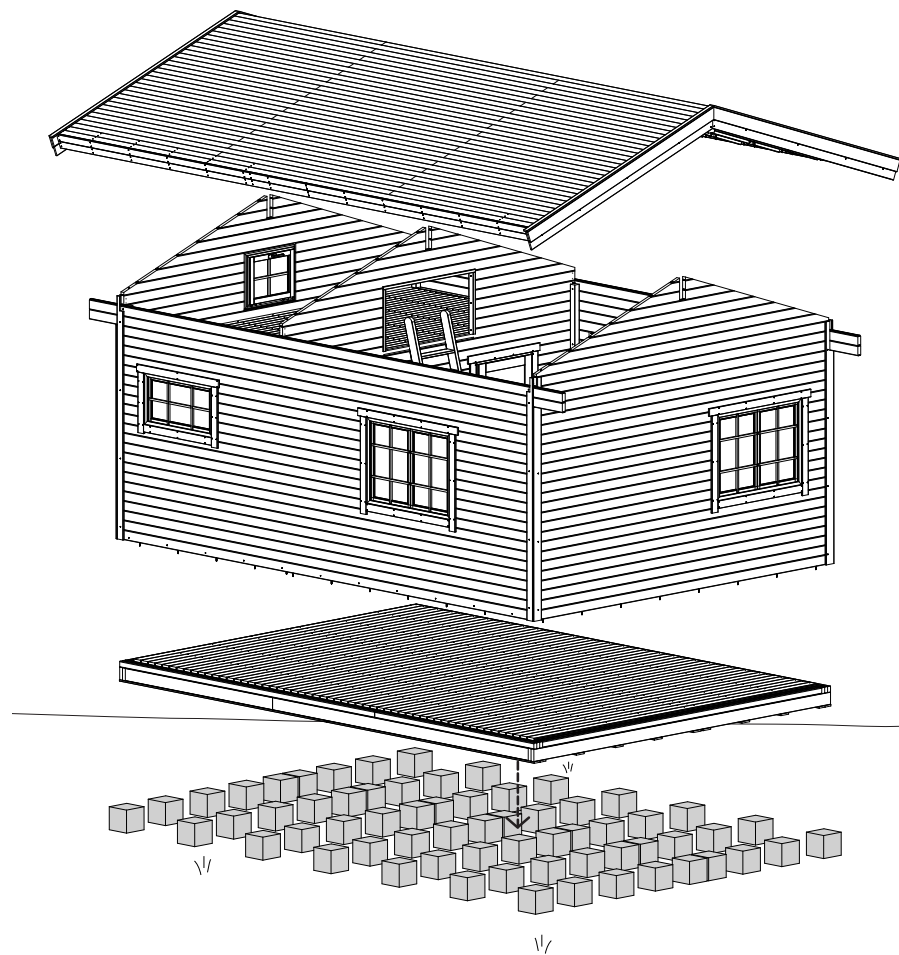
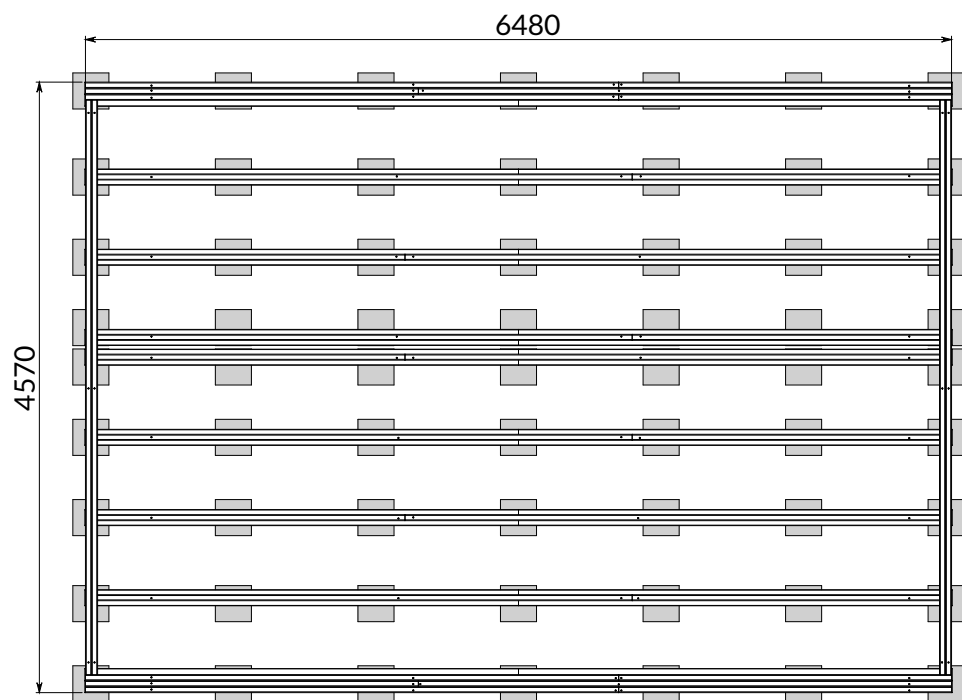

V-1

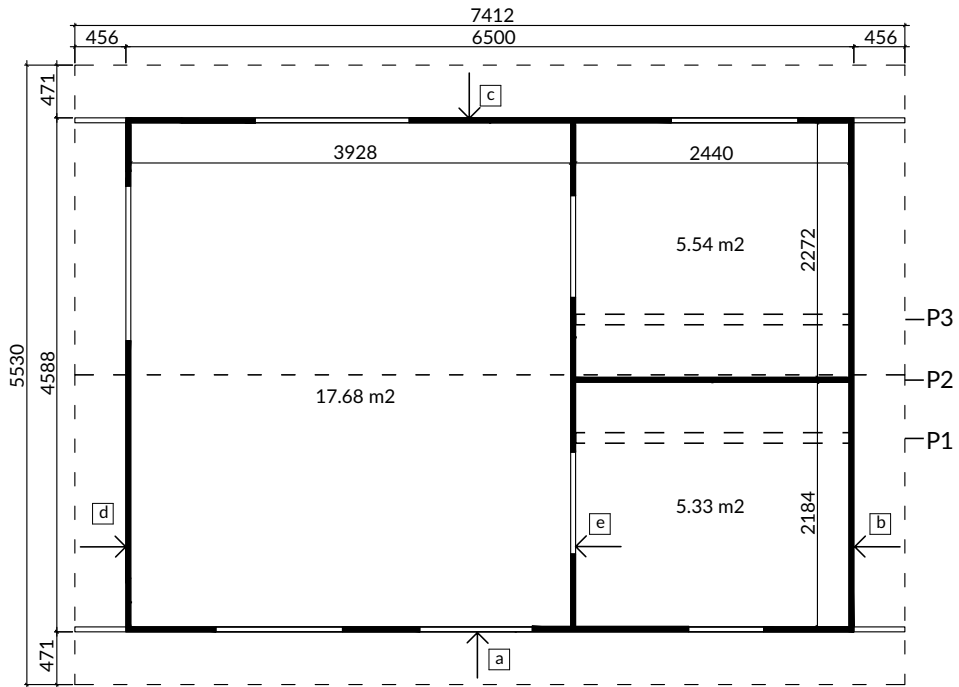

V-2

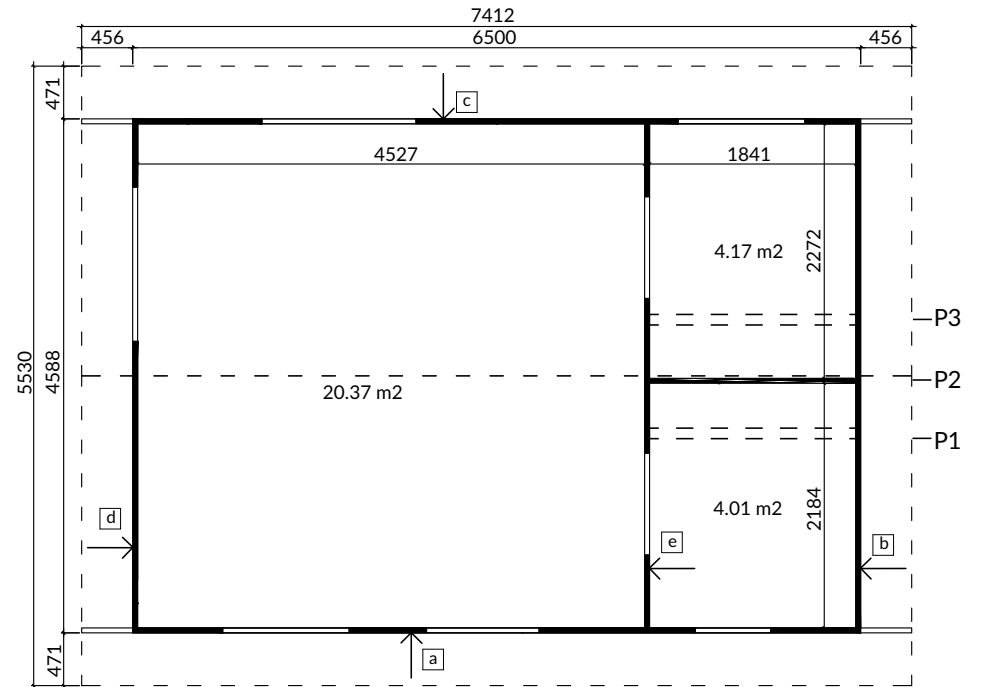

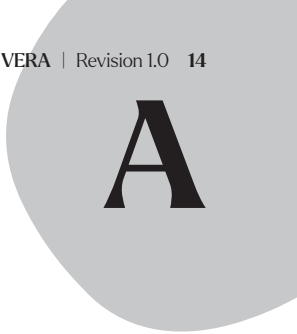

A

W1
x14
□ (120x18) x 3240mm (IAR2)

W2
x8
□ (90x18) x 3240mm (IAR1)

W3
x13
□ (146x44) x 4000mm (AR4)

W4
x13
□ (146x44) x 2304mm (AR6)

W5
x4
□ (146x44) x 4568mm (AR1)

W6
x4
□ (70x45) x 4298mm (AR2)

W7
x13
□ (70x45) x 4000mm (AR5)

W8
x6
□ (70x45) x 2480mm (AR3)

W9
x7
□ (70x45) x 2300mm (AR7)

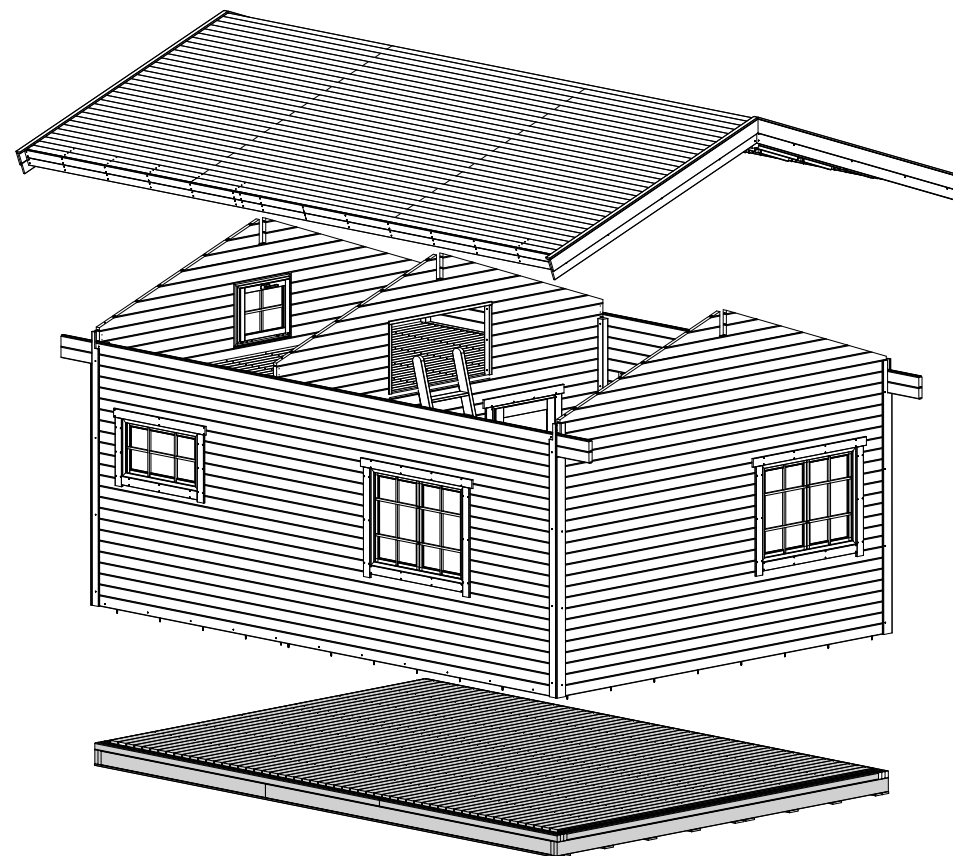

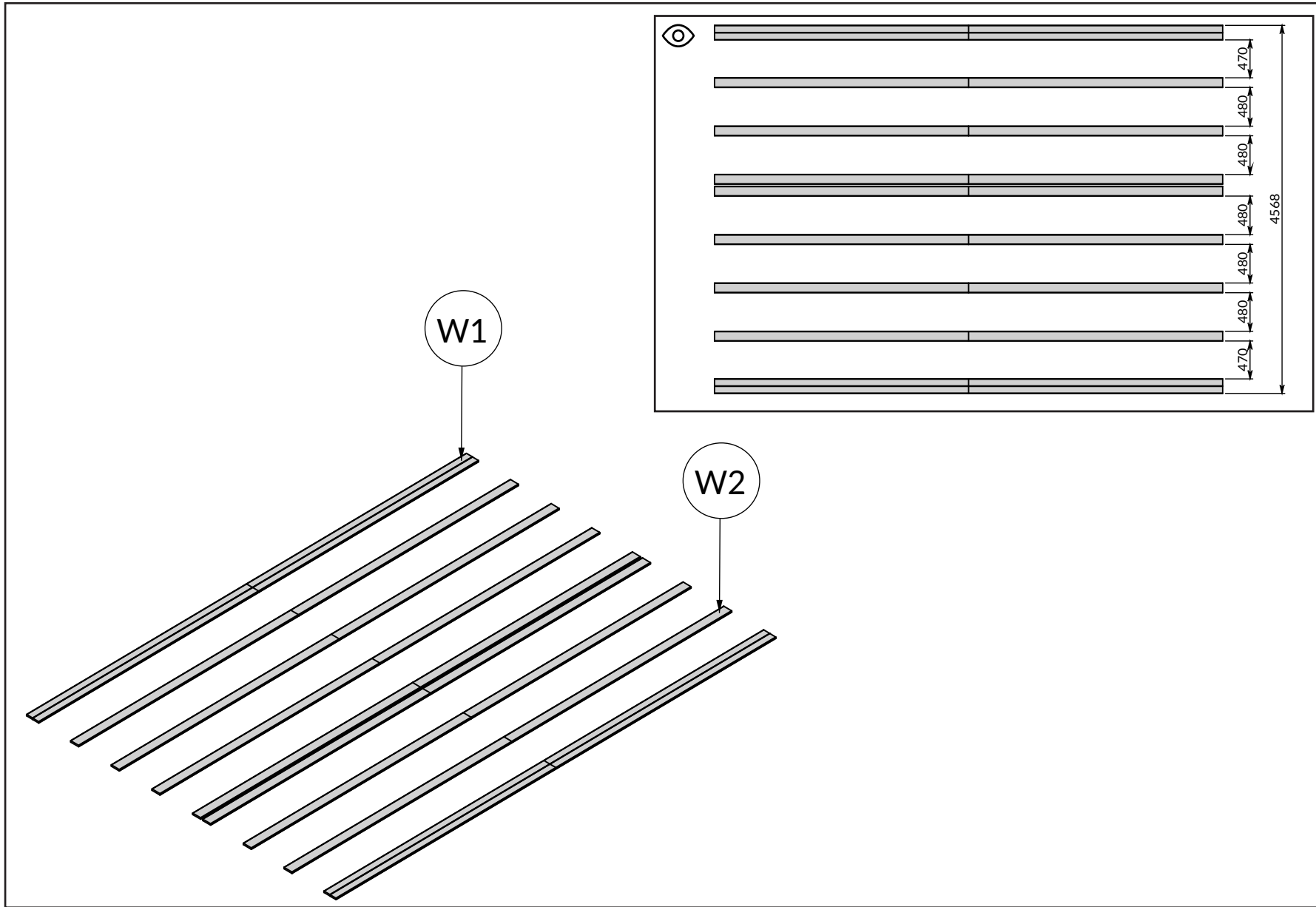

W1 x8

W2 x14

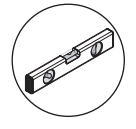
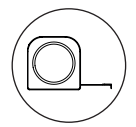

A|1→2→3→4→5→ B|1→2→3→4→5→6→7→8→9→10→11→12→13→14→15→16→17→18→19→20→
 C|1→2→3→4→5→6→7→8→9→ D|1→2→3→4→5→6→7→8→ E|1→2→3→4→5→6→7→
 F|1→2→3→4→5→6→7→ G|1→2→3→ H|1→2→3→ I|1→2→3→4→5→ J|1→2→3→4→

A1

A|1→2→3→4→5→ B|1→2→3→4→5→6→7→8→9→10→11→12→13→14→15→16→17→18→19→20→
C|1→2→3→4→5→6→7→8→9→ D|1→2→3→4→5→6→7→8→ E|1→2→3→4→5→6→7→
F|1→2→3→4→5→6→7→ G|1→2→3→ H|1→2→3→ I|1→2→3→4→5→ J|1→2→3→4→

A2

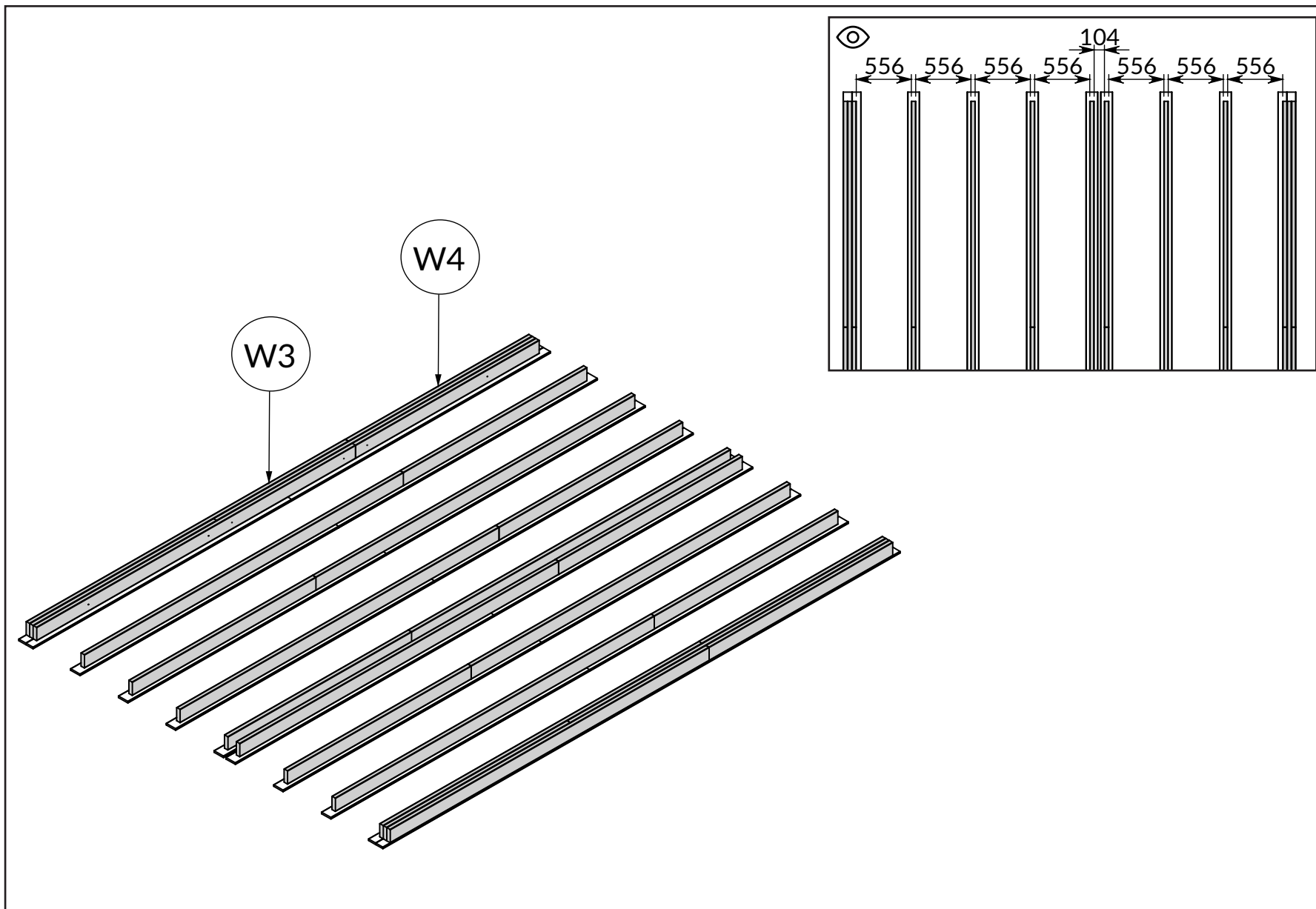

W3 x13

W4 x13

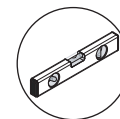
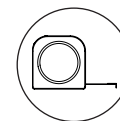

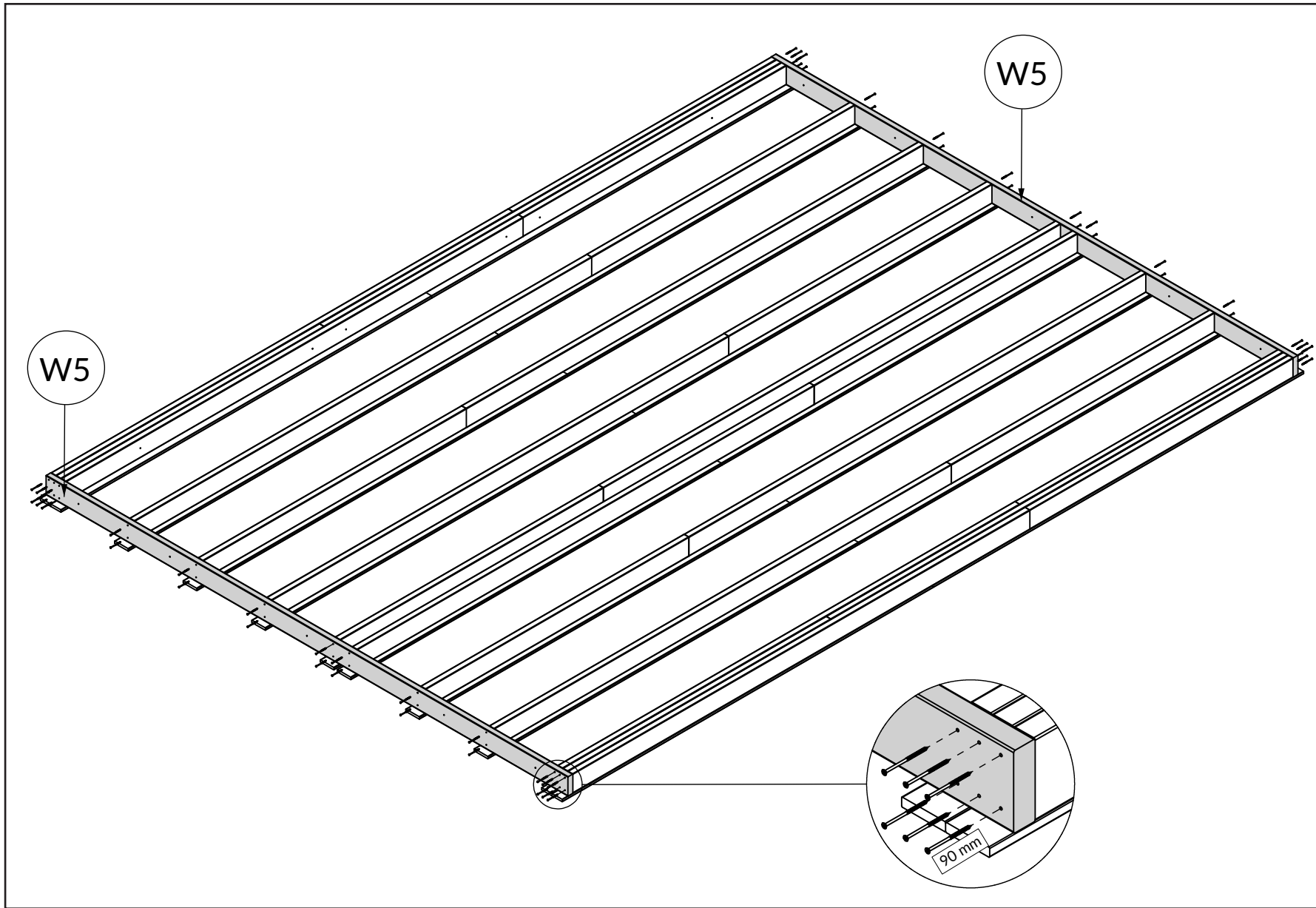

W5 x2

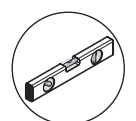
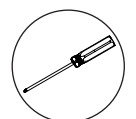
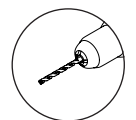

A|1→2→3→4→5→ B|1→2→3→4→5→6→7→8→9→10→11→12→13→14→15→16→17→18→19→20→
 C|1→2→3→4→5→6→7→8→9→ D|1→2→3→4→5→6→7→8→ E|1→2→3→4→5→6→7→
 F|1→2→3→4→5→6→7→ G|1→2→3→ H|1→2→3→ I|1→2→3→4→5→ J|1→2→3→4→

A3

A4

A|1→2→3→4→5→ B|1→2→3→4→5→6→7→8→9→10→11→12→13→14→15→16→17→18→19→20→
C|1→2→3→4→5→6→7→8→9→ D|1→2→3→4→5→6→7→8→ E|1→2→3→4→5→6→7→
F|1→2→3→4→5→6→7→ G|1→2→3→ H|1→2→3→ I|1→2→3→4→5→ J|1→2→3→4→

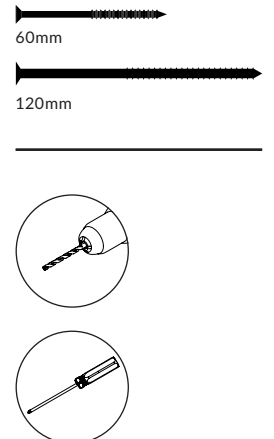
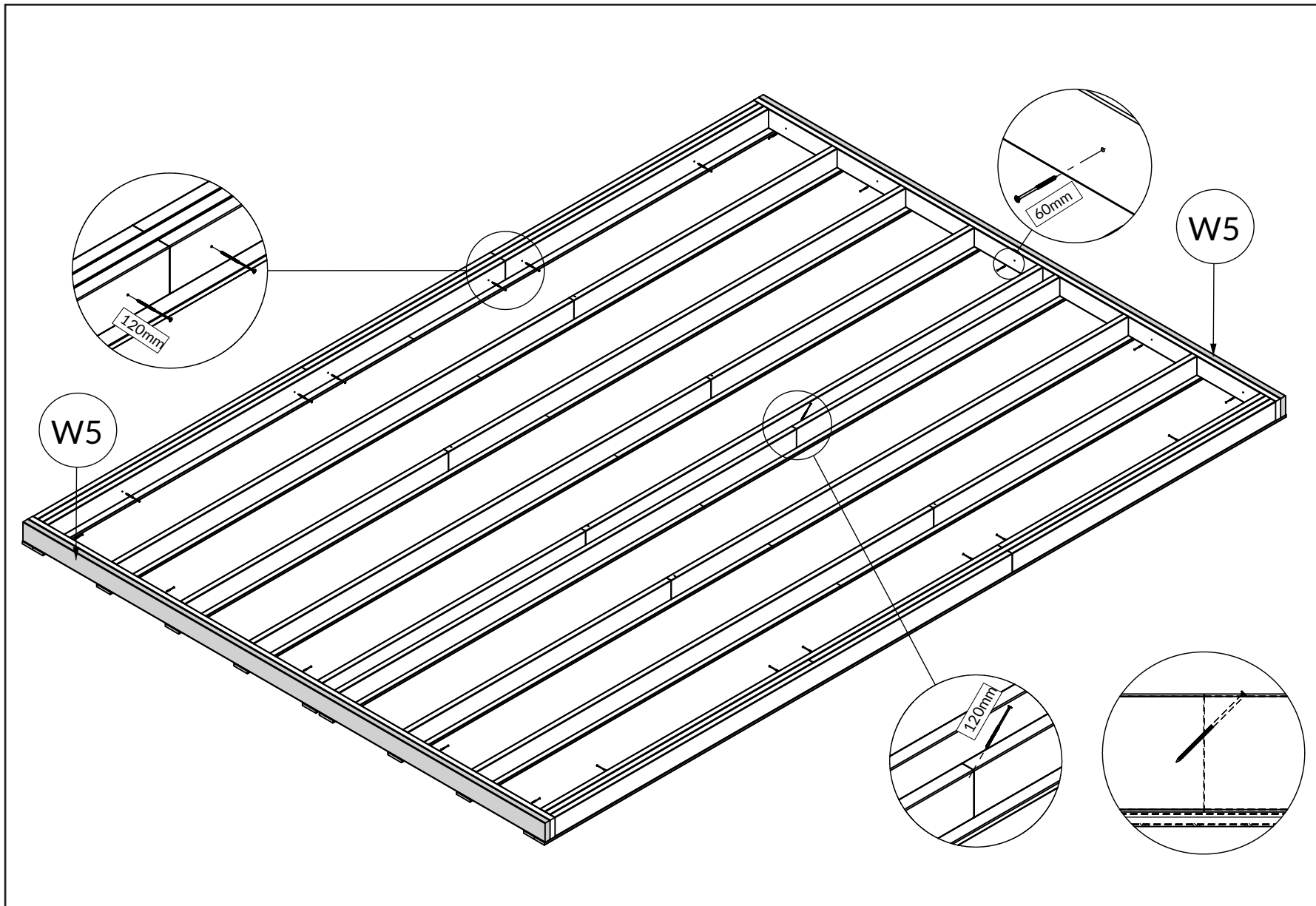

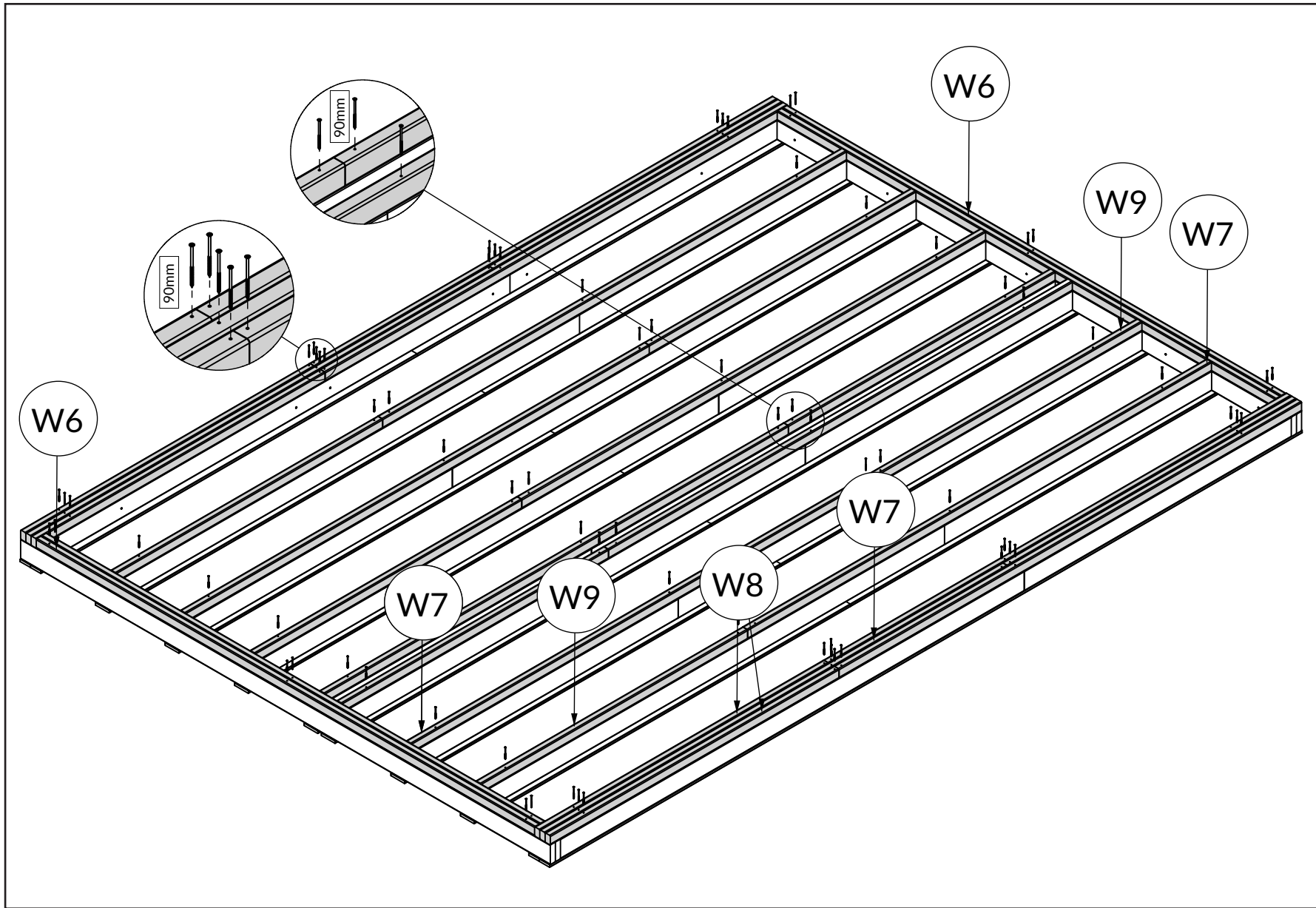



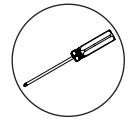
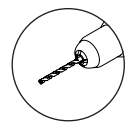







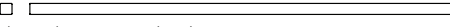

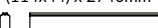

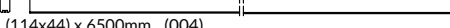



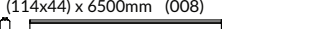
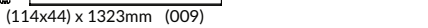



- W6 x4
- W7 x13
- W8 x6
- W9 x7

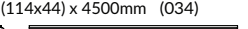
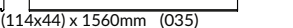
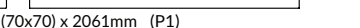



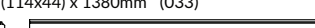

A|1→2→3→4→5→ B|1→2→3→4→5→6→7→8→9→10→11→12→13→14→15→16→17→18→19→20→
 C|1→2→3→4→5→6→7→8→9→ D|1→2→3→4→5→6→7→8→ E|1→2→3→4→5→6→7→
 F|1→2→3→4→5→6→7→ G|1→2→3→ H|1→2→3→ I|1→2→3→4→5→ J|1→2→3→4→

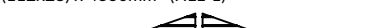
A5

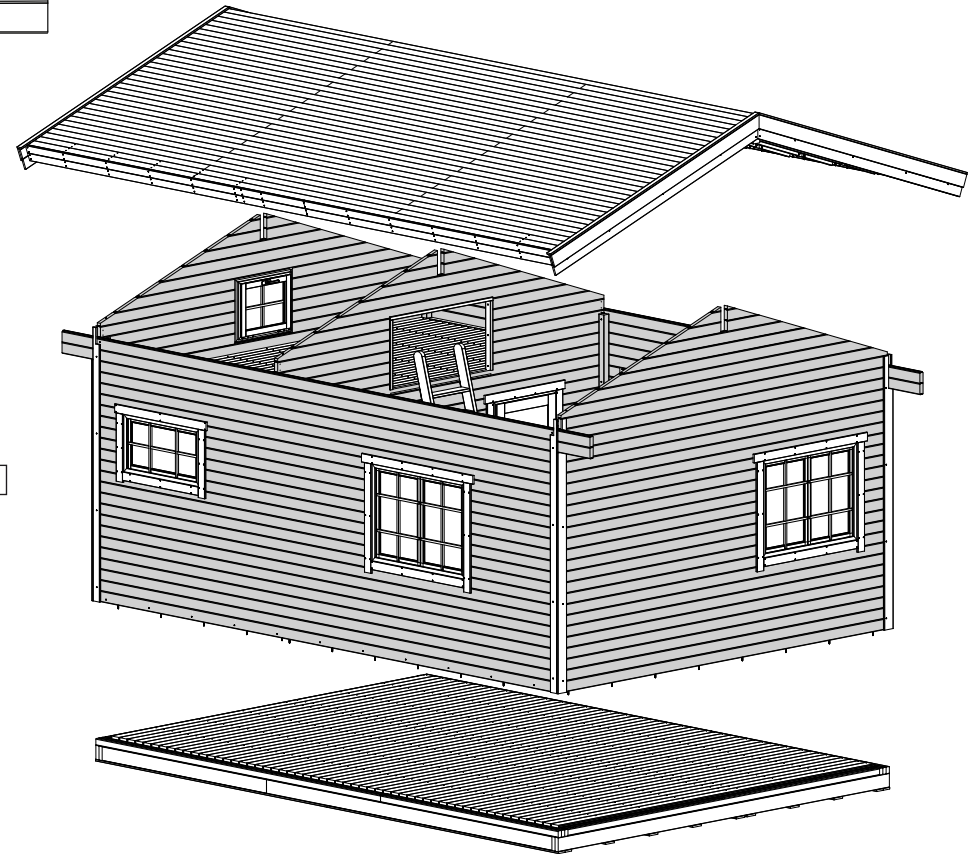
B

- W10 
x4 (70x70) x 4360mm (PT1)
- W11 
x4 (70x70) x 3136mm (PT2)
- W12 
x26 (114x44) x 2740mm (001)
- W13 
x18 (114x44) x 805mm (002)
- W14 
x6 (114x44) x 1265mm (003)
- W15 
x16 (114x44) x 6500mm (004)
- W16 
x4 (114x44) x 7412mm (005)
- W17 
x15 (114x44) x 500mm (012)
- W18 
x1 (114x44) x 6500mm (008)
- W19 
x9 (114x44) x 1323mm (009)
- W20 
x3 (114x44) x 3807mm (010)
- W21 
x38 (114x44) x 4500mm (016)
- W22 
x1 (114x44) x 4500mm (017)
- W23 
x8 (114x44) x 1853mm (027)
- W24 
x2 (86x44) x 650mm (030)
- W25 
x1 (86x44) x 1380mm (031)
- W26 
x1 (114x44) x 4500mm (034)
- W27 
x8 (114x44) x 1560mm (035)
- W28 
x1 (70x70) x 2061mm (P1)
- W29 
x8 (70x70) x 2700mm (P2)
- W30 
x34 (114x44) x 650mm (032)
- W31 
x17 (114x44) x 1380mm (033)
- W32 
x9 (114x44) x 2630mm (018)
- W33 
x6 (114x44) x 2177mm (011)
- W34 
x1 (112x28) x 4360mm (HLL-1)
- W35 (WA-1) 
x1
- W36 (WC-1) 
x1
- W37 (WB-1) 
x1

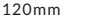

-  90mm
-  60mm
-  180mm
-  120mm
-  40mm



V-1

a	W11		x1	W11.1	W11.2
	W11		x1	W11.3	
b	P1		x1	W10.1	W10.2
	P2		x1	W10.3	W10.4
	P3		x1	W10.5	W10.6
c	W10		x1	W10.7	
	W11		x1	W11.4	
d	W10		x1	W10	

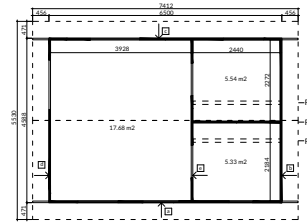

V-1



A|1→2→3→4→5→ B|1→2→3→4→5→6→7→8→9→10→11→12→13→14→15→16→17→18→19→20→
 C|1→2→3→4→5→6→7→8→9→ D|1→2→3→4→5→6→7→8→ E|1→2→3→4→5→6→7→
 F|1→2→3→4→5→6→7→ G|1→2→3→ H|1→2→3→ I|1→2→3→4→5→ J|1→2→3→4→

B1

B2

A|1→2→3→4→5→ B|1→2→3→4→5→6→7→8→9→10→11→12→13→14→15→16→17→18→19→20→
 C|1→2→3→4→5→6→7→8→9→ D|1→2→3→4→5→6→7→8→ E|1→2→3→4→5→6→7→
 F|1→2→3→4→5→6→7→ G|1→2→3→ H|1→2→3→ I|1→2→3→4→5→ J|1→2→3→4→

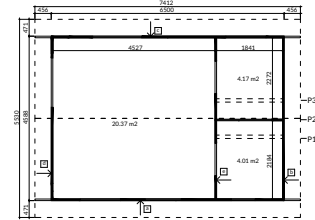

V-2

V-2

a	W11		x1	W11.5	W11.6
	W11		x1	W11.7	
b	P1		x1	W10.1	W10.2
	P2		x1	W10.3	W10.4
	P3		x1	W10.5	W10.6
c	W10		x1	W10	
	W11		x1	W11.8	
d	W10		x1	W10	

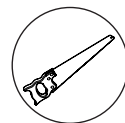

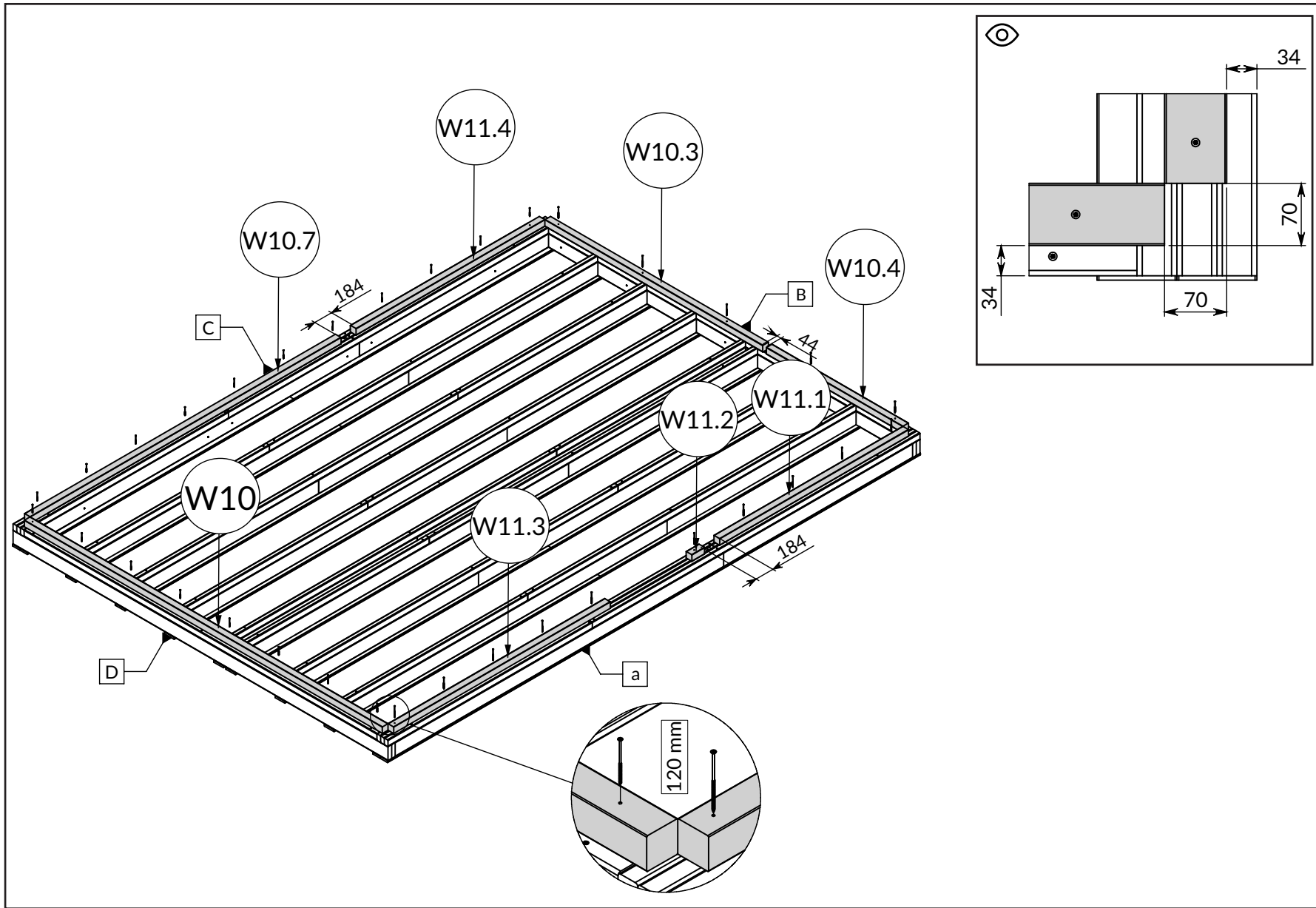

- W10 x1
- W10.3 x1
- W10.4 x1
- W10.7 x1
- W11.1 x1
- W11.2 x1
- W11.3 x1
- W11.4 x1

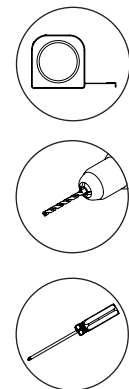

A|1→2→3→4→5→ B|1→2→3→4→5→6→7→8→9→10→11→12→13→14→15→16→17→18→19→20→
 C|1→2→3→4→5→6→7→8→9→ D|1→2→3→4→5→6→7→8→ E|1→2→3→4→5→6→7→
 F|1→2→3→4→5→6→7→ G|1→2→3→ H|1→2→3→ I|1→2→3→4→5→ J|1→2→3→4→

B3

A|1→2→3→4→5→ B|1→2→3→4→5→6→7→8→9→10→11→12→13→14→15→16→17→18→19→20→
C|1→2→3→4→5→6→7→8→9→ D|1→2→3→4→5→6→7→8→ E|1→2→3→4→5→6→7→
F|1→2→3→4→5→6→7→ G|1→2→3→ H|1→2→3→ I|1→2→3→4→5→ J|1→2→3→4→

B4

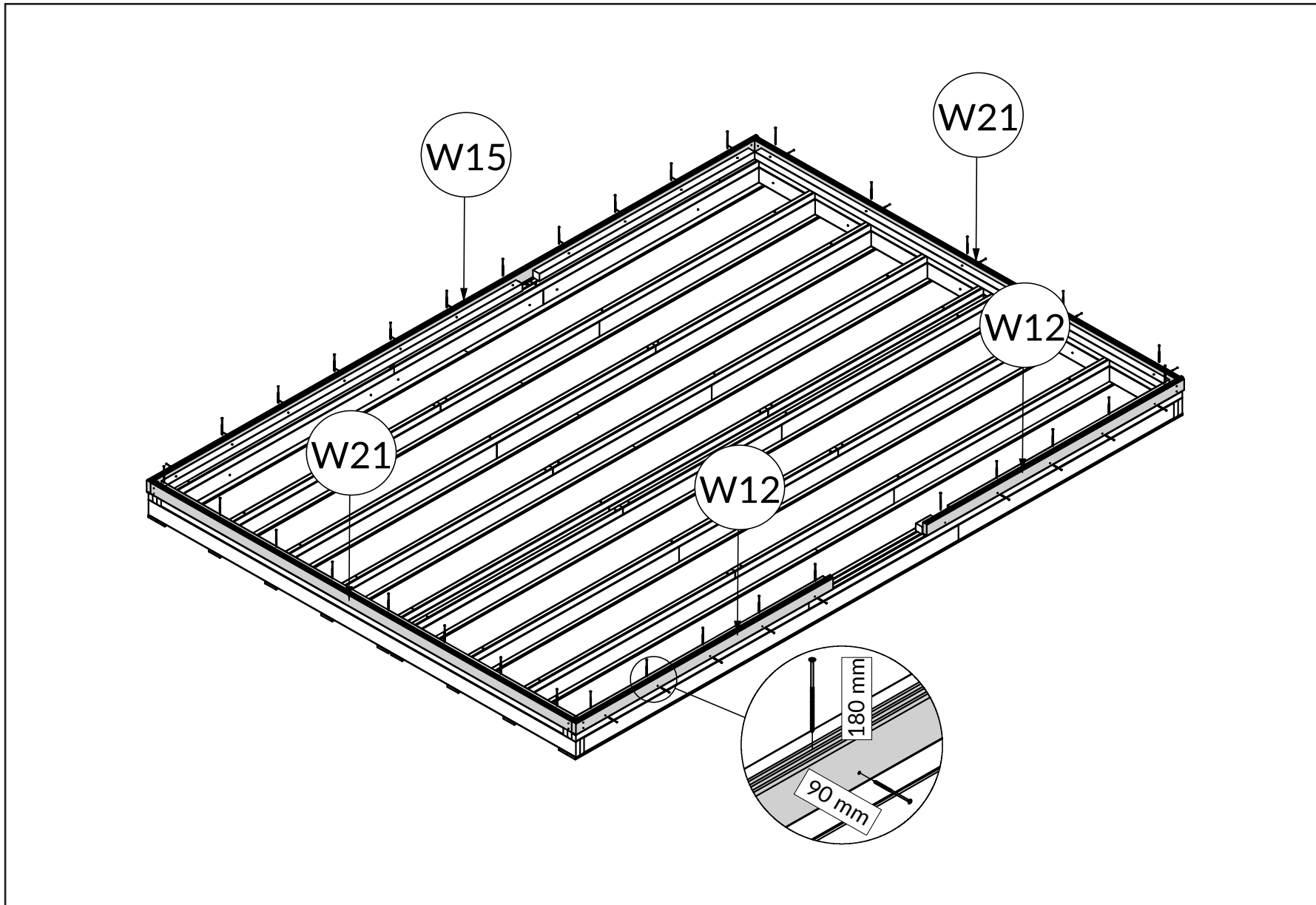

W12 x2

W15 x1

W21 x2

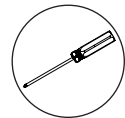
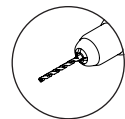
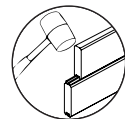
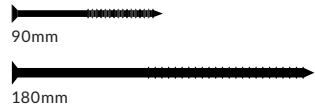

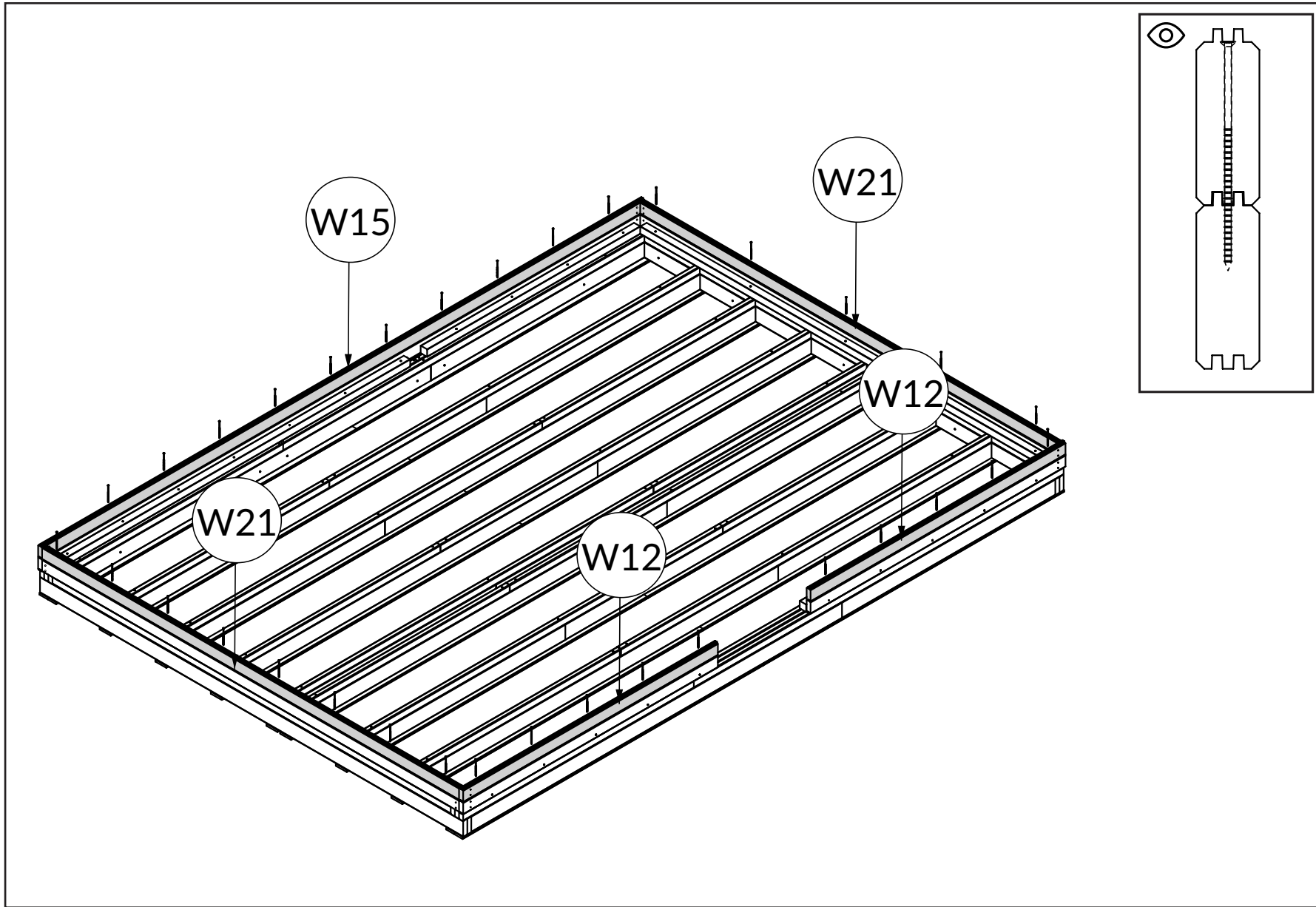

- W12 x2
- W15 x1
- W21 x2

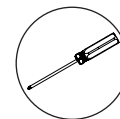
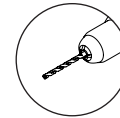
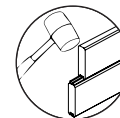

A|1→2→3→4→5→ B|1→2→3→4→5→6→7→8→9→10→11→12→13→14→15→16→17→18→19→20→
 C|1→2→3→4→5→6→7→8→9→ D|1→2→3→4→5→6→7→8→ E|1→2→3→4→5→6→7→
 F|1→2→3→4→5→6→7→ G|1→2→3→ H|1→2→3→ I|1→2→3→4→5→ J|1→2→3→4→

B5

A|1→2→3→4→5→ B|1→2→3→4→5→6→7→8→9→10→11→12→13→14→15→16→17→18→19→20→
C|1→2→3→4→5→6→7→8→9→ D|1→2→3→4→5→6→7→8→ E|1→2→3→4→5→6→7→
F|1→2→3→4→5→6→7→ G|1→2→3→ H|1→2→3→ I|1→2→3→4→5→ J|1→2→3→4→

B6

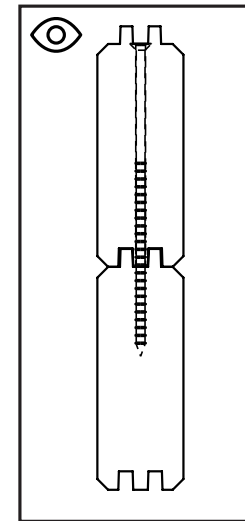
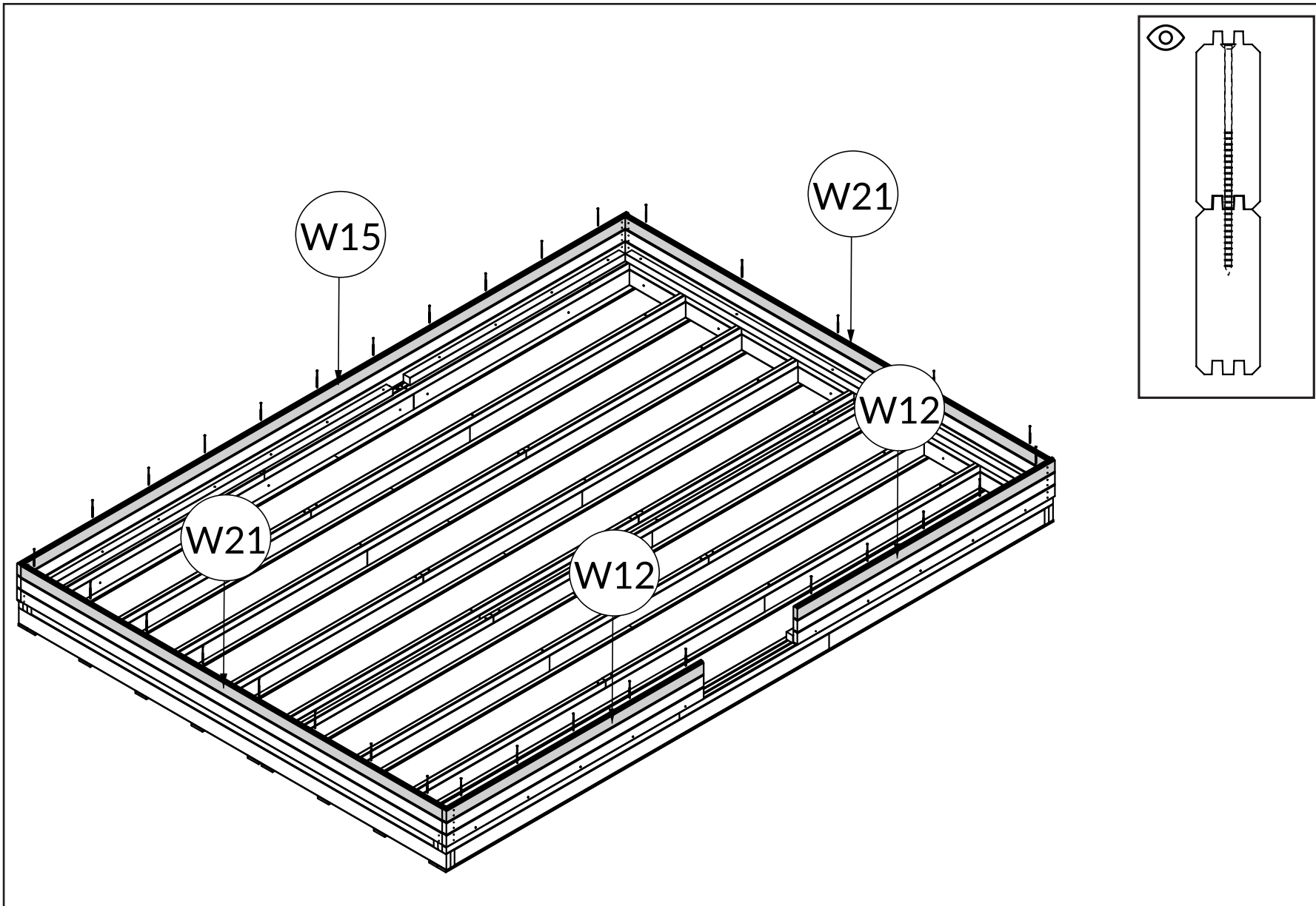

W12 x2

W15 x1

W21 x2

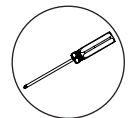
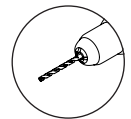
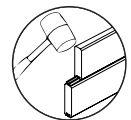

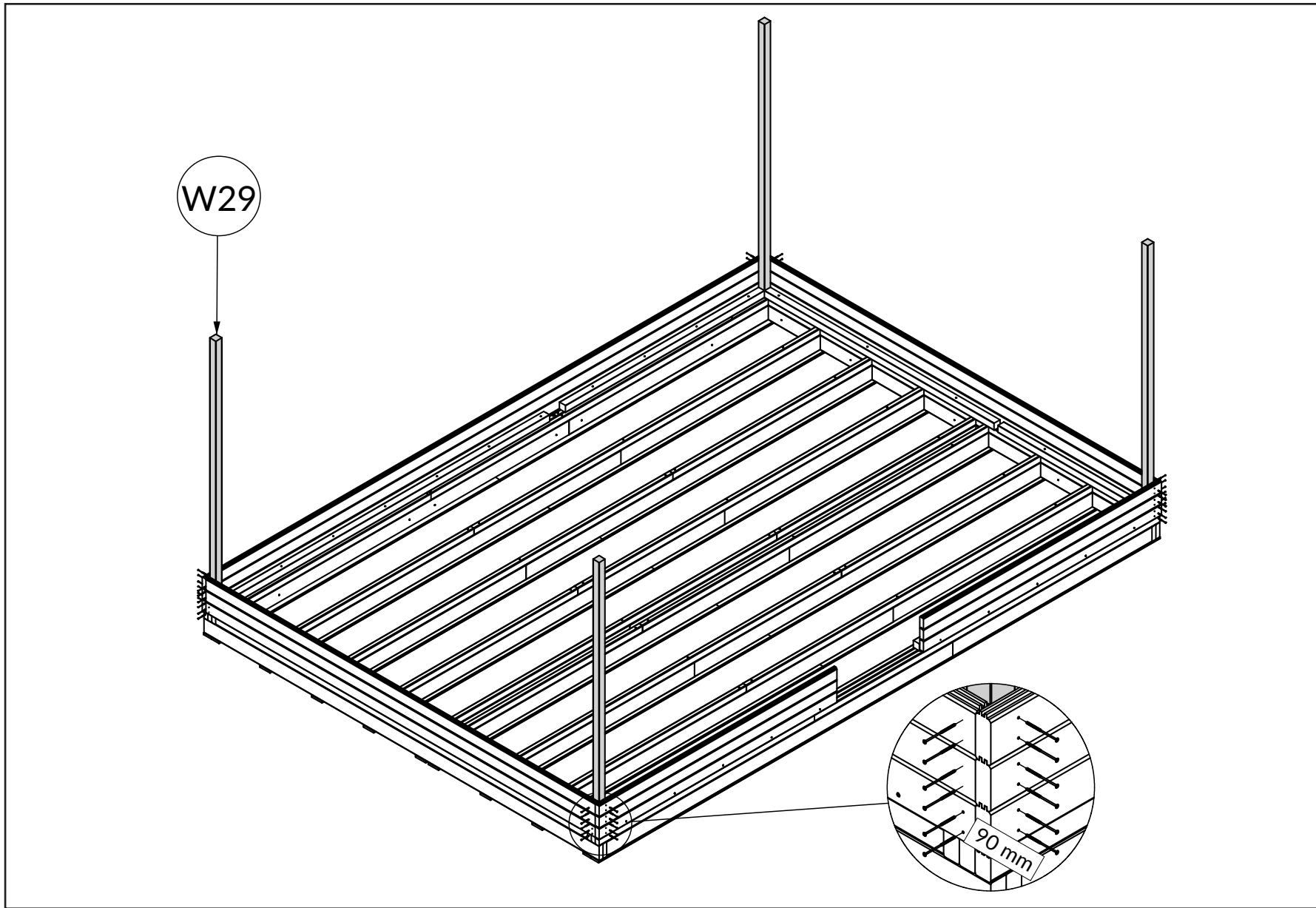

W29 x4

W29

90mm

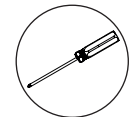
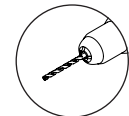
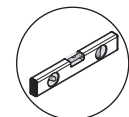

A|1→2→3→4→5→ B|1→2→3→4→5→6→7→8→9→10→11→12→13→14→15→16→17→18→19→20→
 C|1→2→3→4→5→6→7→8→9→ D|1→2→3→4→5→6→7→8→ E|1→2→3→4→5→6→7→
 F|1→2→3→4→5→6→7→ G|1→2→3→ H|1→2→3→ I|1→2→3→4→5→ J|1→2→3→4→

B7

A|1→2→3→4→5→ B|1→2→3→4→5→6→7→8→9→10→11→12→13→14→15→16→17→18→19→20→
C|1→2→3→4→5→6→7→8→9→ D|1→2→3→4→5→6→7→8→ E|1→2→3→4→5→6→7→
F|1→2→3→4→5→6→7→ G|1→2→3→ H|1→2→3→ I|1→2→3→4→5→ J|1→2→3→4→

B8

W29 x2

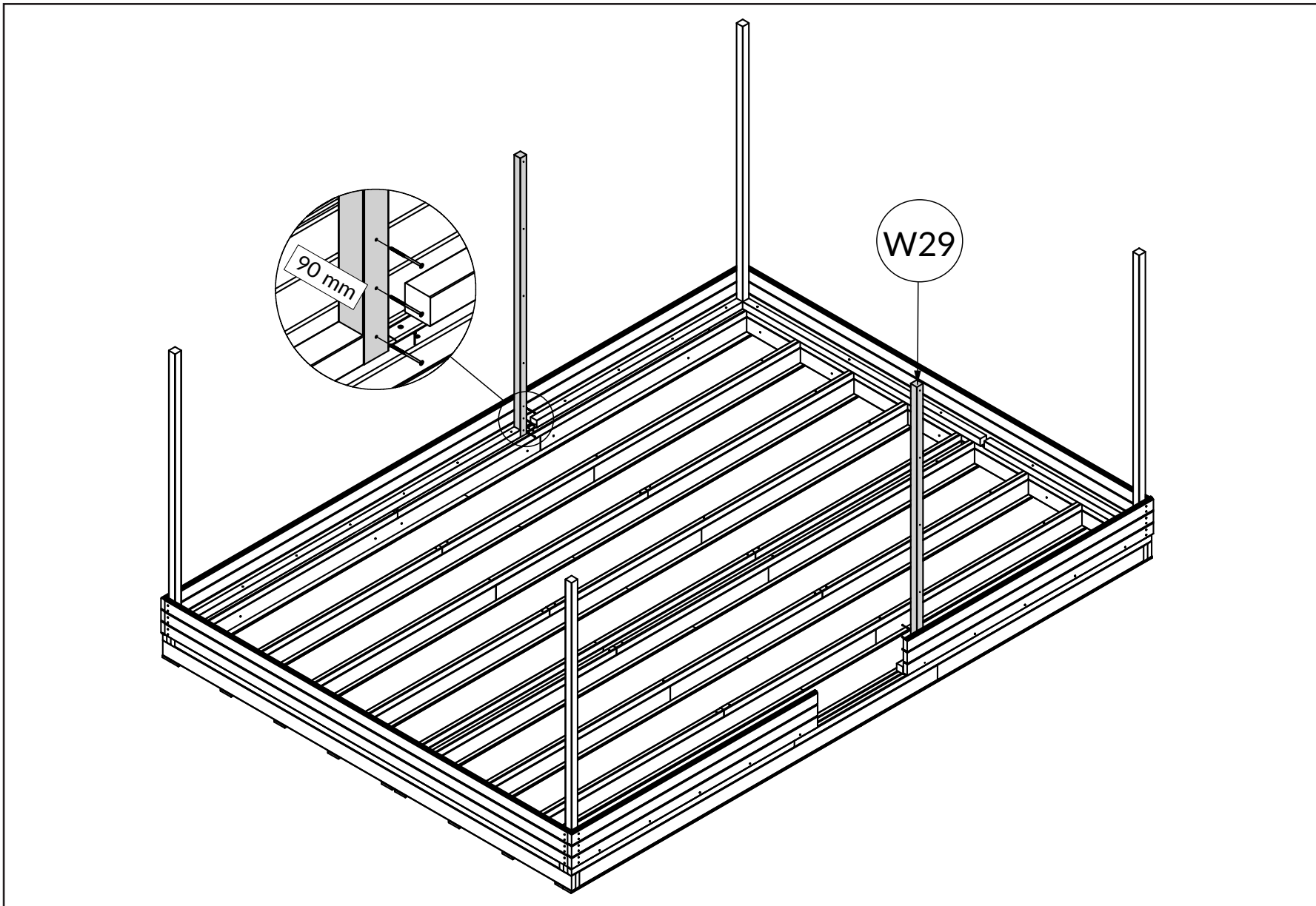

W29

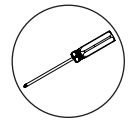
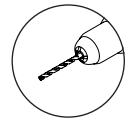
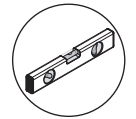

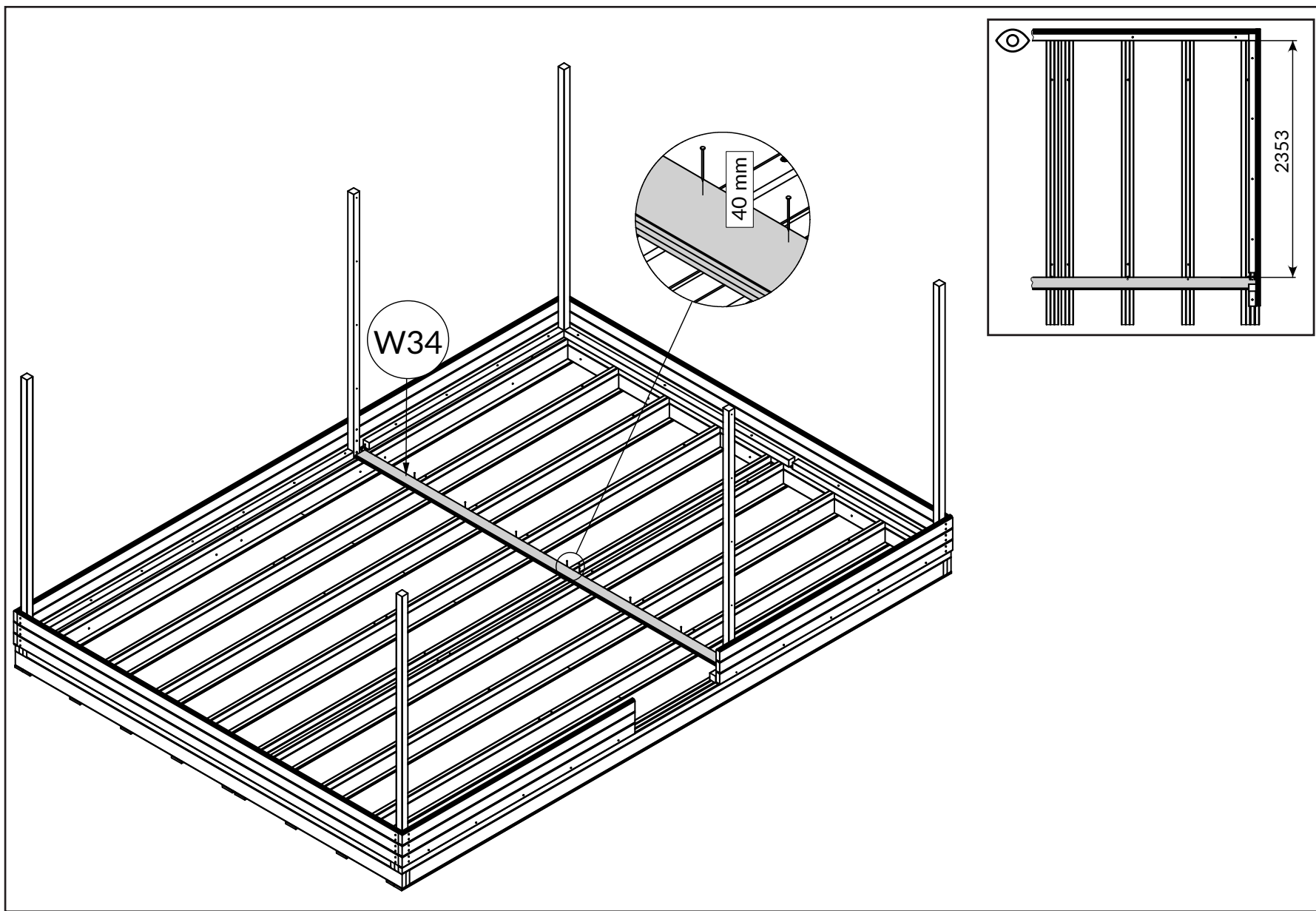

W34 x1

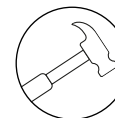
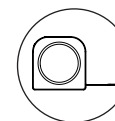
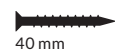

A|1→2→3→4→5→ B|1→2→3→4→5→6→7→8→9→10→11→12→13→14→15→16→17→18→19→20→
 C|1→2→3→4→5→6→7→8→9→ D|1→2→3→4→5→6→7→8→ E|1→2→3→4→5→6→7→
 F|1→2→3→4→5→6→7→ G|1→2→3→ H|1→2→3→ I|1→2→3→4→5→ J|1→2→3→4→

B9

A|1→2→3→4→5→ B|1→2→3→4→5→6→7→8→9→10→11→12→13→14→15→16→17→18→19→20→
 C|1→2→3→4→5→6→7→8→9→ D|1→2→3→4→5→6→7→8→ E|1→2→3→4→5→6→7→
 F|1→2→3→4→5→6→7→ G|1→2→3→ H|1→2→3→ I|1→2→3→4→5→ J|1→2→3→4→

B10

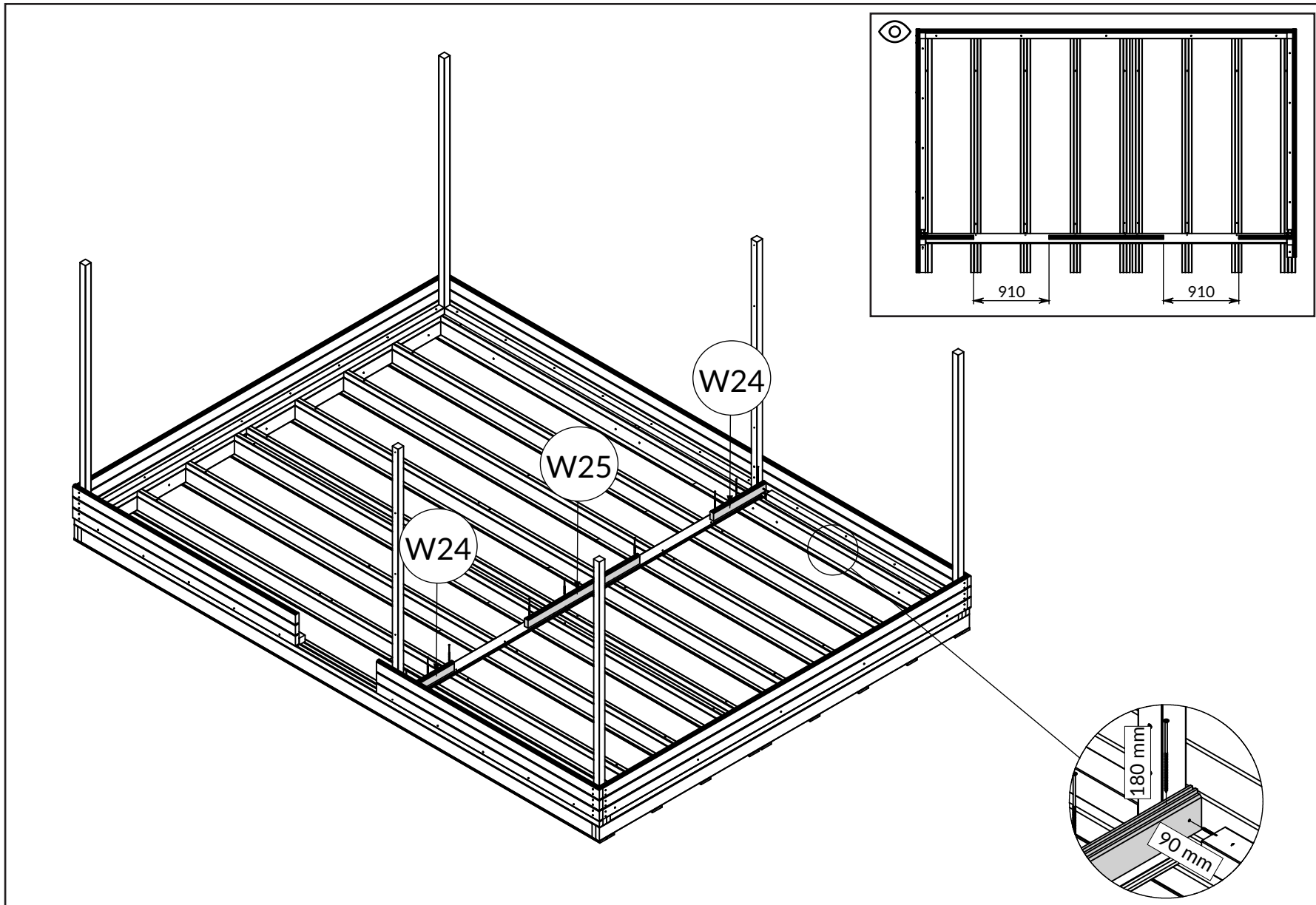

W24 x2

W25 x1

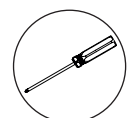
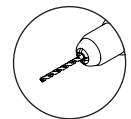
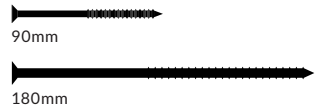

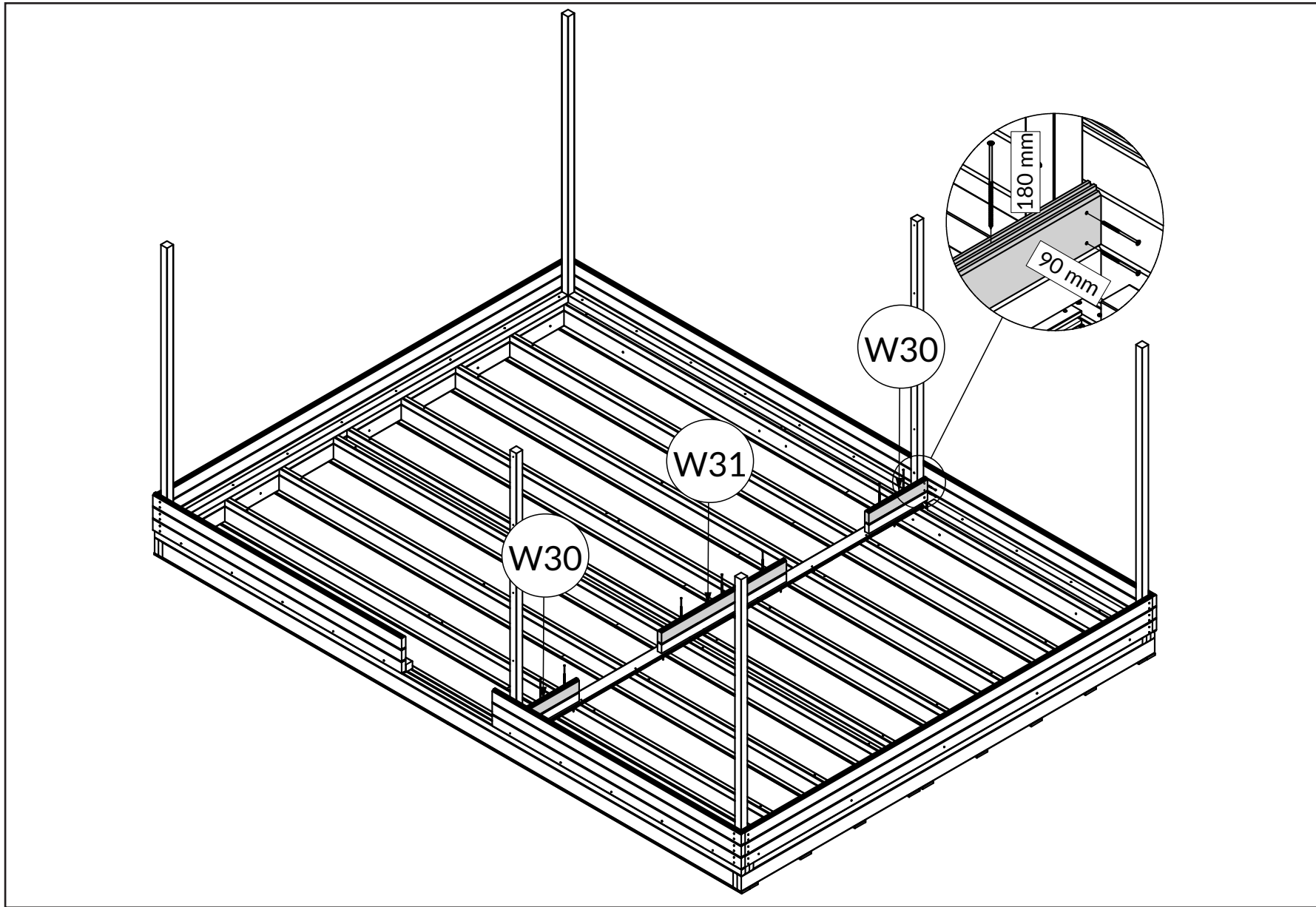

W30 x2

W31 x1

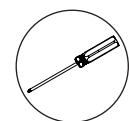
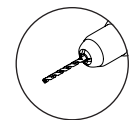

A|1→2→3→4→5→ B|1→2→3→4→5→6→7→8→9→10→11→12→13→14→15→16→17→18→19→20→
 C|1→2→3→4→5→6→7→8→9→ D|1→2→3→4→5→6→7→8→ E|1→2→3→4→5→6→7→
 F|1→2→3→4→5→6→7→ G|1→2→3→ H|1→2→3→ I|1→2→3→4→5→ J|1→2→3→4→

B11

A|1→2→3→4→5→ B|1→2→3→4→5→6→7→8→9→10→11→12→13→14→15→16→17→18→19→20→
C|1→2→3→4→5→6→7→8→9→ D|1→2→3→4→5→6→7→8→ E|1→2→3→4→5→6→7→
F|1→2→3→4→5→6→7→ G|1→2→3→ H|1→2→3→ I|1→2→3→4→5→ J|1→2→3→4→

B12

W30 x2

W31 x1

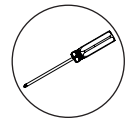
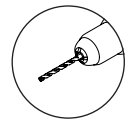
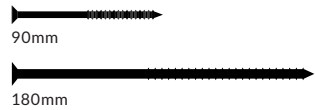
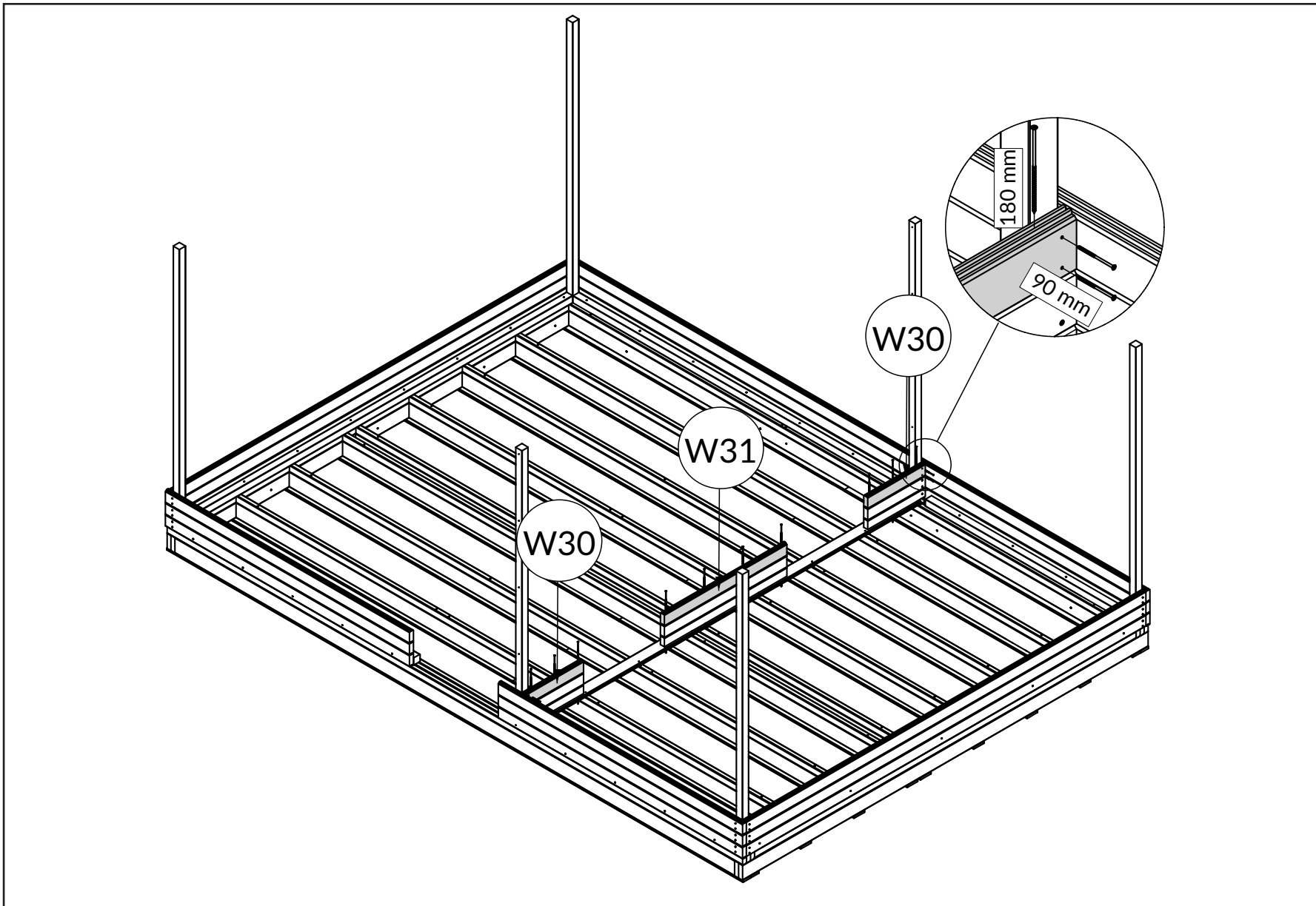

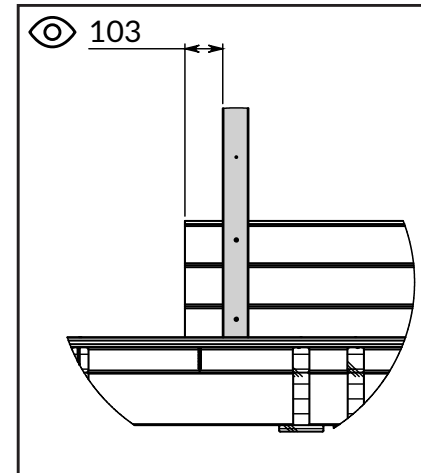
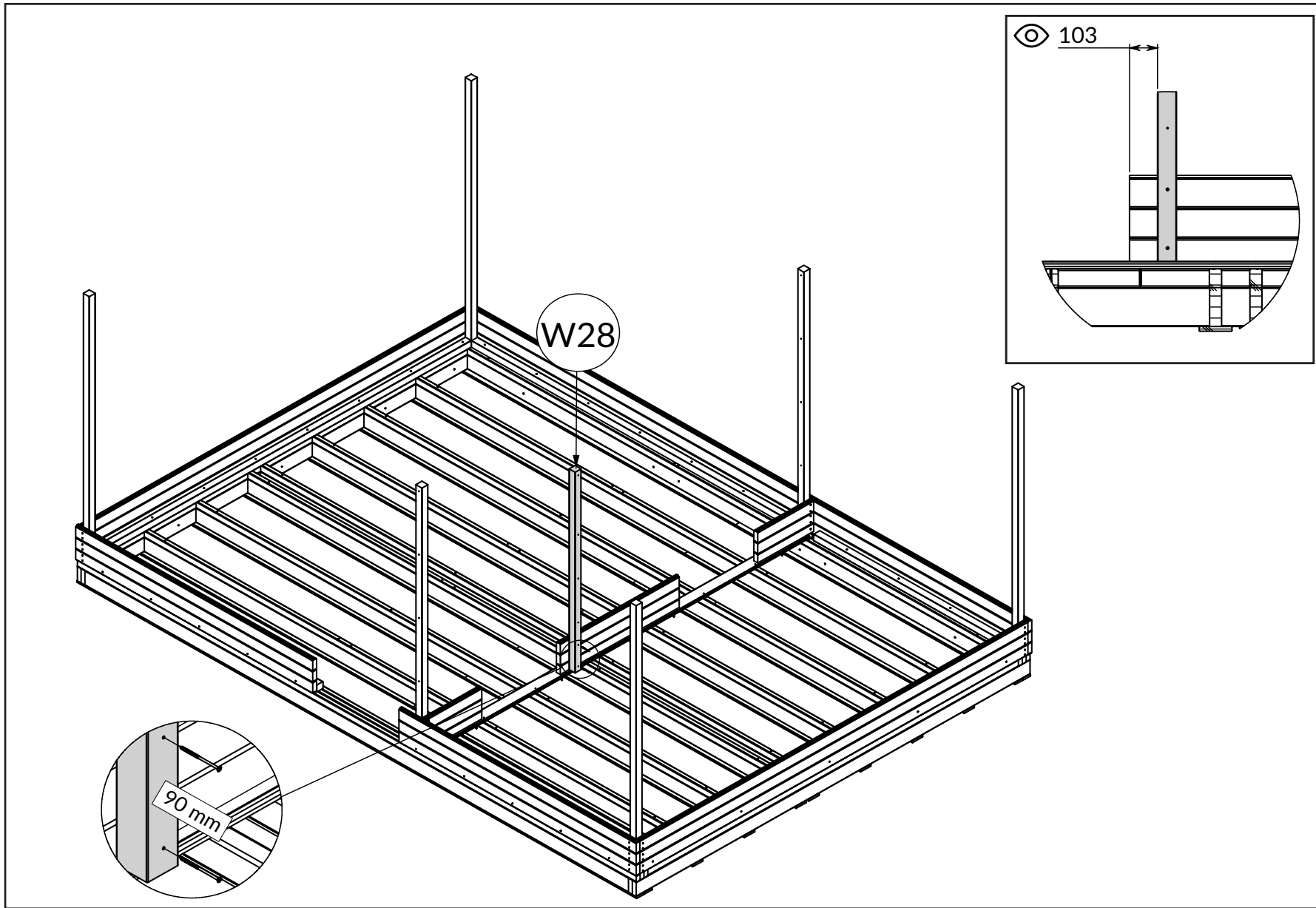

W28 x1

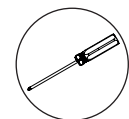
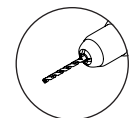
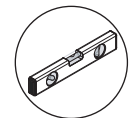
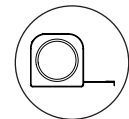

A|1→2→3→4→5→ B|1→2→3→4→5→6→7→8→9→10→11→12→13→14→15→16→17→18→19→20→
 C|1→2→3→4→5→6→7→8→9→ D|1→2→3→4→5→6→7→8→ E|1→2→3→4→5→6→7→
 F|1→2→3→4→5→6→7→ G|1→2→3→ H|1→2→3→ I|1→2→3→4→5→ J|1→2→3→4→

B13

A|1→2→3→4→5→ B|1→2→3→4→5→6→7→8→9→10→11→12→13→14→15→16→17→18→19→20→
C|1→2→3→4→5→6→7→8→9→ D|1→2→3→4→5→6→7→8→ E|1→2→3→4→5→6→7→
F|1→2→3→4→5→6→7→ G|1→2→3→ H|1→2→3→ I|1→2→3→4→5→ J|1→2→3→4→

B14

W54 x1

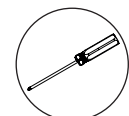
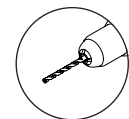
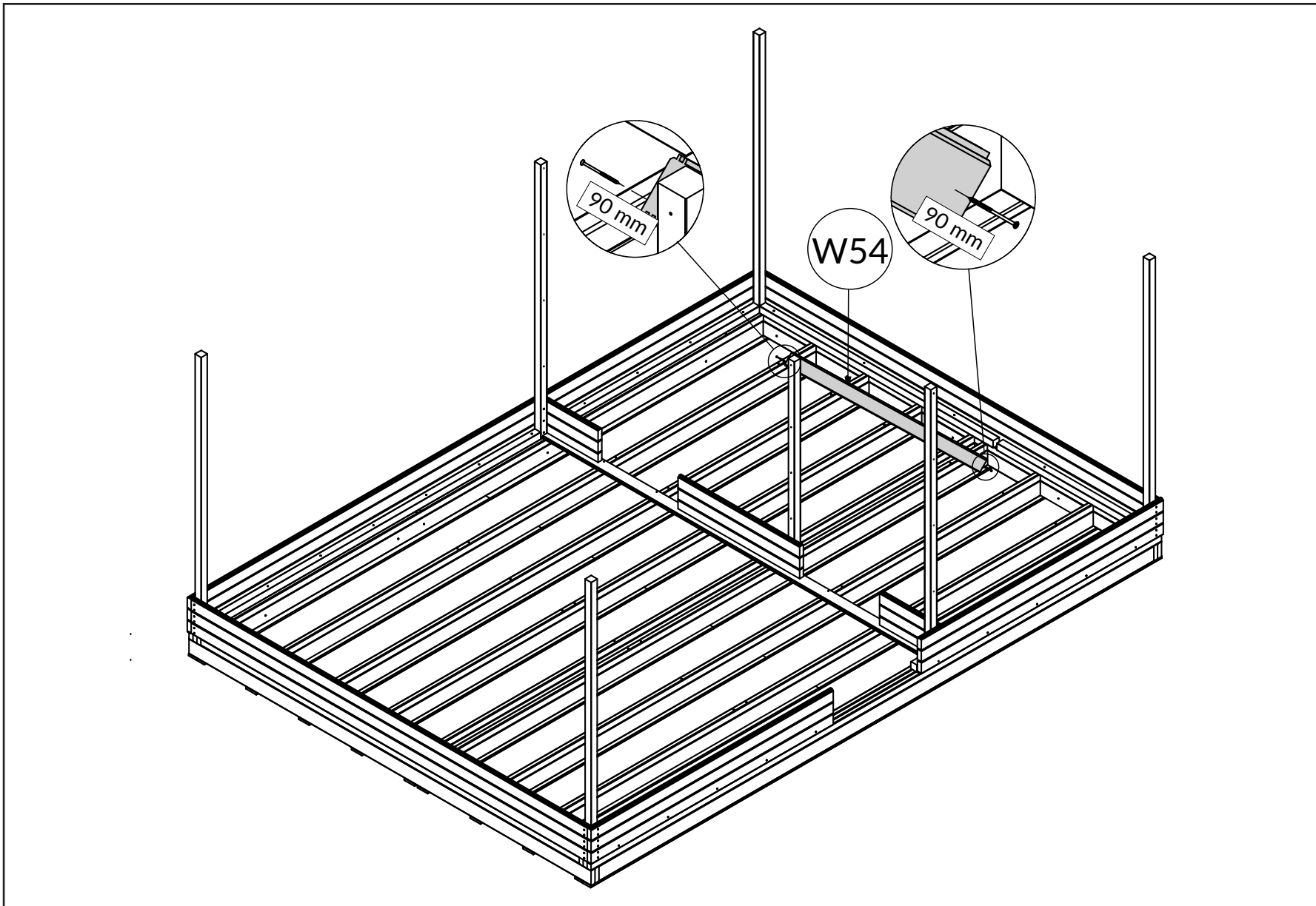

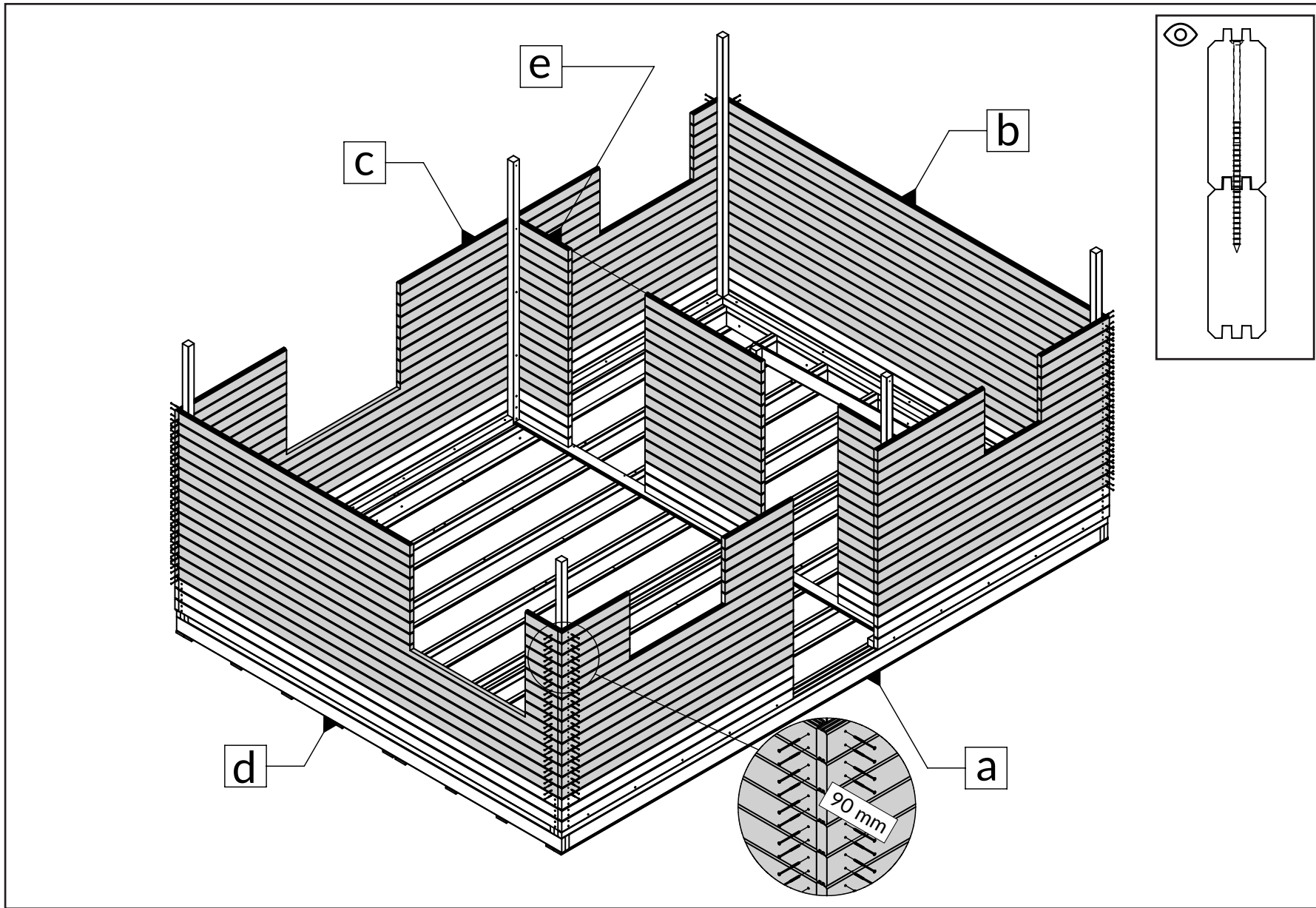

A | 1 → 2 → 3 → 4 → 5 → **B** | 1 → 2 → 3 → 4 → 5 → 6 → 7 → 8 → 9 → 10 → 11 → 12 → 13 → 14 → **15** → 16 → 17 → 18 → 19 → 20 →
C | 1 → 2 → 3 → 4 → 5 → 6 → 7 → 8 → 9 → **D** | 1 → 2 → 3 → 4 → 5 → 6 → 7 → 8 → **E** | 1 → 2 → 3 → 4 → 5 → 6 → 7 →
F | 1 → 2 → 3 → 4 → 5 → 6 → 7 → **G** | 1 → 2 → 3 → **H** | 1 → 2 → 3 → **I** | 1 → 2 → 3 → 4 → 5 → **J** | 1 → 2 → 3 → 4 →

B15

A|1→2→3→4→5→ B|1→2→3→4→5→6→7→8→9→10→11→12→13→14→15→16→17→18→19→20→
C|1→2→3→4→5→6→7→8→9→ D|1→2→3→4→5→6→7→8→ E|1→2→3→4→5→6→7→
F|1→2→3→4→5→6→7→ G|1→2→3→ H|1→2→3→ I|1→2→3→4→5→ J|1→2→3→4→

B15.1

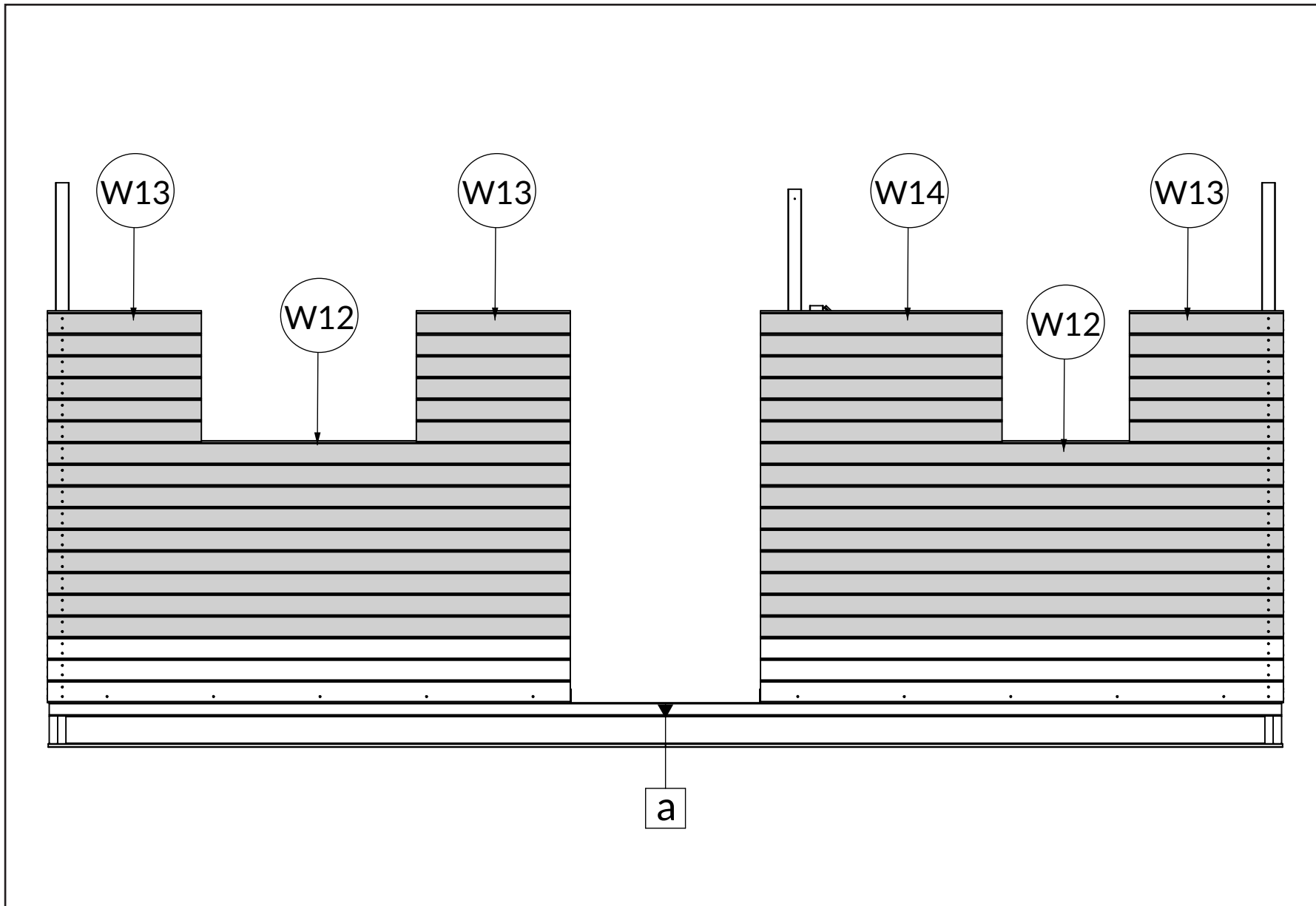

W12 x18

W13 x18

W14 x6



90mm

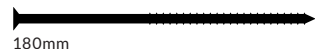

180mm

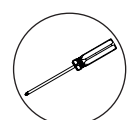
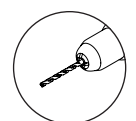
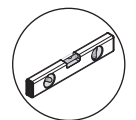
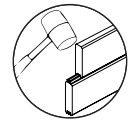

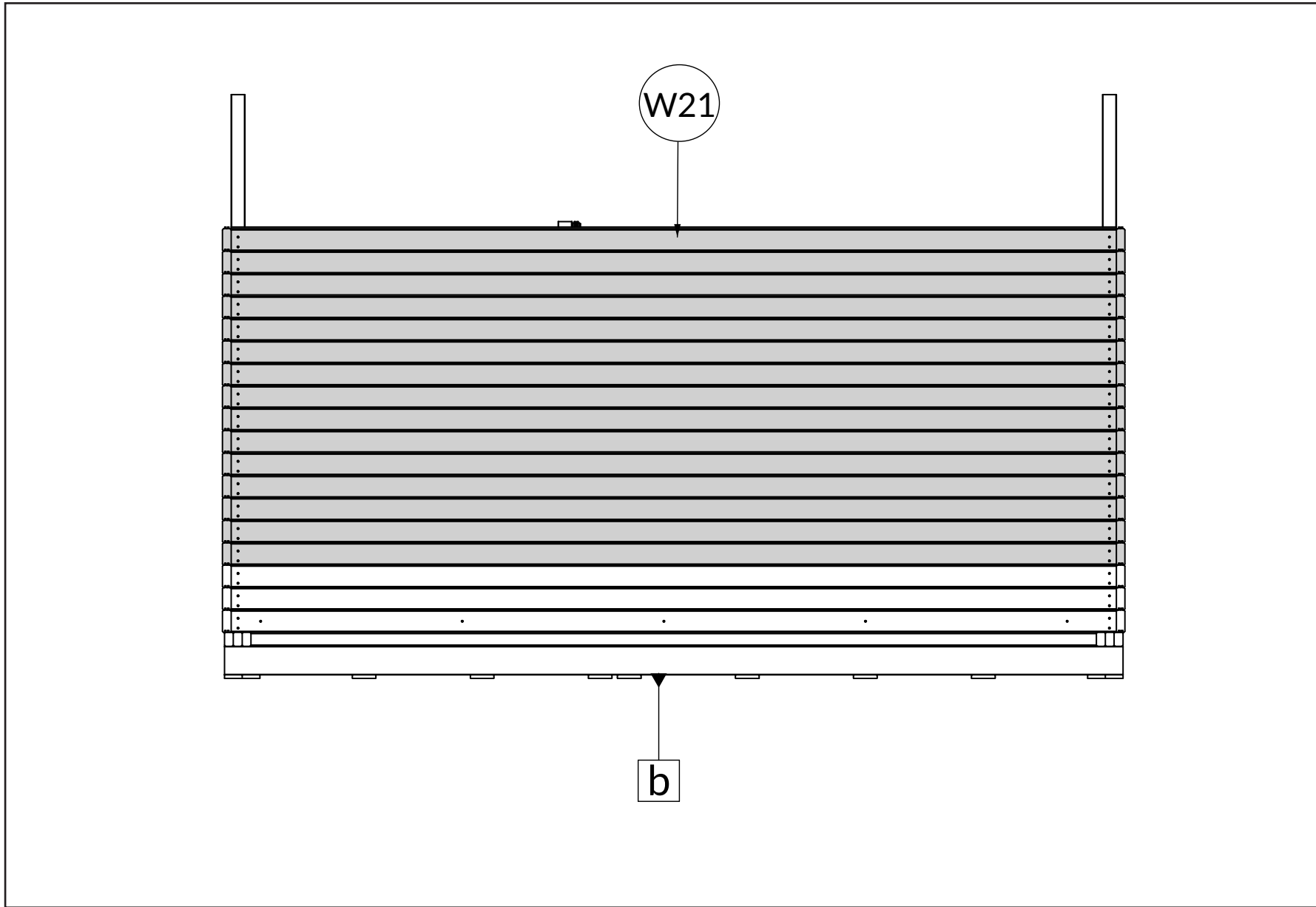

W21 x15

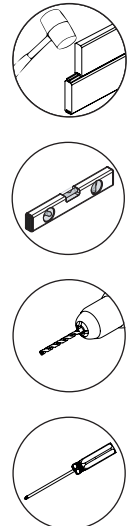
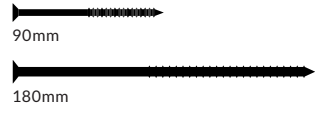

A|1→2→3→4→5→ B|1→2→3→4→5→6→7→8→9→10→11→12→13→14→15→16→17→18→19→20→
 C|1→2→3→4→5→6→7→8→9→ D|1→2→3→4→5→6→7→8→ E|1→2→3→4→5→6→7→
 F|1→2→3→4→5→6→7→ G|1→2→3→ H|1→2→3→ I|1→2→3→4→5→ J|1→2→3→4→

B15.2

A|1→2→3→4→5→ B|1→2→3→4→5→6→7→8→9→10→11→12→13→14→15→16→17→18→19→20→
 C|1→2→3→4→5→6→7→8→9→ D|1→2→3→4→5→6→7→8→ E|1→2→3→4→5→6→7→
 F|1→2→3→4→5→6→7→ G|1→2→3→ H|1→2→3→ I|1→2→3→4→5→ J|1→2→3→4→

B15.3

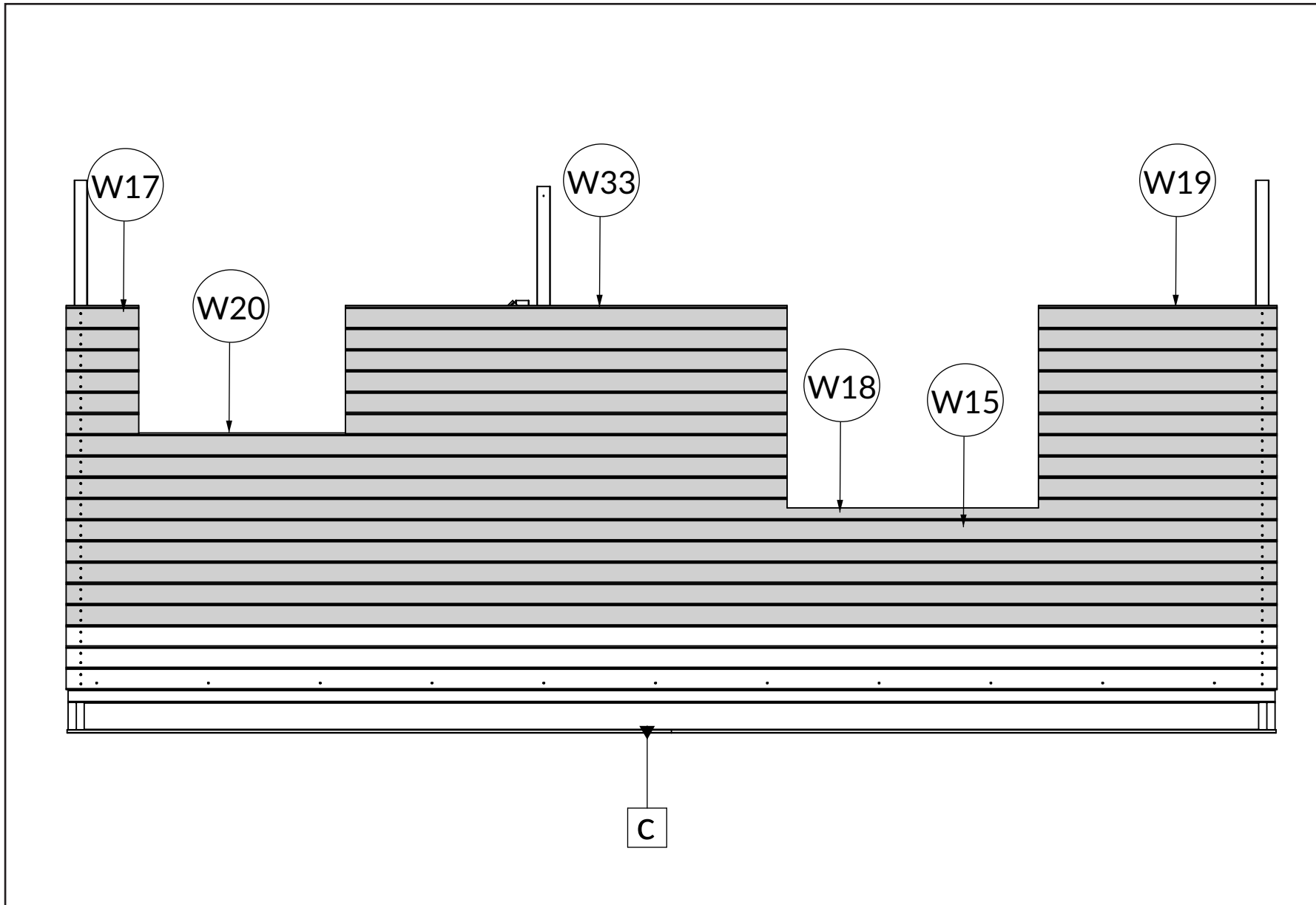

W15 x5

W17 x6

W18 x1

W20 x3

W33 x6

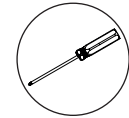
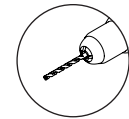
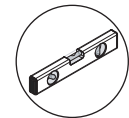
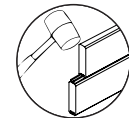

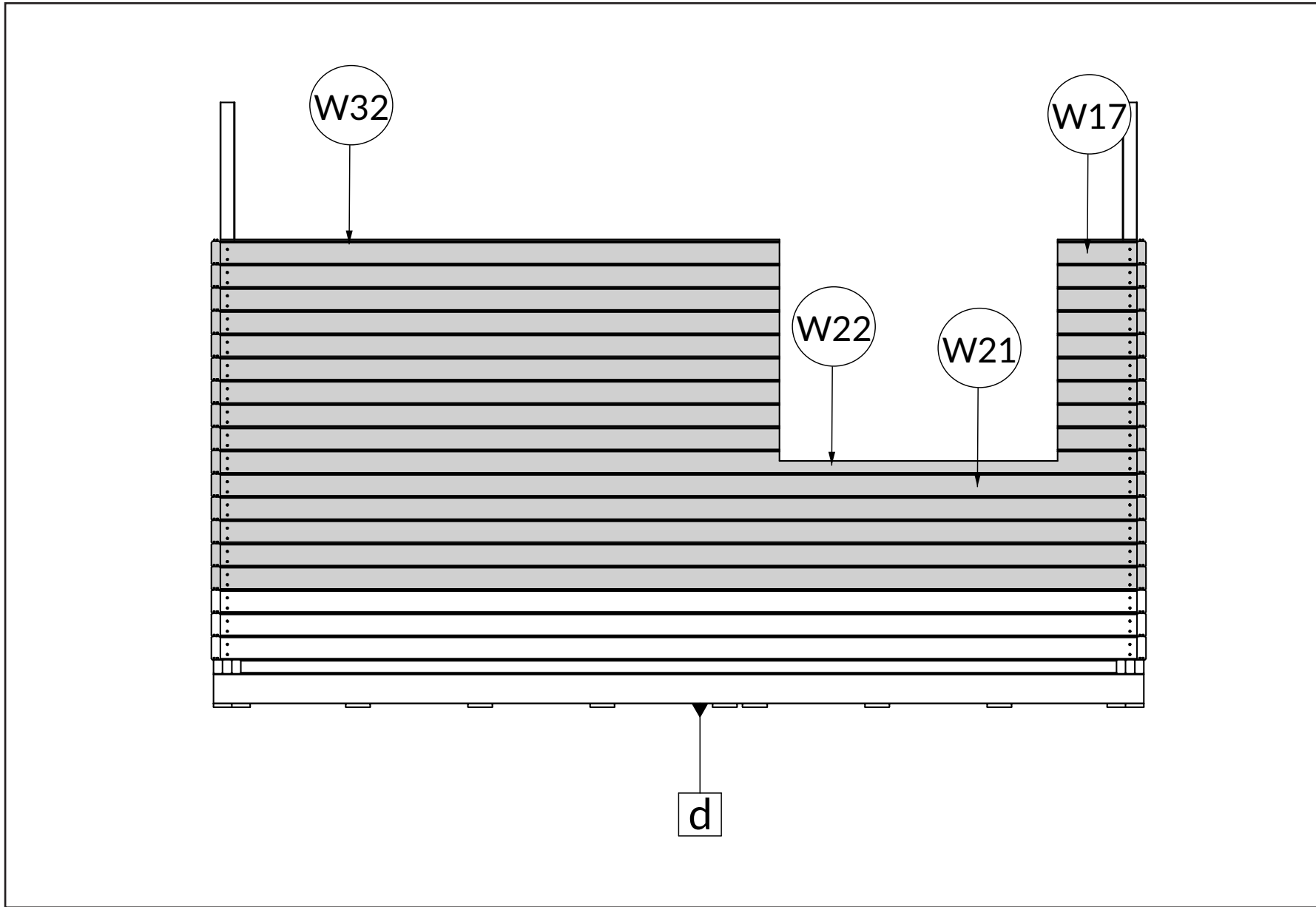

W17 x9

W21 x5

W22 x1

W32 x9

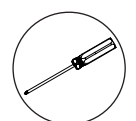
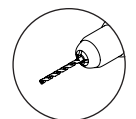
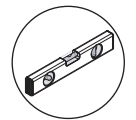
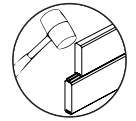

A|1→2→3→4→5→ B|1→2→3→4→5→6→7→8→9→10→11→12→13→14→15→16→17→18→19→20→
 C|1→2→3→4→5→6→7→8→9→ D|1→2→3→4→5→6→7→8→ E|1→2→3→4→5→6→7→
 F|1→2→3→4→5→6→7→ G|1→2→3→ H|1→2→3→ I|1→2→3→4→5→ J|1→2→3→4→

B15.4

A|1→2→3→4→5→ B|1→2→3→4→5→6→7→8→9→10→11→12→13→14→15→16→17→18→19→20→
C|1→2→3→4→5→6→7→8→9→ D|1→2→3→4→5→6→7→8→ E|1→2→3→4→5→6→7→
F|1→2→3→4→5→6→7→ G|1→2→3→ H|1→2→3→ I|1→2→3→4→5→ J|1→2→3→4→

B15.5

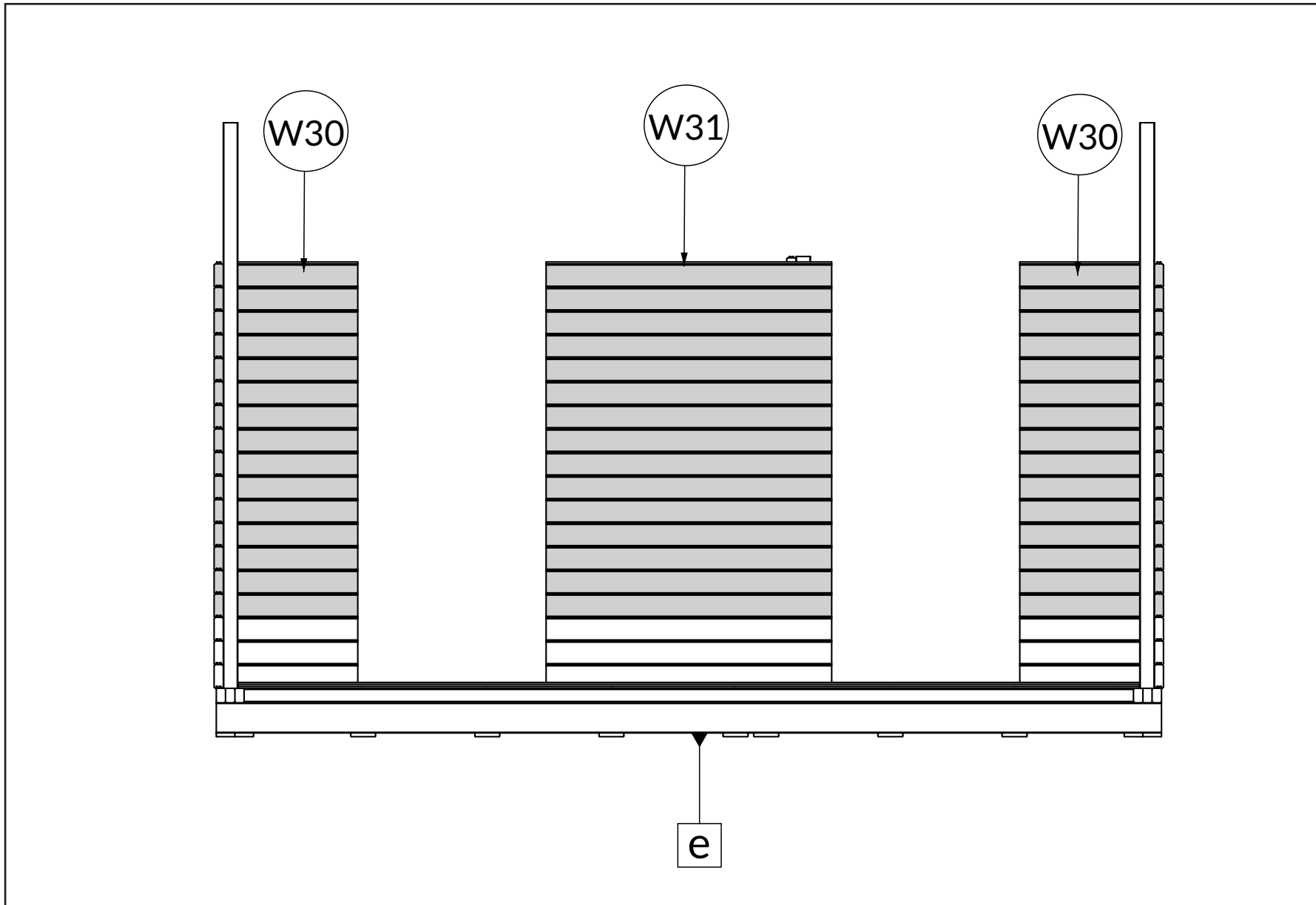

W30 x30

W31 x15

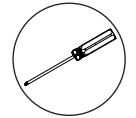
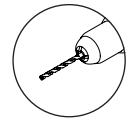
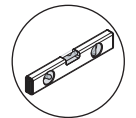
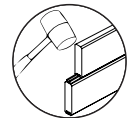

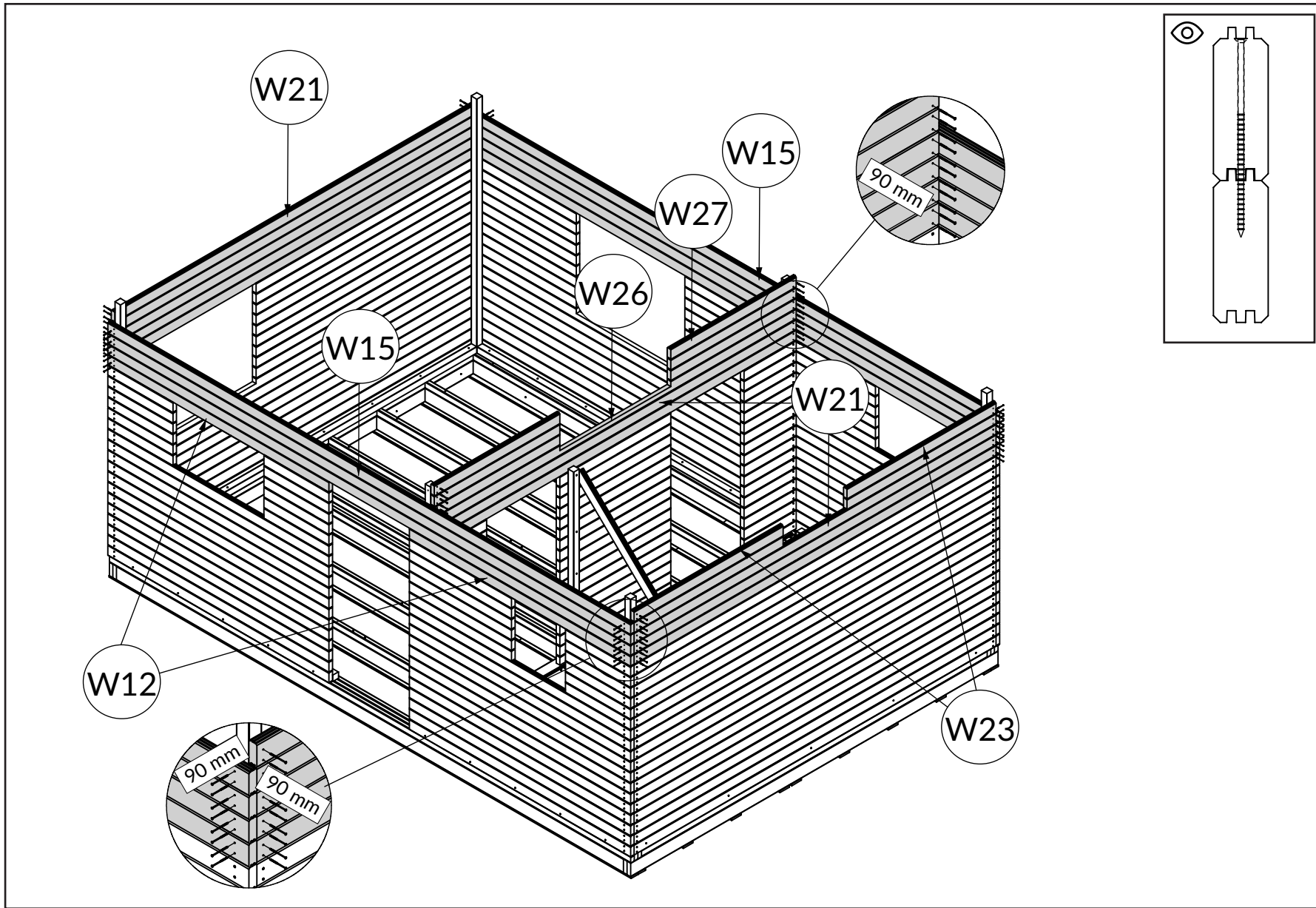

- W12 x2
- W15 x7
- W21 x10
- W23 x4
- W26 x1
- W27 x6

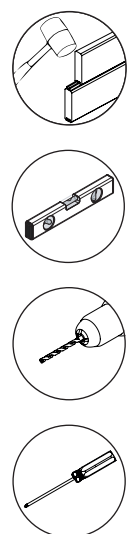
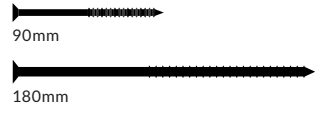

A|1→2→3→4→5→ B|1→2→3→4→5→6→7→8→9→10→11→12→13→14→15→16→17→18→19→20→
 C|1→2→3→4→5→6→7→8→9→ D|1→2→3→4→5→6→7→8→ E|1→2→3→4→5→6→7→
 F|1→2→3→4→5→6→7→ G|1→2→3→ H|1→2→3→ I|1→2→3→4→5→ J|1→2→3→4→

B16

A|1→2→3→4→5→ B|1→2→3→4→5→6→7→8→9→10→11→12→13→14→15→16→17→18→19→20→
C|1→2→3→4→5→6→7→8→9→ D|1→2→3→4→5→6→7→8→ E|1→2→3→4→5→6→7→
F|1→2→3→4→5→6→7→ G|1→2→3→ H|1→2→3→ I|1→2→3→4→5→ J|1→2→3→4→

B17

W29 x2

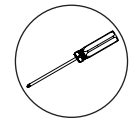
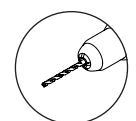
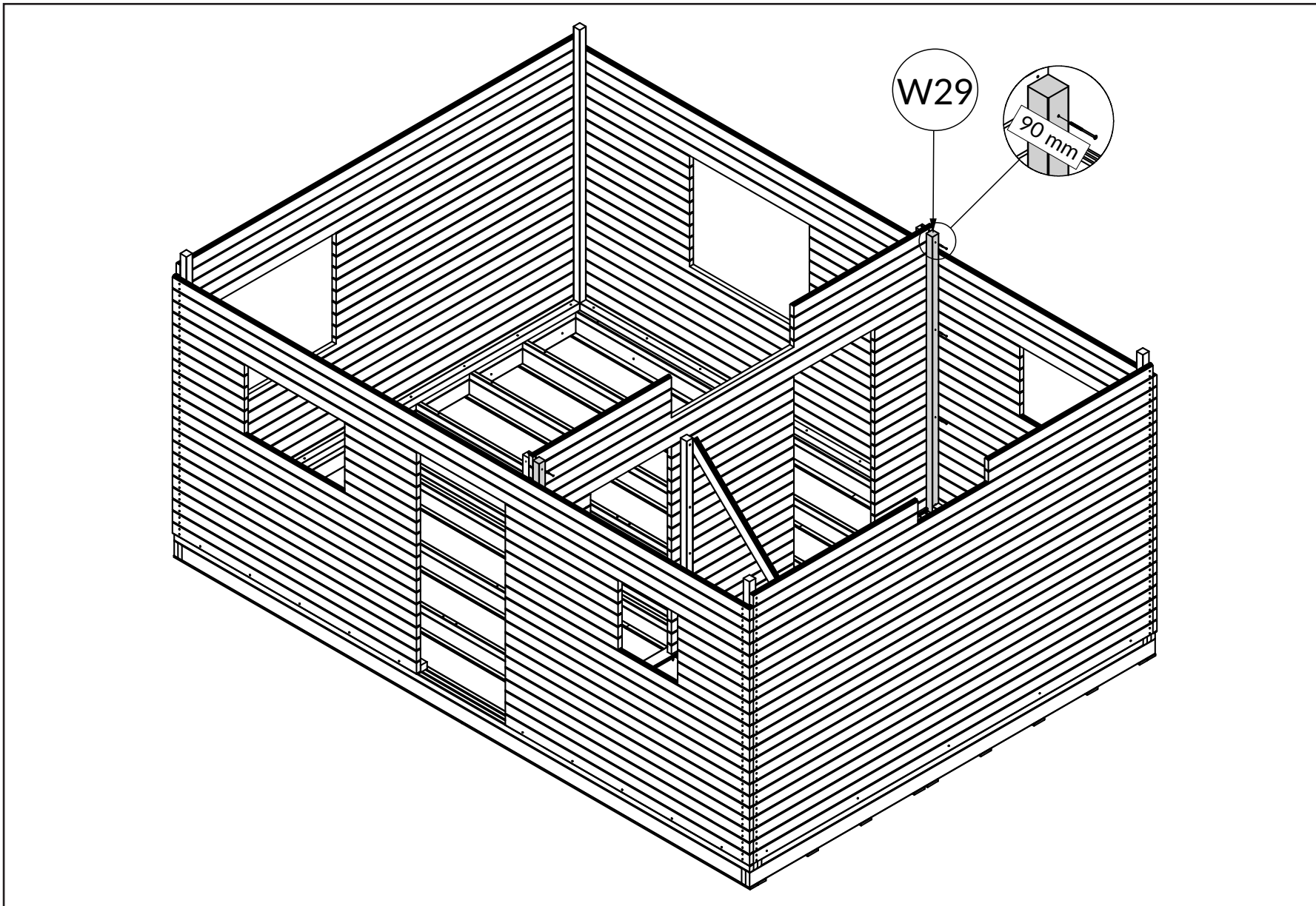

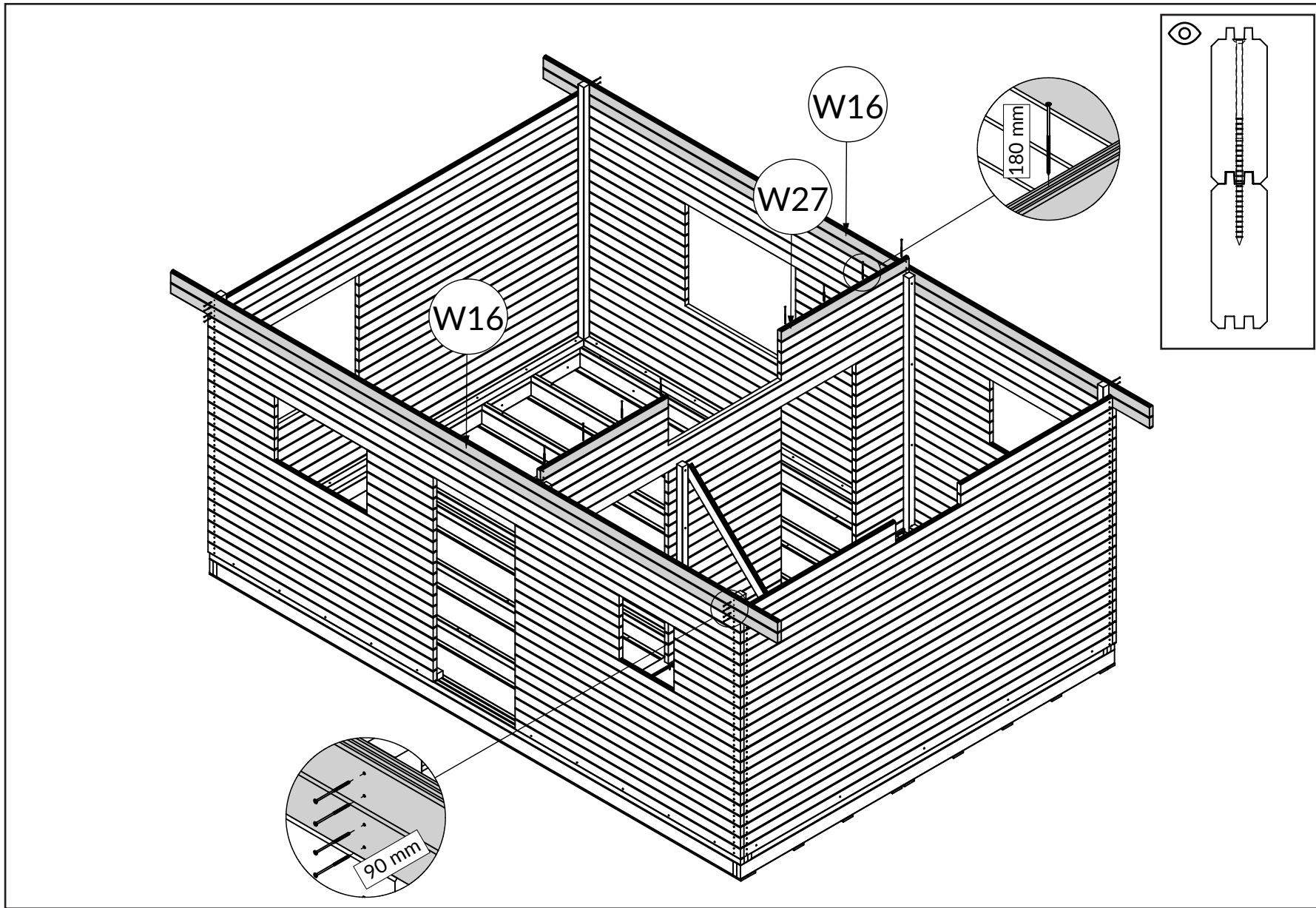

W16 x4

W27 x2

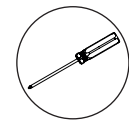
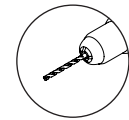
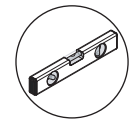
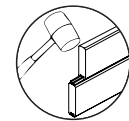
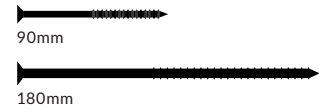

A|1→2→3→4→5→ B|1→2→3→4→5→6→7→8→9→10→11→12→13→14→15→16→17→18→19→20→
 C|1→2→3→4→5→6→7→8→9→ D|1→2→3→4→5→6→7→8→ E|1→2→3→4→5→6→7→
 F|1→2→3→4→5→6→7→ G|1→2→3→ H|1→2→3→ I|1→2→3→4→5→ J|1→2→3→4→

B18

A|1→2→3→4→5→ B|1→2→3→4→5→6→7→8→9→10→11→12→13→14→15→16→17→18→19→20→
C|1→2→3→4→5→6→7→8→9→ D|1→2→3→4→5→6→7→8→ E|1→2→3→4→5→6→7→
F|1→2→3→4→5→6→7→ G|1→2→3→ H|1→2→3→ I|1→2→3→4→5→ J|1→2→3→4→

B19

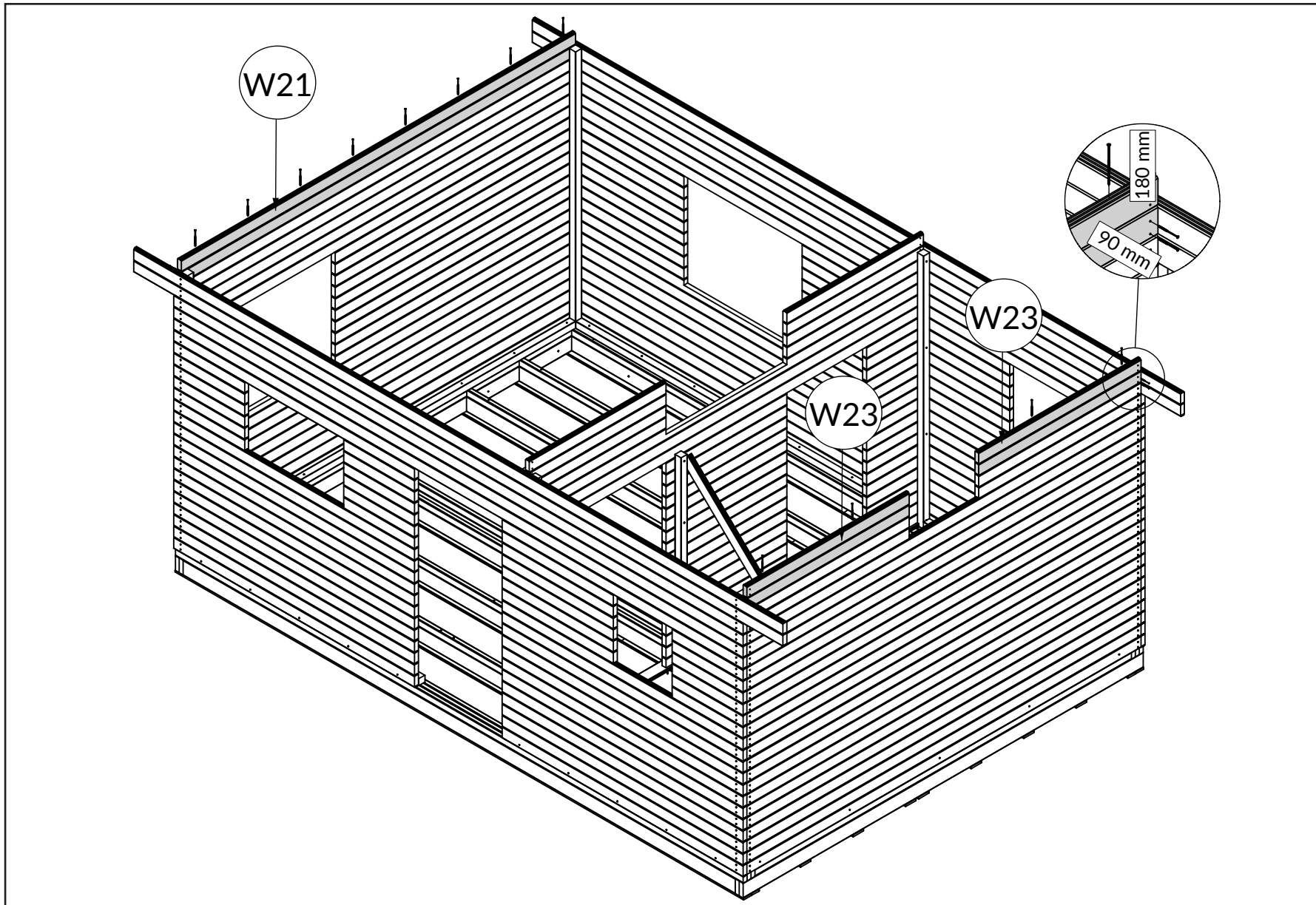

W21 x2

W23 x4

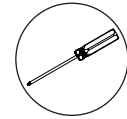
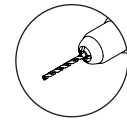
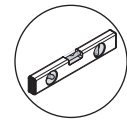
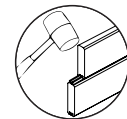
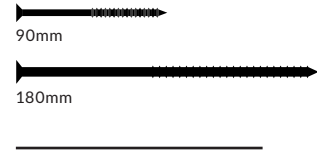

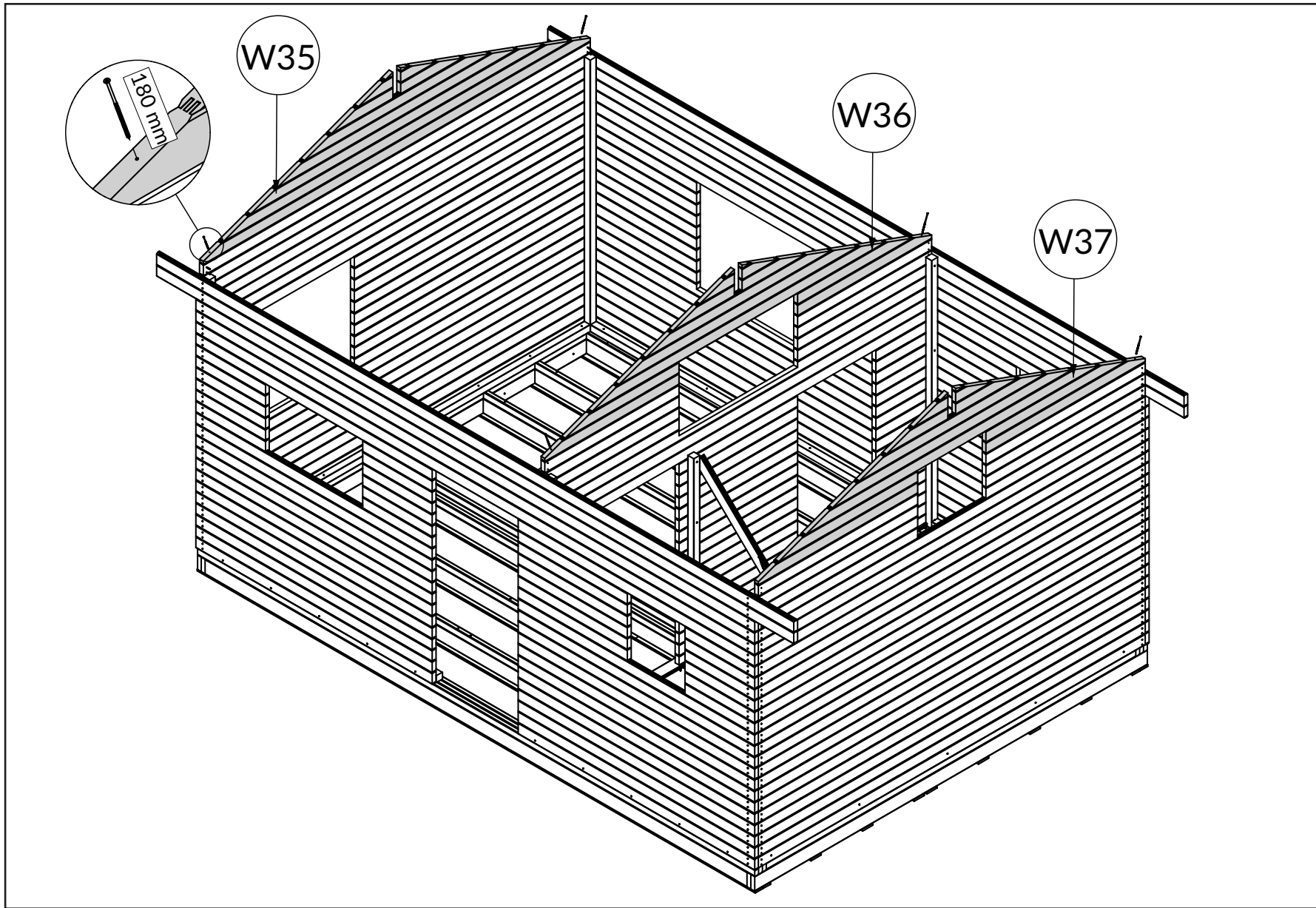

- W35 x1
- W36 x1
- W37 x1

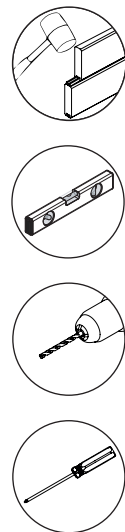

A|1→2→3→4→5→ B|1→2→3→4→5→6→7→8→9→10→11→12→13→14→15→16→17→18→19→20→
 C|1→2→3→4→5→6→7→8→9→ D|1→2→3→4→5→6→7→8→ E|1→2→3→4→5→6→7→
 F|1→2→3→4→5→6→7→ G|1→2→3→ H|1→2→3→ I|1→2→3→4→5→ J|1→2→3→4→

B20

C

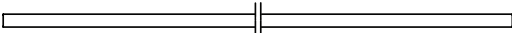
W38 
x2 (70x45) x 4360mm (VT1)

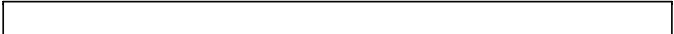
W39 
x5 (146x44) x 2440mm (VT2)

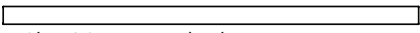
W28 
x1 (70x70) x 2061mm (P1)

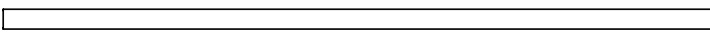
W11 
x2 (70x70) x 3136mm (PT2)

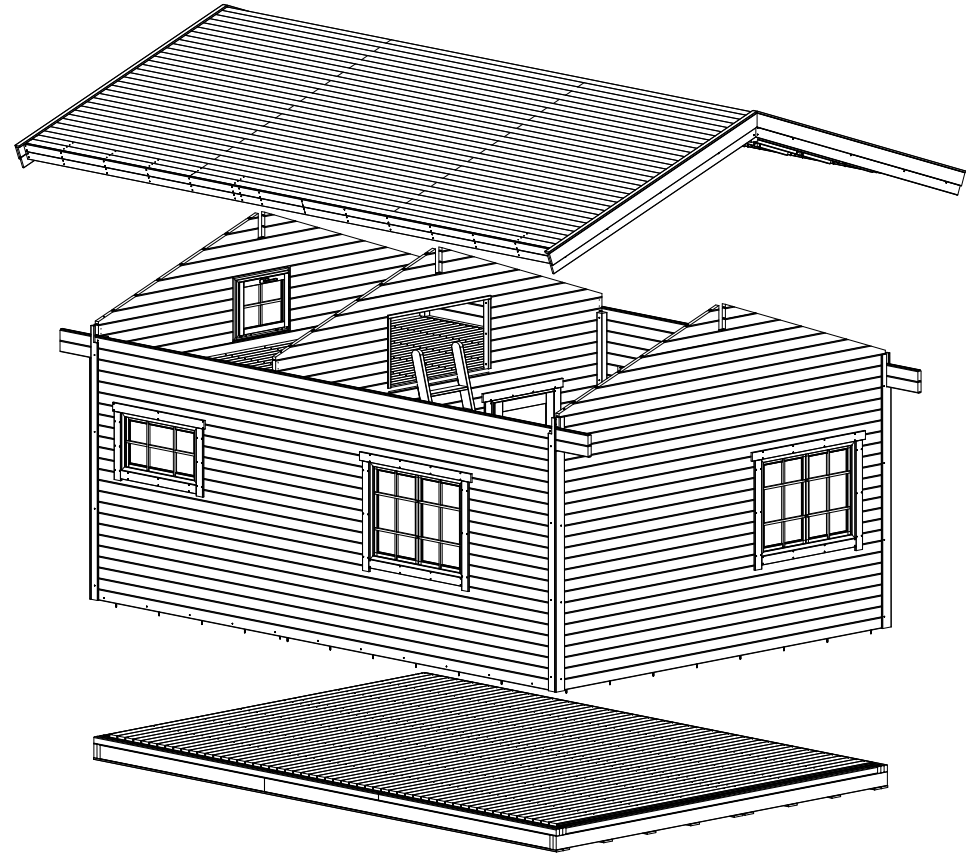
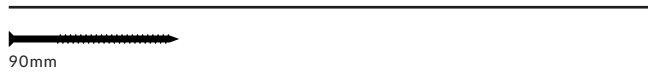



V-1

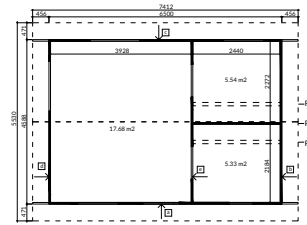

e	P1	W38		x2	W38.1	W38.2
	P2	W38		x2	W38.3	W38.4
	P3	W38		x2	W38.5	W38.6

V-1



A|1→2→3→4→5→ B|1→2→3→4→5→6→7→8→9→10→11→12→13→14→15→16→17→18→19→20→
 C|1→2→3→4→5→6→7→8→9→ D|1→2→3→4→5→6→7→8→ E|1→2→3→4→5→6→7→
 F|1→2→3→4→5→6→7→ G|1→2→3→ H|1→2→3→ I|1→2→3→4→5→ J|1→2→3→4→

C1

C2

A|1→2→3→4→5→ B|1→2→3→4→5→6→7→8→9→10→11→12→13→14→15→16→17→18→19→20→
C|1→2→3→4→5→6→7→8→9→ D|1→2→3→4→5→6→7→8→ E|1→2→3→4→5→6→7→
F|1→2→3→4→5→6→7→ G|1→2→3→ H|1→2→3→ I|1→2→3→4→5→ J|1→2→3→4→

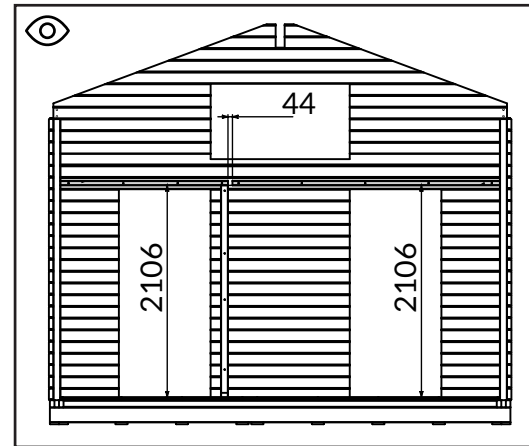
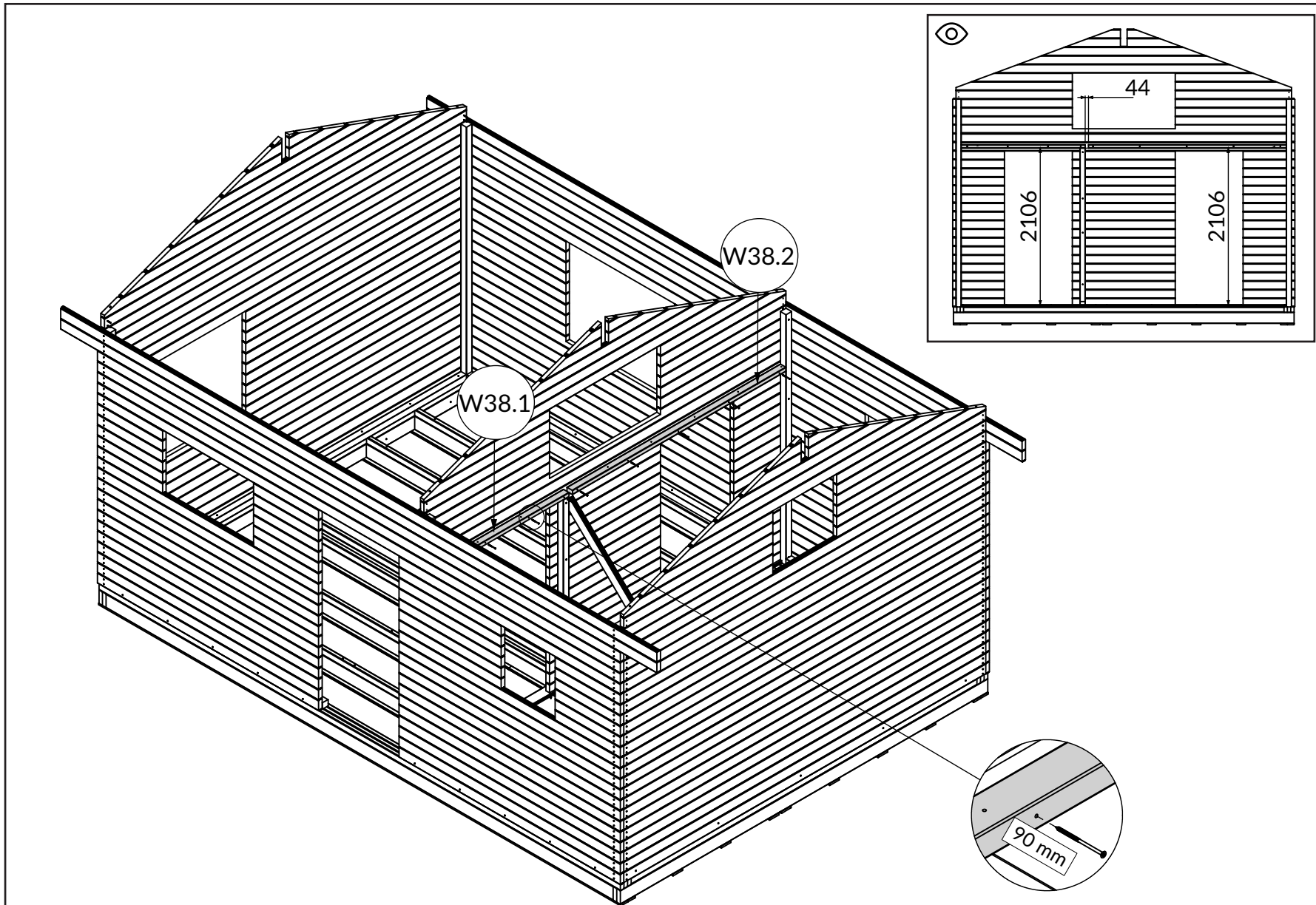

W38.1 x1

W38.2 x1

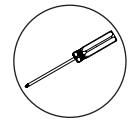
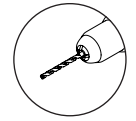
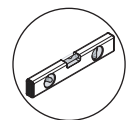

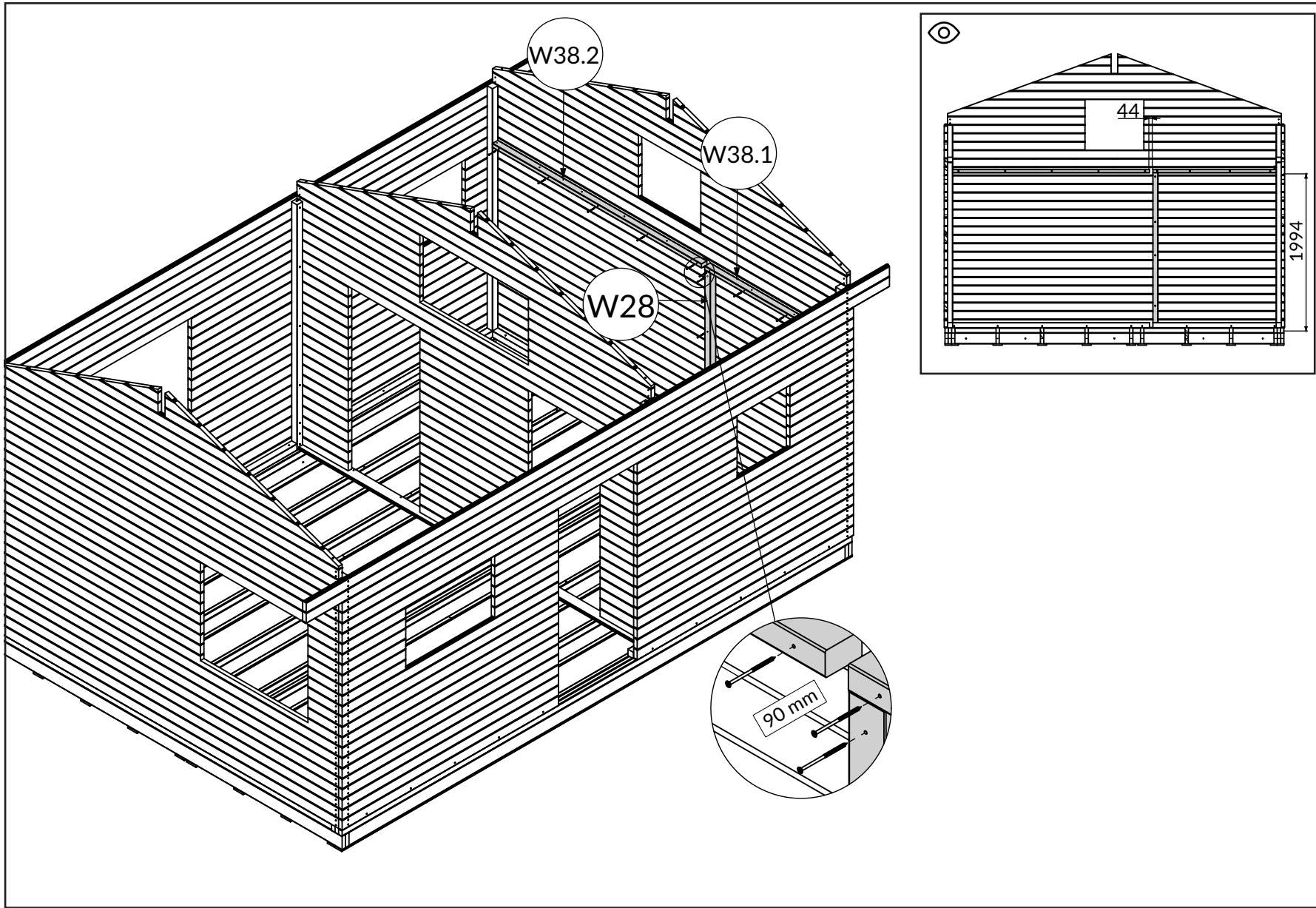

W38.1 x1

W38.1 x1

W28 x1

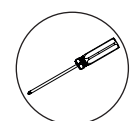
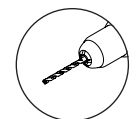
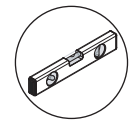

A|1→2→3→4→5→ B|1→2→3→4→5→6→7→8→9→10→11→12→13→14→15→16→17→18→19→20→
 C|1→2→3→4→5→6→7→8→9→ D|1→2→3→4→5→6→7→8→ E|1→2→3→4→5→6→7→
 F|1→2→3→4→5→6→7→ G|1→2→3→ H|1→2→3→ I|1→2→3→4→5→ J|1→2→3→4→

C3

A|1→2→3→4→5→ B|1→2→3→4→5→6→7→8→9→10→11→12→13→14→15→16→17→18→19→20→
 C|1→2→3→4→5→6→7→8→9→ D|1→2→3→4→5→6→7→8→ E|1→2→3→4→5→6→7→
 F|1→2→3→4→5→6→7→ G|1→2→3→ H|1→2→3→ I|1→2→3→4→5→ J|1→2→3→4→

C4



V-1

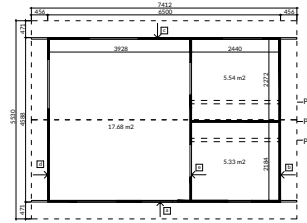

V-1

e	V-1	(W11)		x2	(W11.8)
	V-2	(W11)		x2	(W11.9)

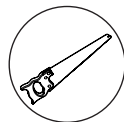

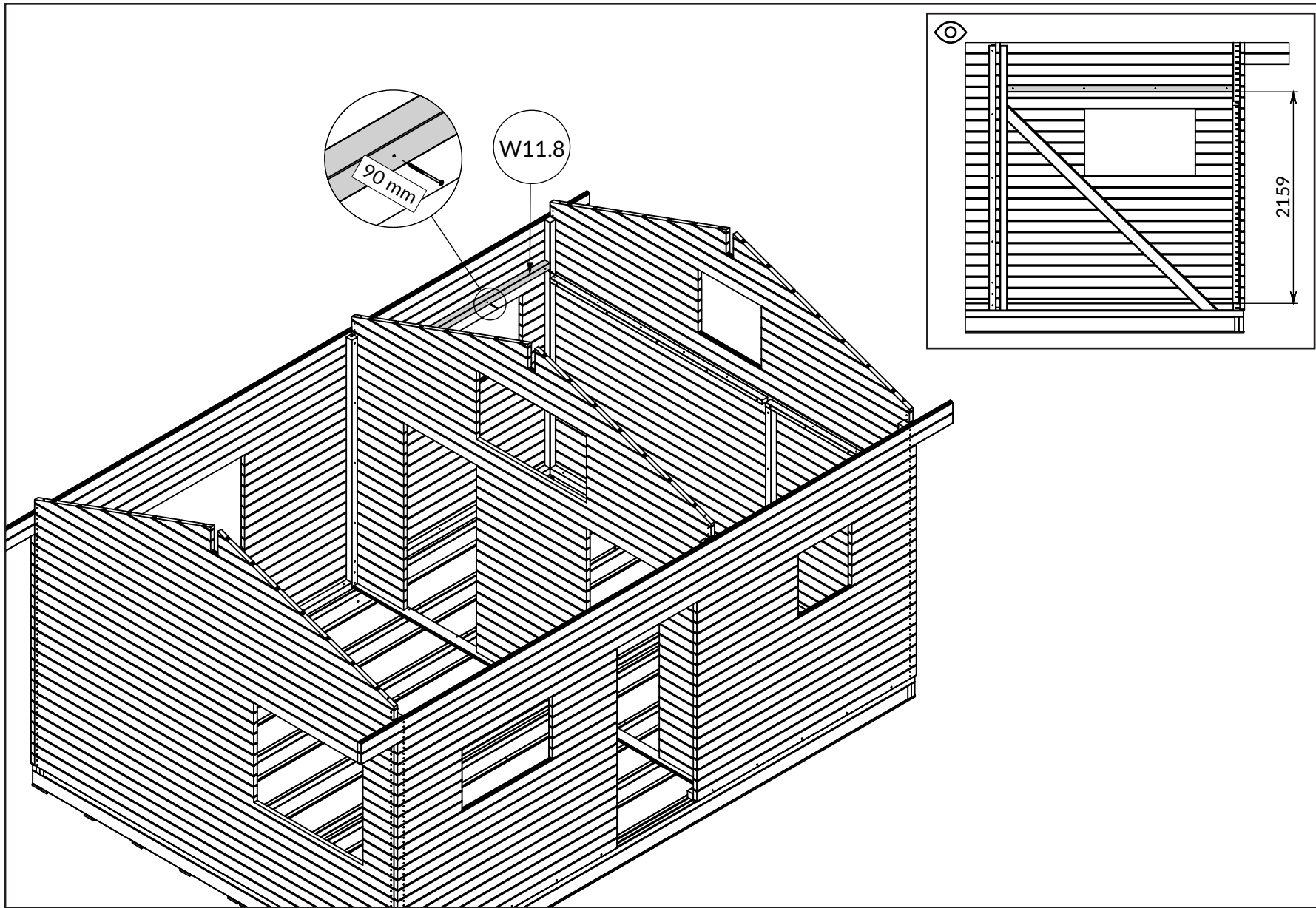

W11.8 x1

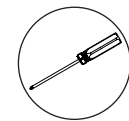
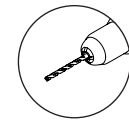
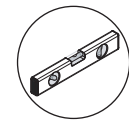
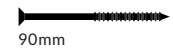

A|1→2→3→4→5→ B|1→2→3→4→5→6→7→8→9→10→11→12→13→14→15→16→17→18→19→20→
 C|1→2→3→4→5→6→7→8→9→ D|1→2→3→4→5→6→7→8→ E|1→2→3→4→5→6→7→
 F|1→2→3→4→5→6→7→ G|1→2→3→ H|1→2→3→ I|1→2→3→4→5→ J|1→2→3→4→

C5

C6

A|1→2→3→4→5→ B|1→2→3→4→5→6→7→8→9→10→11→12→13→14→15→16→17→18→19→20→
C|1→2→3→4→5→6→7→8→9→ D|1→2→3→4→5→6→7→8→ E|1→2→3→4→5→6→7→
F|1→2→3→4→5→6→7→ G|1→2→3→ H|1→2→3→ I|1→2→3→4→5→ J|1→2→3→4→

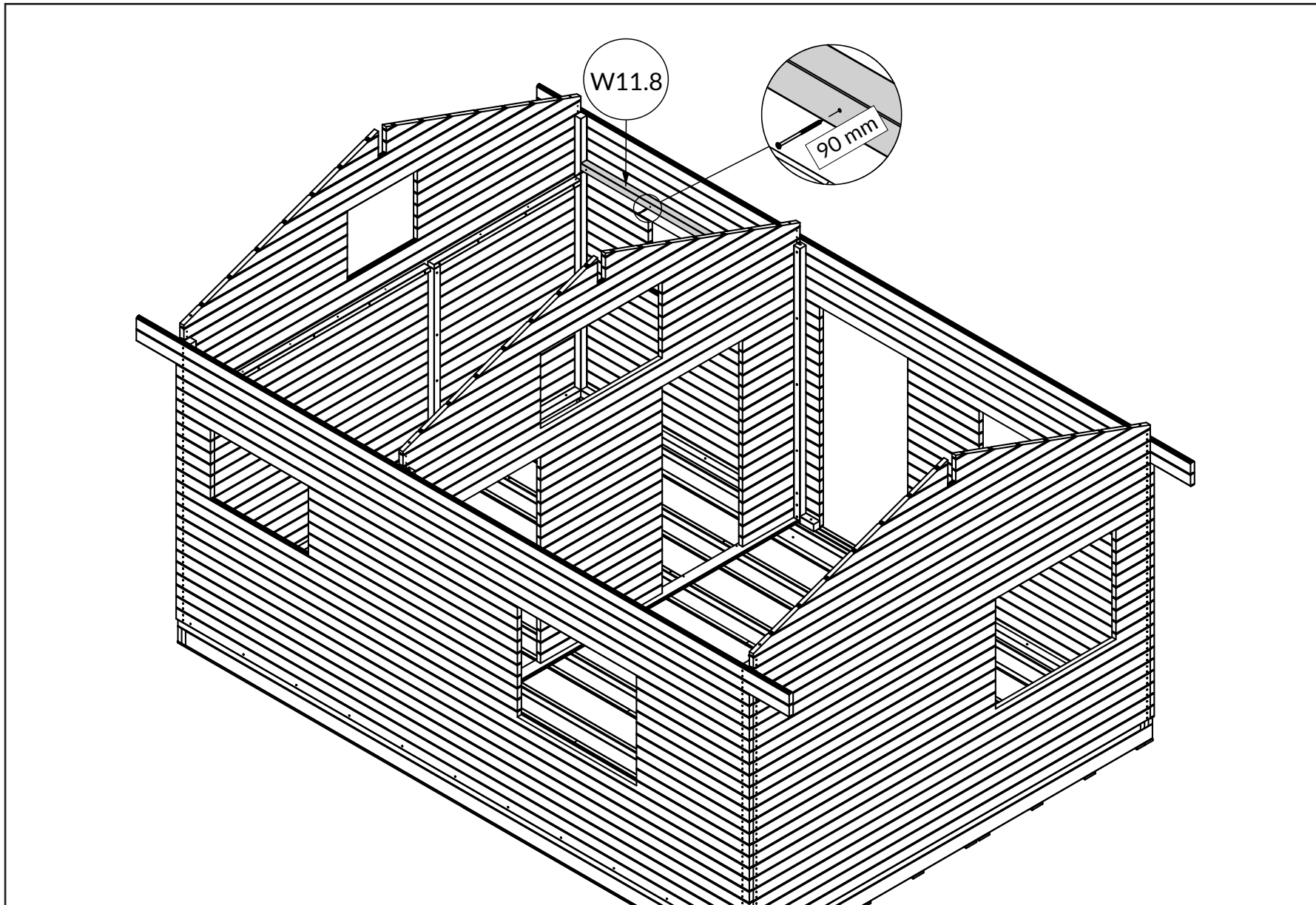

W11.8 x1

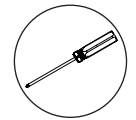
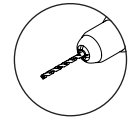
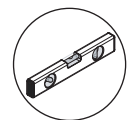



V-1

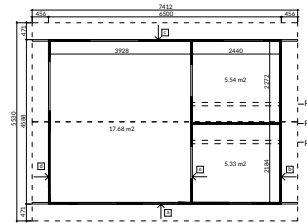

V-1

e	V-1	W39	← 2440 →	x9	W39.1
	V-2	W39	← 1841 → ← 2440 →	x9	W39.2



A|1→2→3→4→5→ B|1→2→3→4→5→6→7→8→9→10→11→12→13→14→15→16→17→18→19→20→
 C|1→2→3→4→5→6→7→8→9→ D|1→2→3→4→5→6→7→8→ E|1→2→3→4→5→6→7→
 F|1→2→3→4→5→6→7→ G|1→2→3→ H|1→2→3→ I|1→2→3→4→5→ J|1→2→3→4→

C7

A|1→2→3→4→5→ B|1→2→3→4→5→6→7→8→9→10→11→12→13→14→15→16→17→18→19→20→
C|1→2→3→4→5→6→7→8→9→ D|1→2→3→4→5→6→7→8→ E|1→2→3→4→5→6→7→
F|1→2→3→4→5→6→7→ G|1→2→3→ H|1→2→3→ I|1→2→3→4→5→ J|1→2→3→4→

C8

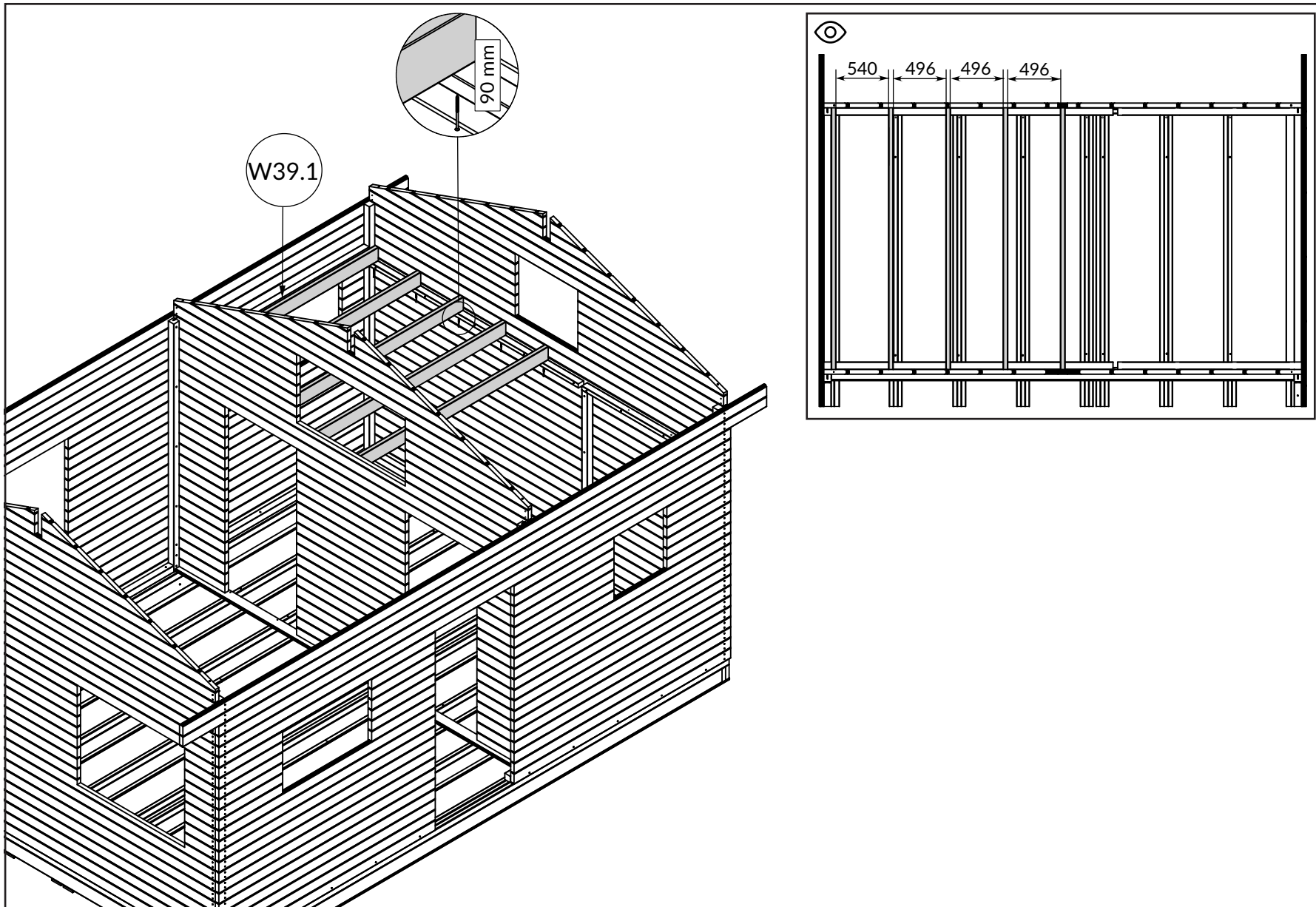

W39.1 x9

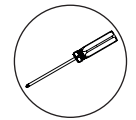
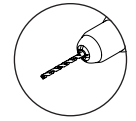
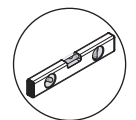

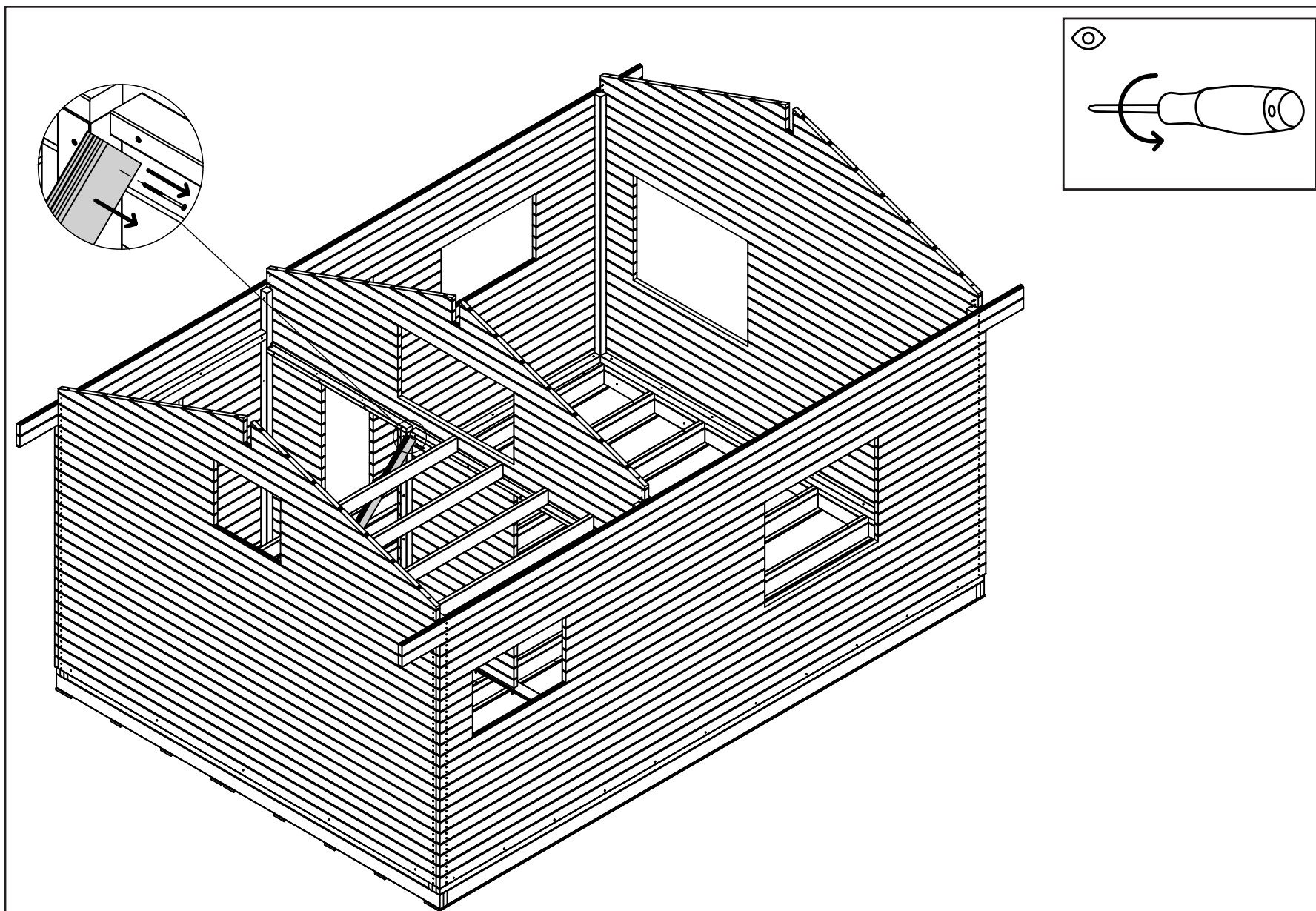

A|1→2→3→4→5→ B|1→2→3→4→5→6→7→8→9→10→11→12→13→14→15→16→17→18→19→20→
 C|1→2→3→4→5→6→7→8→9→ D|1→2→3→4→5→6→7→8→ E|1→2→3→4→5→6→7→
 F|1→2→3→4→5→6→7→ G|1→2→3→ H|1→2→3→ I|1→2→3→4→5→ J|1→2→3→4→

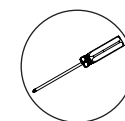

C9

D

D

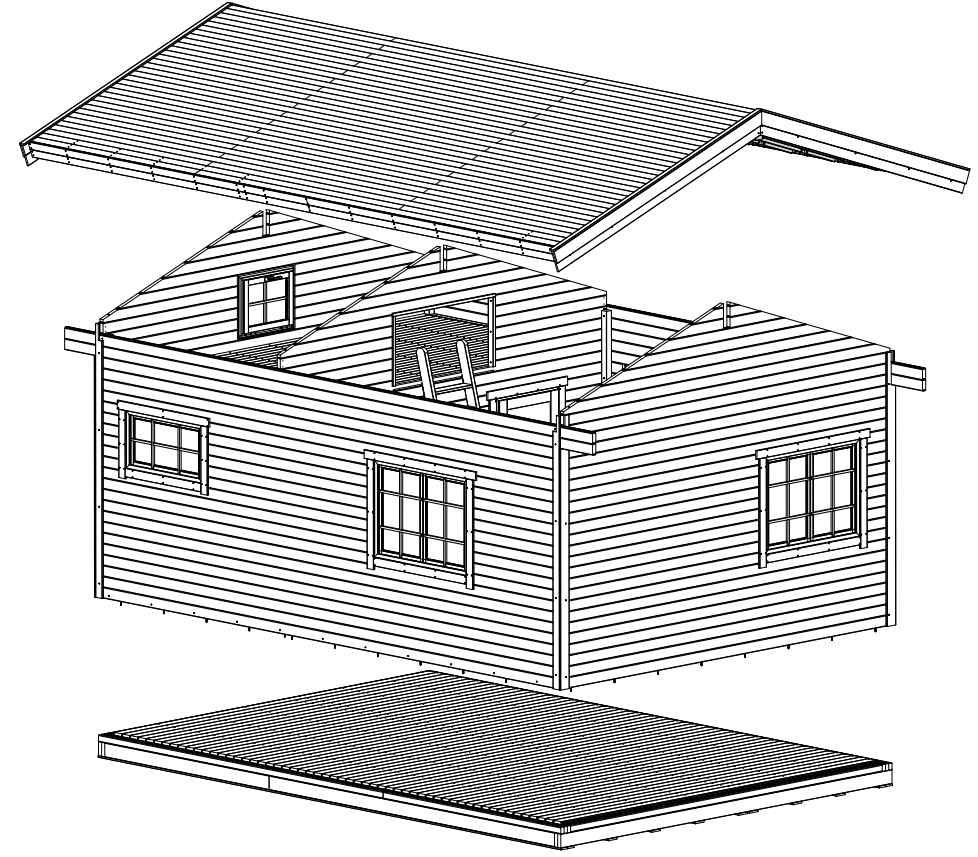
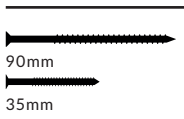
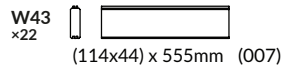
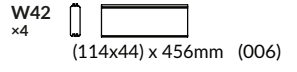
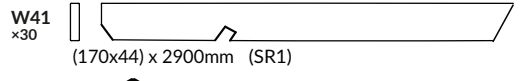
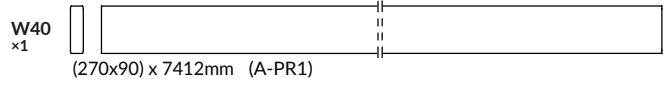

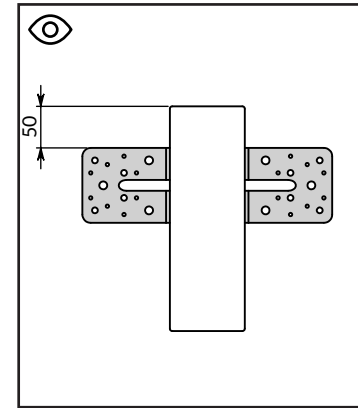
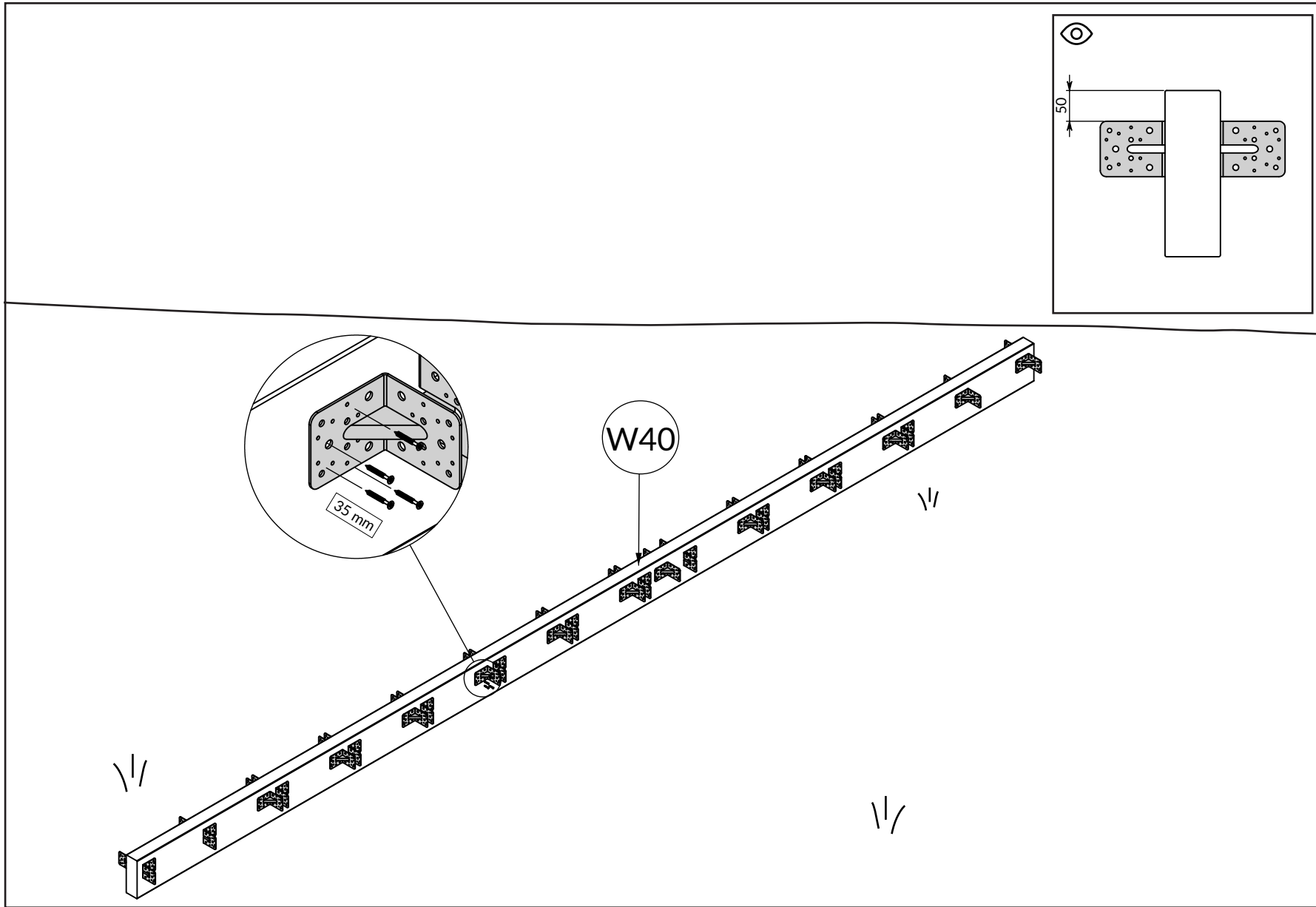

W40 x1

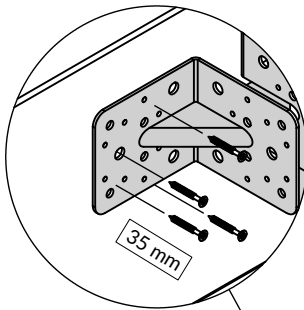

W40



x48



A|1→2→3→4→5→ B|1→2→3→4→5→6→7→8→9→10→11→12→13→14→15→16→17→18→19→20→
 C|1→2→3→4→5→6→7→8→9→ D|1→2→3→4→5→6→7→8→ E|1→2→3→4→5→6→7→
 F|1→2→3→4→5→6→7→ G|1→2→3→ H|1→2→3→ I|1→2→3→4→5→ J|1→2→3→4→

D1

A|1→2→3→4→5→ B|1→2→3→4→5→6→7→8→9→10→11→12→13→14→15→16→17→18→19→20→
 C|1→2→3→4→5→6→7→8→9→ D|1→2→3→4→5→6→7→8→ E|1→2→3→4→5→6→7→
 F|1→2→3→4→5→6→7→ G|1→2→3→ H|1→2→3→ I|1→2→3→4→5→ J|1→2→3→4→

D1.1

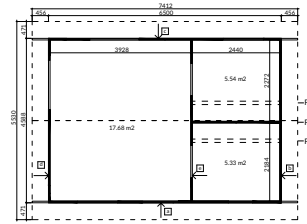

V-1

W40 x1



x48

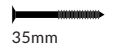

35mm

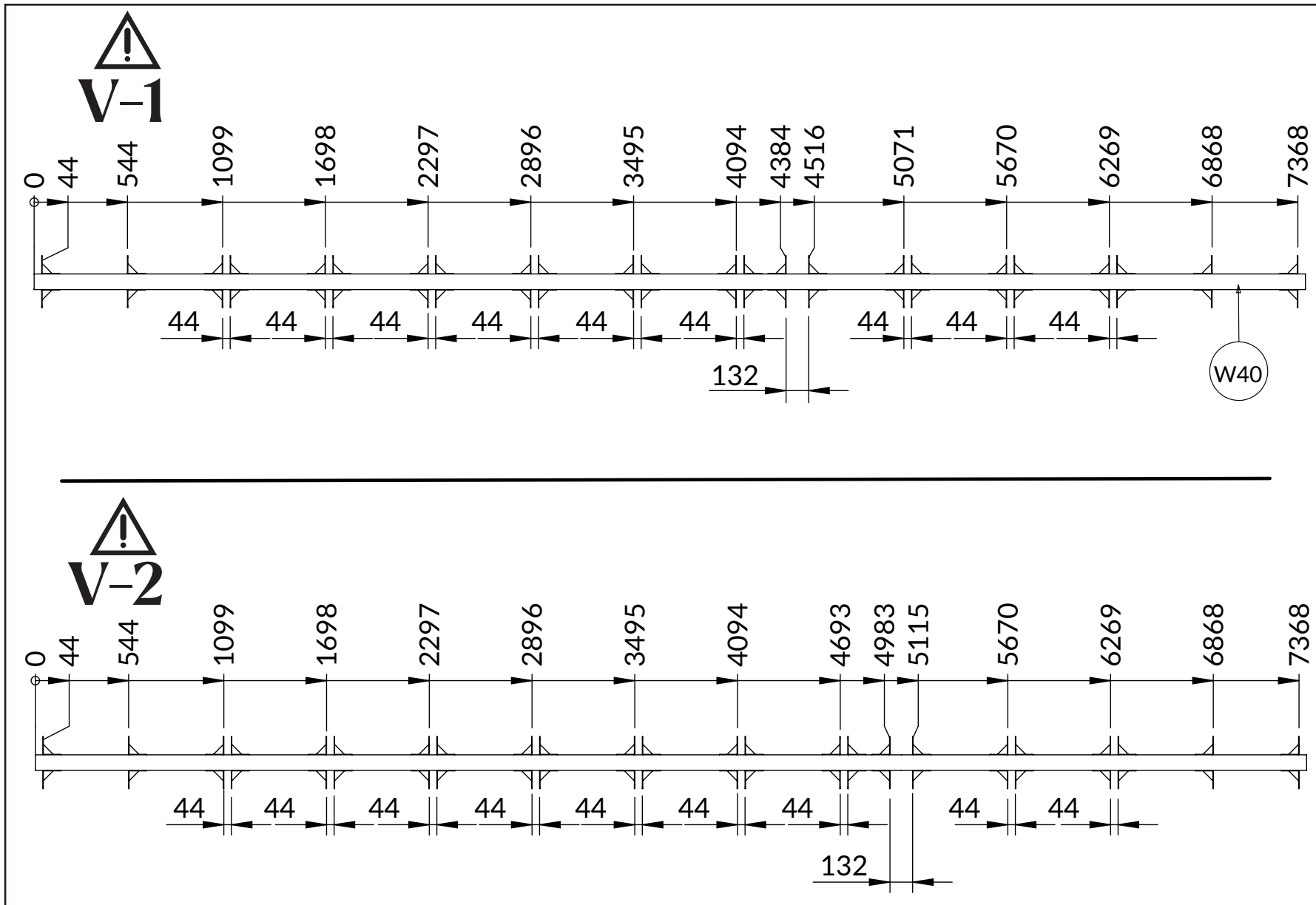
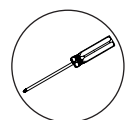
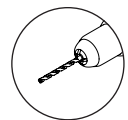
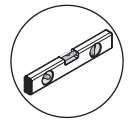

W40 x1

W40

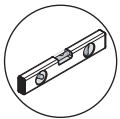
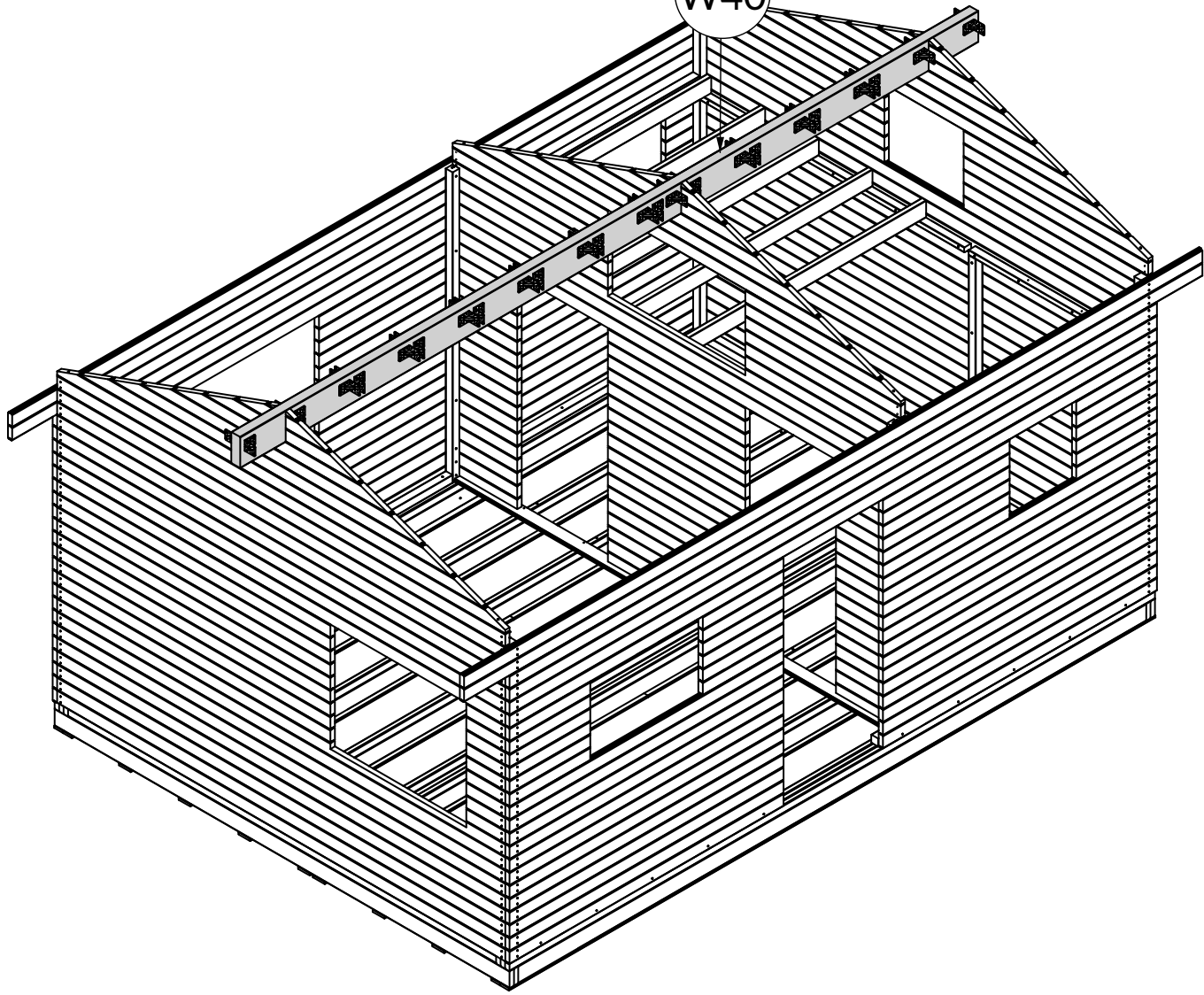

A|1→2→3→4→5→ B|1→2→3→4→5→6→7→8→9→10→11→12→13→14→15→16→17→18→19→20→
 C|1→2→3→4→5→6→7→8→9→ D|1→2→3→4→5→6→7→8→ E|1→2→3→4→5→6→7→
 F|1→2→3→4→5→6→7→ G|1→2→3→ H|1→2→3→ I|1→2→3→4→5→ J|1→2→3→4→

D2

D3

A|1→2→3→4→5→ B|1→2→3→4→5→6→7→8→9→10→11→12→13→14→15→16→17→18→19→20→
C|1→2→3→4→5→6→7→8→9→ D|1→2→3→4→5→6→7→8→ E|1→2→3→4→5→6→7→
F|1→2→3→4→5→6→7→ G|1→2→3→ H|1→2→3→ I|1→2→3→4→5→ J|1→2→3→4→

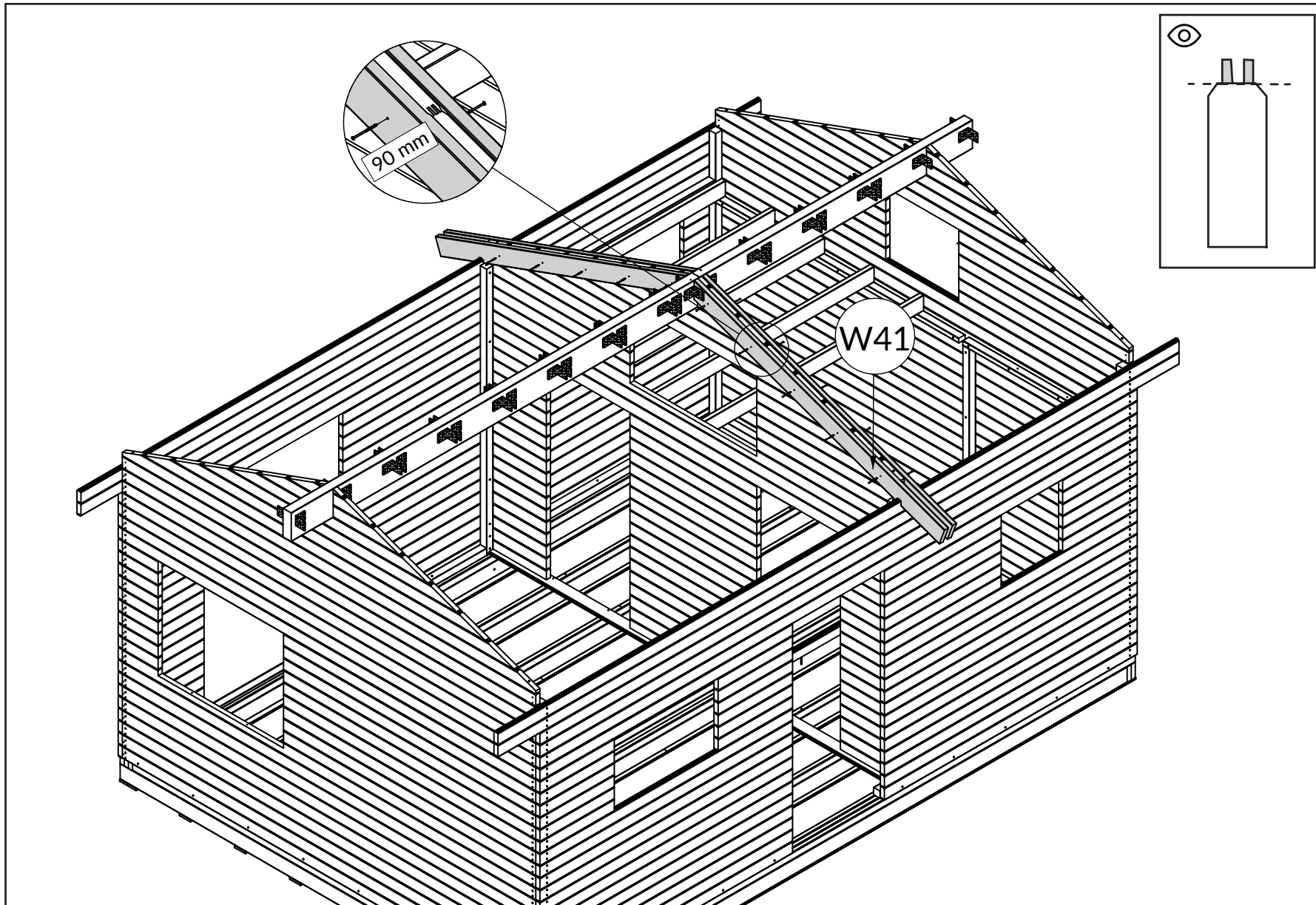

W41 x4

90mm

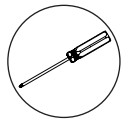
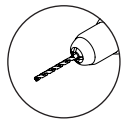

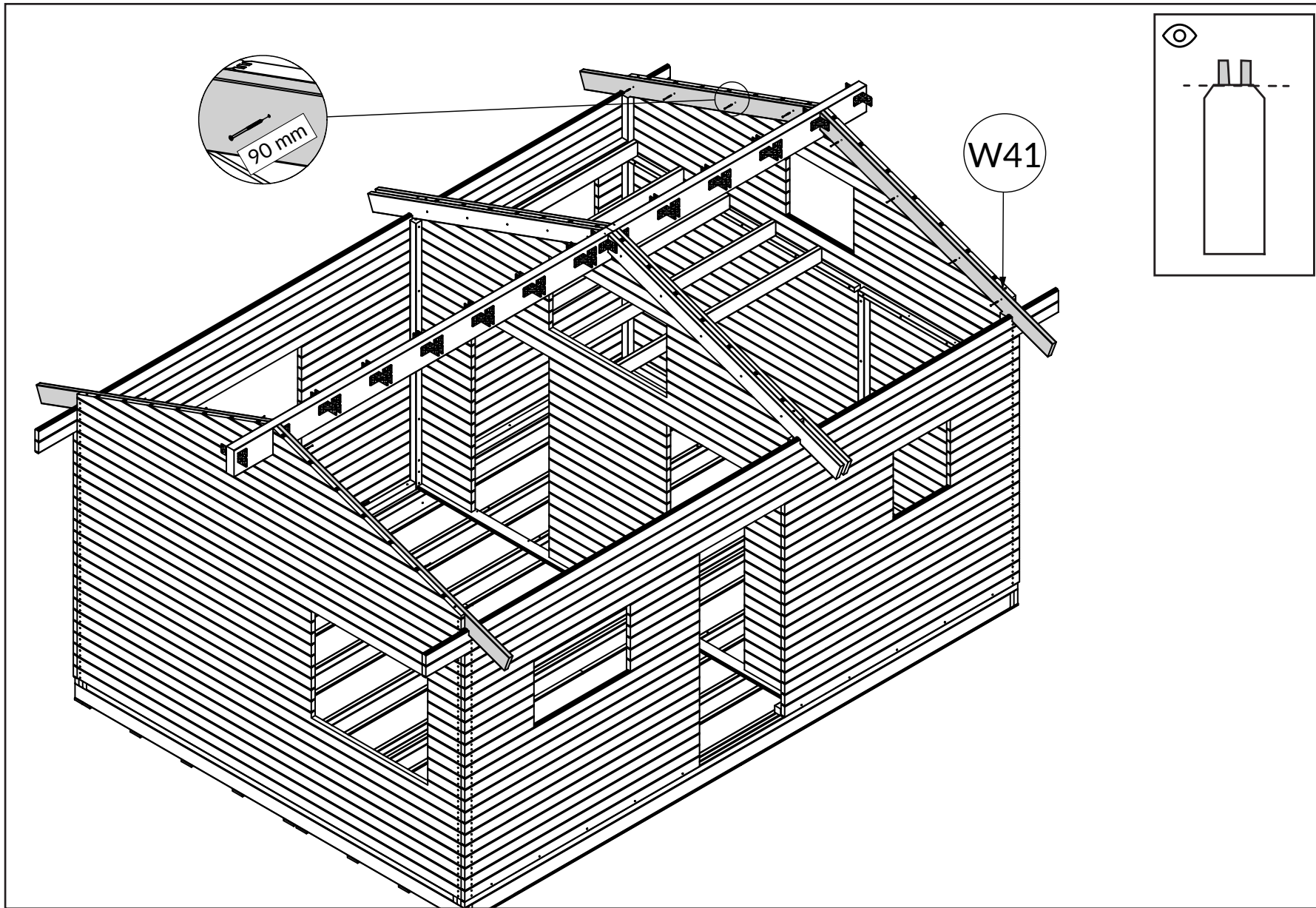

W41 x4

W41

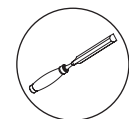
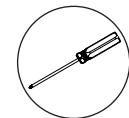
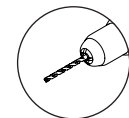
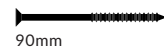

A|1→2→3→4→5→ B|1→2→3→4→5→6→7→8→9→10→11→12→13→14→15→16→17→18→19→20→
 C|1→2→3→4→5→6→7→8→9→ D|1→2→3→4→5→6→7→8→ E|1→2→3→4→5→6→7→
 F|1→2→3→4→5→6→7→ G|1→2→3→ H|1→2→3→ I|1→2→3→4→5→ J|1→2→3→4→

D4

A|1→2→3→4→5→ B|1→2→3→4→5→6→7→8→9→10→11→12→13→14→15→16→17→18→19→20→
C|1→2→3→4→5→6→7→8→9→ D|1→2→3→4→5→6→7→8→ E|1→2→3→4→5→6→7→
F|1→2→3→4→5→6→7→ G|1→2→3→ H|1→2→3→ I|1→2→3→4→5→ J|1→2→3→4→

D5

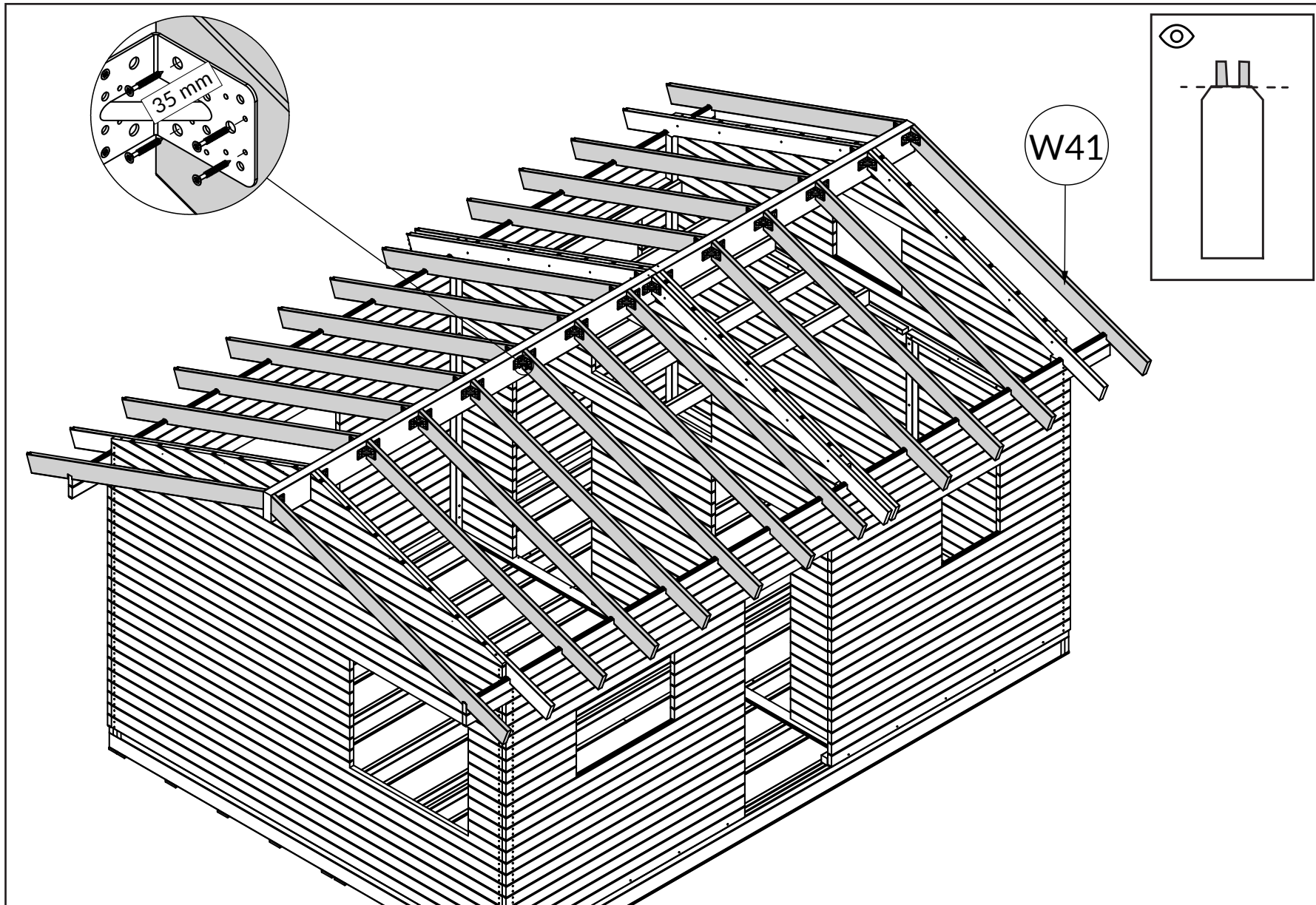

W41 x22

W41

35mm



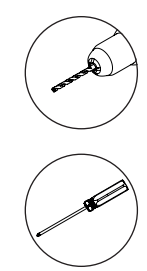
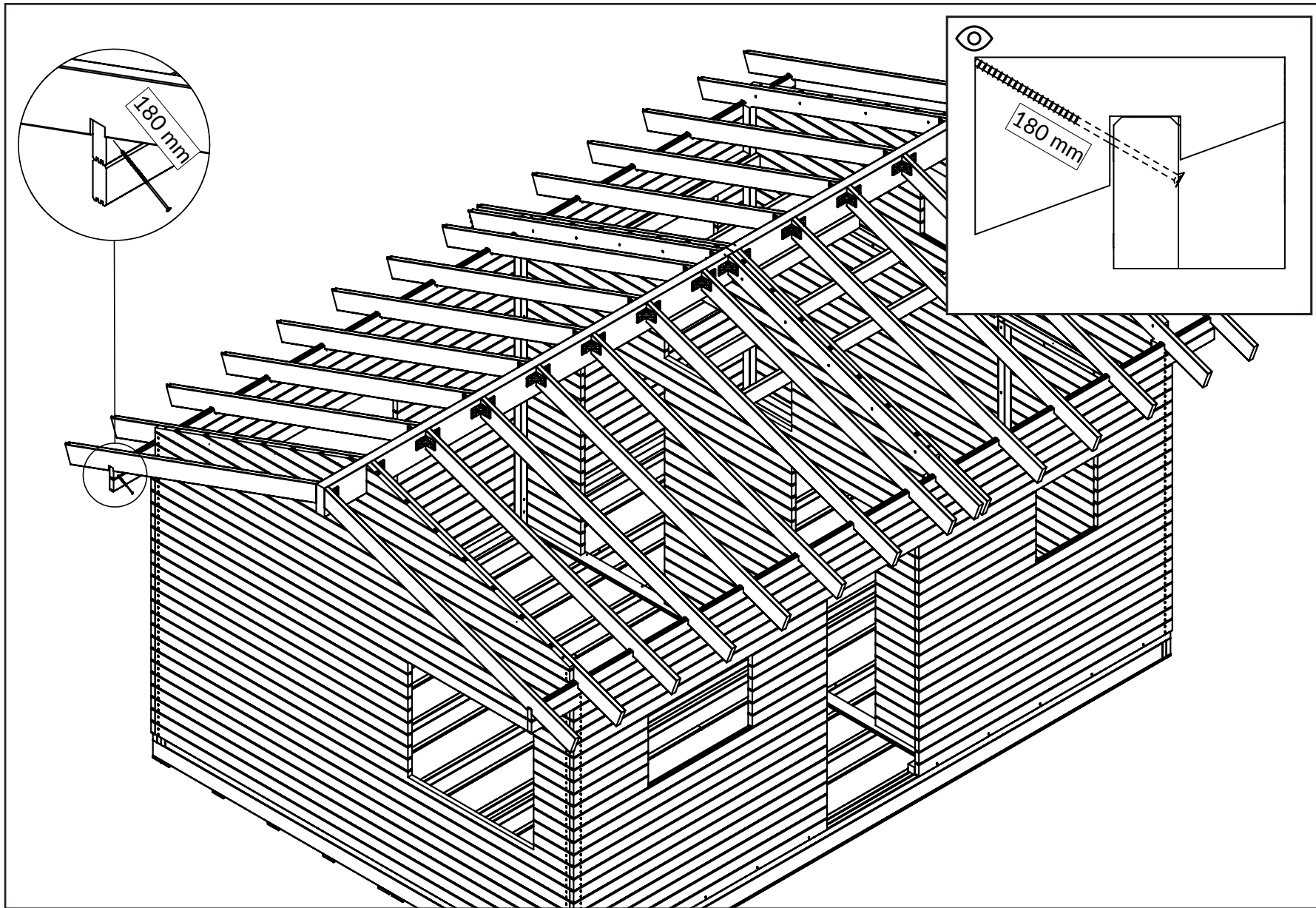

A|1→2→3→4→5→ B|1→2→3→4→5→6→7→8→9→10→11→12→13→14→15→16→17→18→19→20→
 C|1→2→3→4→5→6→7→8→9→ D|1→2→3→4→5→6→7→8→ E|1→2→3→4→5→6→7→
 F|1→2→3→4→5→6→7→ G|1→2→3→ H|1→2→3→ I|1→2→3→4→5→ J|1→2→3→4→

D6

A|1→2→3→4→5→ B|1→2→3→4→5→6→7→8→9→10→11→12→13→14→15→16→17→18→19→20→
C|1→2→3→4→5→6→7→8→9→ D|1→2→3→4→5→6→7→8→ E|1→2→3→4→5→6→7→
F|1→2→3→4→5→6→7→ G|1→2→3→ H|1→2→3→ I|1→2→3→4→5→ J|1→2→3→4→

D7

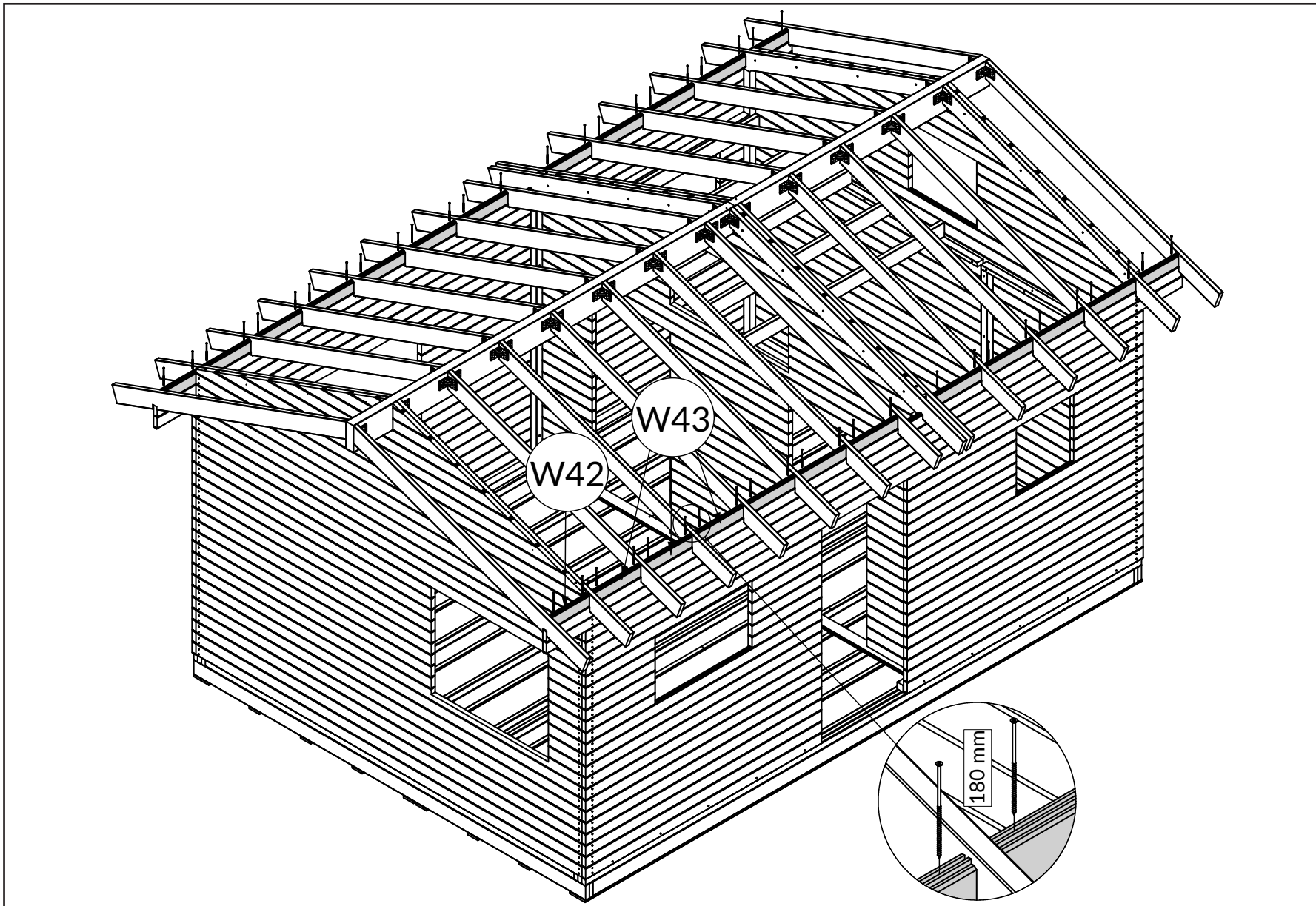

W42 x4

W43 x20

180mm

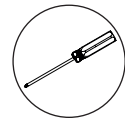
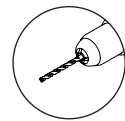
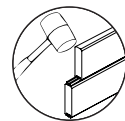

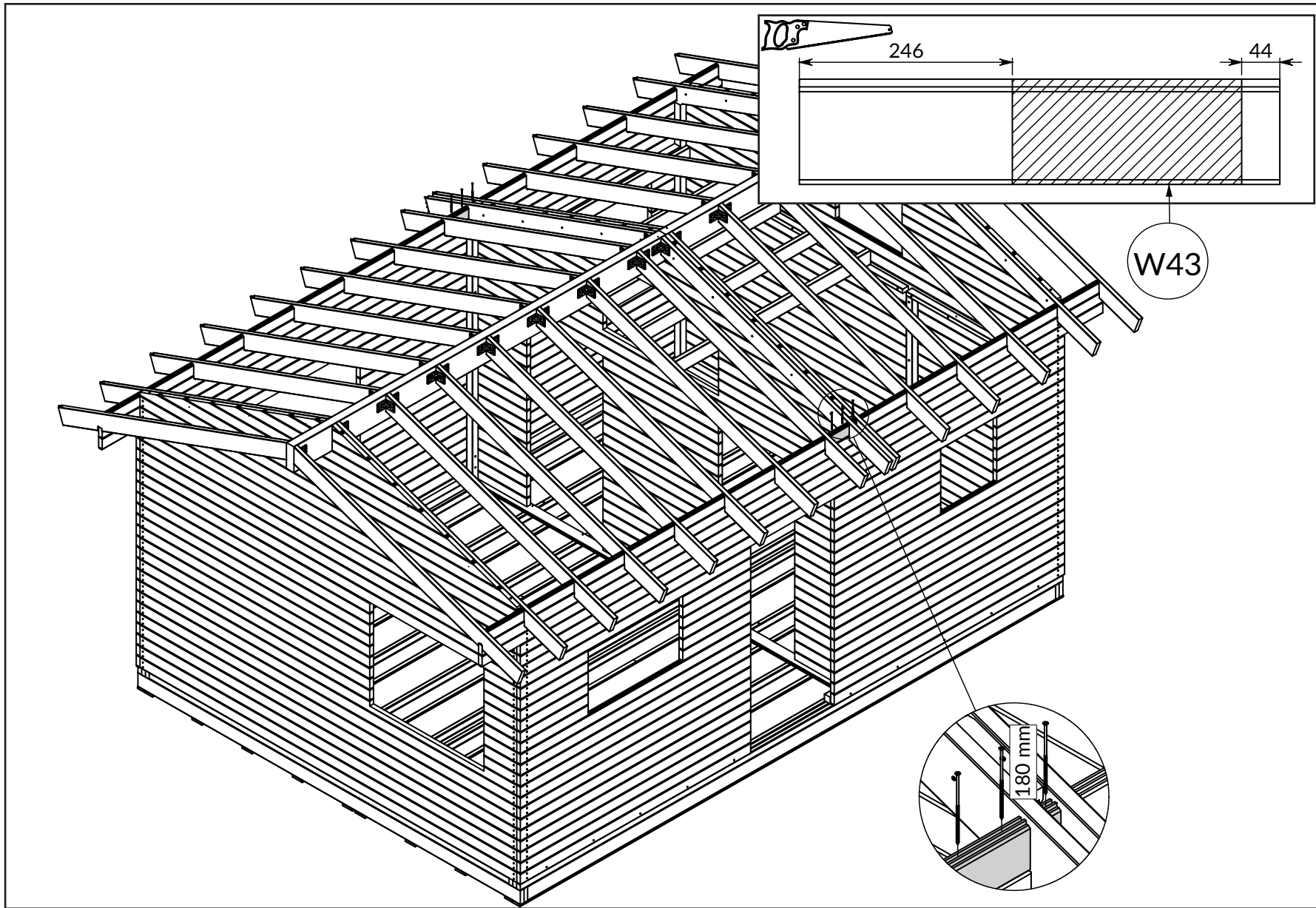

W43 x2

W43

180mm

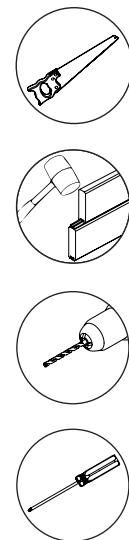

A|1→2→3→4→5→ B|1→2→3→4→5→6→7→8→9→10→11→12→13→14→15→16→17→18→19→20→
 C|1→2→3→4→5→6→7→8→9→ D|1→2→3→4→5→6→7→8→ E|1→2→3→4→5→6→7→
 F|1→2→3→4→5→6→7→ G|1→2→3→ H|1→2→3→ I|1→2→3→4→5→ J|1→2→3→4→

D8

E

E

- W44
x66   (90x18.5) x 5093mm (RB-1)
- W45
x66   (90x18.5) x 2319mm (RB-2)
- W46
x4   (90x18) x 3517mm (TB1)
- W47
x4   (90x18) x 3895mm (TB2)
- W48
x8   (120x18) x 3050mm (GL1)
- W49
x4   (140x18) x 3050mm (GL2)
- W50
x4   (58x18) x 3050mm (RFF)

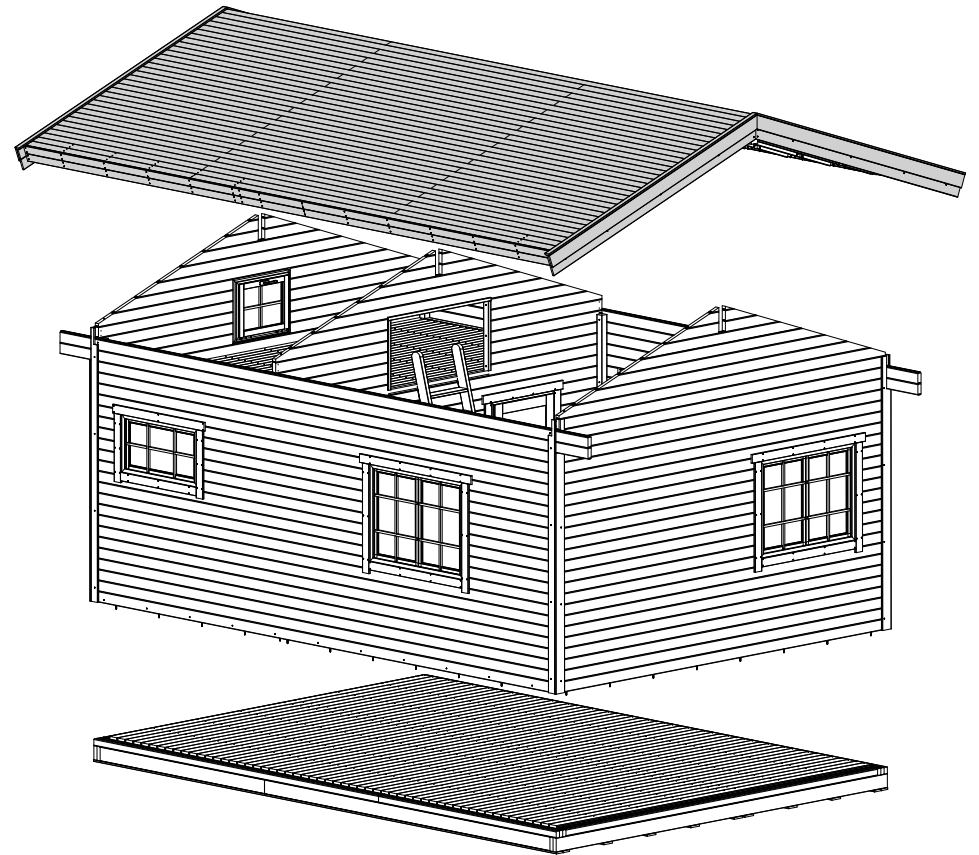
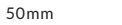
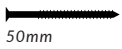

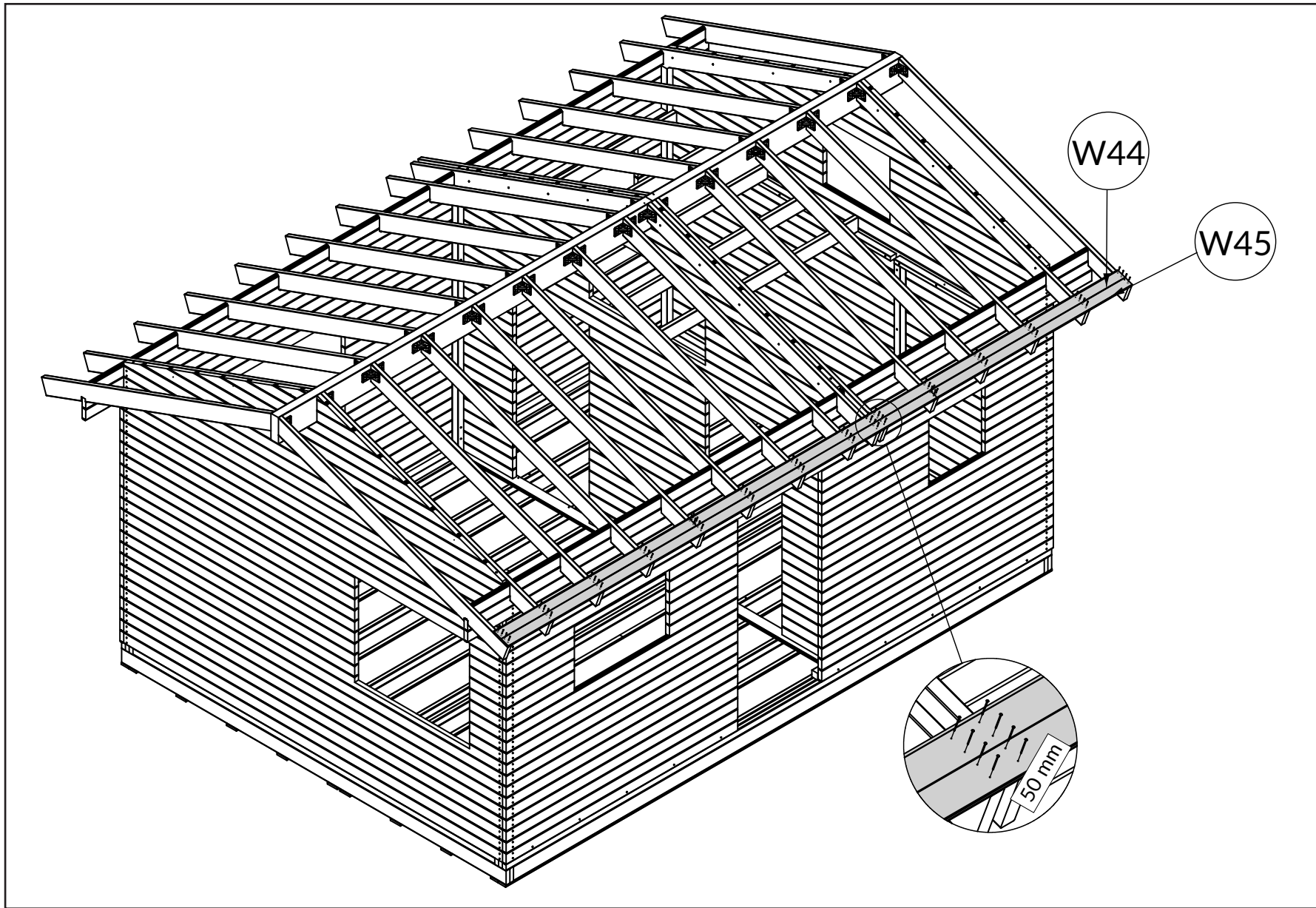

W44 x2

W45 x2

W44

W45

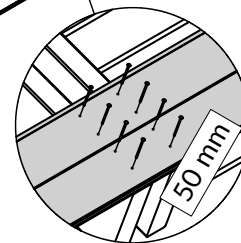

50mm

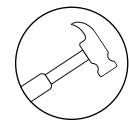

A|1→2→3→4→5→ B|1→2→3→4→5→6→7→8→9→10→11→12→13→14→15→16→17→18→19→20→
 C|1→2→3→4→5→6→7→8→9→ D|1→2→3→4→5→6→7→8→ E|1→2→3→4→5→6→7→
 F|1→2→3→4→5→6→7→ G|1→2→3→ H|1→2→3→ I|1→2→3→4→5→ J|1→2→3→4→

E1

A|1→2→3→4→5→ B|1→2→3→4→5→6→7→8→9→10→11→12→13→14→15→16→17→18→19→20→
C|1→2→3→4→5→6→7→8→9→ D|1→2→3→4→5→6→7→8→ E|1→2→3→4→5→6→7→
F|1→2→3→4→5→6→7→ G|1→2→3→ H|1→2→3→ I|1→2→3→4→5→ J|1→2→3→4→

E2

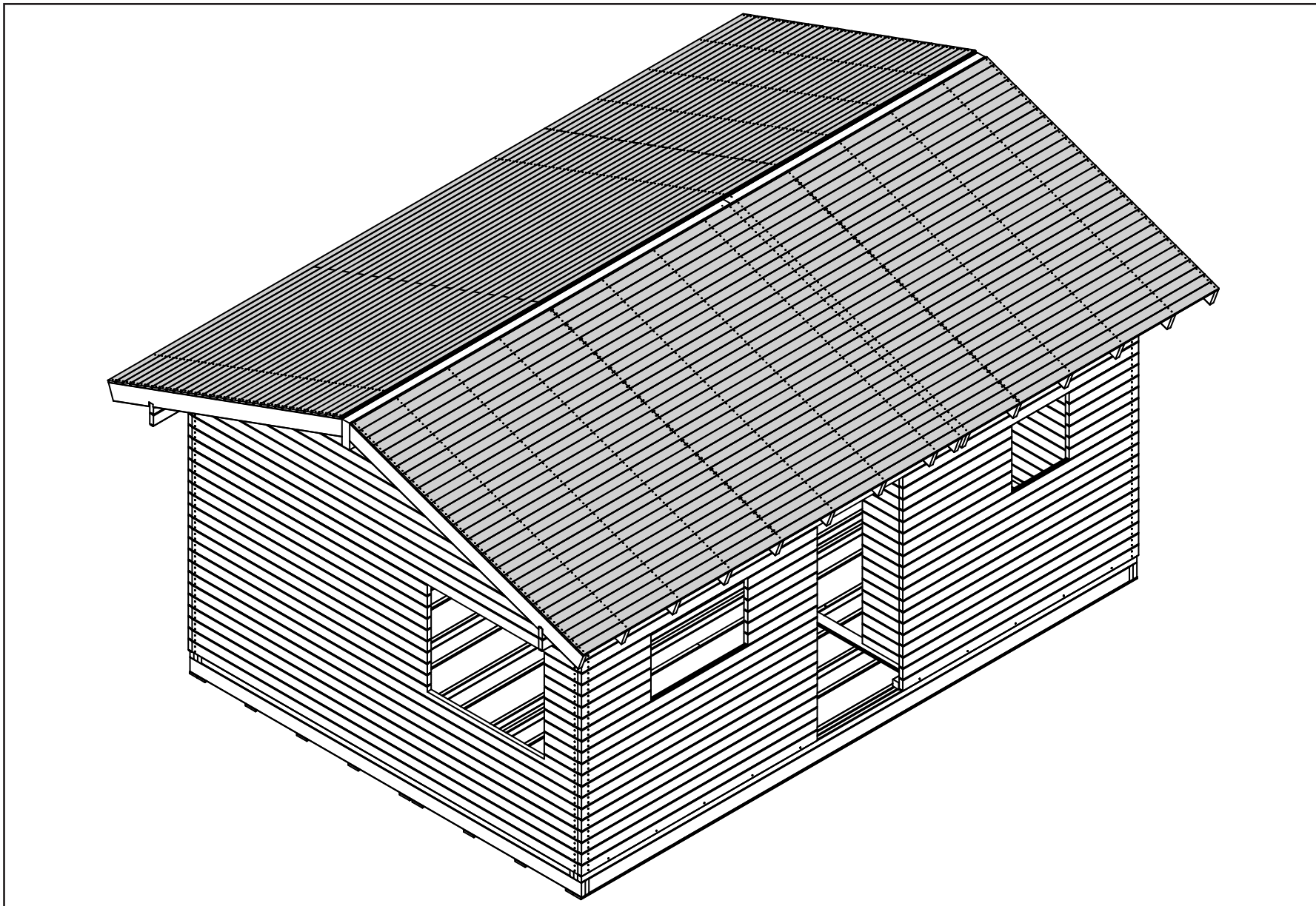

W44 x63

W45 x63

50mm



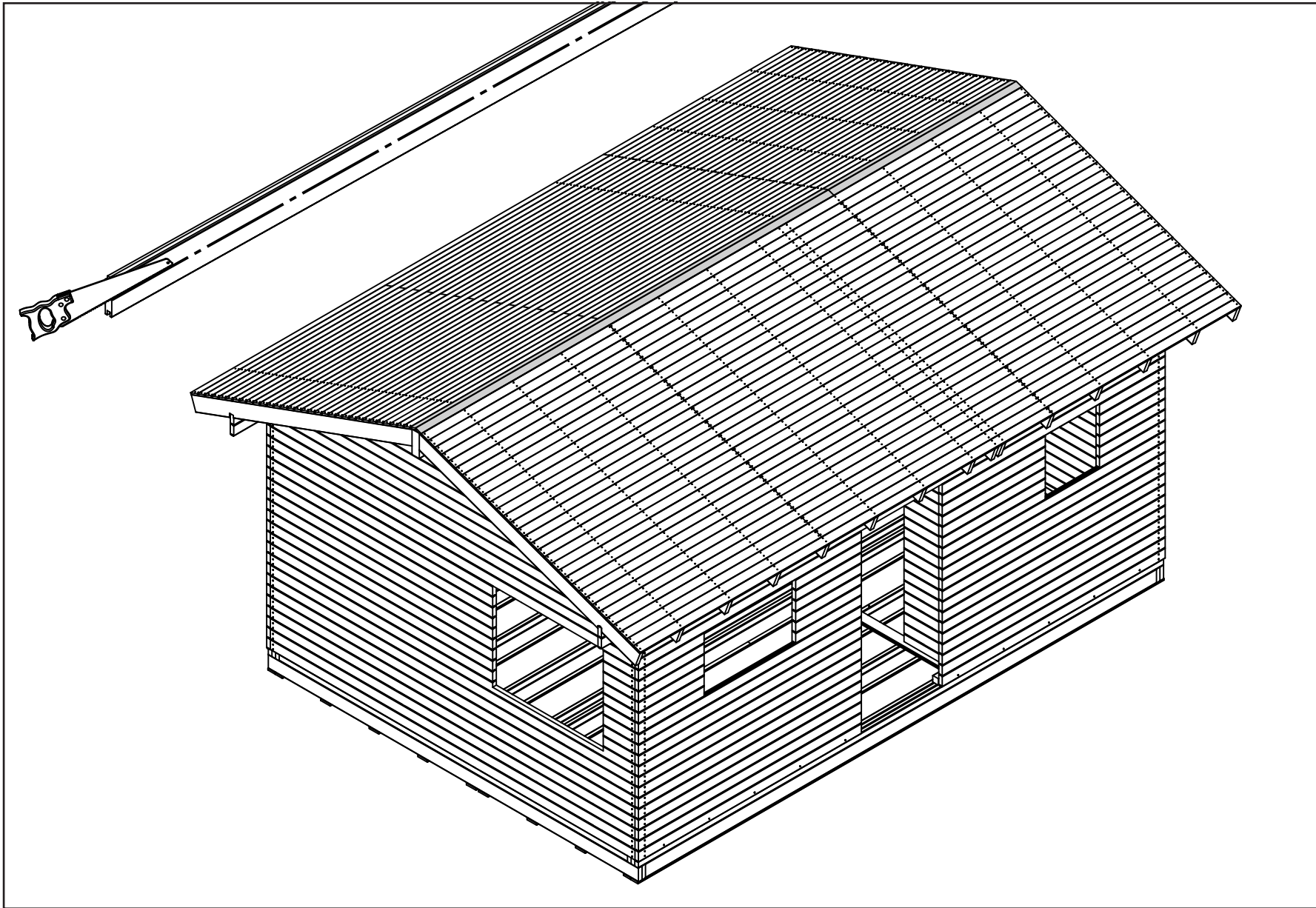

W44 x1

W45 x1

50mm

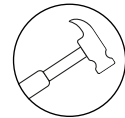

A|1→2→3→4→5→ B|1→2→3→4→5→6→7→8→9→10→11→12→13→14→15→16→17→18→19→20→
 C|1→2→3→4→5→6→7→8→9→ D|1→2→3→4→5→6→7→8→ E|1→2→3→4→5→6→7→
 F|1→2→3→4→5→6→7→ G|1→2→3→ H|1→2→3→ I|1→2→3→4→5→ J|1→2→3→4→

E3

A|1→2→3→4→5→ B|1→2→3→4→5→6→7→8→9→10→11→12→13→14→15→16→17→18→19→20→
C|1→2→3→4→5→6→7→8→9→ D|1→2→3→4→5→6→7→8→ E|1→2→3→4→5→6→7→
F|1→2→3→4→5→6→7→ G|1→2→3→ H|1→2→3→ I|1→2→3→4→5→ J|1→2→3→4→

E4

W46 x4

W47 x4

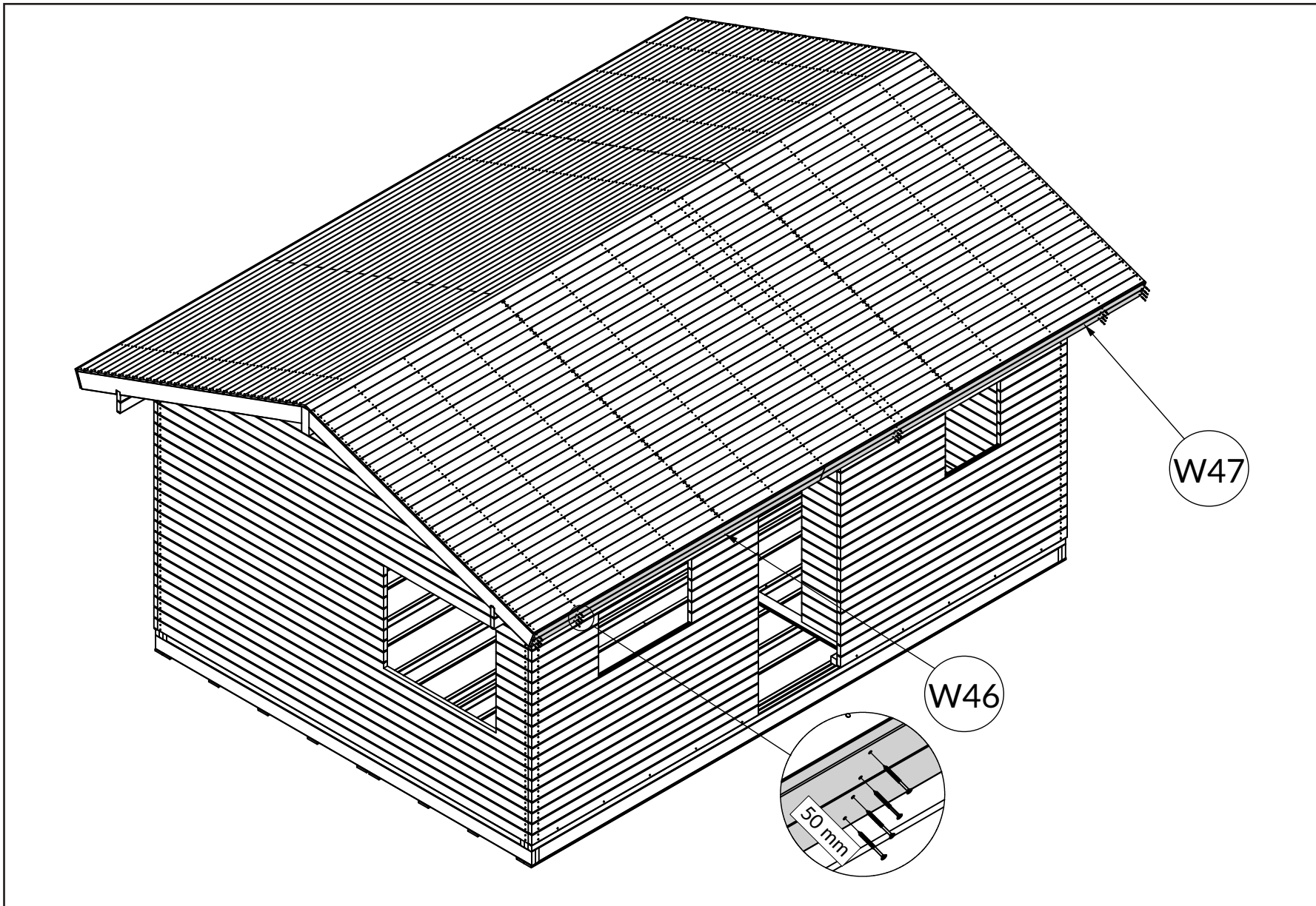

W47

W46

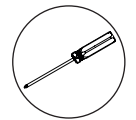
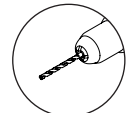
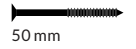
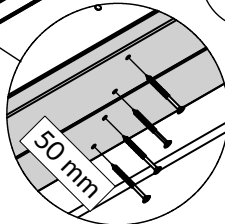

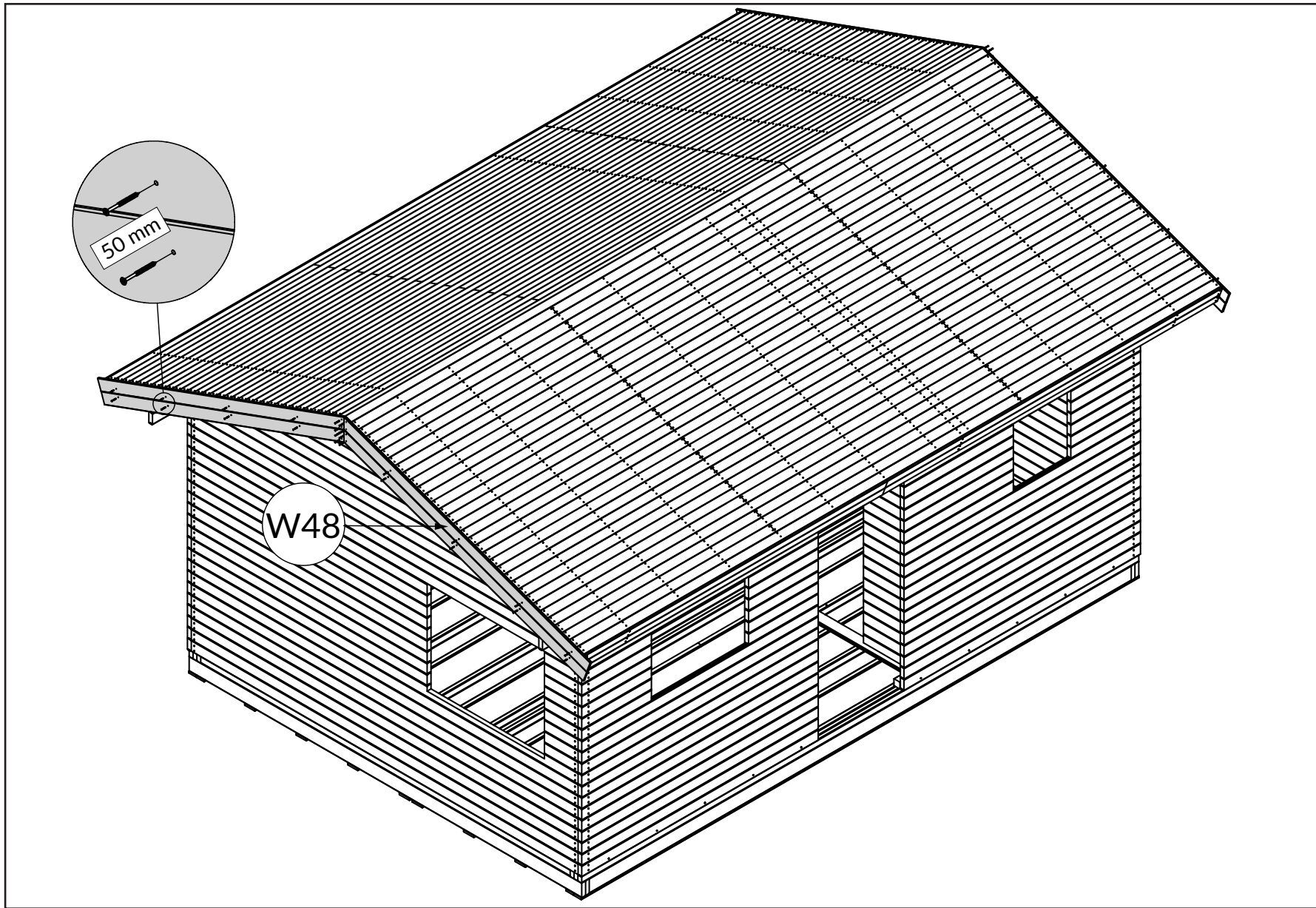

W48 x8

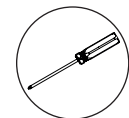
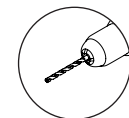
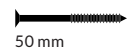

A|1→2→3→4→5→ B|1→2→3→4→5→6→7→8→9→10→11→12→13→14→15→16→17→18→19→20→
 C|1→2→3→4→5→6→7→8→9→ D|1→2→3→4→5→6→7→8→ E|1→2→3→4→5→6→7→
 F|1→2→3→4→5→6→7→ G|1→2→3→ H|1→2→3→ I|1→2→3→4→5→ J|1→2→3→4→

E5

A|1→2→3→4→5→ B|1→2→3→4→5→6→7→8→9→10→11→12→13→14→15→16→17→18→19→20→
C|1→2→3→4→5→6→7→8→9→ D|1→2→3→4→5→6→7→8→ E|1→2→3→4→5→6→7→
F|1→2→3→4→5→6→7→ G|1→2→3→ H|1→2→3→ I|1→2→3→4→5→ J|1→2→3→4→

E6

W49 x4

W49

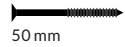
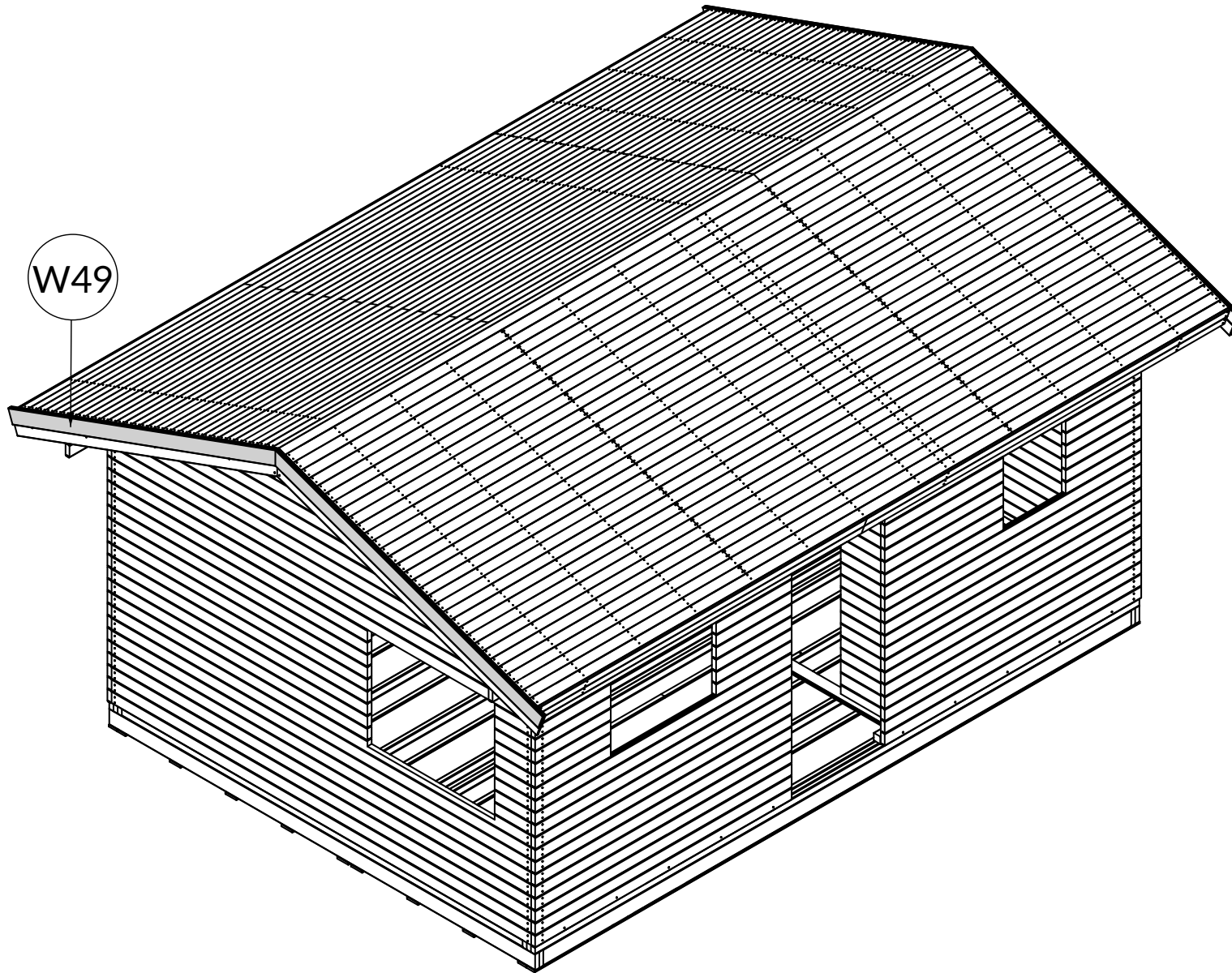

50 mm

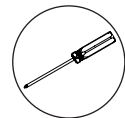
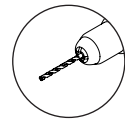

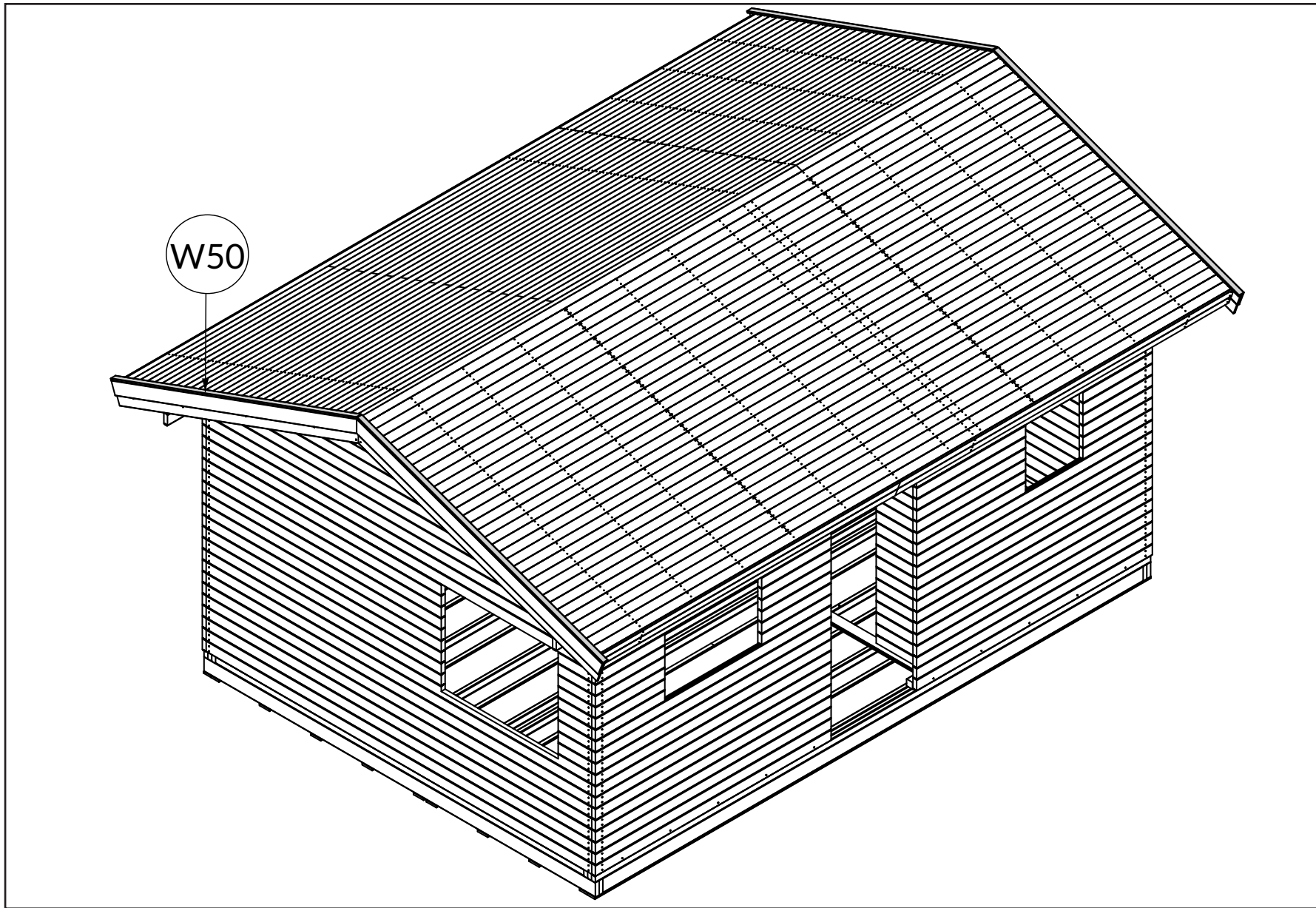

W50 x4

W50

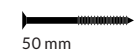

50 mm

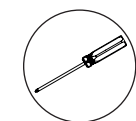
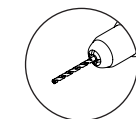

A|1→2→3→4→5→ B|1→2→3→4→5→6→7→8→9→10→11→12→13→14→15→16→17→18→19→20→
 C|1→2→3→4→5→6→7→8→9→ D|1→2→3→4→5→6→7→8→ E|1→2→3→4→5→6→7→
 F|1→2→3→4→5→6→7→ G|1→2→3→ H|1→2→3→ I|1→2→3→4→5→ J|1→2→3→4→

E7

F

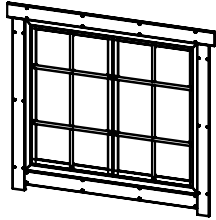

x2

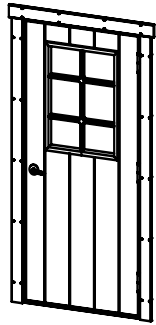

x1

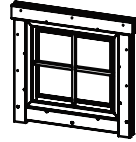

x1

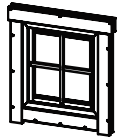

x1

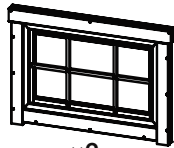

x2

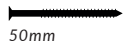

50mm

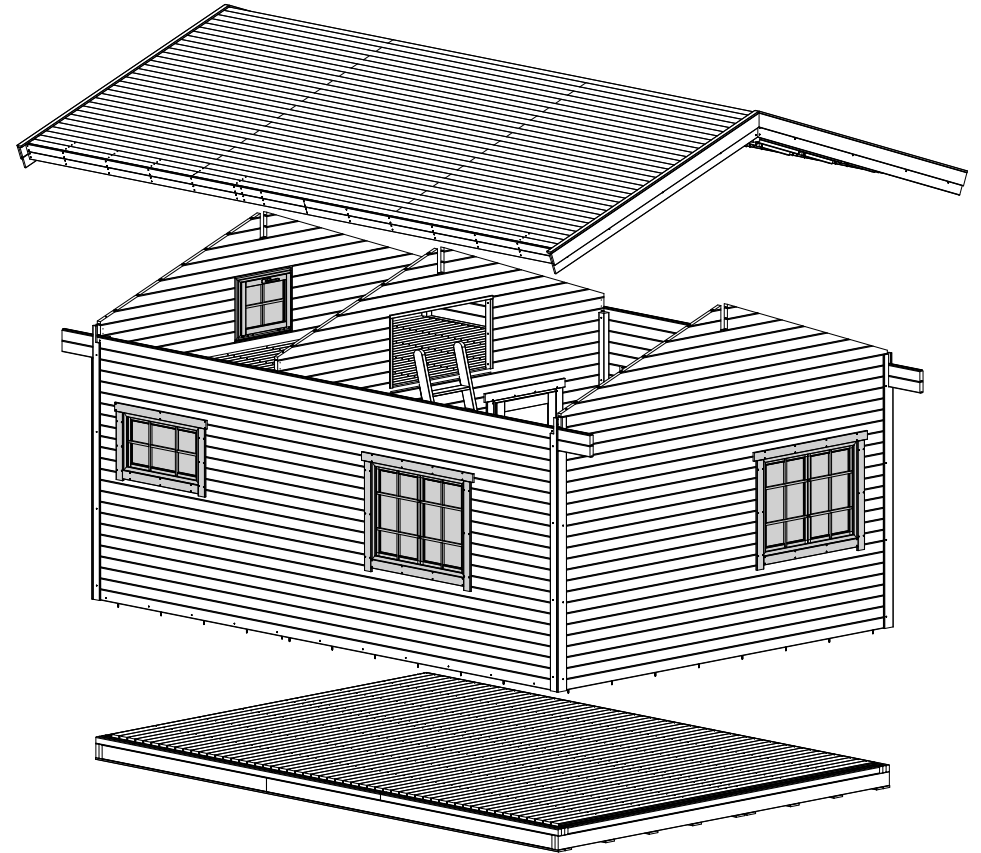

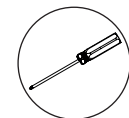
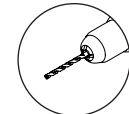
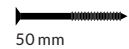
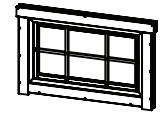
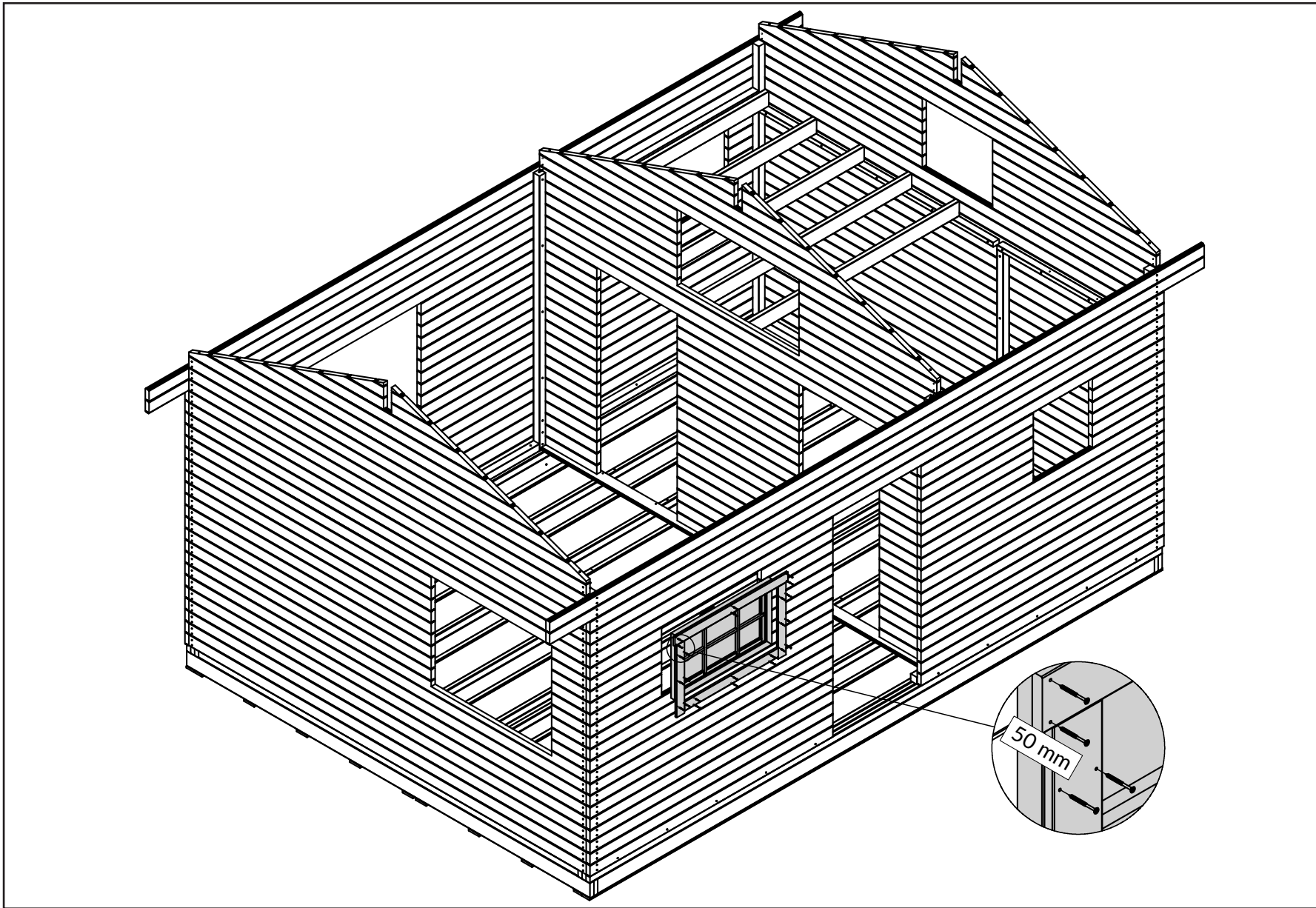

A|1→2→3→4→5→ **B**|1→2→3→4→5→6→7→8→9→10→11→12→13→14→15→16→17→18→19→20→
C|1→2→3→4→5→6→7→8→9→ **D**|1→2→3→4→5→6→7→8→ **E**|1→2→3→4→5→6→7→
F|1→2→3→4→5→6→7→ **G**|1→2→3→ **H**|1→2→3→ **I**|1→2→3→4→5→ **J**|1→2→3→4→

F1

A|1→2→3→4→5→ B|1→2→3→4→5→6→7→8→9→10→11→12→13→14→15→16→17→18→19→20→
C|1→2→3→4→5→6→7→8→9→ D|1→2→3→4→5→6→7→8→ E|1→2→3→4→5→6→7→
F|1→2→3→4→5→6→7→ G|1→2→3→ H|1→2→3→ I|1→2→3→4→5→ J|1→2→3→4→

F2

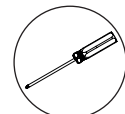
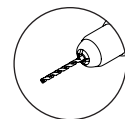
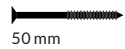
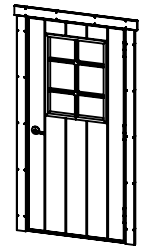
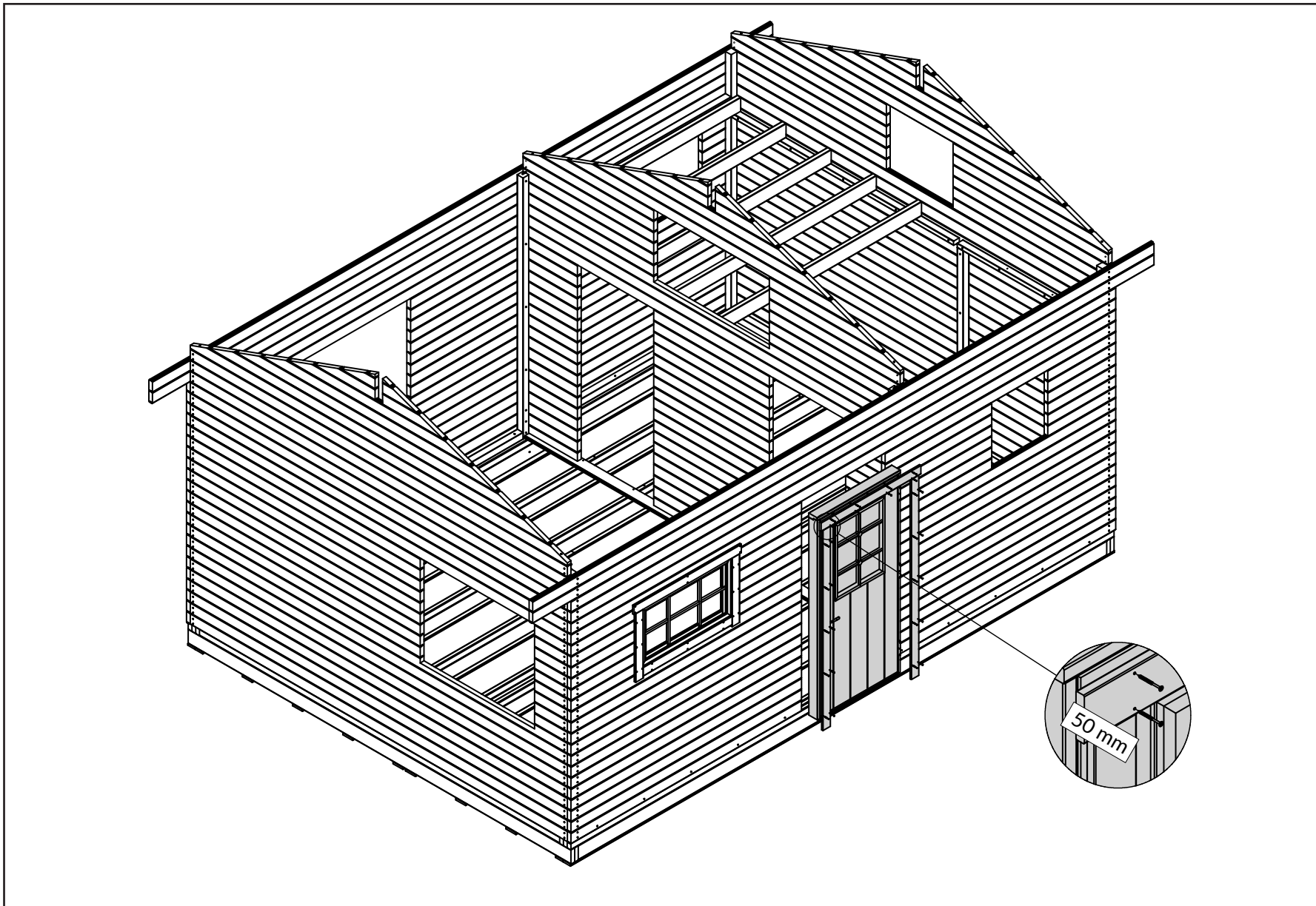

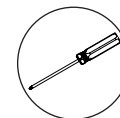
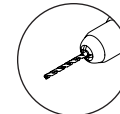
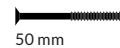
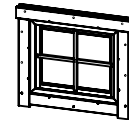
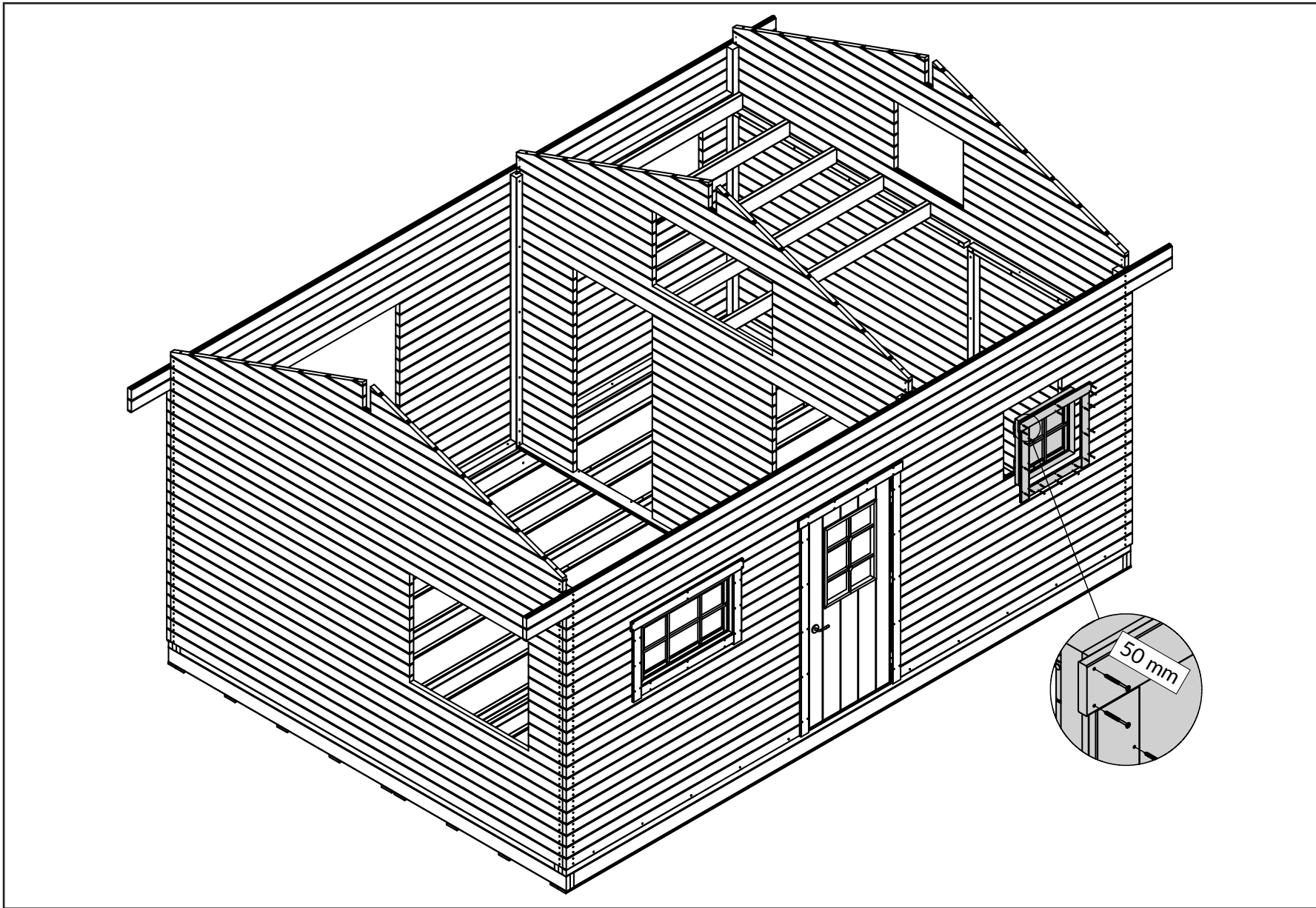

A | 1 → 2 → 3 → 4 → 5 →
 B | 1 → 2 → 3 → 4 → 5 → 6 → 7 → 8 → 9 → 10 → 11 → 12 → 13 → 14 → 15 → 16 → 17 → 18 → 19 → 20 →
C | 1 → 2 → 3 → 4 → 5 → 6 → 7 → 8 → 9 →
 D | 1 → 2 → 3 → 4 → 5 → 6 → 7 → 8 →
 E | 1 → 2 → 3 → 4 → 5 → 6 → 7 →
F | 1 → 2 → 3 → 4 → 5 → 6 → 7 →
 G | 1 → 2 → 3 →
 H | 1 → 2 → 3 →
 I | 1 → 2 → 3 → 4 → 5 →
 J | 1 → 2 → 3 → 4 →

F3

A|1→2→3→4→5→ B|1→2→3→4→5→6→7→8→9→10→11→12→13→14→15→16→17→18→19→20→
C|1→2→3→4→5→6→7→8→9→ D|1→2→3→4→5→6→7→8→ E|1→2→3→4→5→6→7→
F|1→2→3→4→5→6→7→ G|1→2→3→ H|1→2→3→ I|1→2→3→4→5→ J|1→2→3→4→

F4

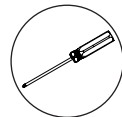
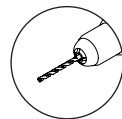
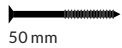
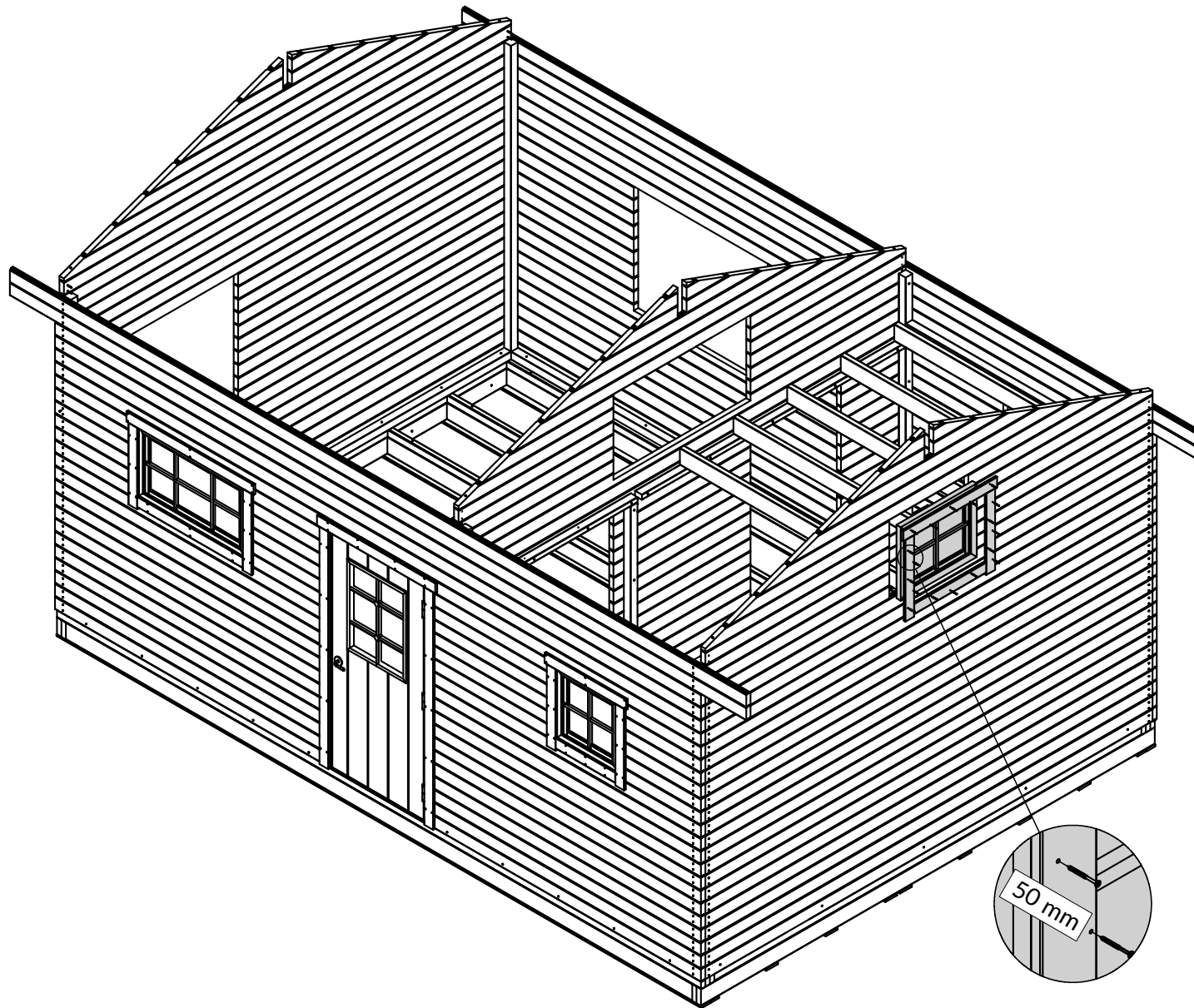

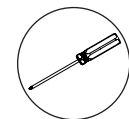
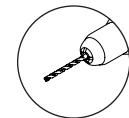
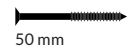
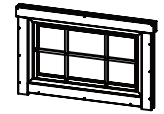
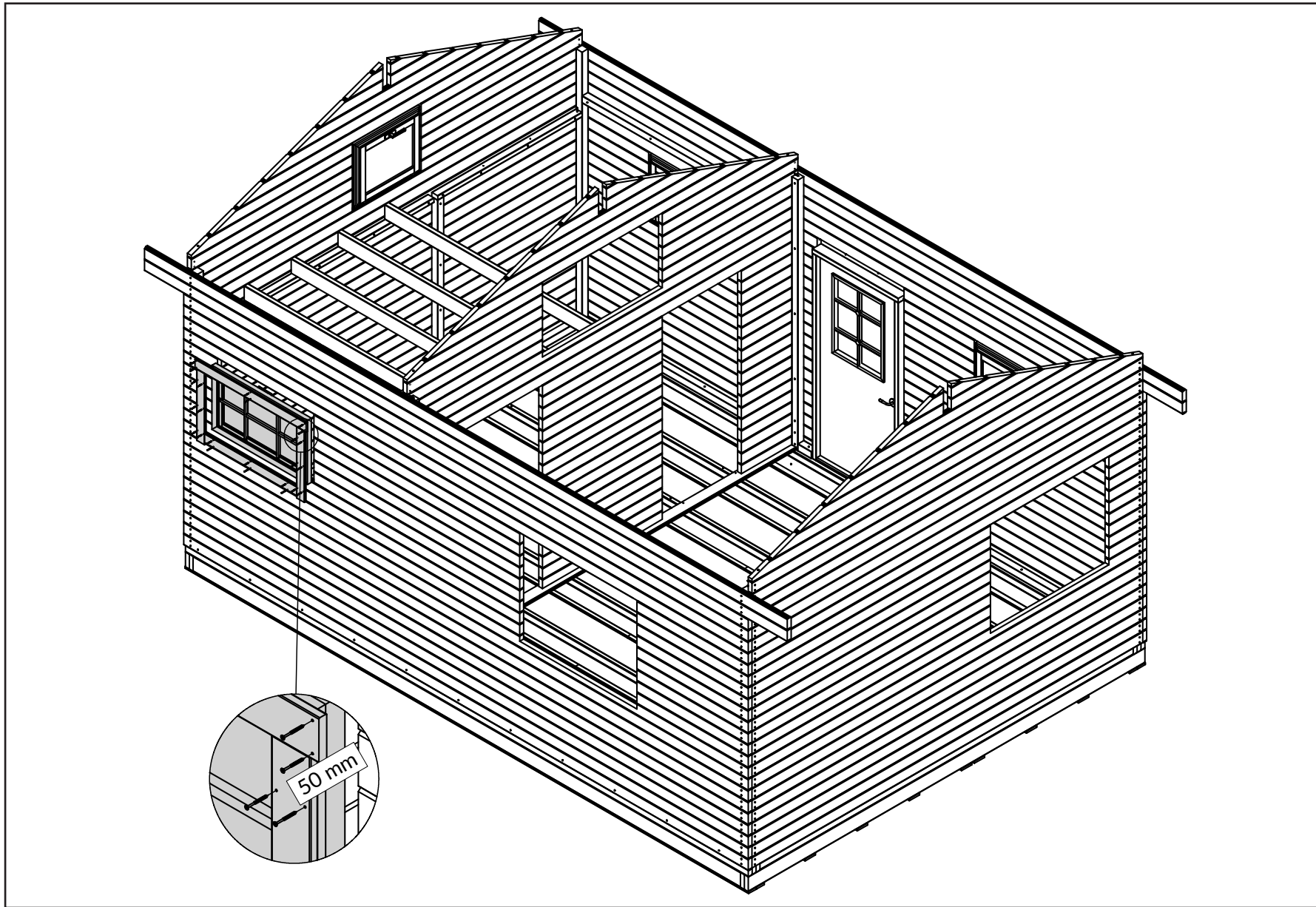

A|1→2→3→4→5→ **B**|1→2→3→4→5→6→7→8→9→10→11→12→13→14→15→16→17→18→19→20→
C|1→2→3→4→5→6→7→8→9→ **D**|1→2→3→4→5→6→7→8→ **E**|1→2→3→4→5→6→7→
F|1→2→3→4→5→6→7→ **G**|1→2→3→ **H**|1→2→3→ **I**|1→2→3→4→5→ **J**|1→2→3→4→

F5

A|1→2→3→4→5→ B|1→2→3→4→5→6→7→8→9→10→11→12→13→14→15→16→17→18→19→20→
C|1→2→3→4→5→6→7→8→9→ D|1→2→3→4→5→6→7→8→ E|1→2→3→4→5→6→7→
F|1→2→3→4→5→6→7→ G|1→2→3→ H|1→2→3→ I|1→2→3→4→5→ J|1→2→3→4→

F6

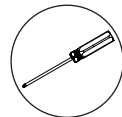
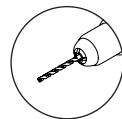
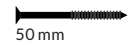
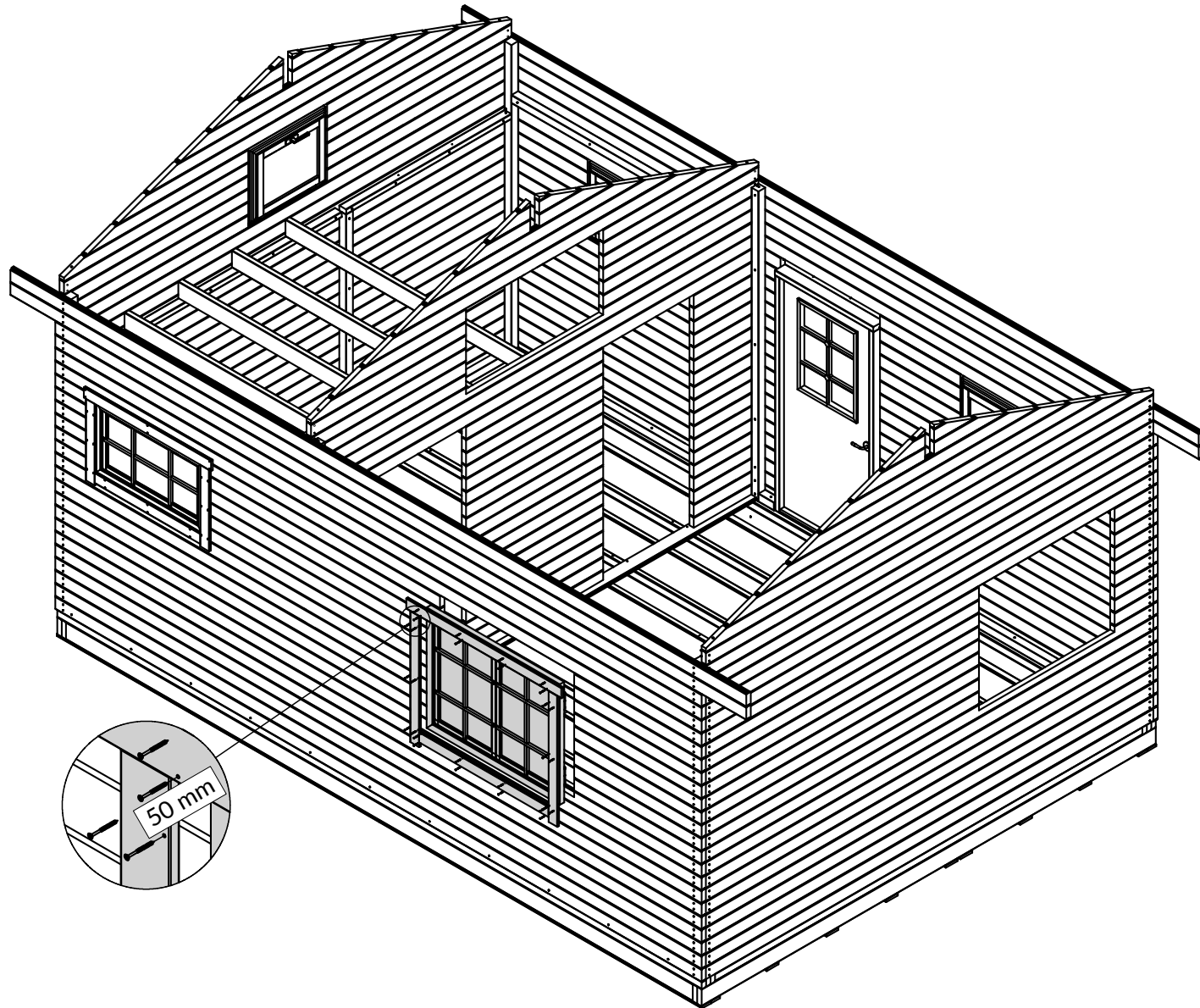
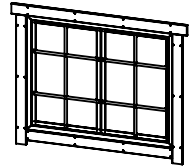

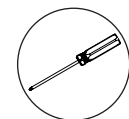
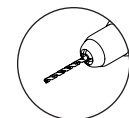
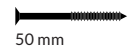
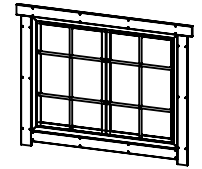
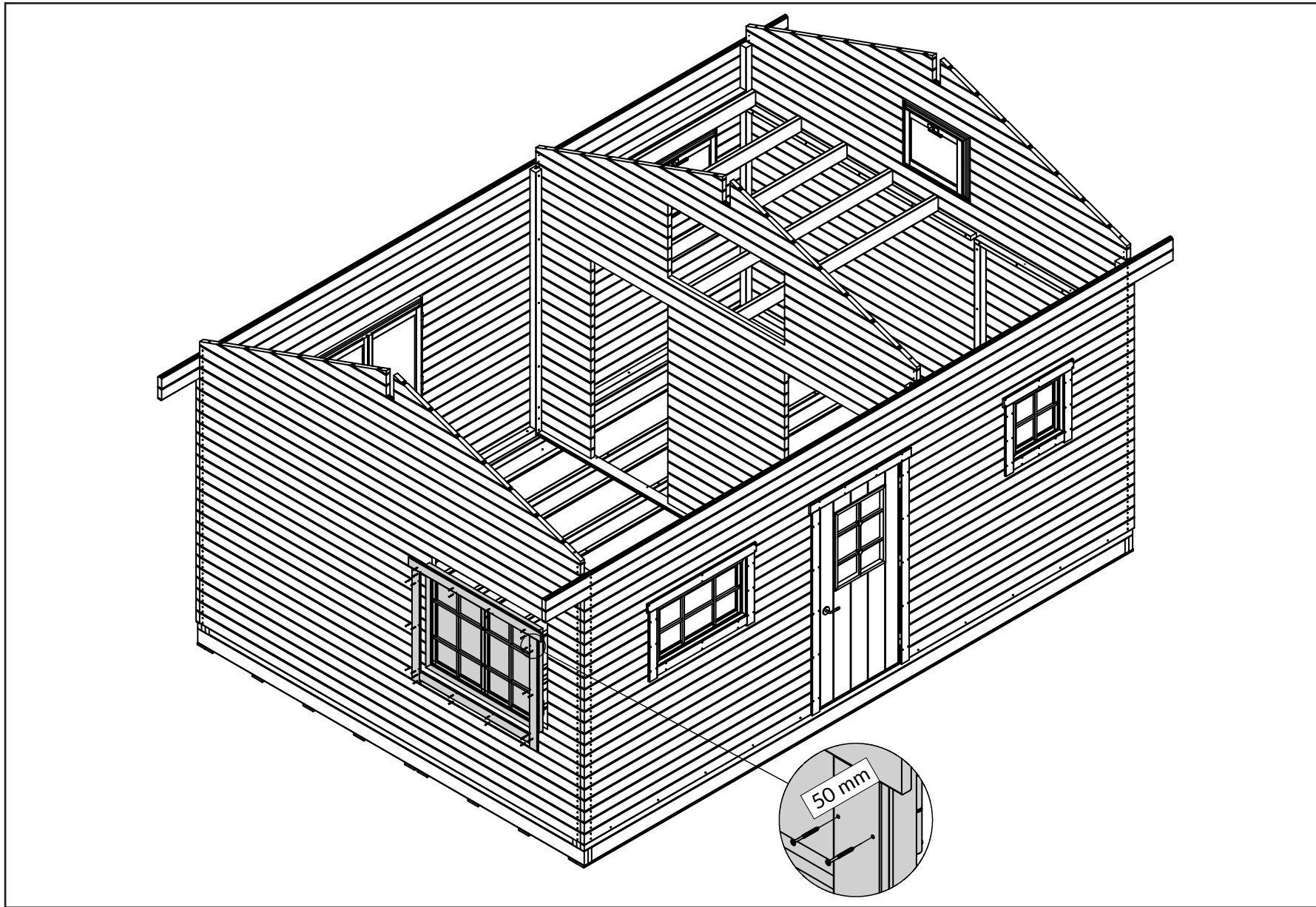

A | 1 → 2 → 3 → 4 → 5 →
 B | 1 → 2 → 3 → 4 → 5 → 6 → 7 → 8 → 9 → 10 → 11 → 12 → 13 → 14 → 15 → 16 → 17 → 18 → 19 → 20 →
C | 1 → 2 → 3 → 4 → 5 → 6 → 7 → 8 → 9 →
 D | 1 → 2 → 3 → 4 → 5 → 6 → 7 → 8 →
 E | 1 → 2 → 3 → 4 → 5 → 6 → 7 →
F | 1 → 2 → 3 → 4 → 5 → 6 → 7 →
 G | 1 → 2 → 3 →
 H | 1 → 2 → 3 →
 I | 1 → 2 → 3 → 4 → 5 →
 J | 1 → 2 → 3 → 4 →

F7

G

W34
x57



(112x28) x 4360mm (HLL-1)

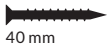

40 mm

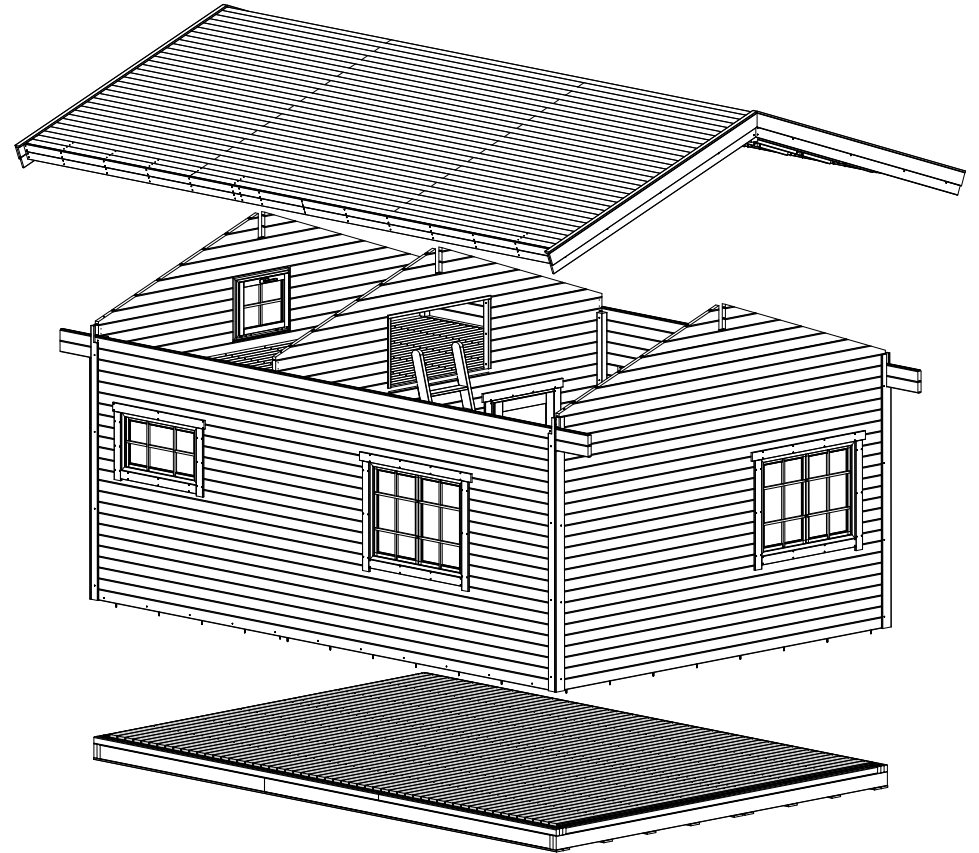

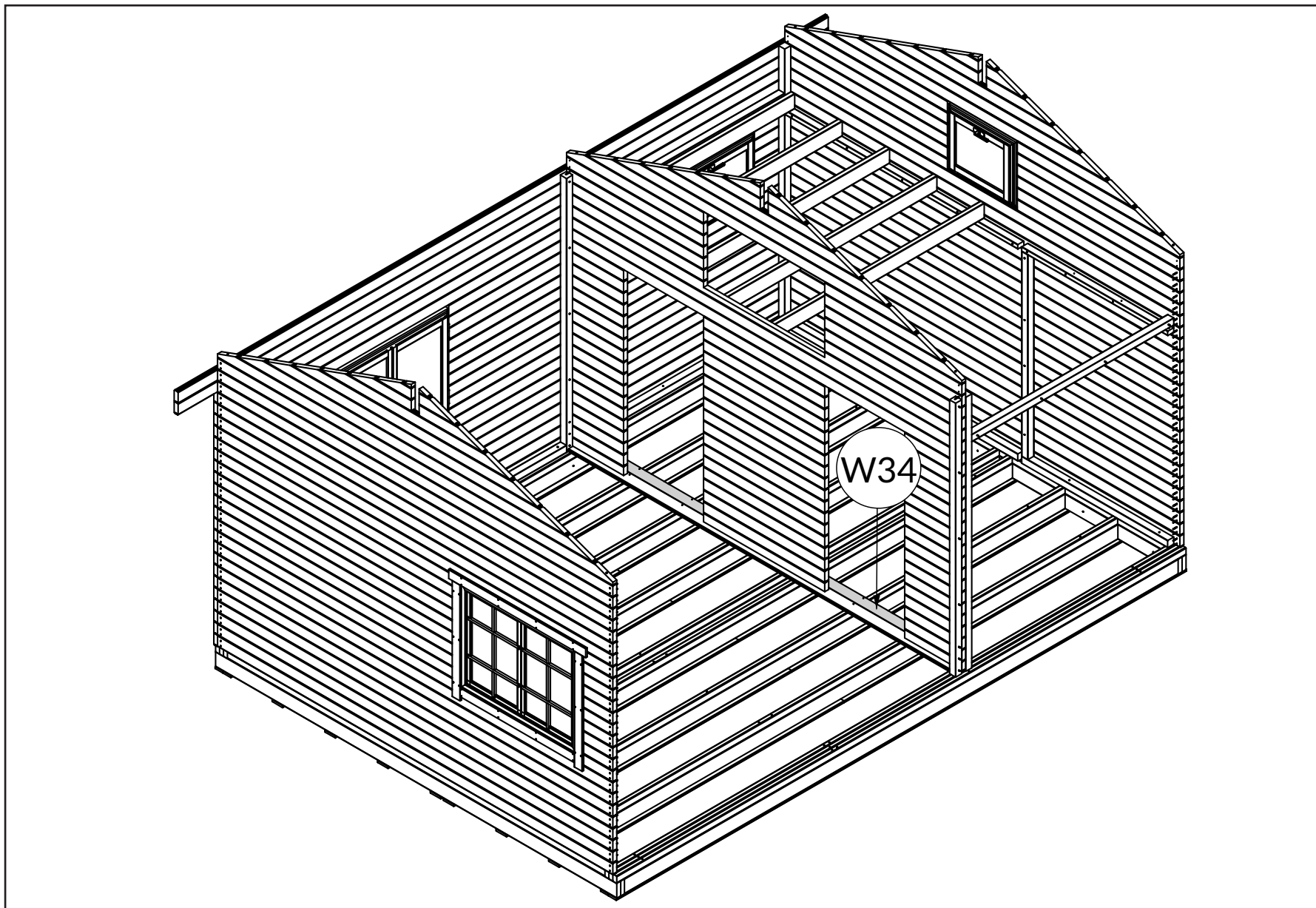

W34 x1

W34

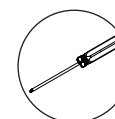
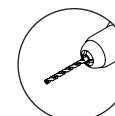
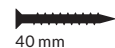

A|1→2→3→4→5→ B|1→2→3→4→5→6→7→8→9→10→11→12→13→14→15→16→17→18→19→20→
 C|1→2→3→4→5→6→7→8→9→ D|1→2→3→4→5→6→7→8→ E|1→2→3→4→5→6→7→
 F|1→2→3→4→5→6→7→ G|1→2→3→ H|1→2→3→ I|1→2→3→4→5→ J|1→2→3→4→

G1

G2

A|1→2→3→4→5→ B|1→2→3→4→5→6→7→8→9→10→11→12→13→14→15→16→17→18→19→20→
C|1→2→3→4→5→6→7→8→9→ D|1→2→3→4→5→6→7→8→ E|1→2→3→4→5→6→7→
F|1→2→3→4→5→6→7→ G|1→2→3→ H|1→2→3→ I|1→2→3→4→5→ J|1→2→3→4→

W34 x19

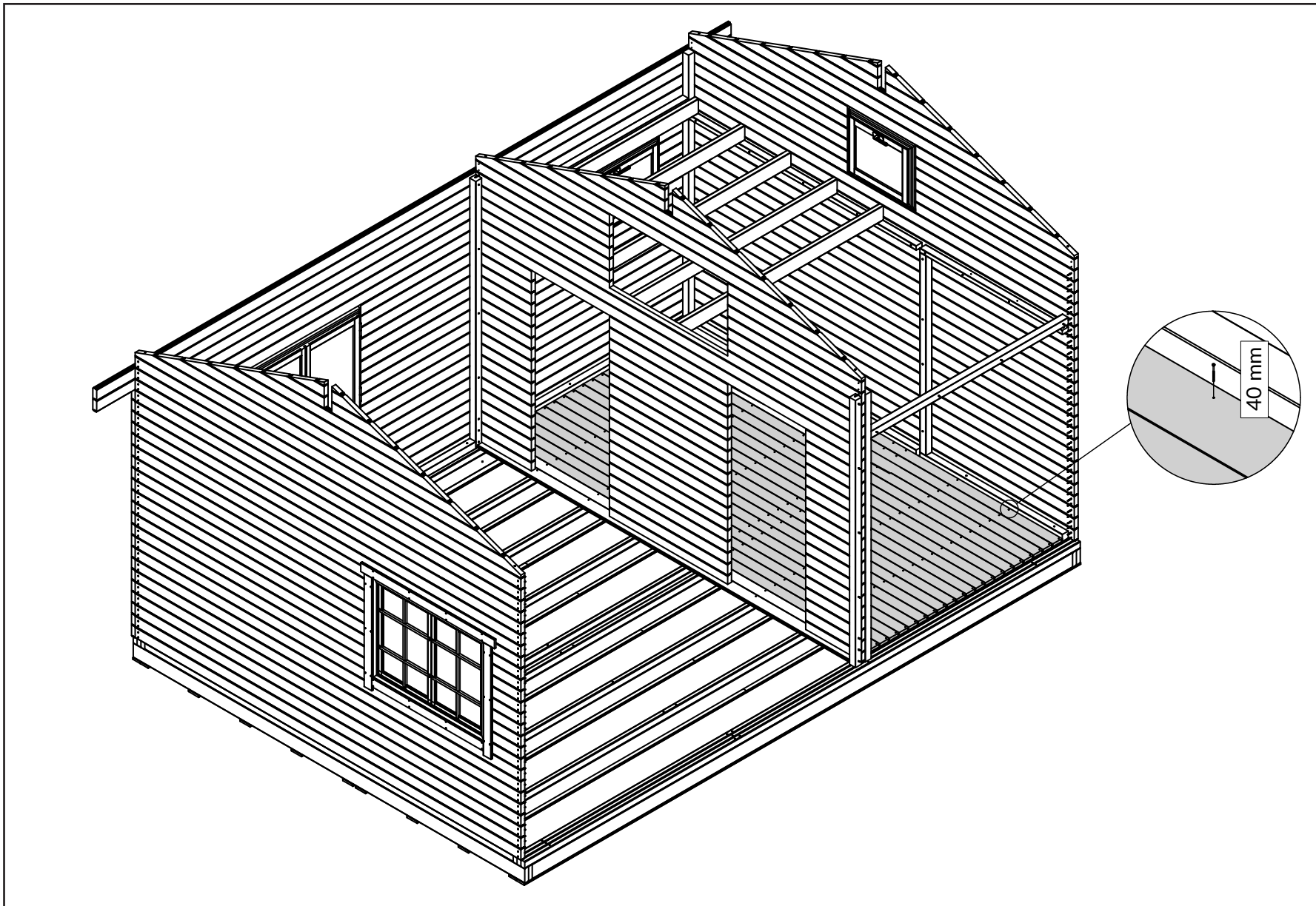

40 mm

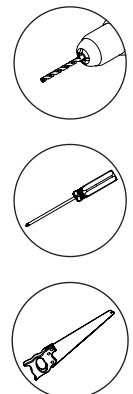

W34 x34

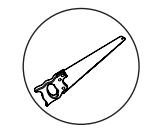
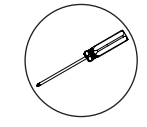
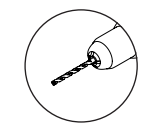
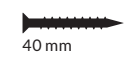
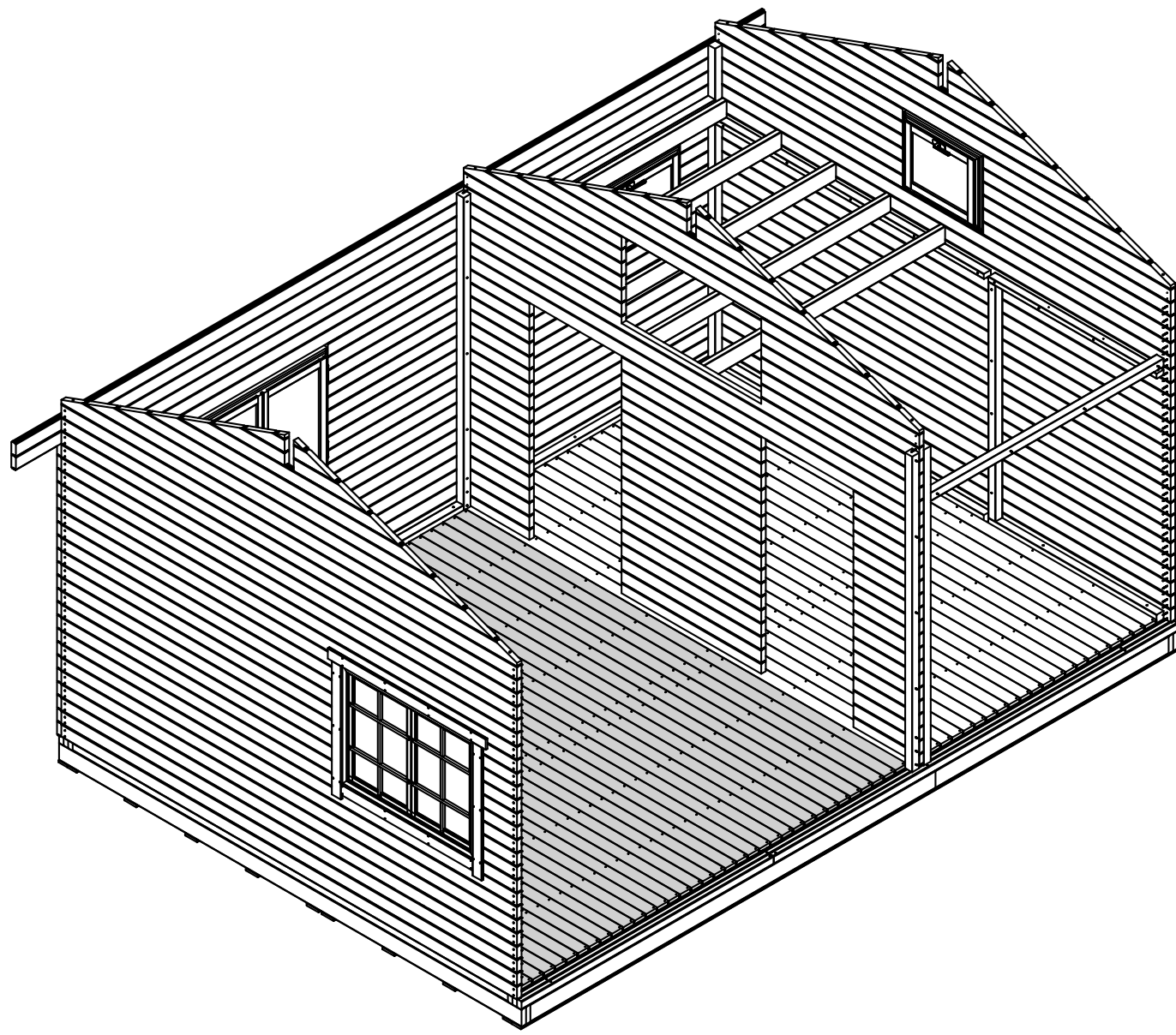



A|1→2→3→4→5→ B|1→2→3→4→5→6→7→8→9→10→11→12→13→14→15→16→17→18→19→20→
C|1→2→3→4→5→6→7→8→9→ D|1→2→3→4→5→6→7→8→ E|1→2→3→4→5→6→7→
F|1→2→3→4→5→6→7→ G|1→2→3→ H|1→2→3→ I|1→2→3→4→5→ J|1→2→3→4→

G3

H

H

W51
x1 
(86x44) x 2440mm (013)

W52
x18 
(114x44) x 2440mm (014)

W53
x1 
(114x44) x 2440mm (015)

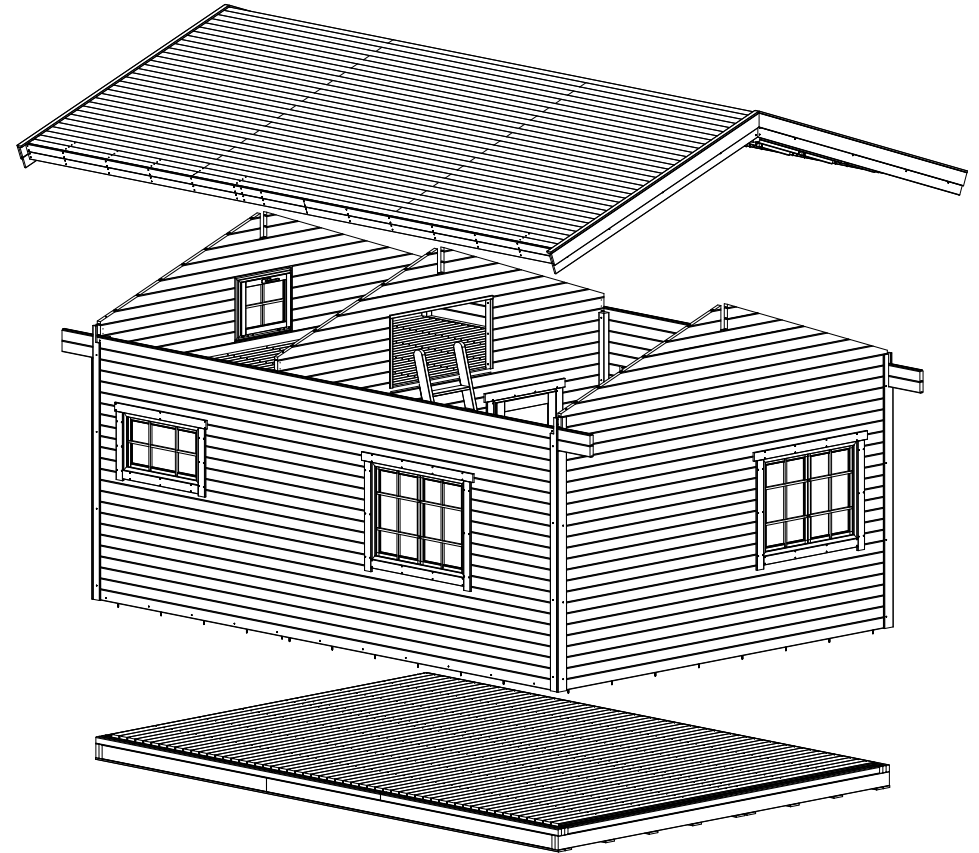
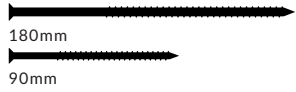



V-1

e	V-1	W51		x1	W51.1
		W52		x19	W52.1
		W53		x1	W53.1
	V-2	W51		x1	W51.2
		W52		x19	W52.2
		W53		x1	W53.2

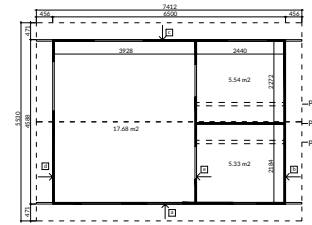

V-1

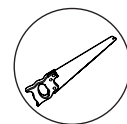

A|1→2→3→4→5→ B|1→2→3→4→5→6→7→8→9→10→11→12→13→14→15→16→17→18→19→20→
 C|1→2→3→4→5→6→7→8→9→ D|1→2→3→4→5→6→7→8→ E|1→2→3→4→5→6→7→
 F|1→2→3→4→5→6→7→ G|1→2→3→ H|1→2→3→ I|1→2→3→4→5→ J|1→2→3→4→

H1

A|1→2→3→4→5→ B|1→2→3→4→5→6→7→8→9→10→11→12→13→14→15→16→17→18→19→20→
C|1→2→3→4→5→6→7→8→9→ D|1→2→3→4→5→6→7→8→ E|1→2→3→4→5→6→7→
F|1→2→3→4→5→6→7→ G|1→2→3→ H|1→2→3→ I|1→2→3→4→5→ J|1→2→3→4→

H2

W51.1 x1

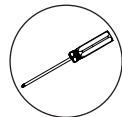
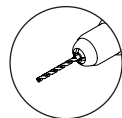
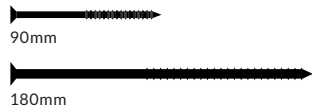
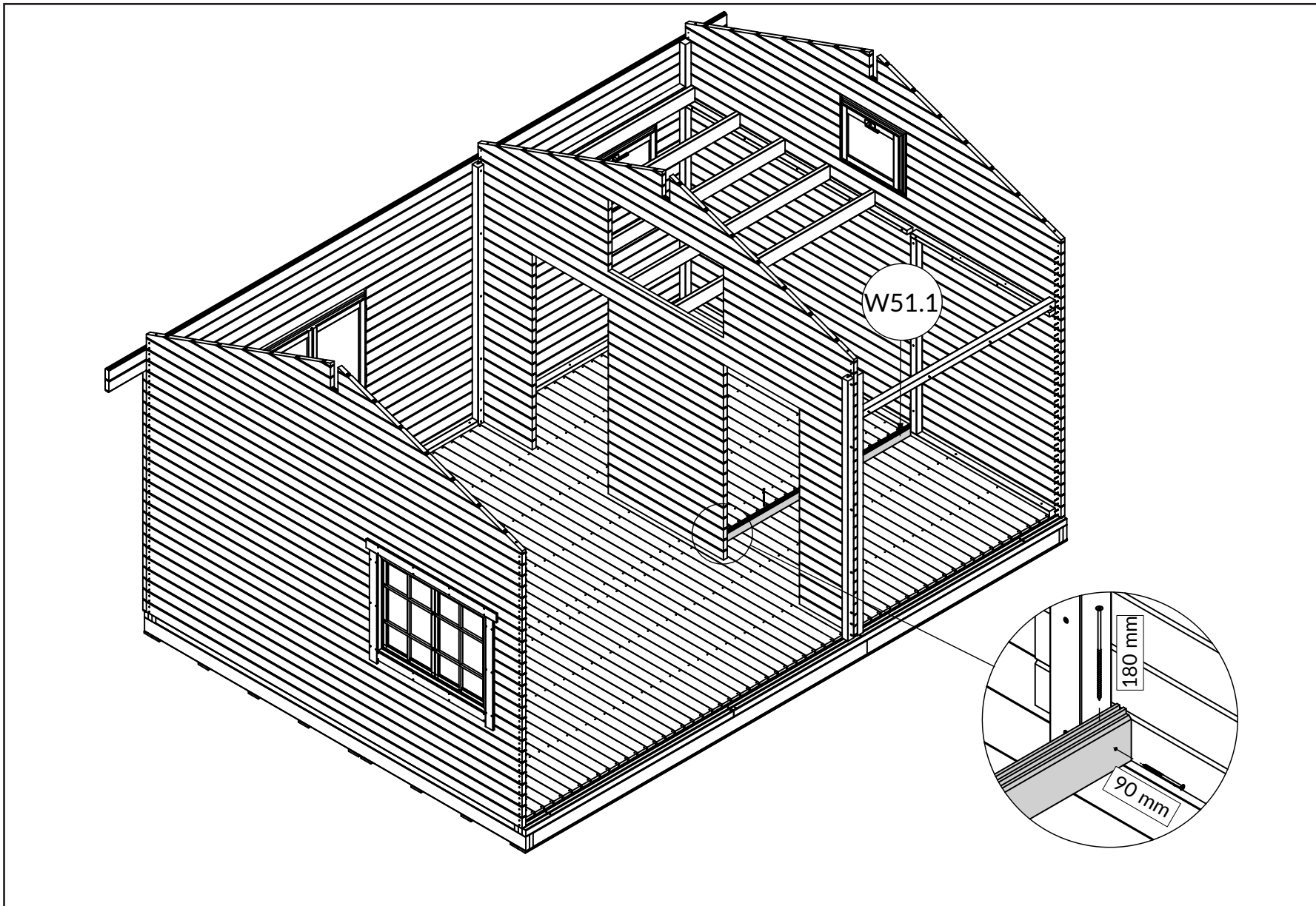

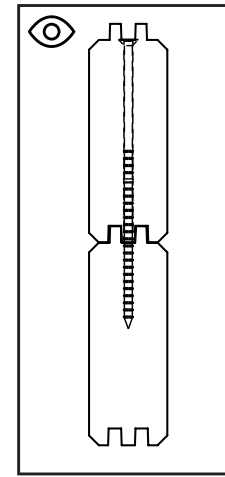
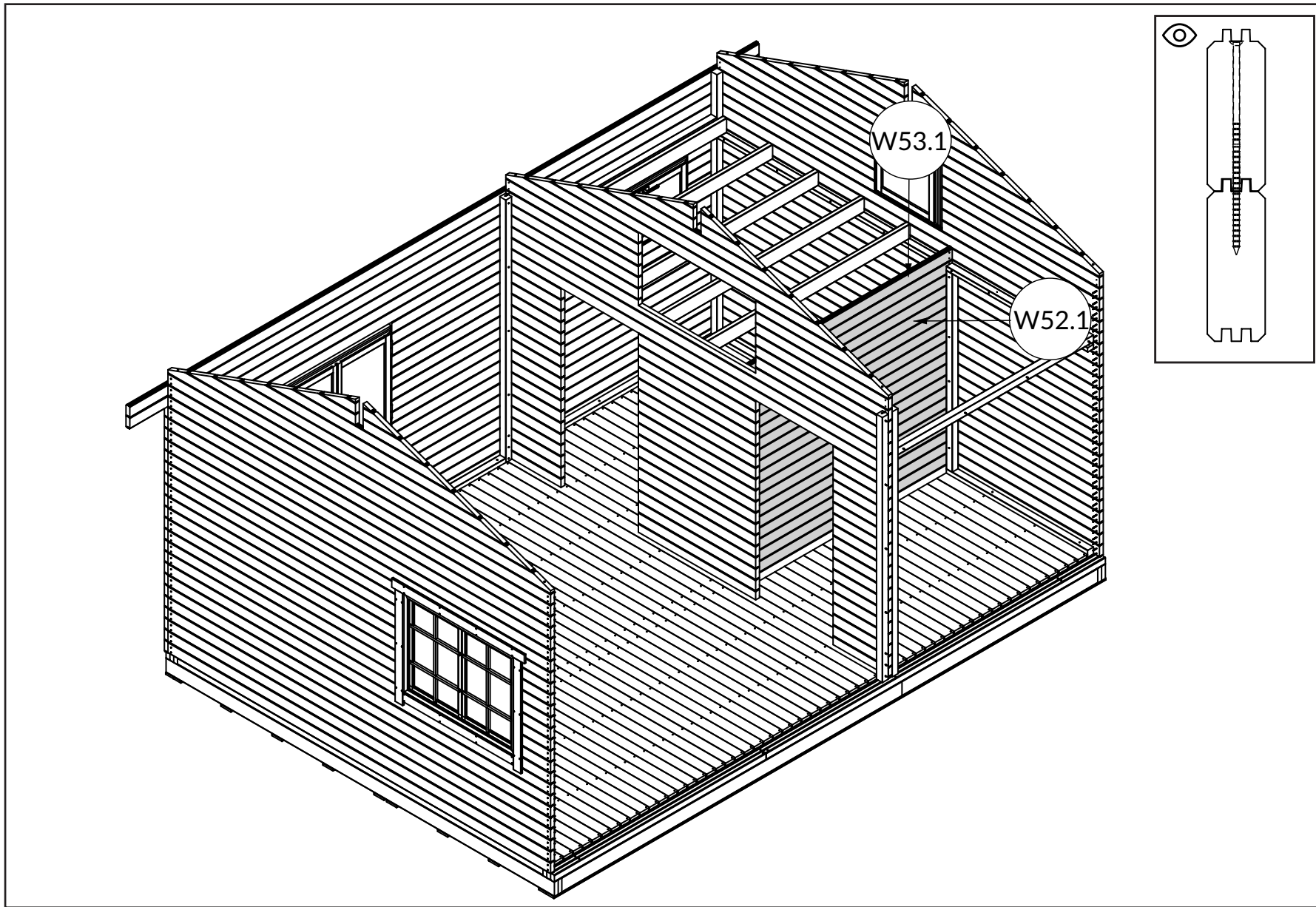

W52.1 x19

W53.1 x1

90mm

180mm

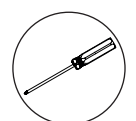
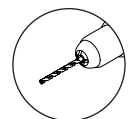
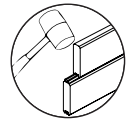

A|1→2→3→4→5→ B|1→2→3→4→5→6→7→8→9→10→11→12→13→14→15→16→17→18→19→20→
 C|1→2→3→4→5→6→7→8→9→ D|1→2→3→4→5→6→7→8→ E|1→2→3→4→5→6→7→
 F|1→2→3→4→5→6→7→ G|1→2→3→ H|1→2→3→ I|1→2→3→4→5→ J|1→2→3→4→

H3



I

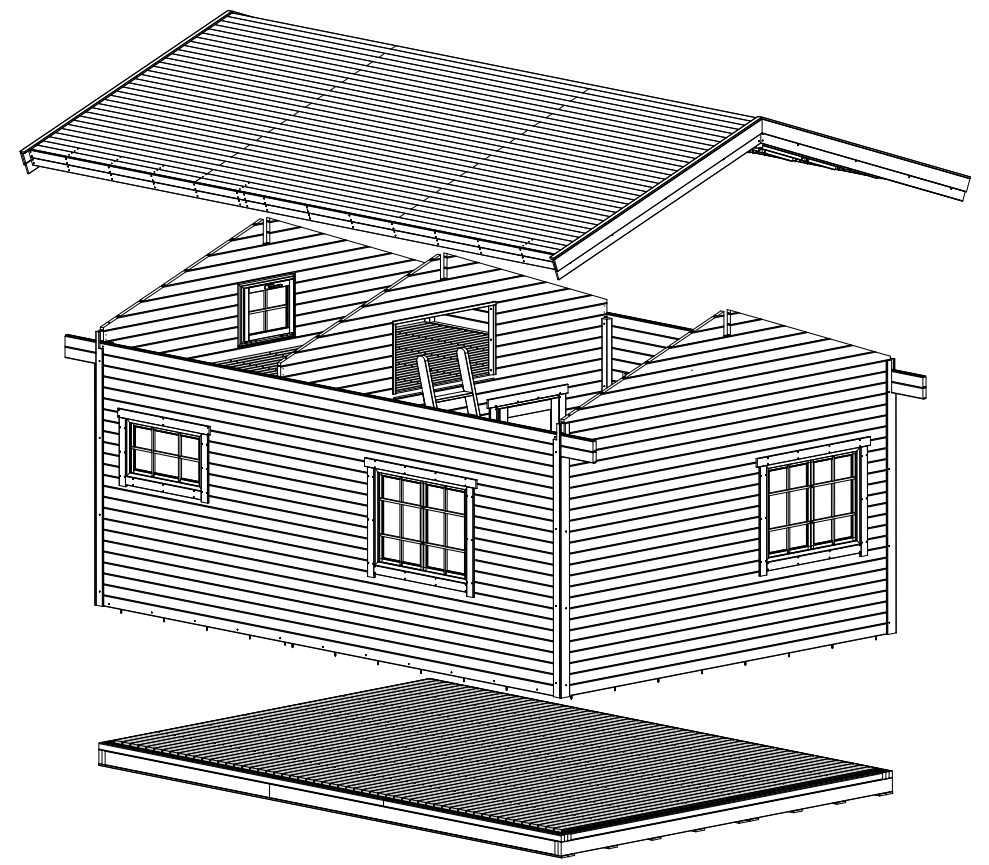
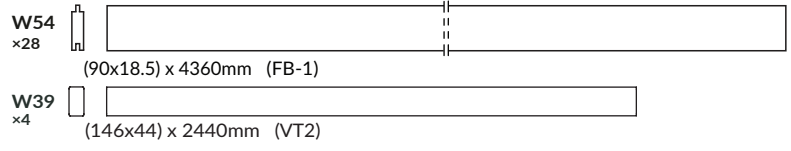

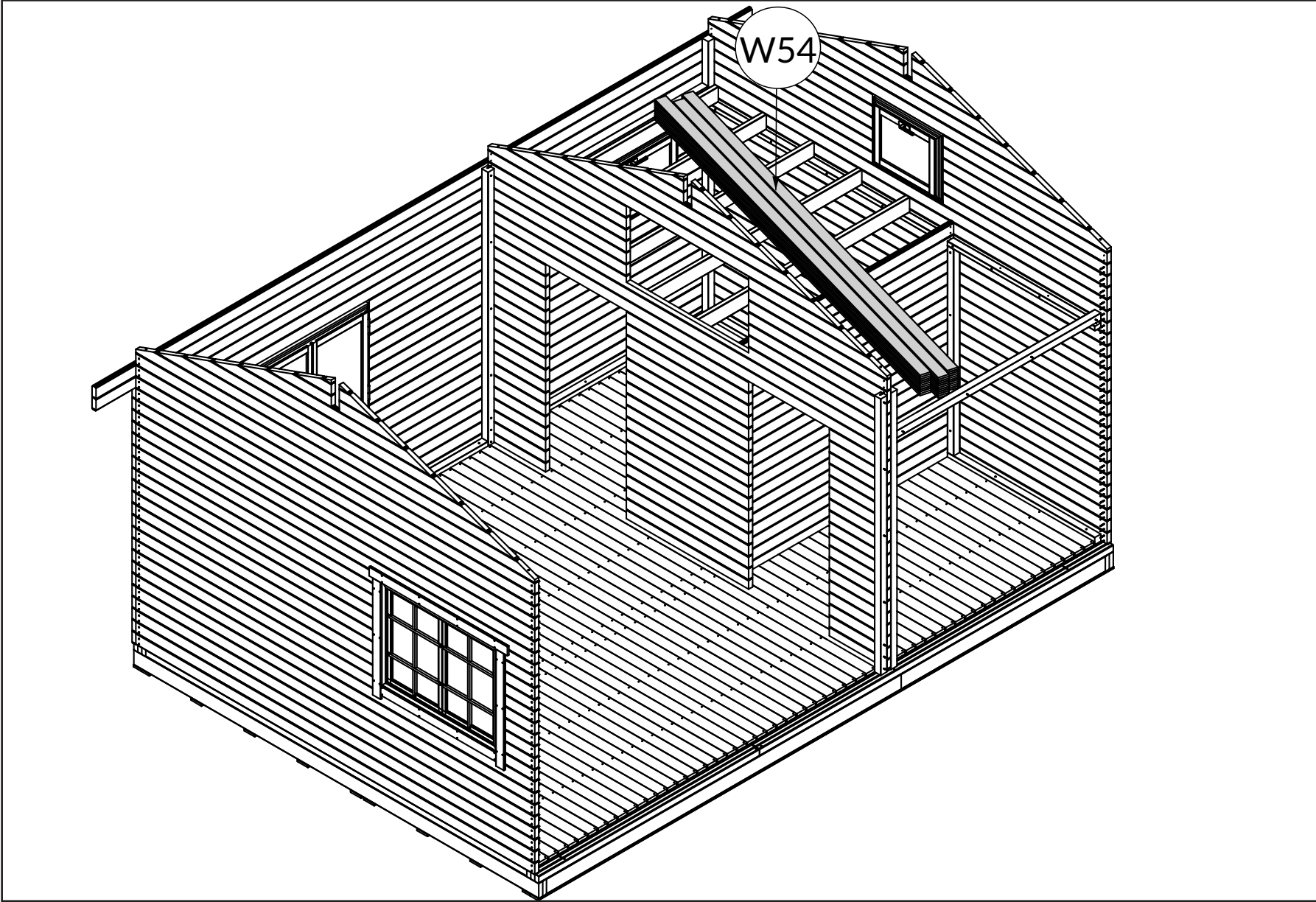

A|1→2→3→4→5→ B|1→2→3→4→5→6→7→8→9→10→11→12→13→14→15→16→17→18→19→20→
C|1→2→3→4→5→6→7→8→9→ D|1→2→3→4→5→6→7→8→ E|1→2→3→4→5→6→7→
F|1→2→3→4→5→6→7→ G|1→2→3→ H|1→2→3→ I|1→2→3→4→5→ J|1→2→3→4→

A|1→2→3→4→5→ B|1→2→3→4→5→6→7→8→9→10→11→12→13→14→15→16→17→18→19→20→
C|1→2→3→4→5→6→7→8→9→ D|1→2→3→4→5→6→7→8→ E|1→2→3→4→5→6→7→
F|1→2→3→4→5→6→7→ G|1→2→3→ H|1→2→3→ I|1→2→3→4→5→ J|1→2→3→4→

12

W39.1 x1

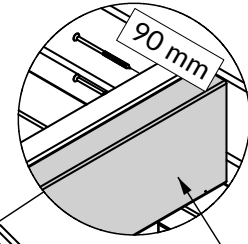
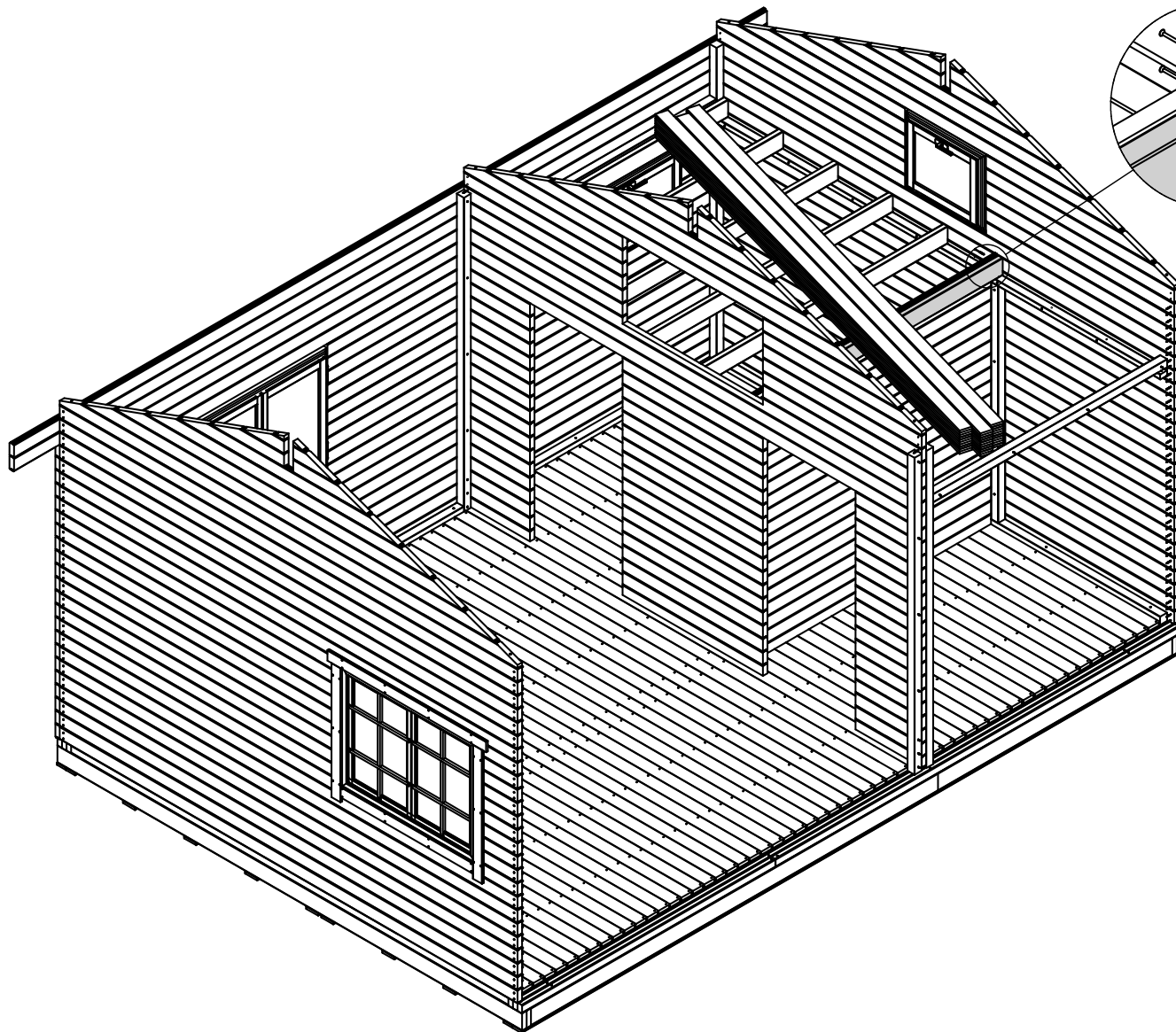

W39.1



90mm

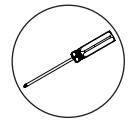
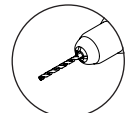

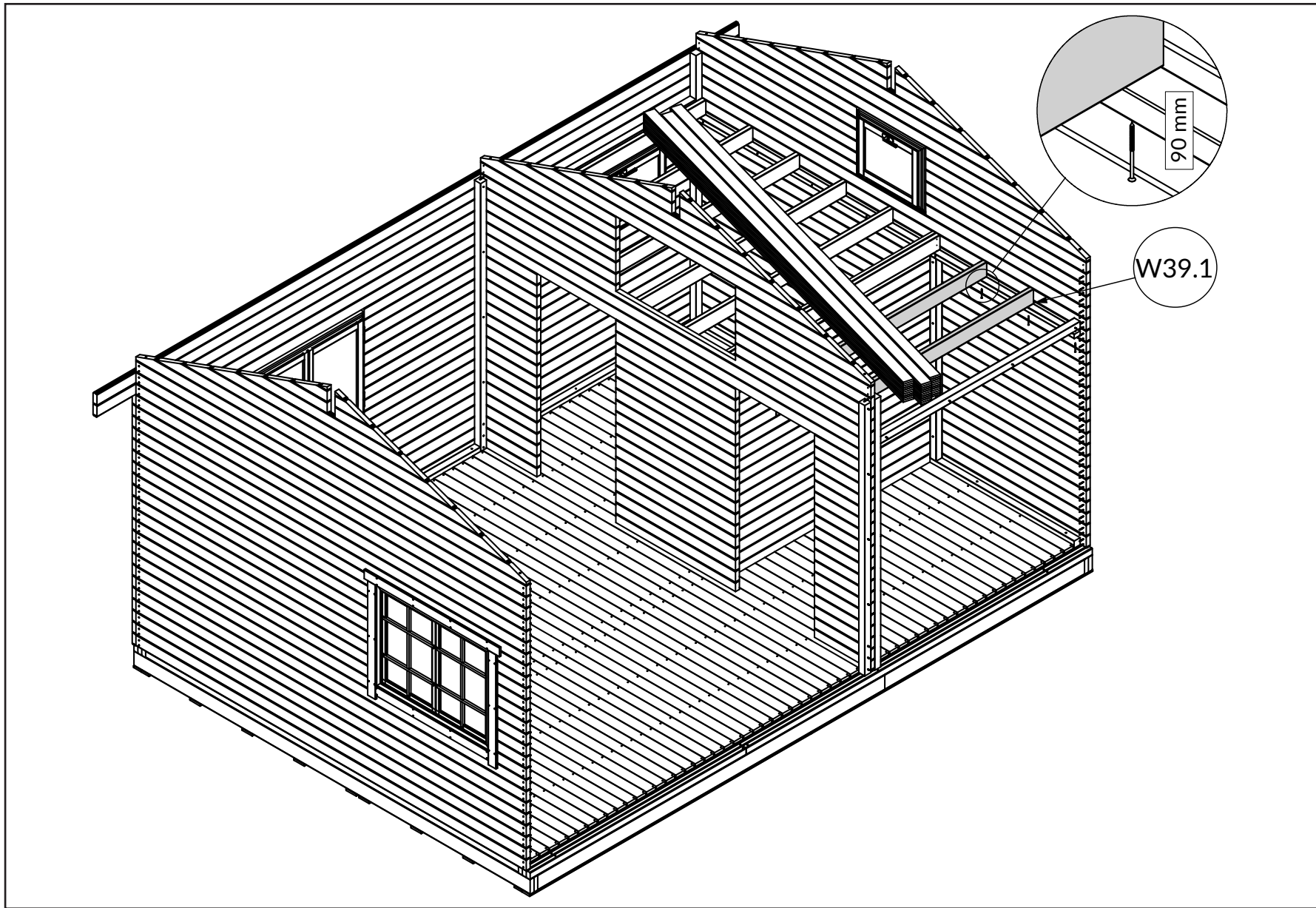

W39.1 x3

W39.1

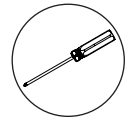
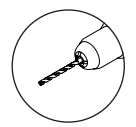
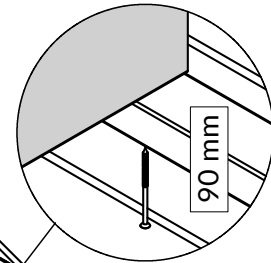

A|1→2→3→4→5→ B|1→2→3→4→5→6→7→8→9→10→11→12→13→14→15→16→17→18→19→20→
 C|1→2→3→4→5→6→7→8→9→ D|1→2→3→4→5→6→7→8→ E|1→2→3→4→5→6→7→
 F|1→2→3→4→5→6→7→ G|1→2→3→ H|1→2→3→ I|1→2→3→4→5→ J|1→2→3→4→

13

A|1→2→3→4→5→ B|1→2→3→4→5→6→7→8→9→10→11→12→13→14→15→16→17→18→19→20→
C|1→2→3→4→5→6→7→8→9→ D|1→2→3→4→5→6→7→8→ E|1→2→3→4→5→6→7→
F|1→2→3→4→5→6→7→ G|1→2→3→ H|1→2→3→ I|1→2→3→4→5→ J|1→2→3→4→

14

W54 x1

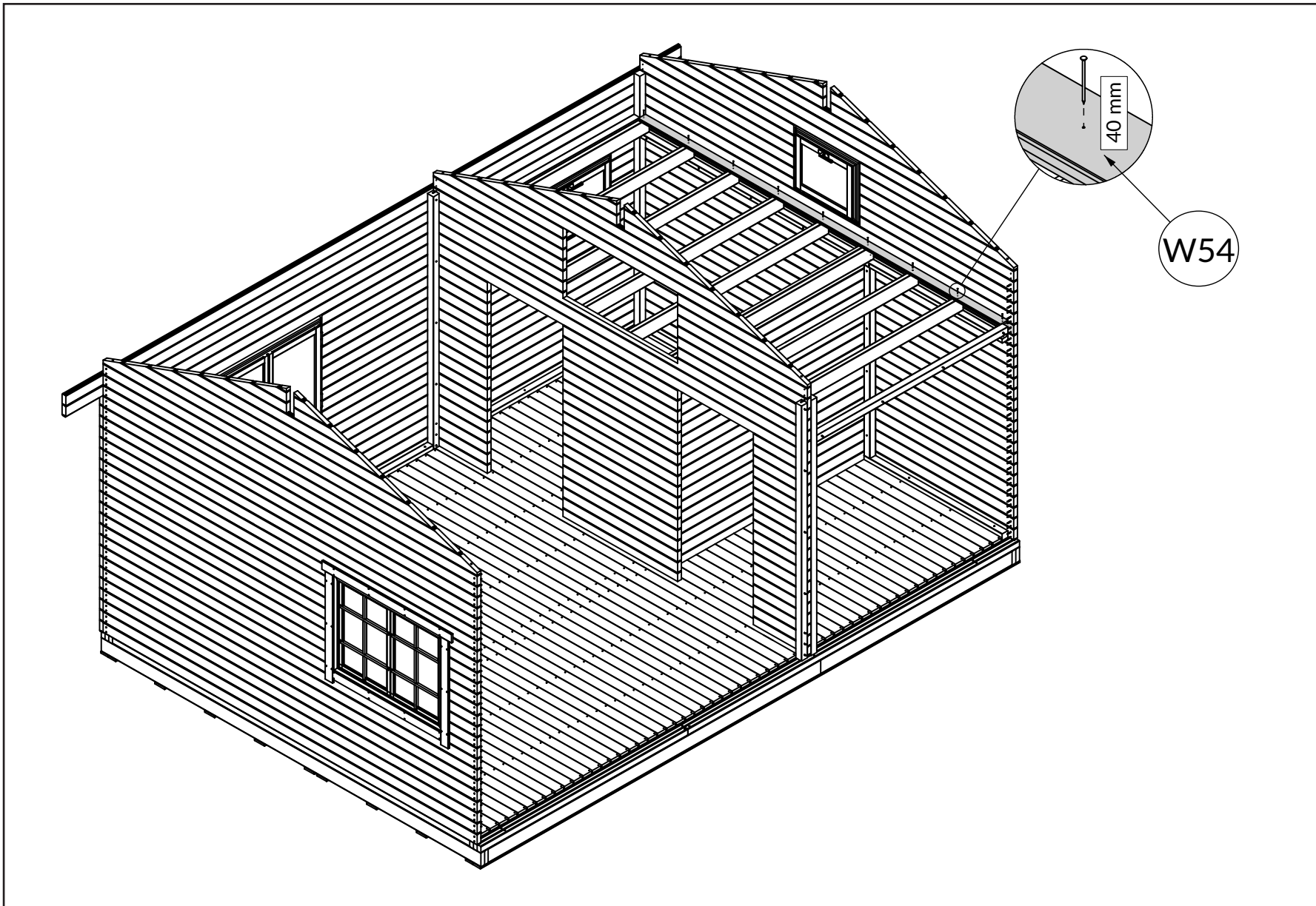

W54

50 mm



W54 x28

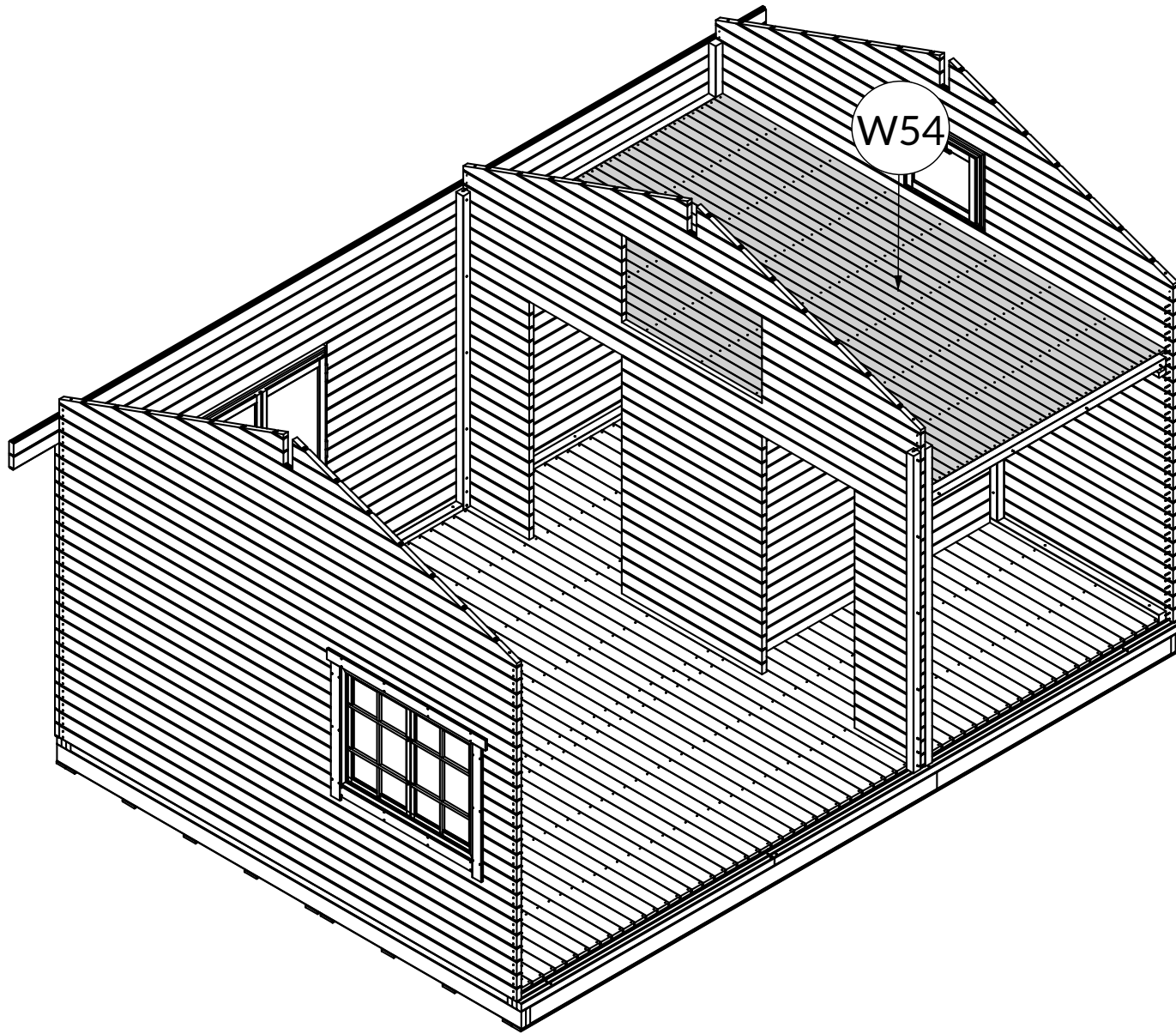

50mm





A|1→2→3→4→5→ B|1→2→3→4→5→6→7→8→9→10→11→12→13→14→15→16→17→18→19→20→
C|1→2→3→4→5→6→7→8→9→ D|1→2→3→4→5→6→7→8→ E|1→2→3→4→5→6→7→
F|1→2→3→4→5→6→7→ G|1→2→3→ H|1→2→3→ I|1→2→3→4→5→ J|1→2→3→4→

15

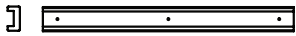
J

W55
x2

(70x35) x 740mm (UT-1)

W56
x1

(70x35) x 1400mm (UT-2)

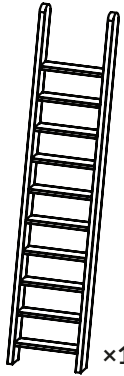
W57
x4

(120x18) x 2850mm (RS2)

W58
x4

(120x18) x 2850mm (RS1)



x1



x1



x1



50mm

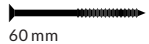

60mm

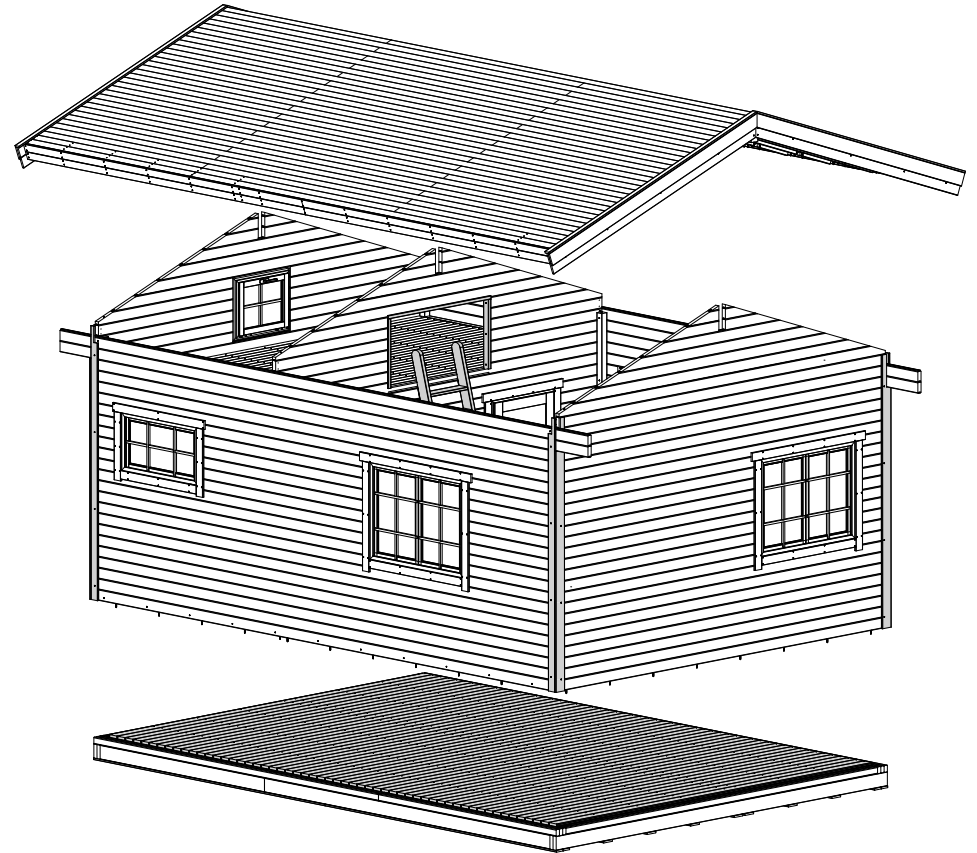

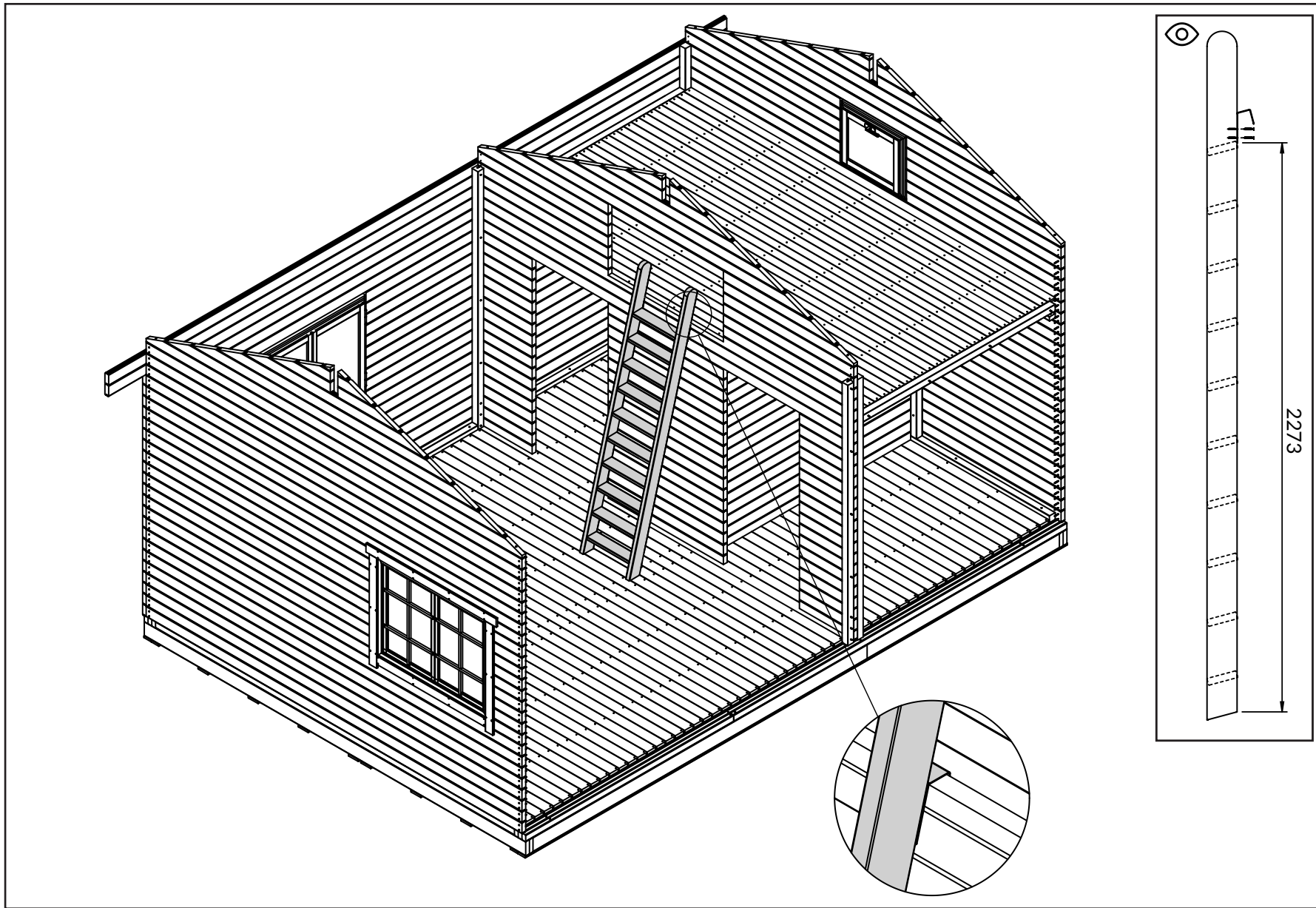

A|1→2→3→4→5→ B|1→2→3→4→5→6→7→8→9→10→11→12→13→14→15→16→17→18→19→20→
 C|1→2→3→4→5→6→7→8→9→ D|1→2→3→4→5→6→7→8→ E|1→2→3→4→5→6→7→
 F|1→2→3→4→5→6→7→ G|1→2→3→ H|1→2→3→ I|1→2→3→4→5→ J|1→2→3→4→

J1

J2

A|1→2→3→4→5→ B|1→2→3→4→5→6→7→8→9→10→11→12→13→14→15→16→17→18→19→20→
C|1→2→3→4→5→6→7→8→9→ D|1→2→3→4→5→6→7→8→ E|1→2→3→4→5→6→7→
F|1→2→3→4→5→6→7→ G|1→2→3→ H|1→2→3→ I|1→2→3→4→5→ J|1→2→3→4→

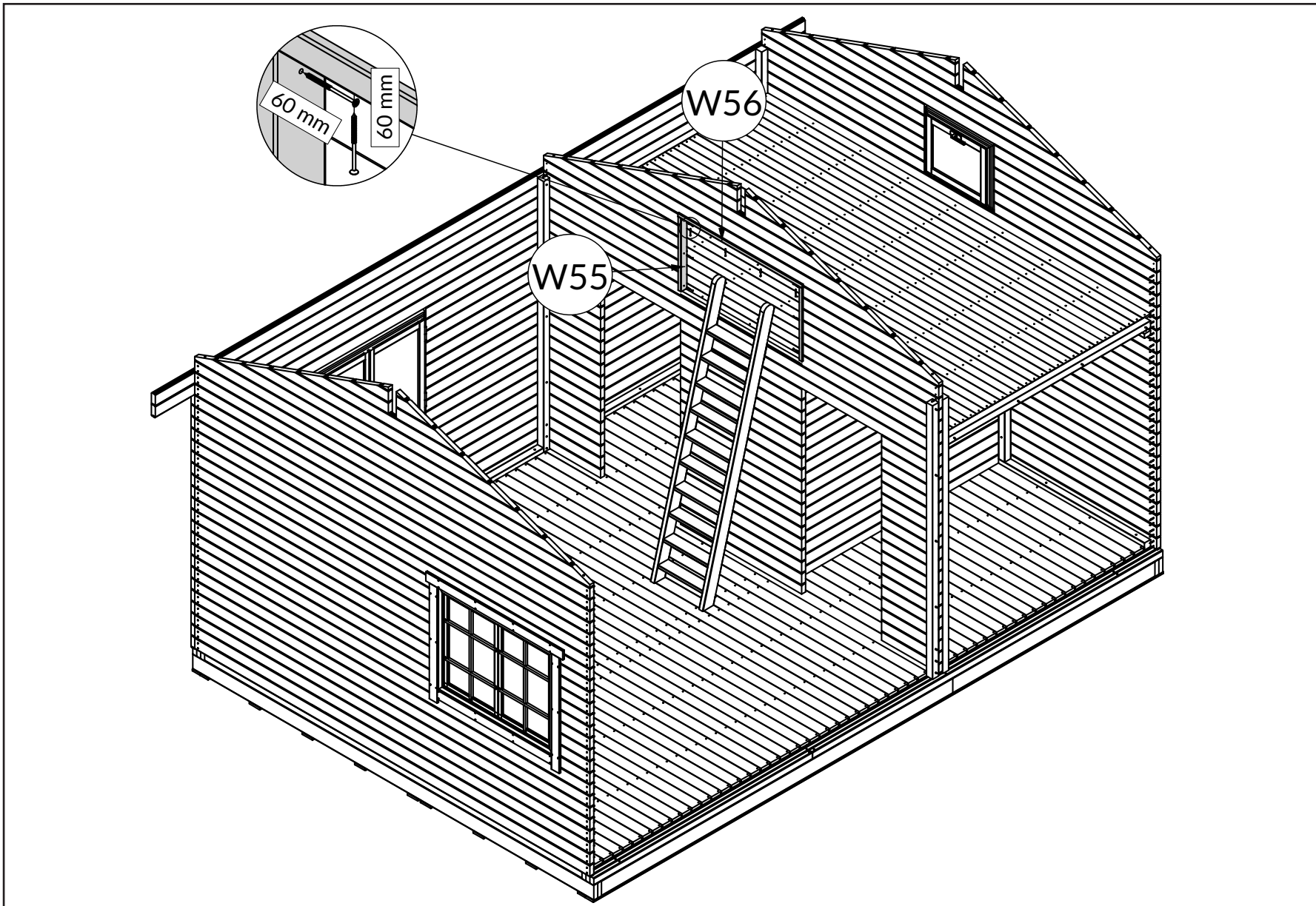

W55 x2

W56 x1

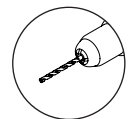
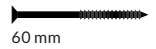

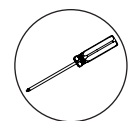
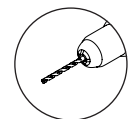
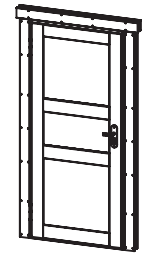
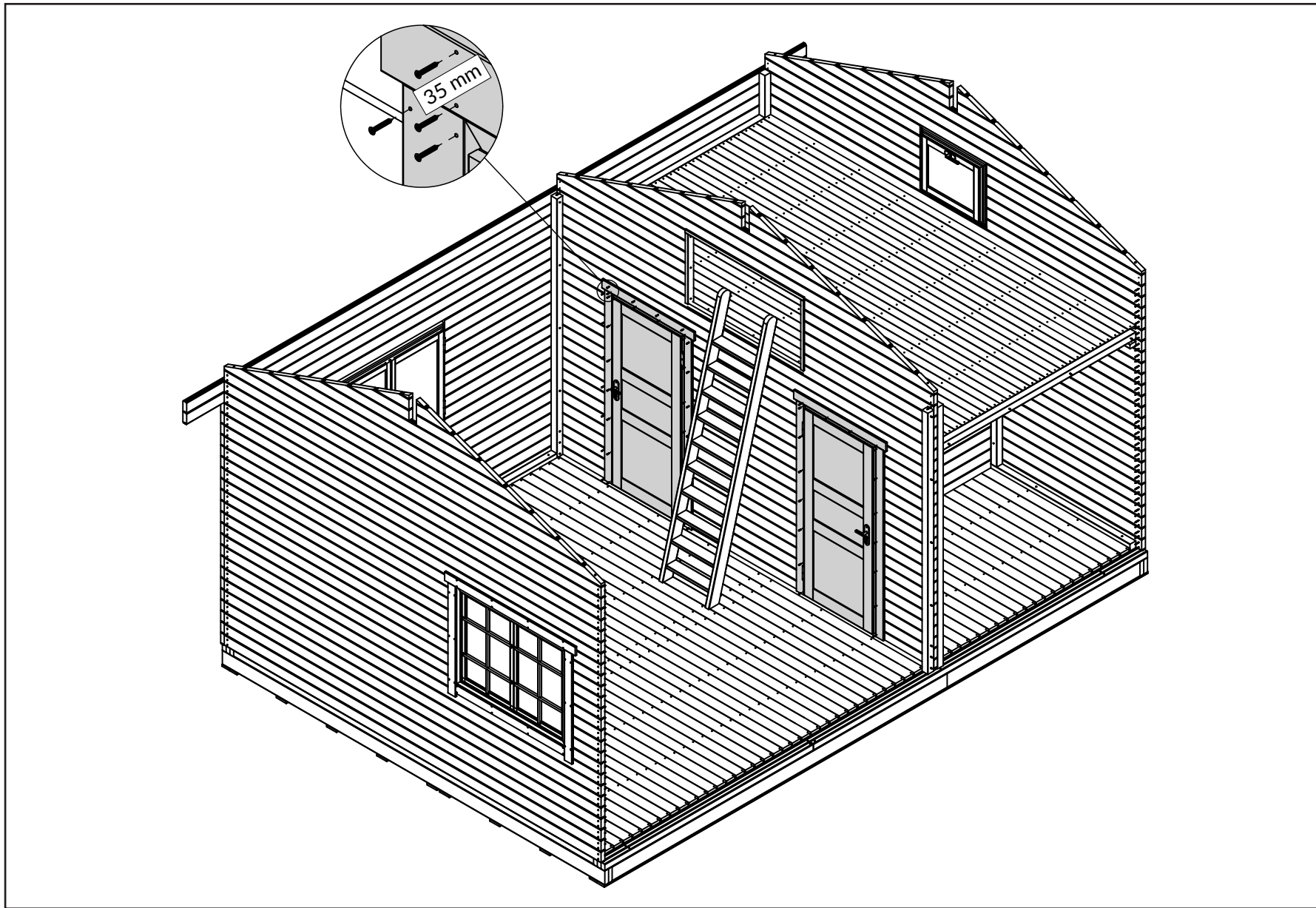

A|1→2→3→4→5→ B|1→2→3→4→5→6→7→8→9→10→11→12→13→14→15→16→17→18→19→20→
 C|1→2→3→4→5→6→7→8→9→ D|1→2→3→4→5→6→7→8→ E|1→2→3→4→5→6→7→
 F|1→2→3→4→5→6→7→ G|1→2→3→ H|1→2→3→ I|1→2→3→4→5→ J|1→2→3→4→

J3

J4

A|1→2→3→4→5→ B|1→2→3→4→5→6→7→8→9→10→11→12→13→14→15→16→17→18→19→20→
C|1→2→3→4→5→6→7→8→9→ D|1→2→3→4→5→6→7→8→ E|1→2→3→4→5→6→7→
F|1→2→3→4→5→6→7→ G|1→2→3→ H|1→2→3→ I|1→2→3→4→5→ J|1→2→3→4→

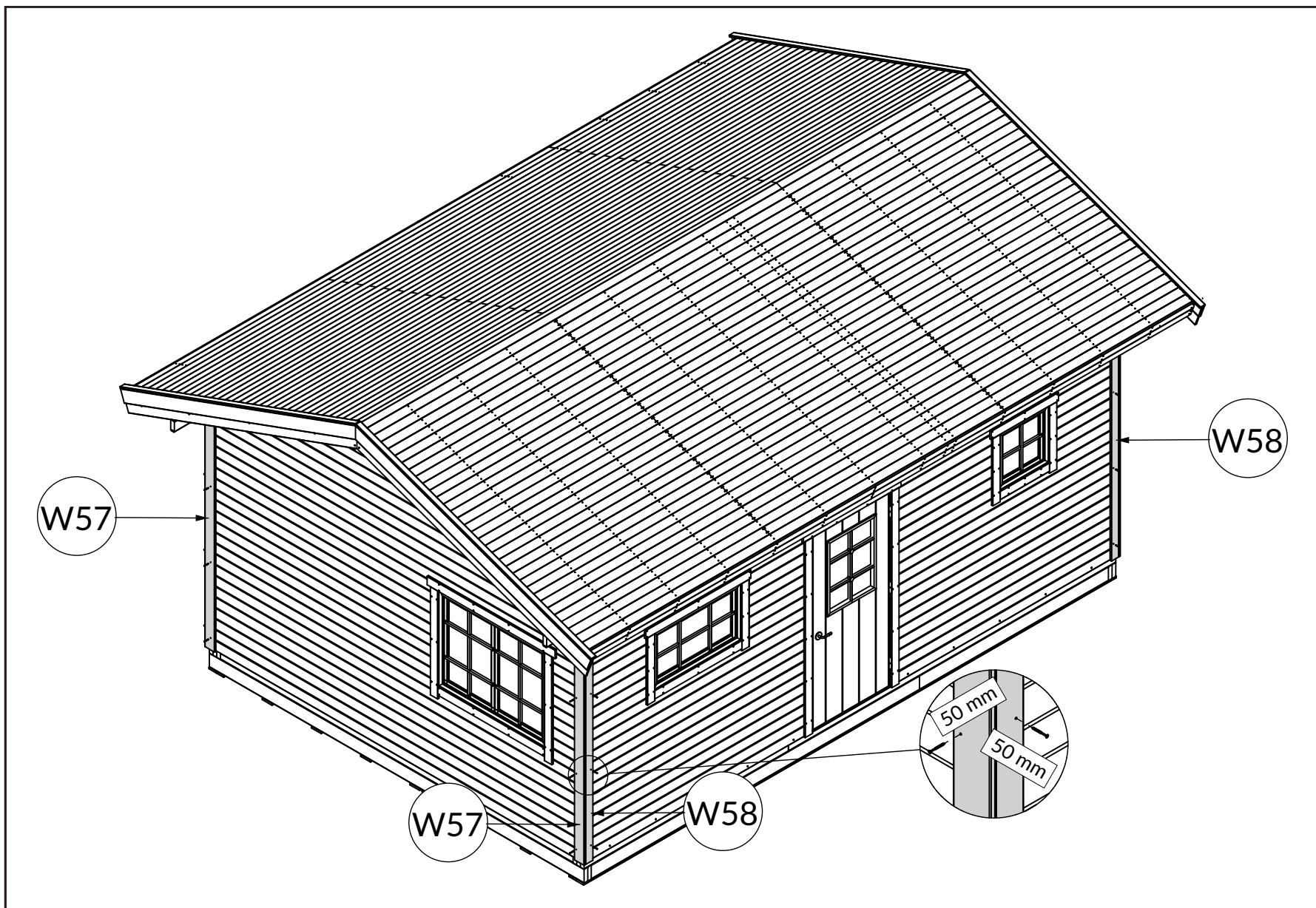

W57 x4

W58 x4

50 mm

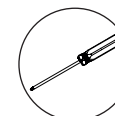
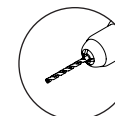

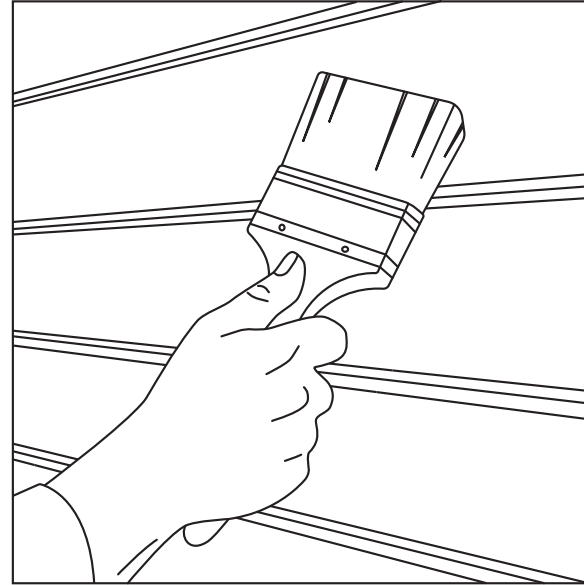
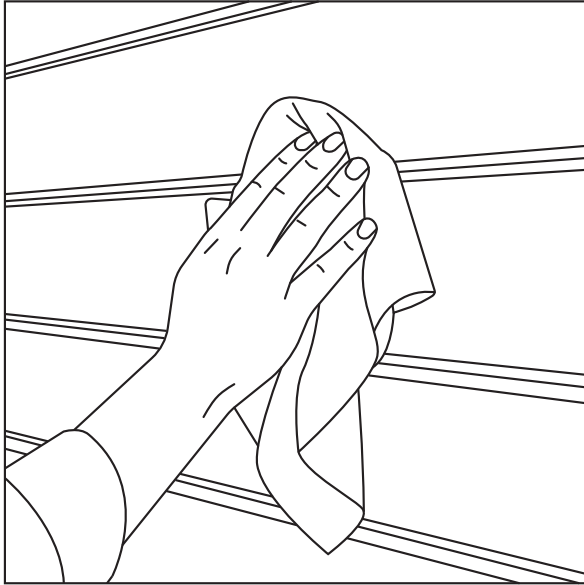

polhus.com



Polhus was founded in Mora, a small town in the heart of Sweden, known for its craftsmanship tradition. We build wooden houses and saunas to bring joy, laughter and shared moments into your home and everyday life.

Crafting MOMENTS