

# OTTO

P6546/44-OTTO-UFD | Revision 1.0

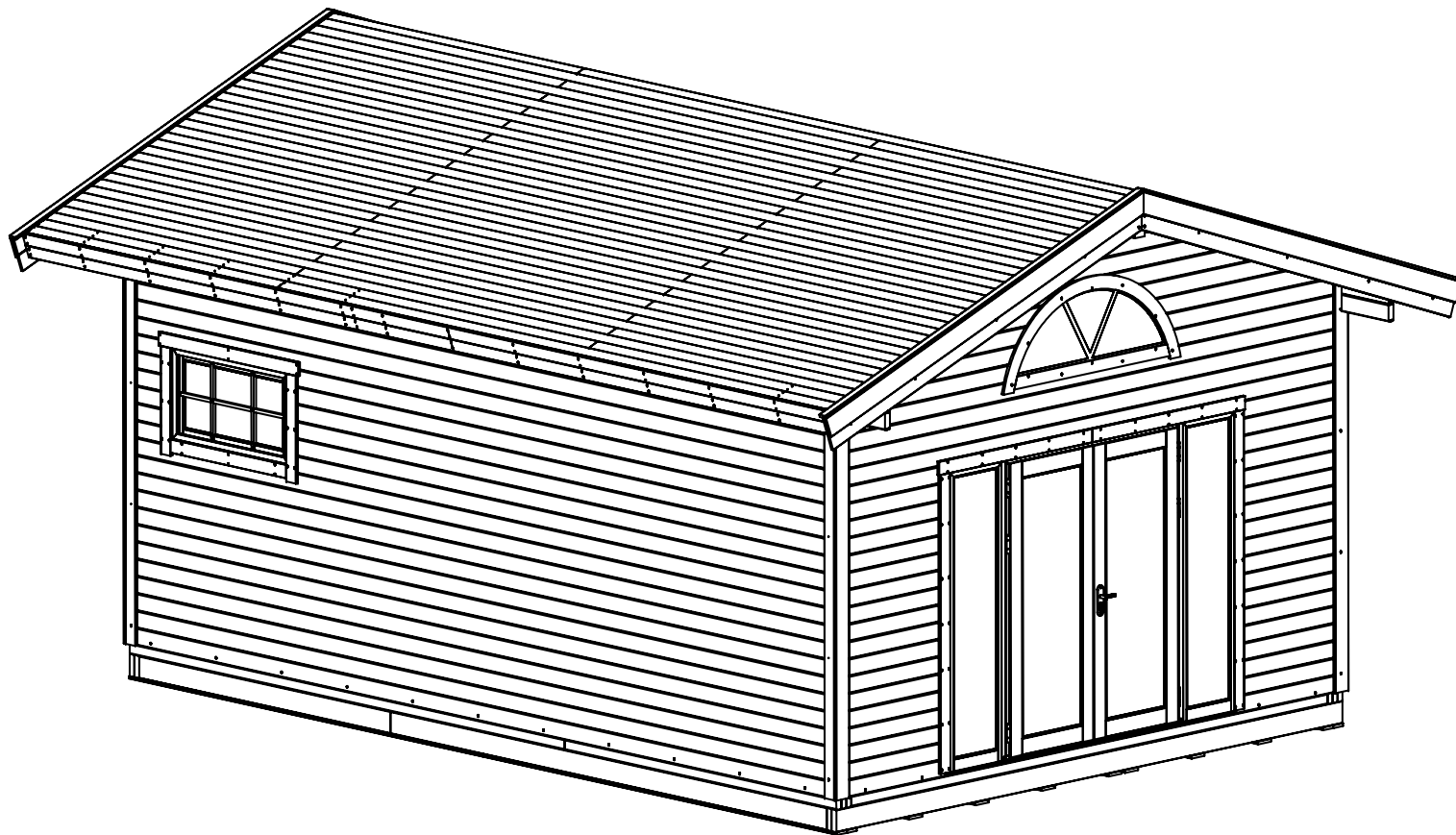

#ID

---

EN

## Read and understand the instruction manual before starting installation.

Our products are manufactured using premium quality timber. Strict selection processes ensure that all timber is cut and planed to the correct specifications. However, wood is a natural material and will experience changes in both appearance and composition throughout its life cycle.

This means that it may develop openings in the wood structure following the grain, including gaps, apertures, cracks, and splits. These gaps are expected during drier and wetter seasons. This is not a cause for concern and will not affect the structural integrity or the product's guarantee.

### Always remember:

- Pre-drill the indicated holes.
- Unpacking and assembly should be done by at least two people to avoid accidents.
- Wear gloves and safety glasses.
- Prepare a firm, level foundation before assembly.

For more information, you will find the general manual and our general terms and conditions at [www.polhus.com](http://www.polhus.com)

DE

## Bitte lesen und verstehen Sie die Bedienungsanleitung vollständig, bevor Sie mit der Installation beginnen.

Unsere Produkte bestehen aus hochwertigem Holz. Durch strenge Auswahlprozesse stellen wir sicher, dass das Holz gemäß den festgelegten Spezifikationen geschnitten und gehobelt wird. Da Holz ein Naturmaterial ist, unterliegt es im Laufe der Zeit optischen und strukturellen Veränderungen.

- Entlang der Maserung können sich Risse, Spalten und Öffnungen bilden.
- Diese Veränderungen sind natürliche Reaktionen auf wechselnde Feuchtigkeits- und Klimabedingungen.
- Sie beeinträchtigen weder die strukturelle Stabilität noch die Garantie des Produkts.

### Wichtige Montagehinweise:

- Bohren Sie stets die angegebenen Löcher vor.
- Das Auspacken und die Montage sollten aus Sicherheitsgründen von mindestens zwei Personen durchgeführt werden.
- Tragen Sie während der Montage geeignete Schutzausrüstung, einschließlich Handschuhen und Schutzbrille.
- Bereiten Sie vor der Montage eine stabile und ebene Grundlage vor.

Detaillierte Informationen finden Sie im allgemeinen Handbuch sowie in unseren Geschäftsbedingungen unter [www.polhus.com](http://www.polhus.com)

FR

## Lisez attentivement le manuel d'instruction avant de commencer l'installation.

Nos produits sont fabriqués en bois de haute qualité, soigneusement sélectionné, coupé et raboté selon des spécifications précises. Cependant, le bois étant un matériau naturel, il évolue au fil du temps, tant dans son apparence que dans sa structure.

Des fissures, interstices et fentes peuvent apparaître le long des veines du bois en fonction des variations saisonnières d'humidité. Ces phénomènes sont normaux et n'affectent ni la solidité du produit ni sa garantie.

### Consignes importantes :

- Percez toujours les trous prévus à l'avance.
- Le déballage et le montage doivent être réalisés par au moins deux personnes pour éviter tout risque d'accident.
- Portez des gants et des lunettes de protection.
- Assurez-vous de préparer une base stable et parfaitement nivelée avant de commencer l'assemblage.

Pour plus d'informations, consultez le manuel général ainsi que nos conditions générales sur la page web de votre pays : [www.polhus.com](http://www.polhus.com)

NL

## Lees en begrijp de handleiding voordat u met de installatie begint.

Alle producten worden vervaardigd van hoogwaardig hout. Strenge selectieprocessen zorgen ervoor dat al het hout volgens de juiste specificaties wordt gezaagd en geschaafd. Hout is echter een natuurlijk materiaal en zal gedurende zijn levenscyclus veranderingen ondergaan in zowel uiterlijk als samenstelling.

Dit betekent dat er openingen kunnen ontstaan in de houtstructuur langs de nerf, zoals spleten, barsten en scheuren. Deze veranderingen zijn normaal tijdens zowel droge als vochtige seizoenen. Dit is geen reden tot bezorgdheid en heeft geen invloed op de structurele integriteit of de garantie van het product.

### Onthoud altijd:

- Boor altijd de aangegeven gaten voor.
- Het uitpakken en monteren dient door minimaal twee personen te worden uitgevoerd om ongelukken te voorkomen.
- Draag handschoenen en een veiligheidsbril.
- Zorg voor een stevige en vlakke ondergrond voordat u met de montage begint.

Voor meer informatie vindt u de algemene handleiding en onze algemene voorwaarden op de website: [www.polhus.com](http://www.polhus.com)

PL

## Przeczytaj i upewnij się, że rozumiesz instrukcję przed rozpoczęciem instalacji.

Nasze produkty powstają z doskonałej jakości materiałów. Surowe procesy kontroli produkcji gwarantują cięcie i heblowanie zgodne z najwyższymi standardami. Należy jednak pamiętać, że drewno to naturalny surowiec, który stopniowo zmienia zarówno swój wygląd, jak i strukturę.

Wraz z upływem czasu na powierzchni desek i belek mogą pojawić się szczeliny, pęknięcia i rysy. Zmiany te są naturalne i zależne od natężenia wilgoci w różnych porach roku. Nie stanowią one powodu do niepokoju i nie wpływają na integralność konstrukcyjną ani gwarancję produktu.

### Pamiętaj o:

- wstępnym nawierceniu wszystkich wskazanych otworów;
- rozpakowaniu i montażu elementów przez co najmniej dwie osoby, aby uniknąć wypadków;
- noszeniu rękawic i okularów ochronnych;
- przygotowaniu solidnego i równego fundamentu przed rozpoczęciem montażu.

Więcej informacji, w tym ogólną instrukcję montażu oraz regulamin, znajdziesz na stronie internetowej [www.polhus.com](http://www.polhus.com)

SE

## Läs och förstå manualen innan du påbörjar installationen.

Alla våra produkter tillverkas av högkvalitativt trä. Strikta urvalsprocesser säkerställer att allt trä kapas och hyvlas utefter givna specifikationer. Trä är dock ett naturligt material och kommer att förändras både i utseende och sammansättning under sin livscykel.

Detta innebär att träet kan utveckla sprickor och öppningar längs fibrerna, inklusive glipor, springor och sprickbildning. Dessa variationer är normala under både torra och fuktiga perioder. Detta är inte något att oroa sig för och påverkar varken den strukturella hållfastheten eller produktens garanti.

### Kom ihåg att:

- Förborra alltid de angivna hålen.
- Uppackning och montering bör utföras av minst två personer för att undvika olyckor.
- Använd handskar och skyddsglasögon.
- Förbered en stabil och jämn grund innan montering.

För mer information hittar du den allmänna manualen och våra allmänna villkor på [www.polhus.com](http://www.polhus.com)

NO

## Les og forstå bruksanvisningen før du starter installasjonen.

Alle produkter er laget av trevirke av høy kvalitet. Strenge utvalgsriterier sikrer at alt treverk blir kuttet og høvlet i henhold til riktige spesifikasjoner. Tre er imidlertid et naturlig materiale og vil endre både utseende og sammensetning gjennom sin livssyklus.

Dette betyr at treet kan utvikle åpninger i strukturen langs årringene, inkludert sprekker, glipper og revner. Disse variasjonene er normale i både tørre og fuktige perioder. Dette er ikke noe å bekymre seg for og vil ikke påvirke den strukturelle integriteten eller produktets garanti.

### Husk å:

- Forbor alltid de angitte hullene.
- Oppakking og montering bør utføres av minst to personer for å unngå ulykker.
- Bruk handsker og vernebriller.
- Forbered et solid og jevnt fundament før montering.

For mer informasjon finner du den generelle manualen og våre generelle vilkår på [www.polhus.com](http://www.polhus.com)

DK

## Læs og forstå brugsanvisningen, før du påbegynder installationen.

Alle produkter er fremstillet af træ af høj kvalitet. Strenge udvælgelsesprocesser sikrer, at alt træ skæres og høvles i henhold til de korrekte specifikationer. Træ er dog et naturligt materiale og vil ændre både udseende og sammensætning gennem sin livscyklus.

Dette betyder, at træet kan udvikle åbninger i strukturen langs årerne, herunder sprækker, revner og mellemrum. Disse variationer er normale i både tørre og fugtige perioder. Dette er ikke grund til bekymring og påvirker hverken den strukturelle integritet eller produktets garanti.

### Husk at:

- Forbor altid de angivne huller.
- Udpakning og montering bør udføres af mindst to personer for at undgå ulykker.
- Brug handsker og sikkerhedsbriller.
- Forbered et fast og jævnt fundament inden montering.

For mere information finder du den generelle manual og vores generelle vilkår på [www.polhus.com](http://www.polhus.com)

## Lue ja ymmärrä käyttöohje ennen asennuksen aloittamista.

Kaikki tuotteet valmistetaan korkealaatuisesta puusta. Tiukat valintaprosessit varmistavat, että kaikki puu leikataan ja höylätään oikeiden spesifikaatioiden mukaisesti. Puu on kuitenkin luonnonmateriaali ja sen ulkonäkö sekä koostumus muuttuvat sen elinkaaren aikana.

Tämä tarkoittaa, että puuhun voi muodostua rakenteellisia avautumia syiden suuntaisesti, kuten rakoja, halkeamia ja uurteita. Nämä muutokset ovat normaaleja sekä kuivina että kosteina kausina. Tämä ei ole syy huoleen, eikä se vaikuta rakenteelliseen kestävyYTEEN tai tuotteen takuuseen.



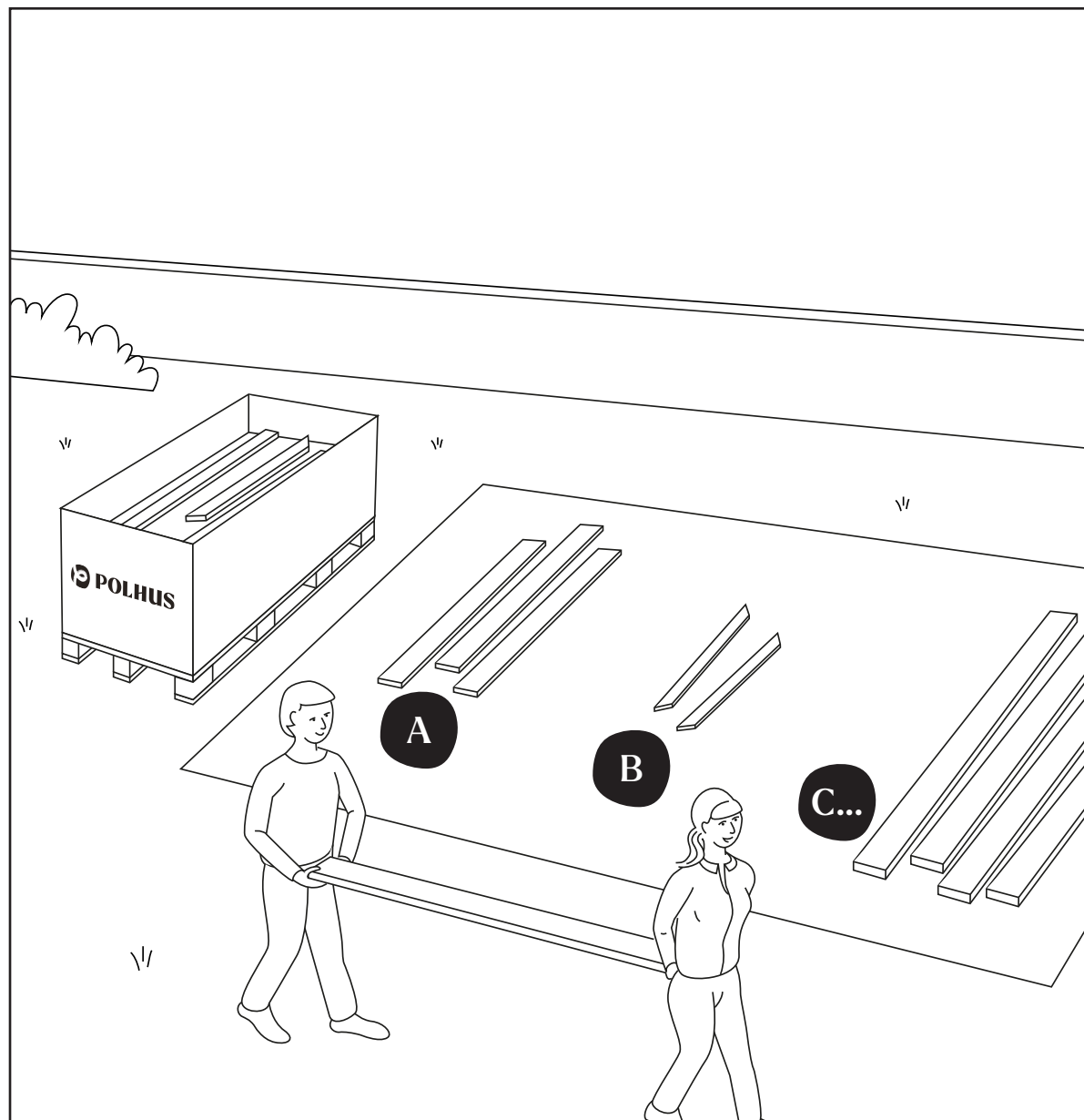
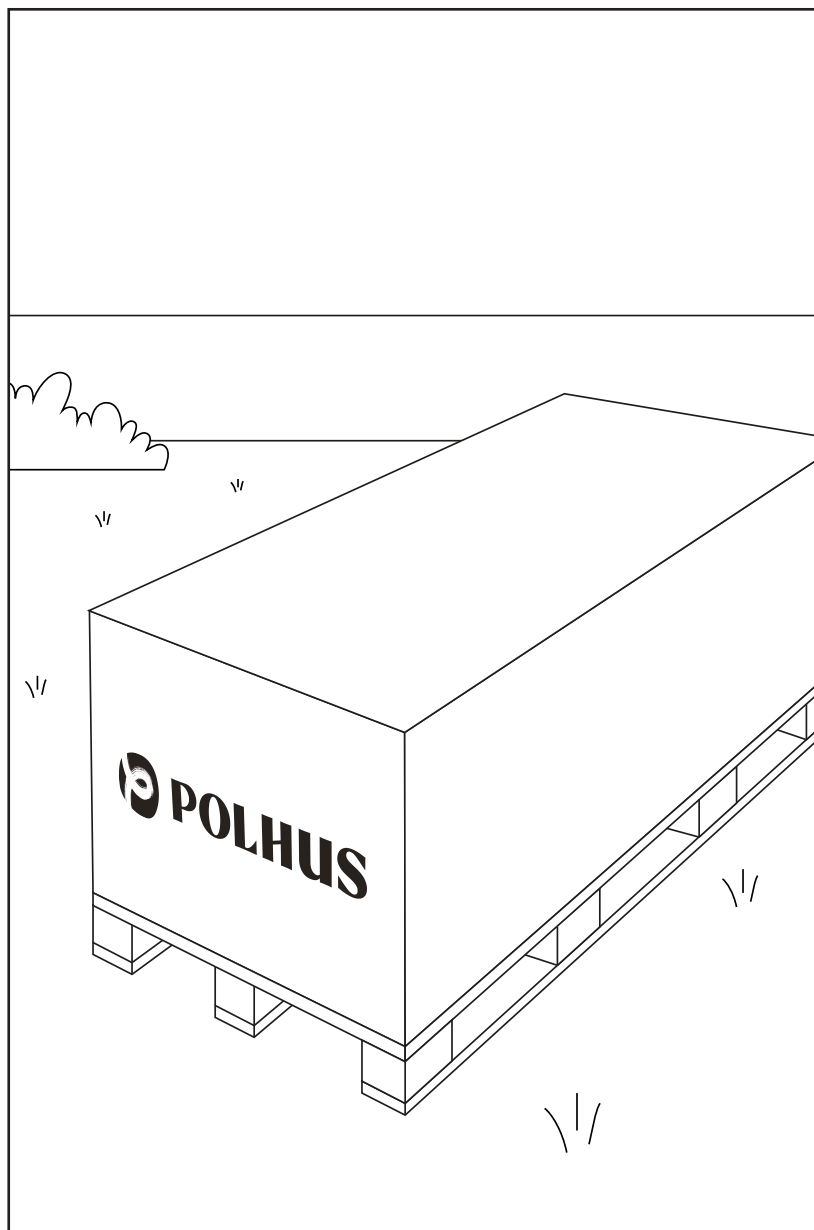

### **Muista että:**

- Esiporaa aina merkityt reiät.
- Pakkauksen purkaminen ja kokoaminen tulisi suorittaa vähintään kahden henkilön voimin tapaturmien välttämiseksi.
- Käytä käsineitä ja suojalaseja.
- Valmisteleva ja tasainen perusta ennen kokoamista.



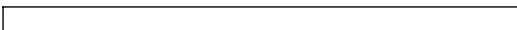
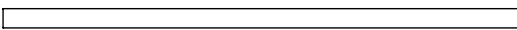

Lisätietoja löydät yleisestä käyttöoppaasta ja yleisistä ehdoistamme kunkin maan verkkosivustolta osoitteessa [www.polhus.com](http://www.polhus.com)

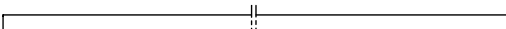
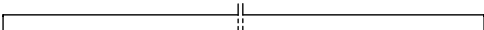
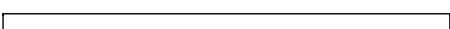
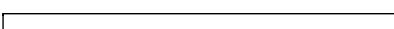



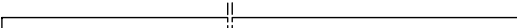
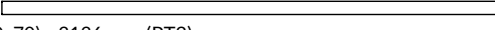

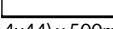

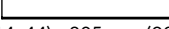



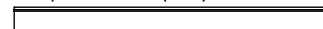

# A

- W1    
 x14 (120x18) x 3240mm (IAR2)
- W2    
 x8 (90x18) x 3240mm (IAR1)
- W3    
 x13 (146x44) x 4000mm (AR4)
- W4    
 x13 (146x44) x 2304mm (AR6)
- W5    
 x4 (146x44) x 4568mm (AR1)
- W6    
 x4 (70x45) x 4298mm (AR2)
- W7    
 x13 (70x45) x 4000mm (AR5)
- W8    
 x6 (70x45) x 2480mm (AR3)
- W9    
 x7 (70x45) x 2300mm (AR7)

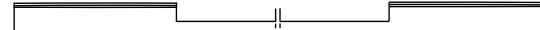
# B

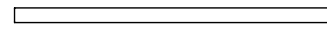
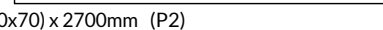
- W10    
 x4 (70x70) x 4360mm (PT1)
- W11    
 x4 (70x70) x 3136mm (PT2)
- W12    
 x33 (114x44) x 6500mm (001)
- W13    
 x12 (114x44) x 500mm (002)
- W14    
 x6 (114x44) x 3395mm (003)
- W15    
 x6 (114x44) x 805mm (004)

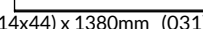
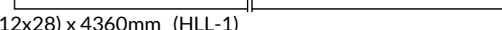
- W16    
 x4 (114x44) x 7412mm (005)
- W17    
 x36 (114x44) x 935mm (012)
- W18    
 x6 (114x44) x 4870mm (008)
- W19    
 x27 (114x44) x 4500mm (013)
- W20    
 x2 (114x44) x 1578mm (014)
- W21    
 x2 (114x44) x 1645mm (015)
- W22    
 x2 (114x44) x 1745mm (016)
- W23    
 x8 (114x44) x 1853mm (025)
- W24    
 x2 (86x44) x 650mm (028)
- W25    
 x1 (86x44) x 1380mm (029)
- W26    
 x1 (114x44) x 4500mm (032)
- W27    
 x8 (114x44) x 1560mm (033)
- W28    
 x1 (70x70) x 2061mm (P1)
- W29    
 x8 (70x70) x 2700mm (P2)
- W30    
 x34 (114x44) x 650mm (030)
- W31    
 x17 (114x44) x 1380mm (031)
- W32    
 x1 (112x28) x 4360mm (HLL-1)

- W33 (WA-1)    
 x1



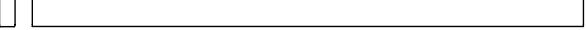
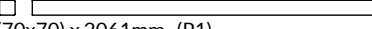
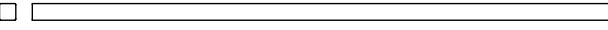

- W34 (WC-1)    
 x1

- W35 (WB-1)    
 x1



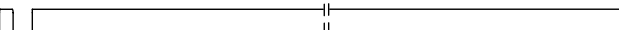

# C

- W36    
 x2 (70x45) x 4360mm (VT1)
- W37    
 x5 (146x44) x 2440mm (VT2)
- W28    
 x1 (70x70) x 2061mm (P1)
- W11    
 x2 (70x70) x 3136mm (PT2)

# D

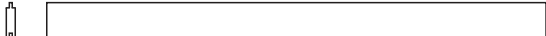
- W38    
 x1 (270x90) x 7412mm (A-PR1)
- W39    
 x30 (170x44) x 2900mm (SR1)
-    
 x48
- W40    
 x4 (114x44) x 456mm (006)
- W41    
 x22 (114x44) x 555mm (007)

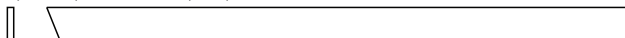
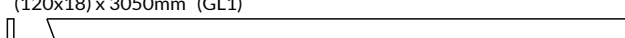
# E

- W42  
x66  (90x18.5) x 5093mm (RB-1)
- W43  
x66  (90x18.5) x 2319mm (RB-2)
- W44  
x4  (90x18) x 3517mm (TB1)
- W45  
x4  (90x18) x 3895mm (TB2)
- W46  
x8  (120x18) x 3050mm (GL1)
- W47  
x4  (140x18) x 3050mm (GL2)
- W48  
x4  (58x18) x 3050mm (RFF)

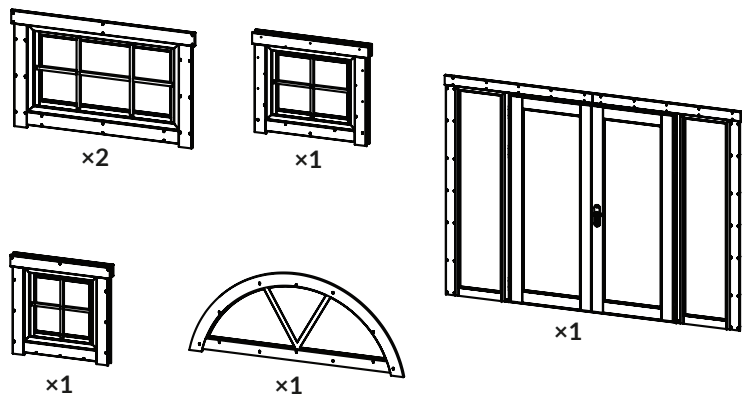

# F





# G

- W32  
x57  (112x28) x 4360mm (HLL-1)



# H

- W49  
x1  (86x44) x 2440mm (009)
- W50  
x18  (114x44) x 2440mm (010)
- W51  
x1  (114x44) x 2440mm (011)

# I

- W52  
x28  (90x18.5) x 4360mm (FB-1)
- W37  
x4  (146x44) x 2440mm (VT2)

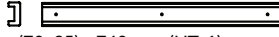
# J

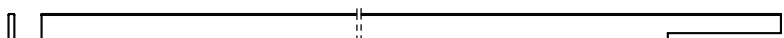
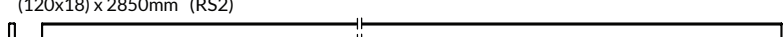
- W53  
x2  (70x35) x 740mm (UT-1)
- W54  
x1  (70x35) x 1400mm (UT-2)
- W55  
x4  (120x18) x 2850mm (RS2)
- W56  
x4  (120x18) x 2850mm (RS1)

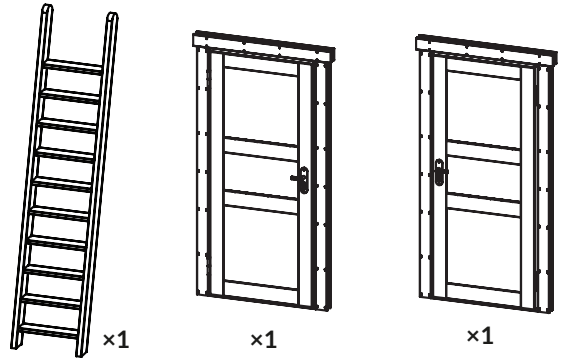

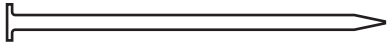

50mm ×1350

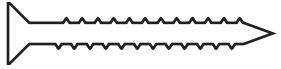

35 mm ×400

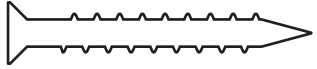

40 mm ×400

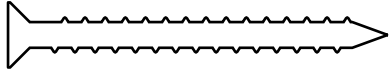

50 mm ×250

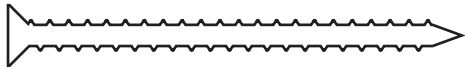

60 mm ×40



70 mm ×500

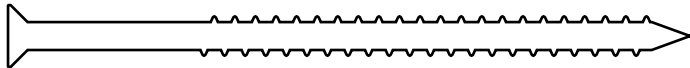

90 mm ×1000

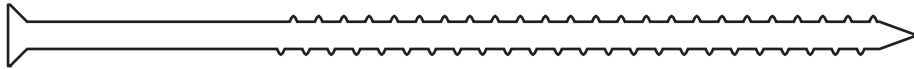

120 mm ×60



180 mm ×250

**1:1**



=

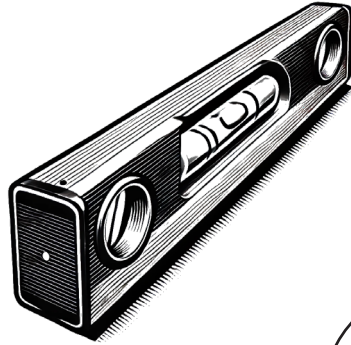
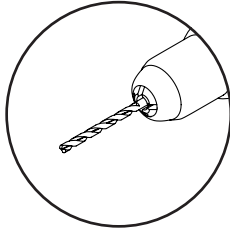

=

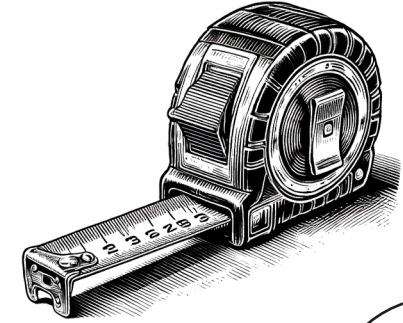
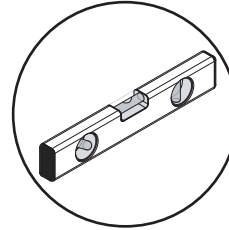

=

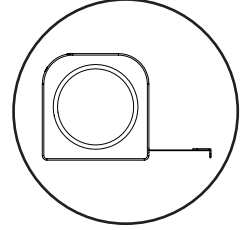

=

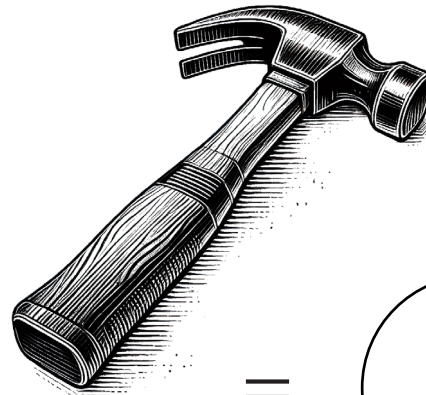
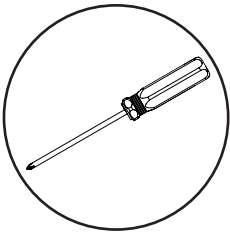

=

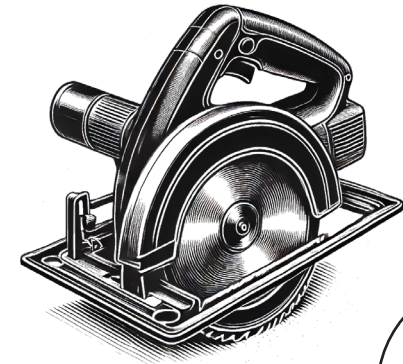
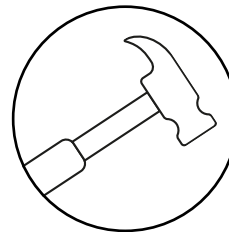

=

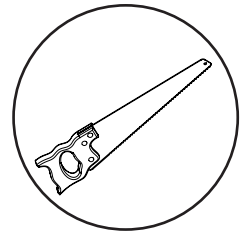

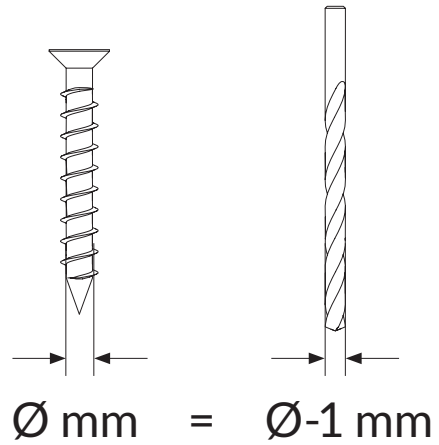
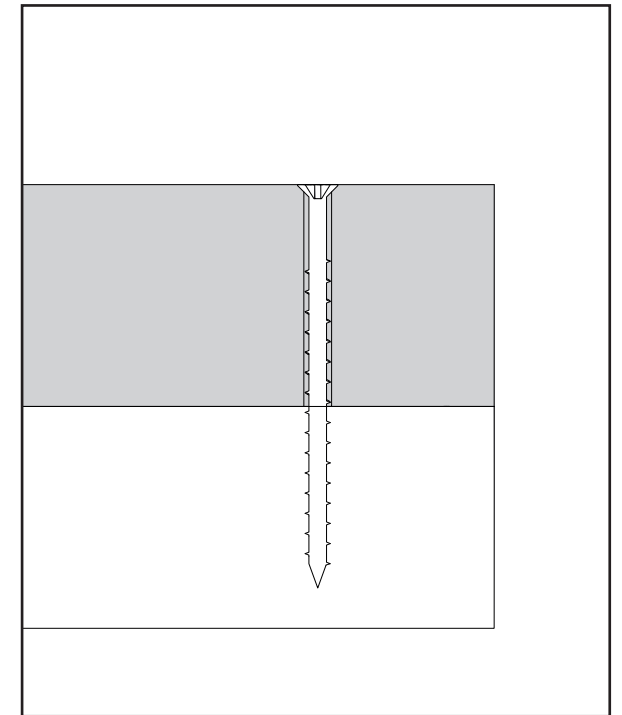
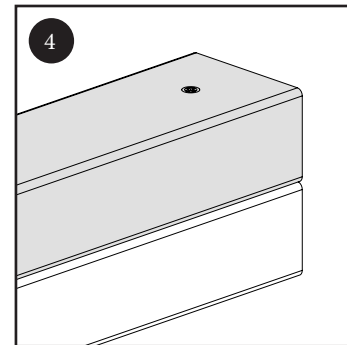
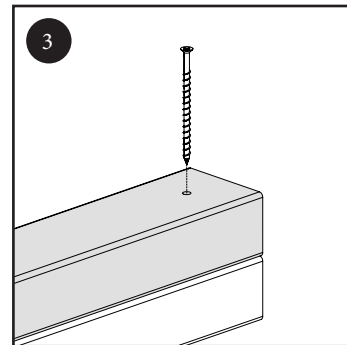
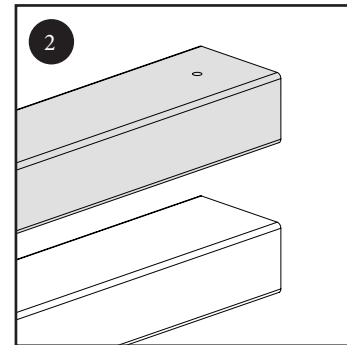
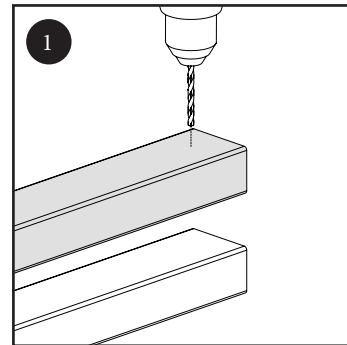
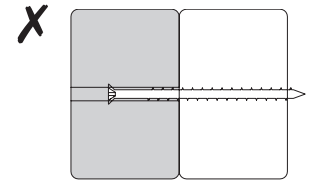
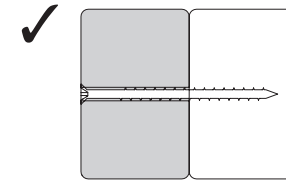
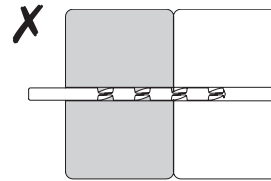
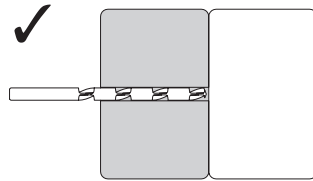
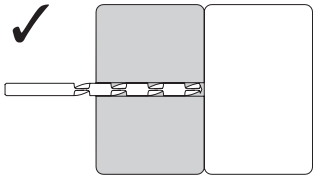
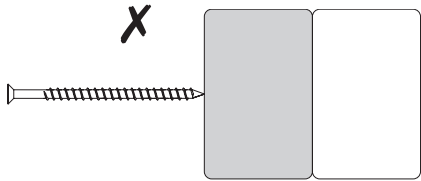

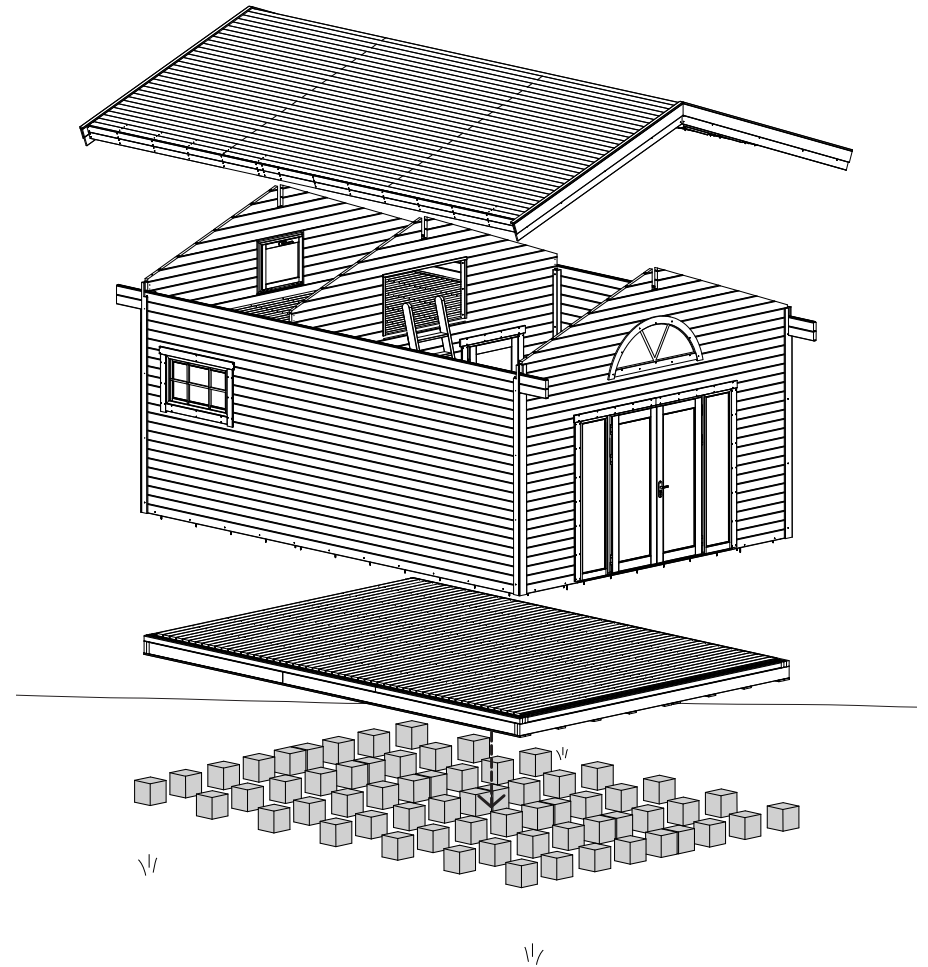
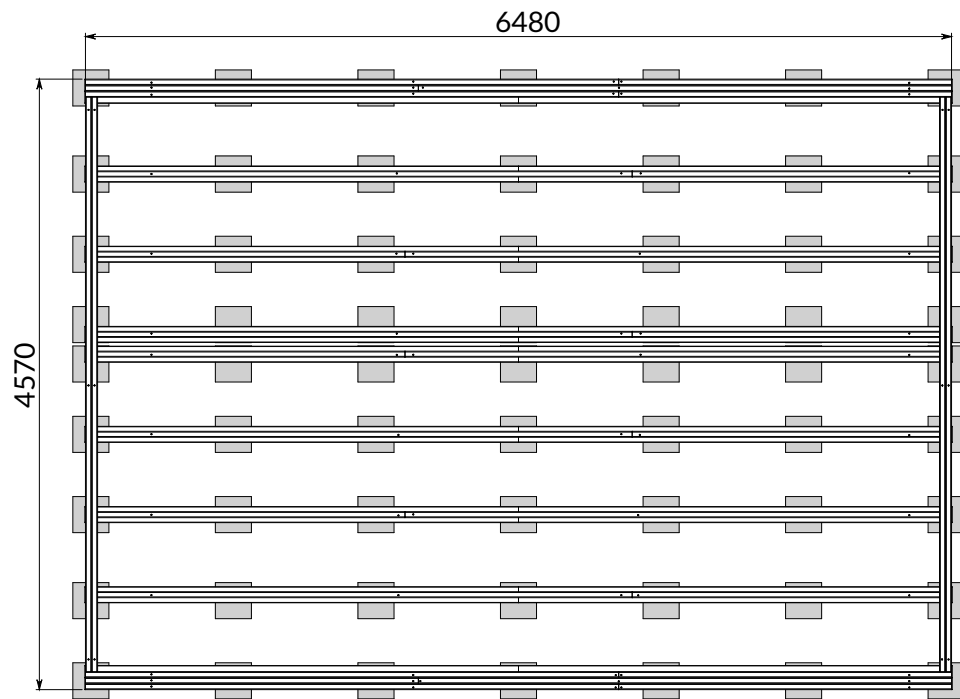

# V-1

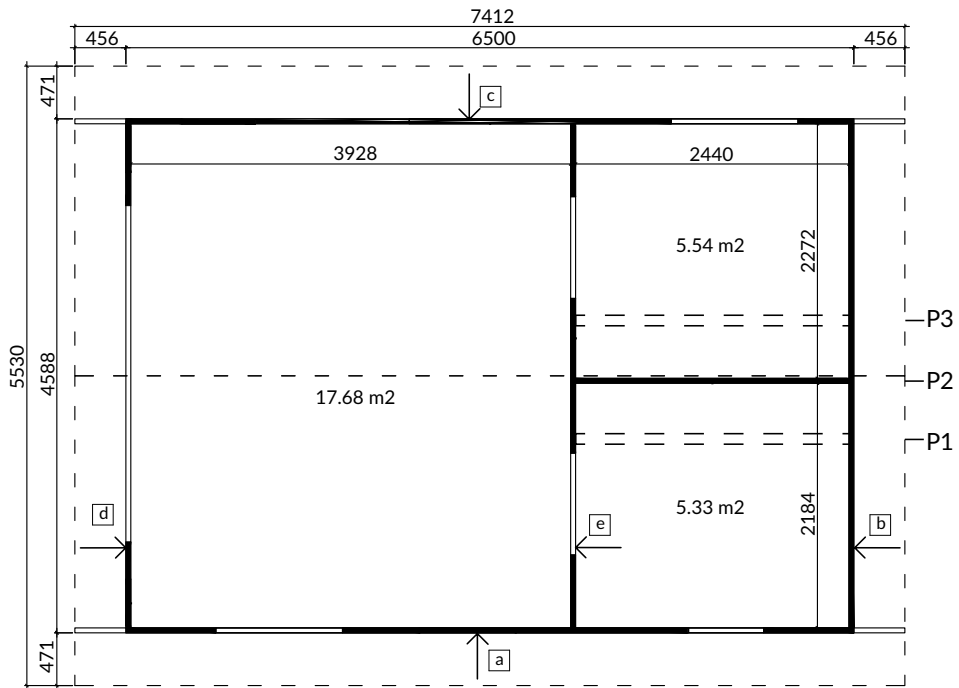

# V-2

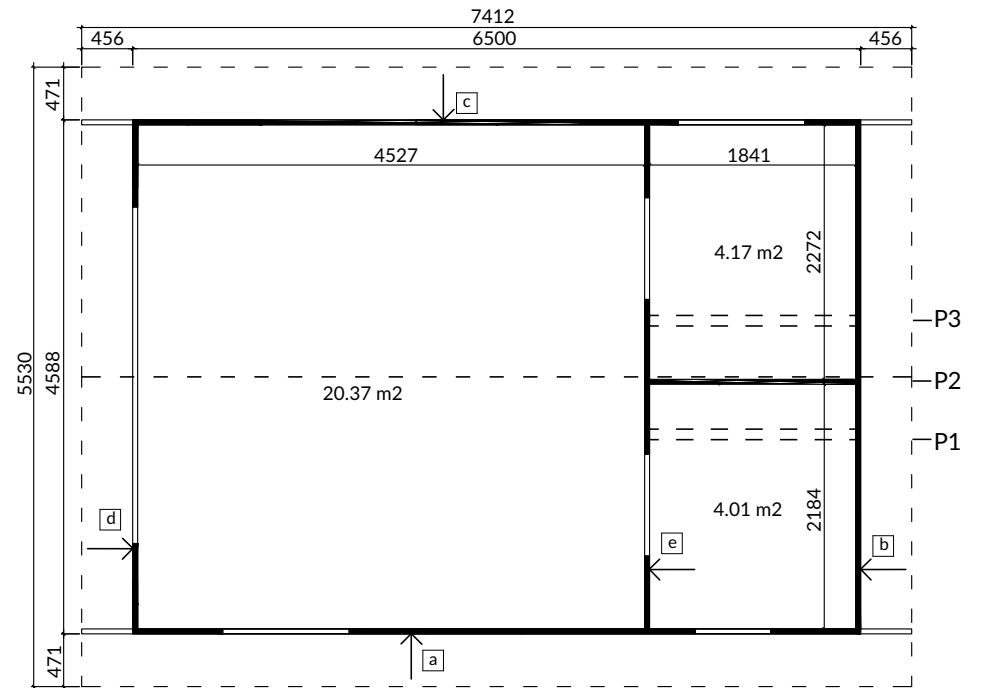

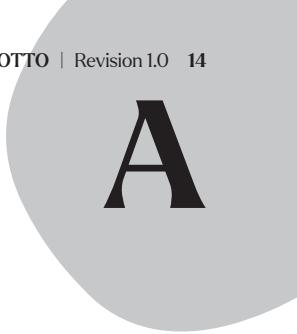

# A

W1  
x14  
□ (120x18) x 3240mm (IAR2)

W2  
x8  
□ (90x18) x 3240mm (IAR1)

W3  
x13  
□ (146x44) x 4000mm (AR4)

W4  
x13  
□ (146x44) x 2304mm (AR6)

W5  
x4  
□ (146x44) x 4568mm (AR1)

W6  
x4  
□ (70x45) x 4298mm (AR2)

W7  
x13  
□ (70x45) x 4000mm (AR5)

W8  
x6  
□ (70x45) x 2480mm (AR3)

W9  
x7  
□ (70x45) x 2300mm (AR7)



90mm



60mm



120mm

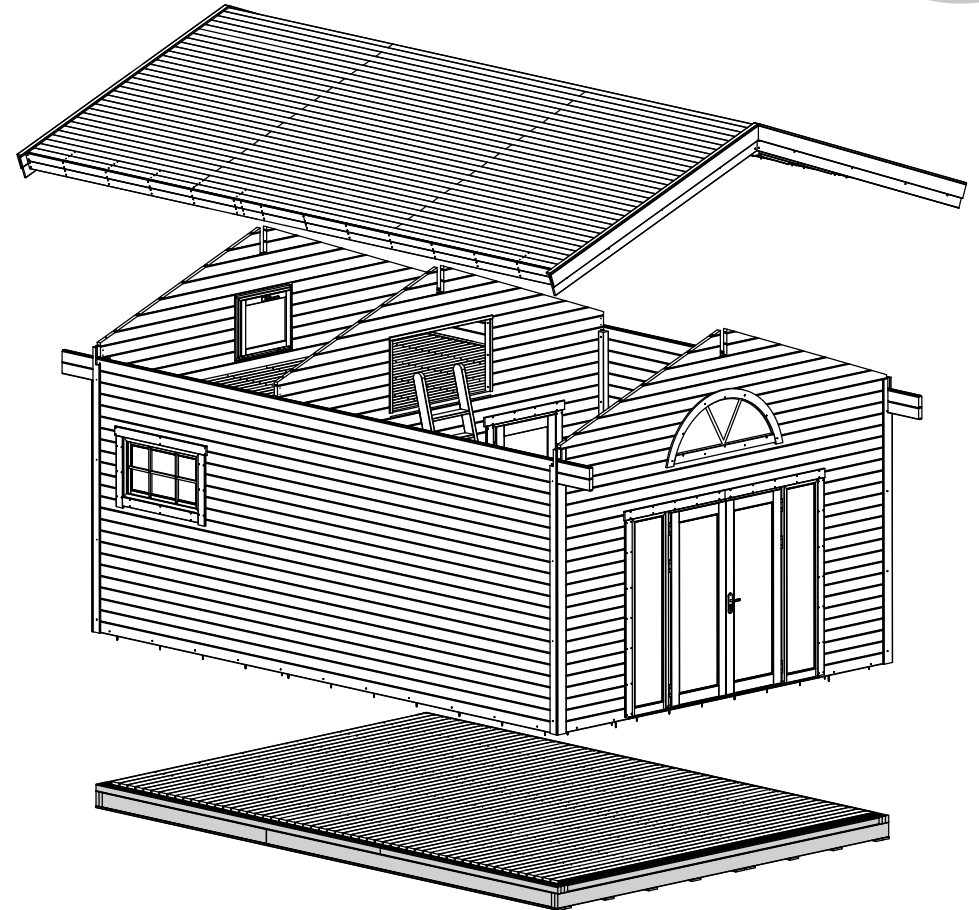

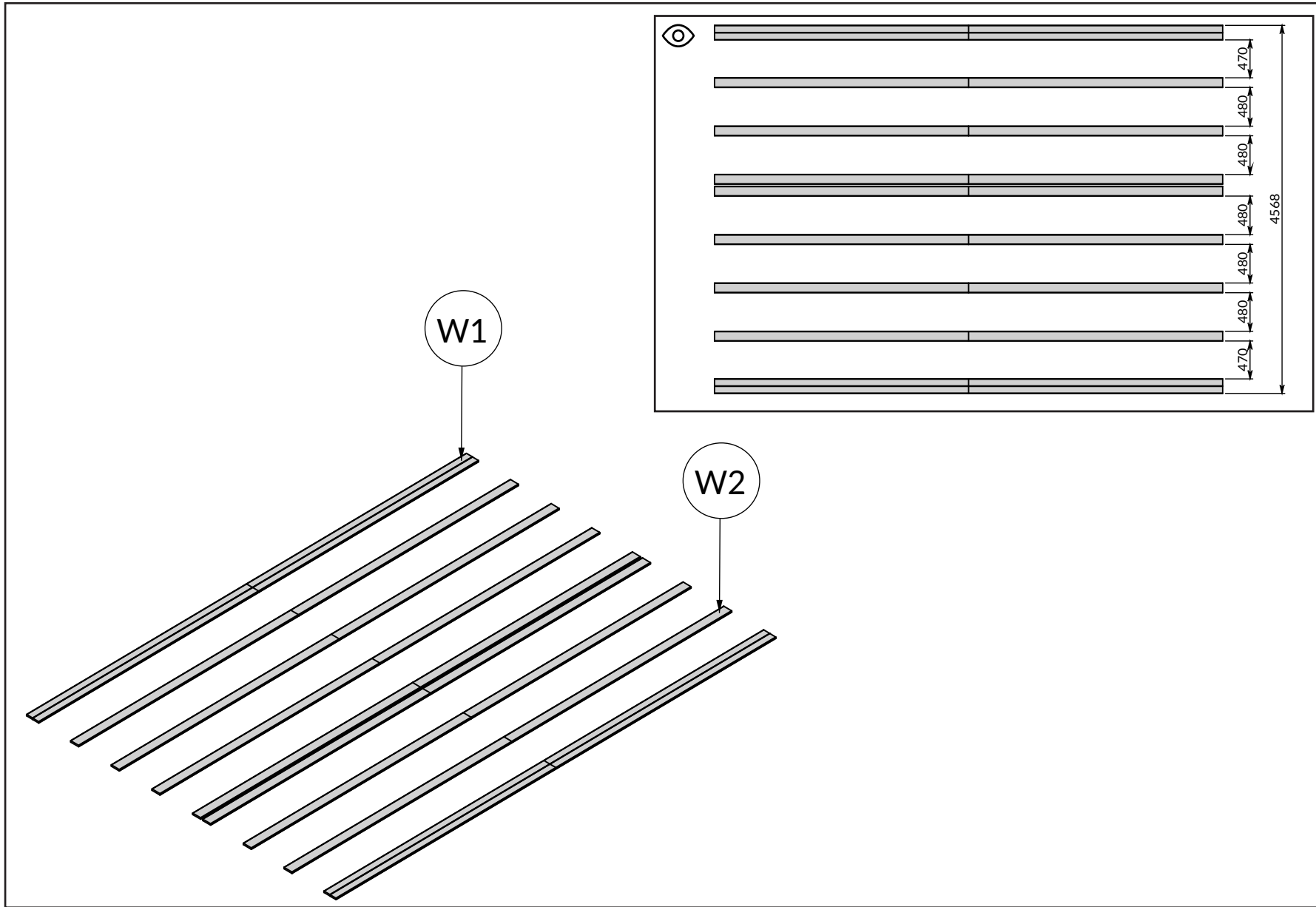

W1 x8

W2 x14

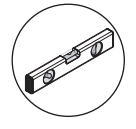
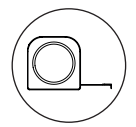

A|1→2→3→4→5→ B|1→2→3→4→5→6→7→8→9→10→11→12→13→14→15→16→17→18→19→20→  
 C|1→2→3→4→5→6→7→8→9→ D|1→2→3→4→5→6→7→8→ E|1→2→3→4→5→6→7→  
 F|1→2→3→4→5→ G|1→2→3→ H|1→2→3→ I|1→2→3→4→5→ J|1→2→3→4→

# A1

A|1→2→3→4→5→ B|1→2→3→4→5→6→7→8→9→10→11→12→13→14→15→16→17→18→19→20→  
C|1→2→3→4→5→6→7→8→9→ D|1→2→3→4→5→6→7→8→ E|1→2→3→4→5→6→7→  
F|1→2→3→4→5→ G|1→2→3→ H|1→2→3→ I|1→2→3→4→5→ J|1→2→3→4→

# A2

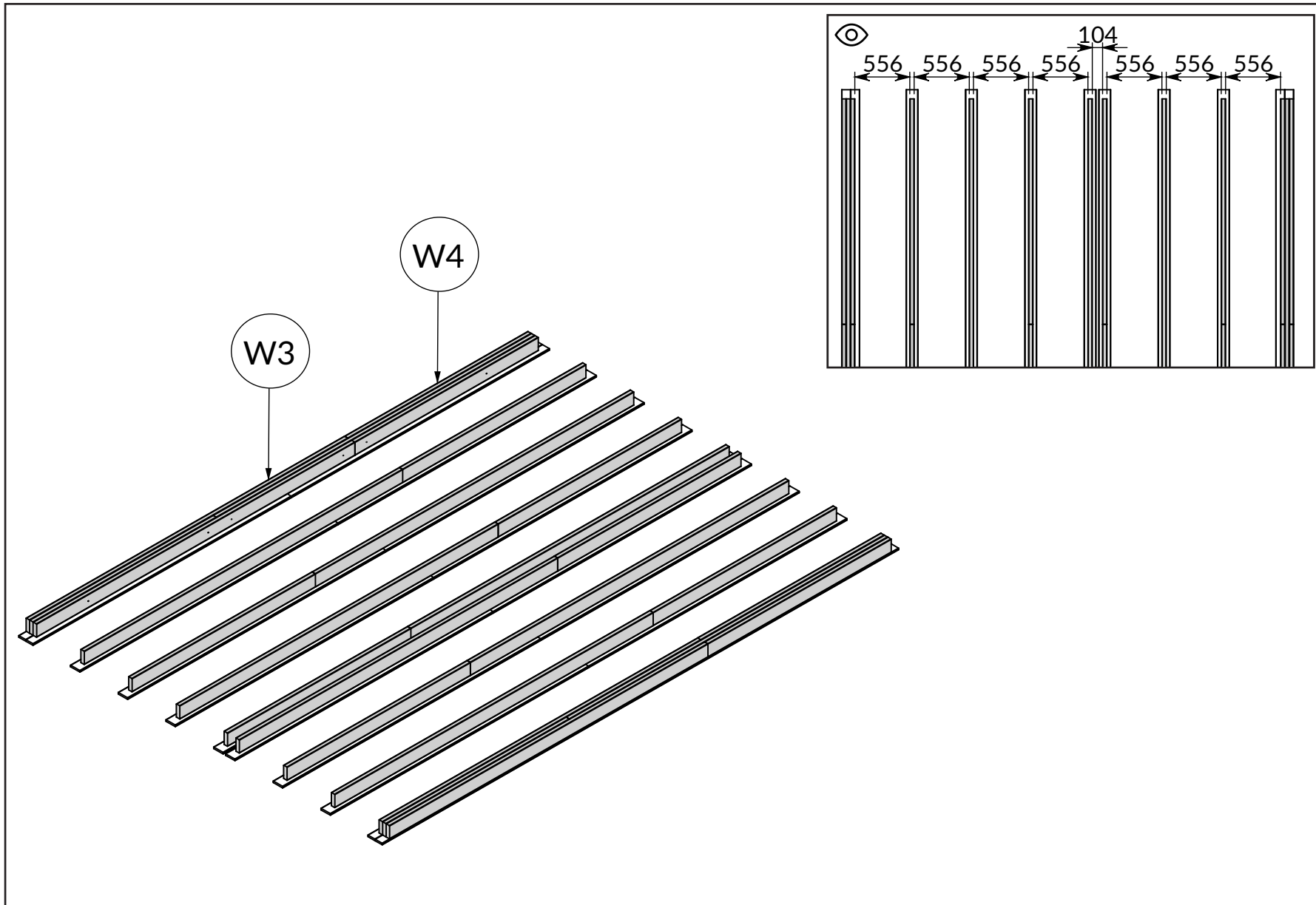

W3 x13

W4 x13

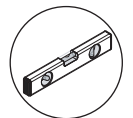

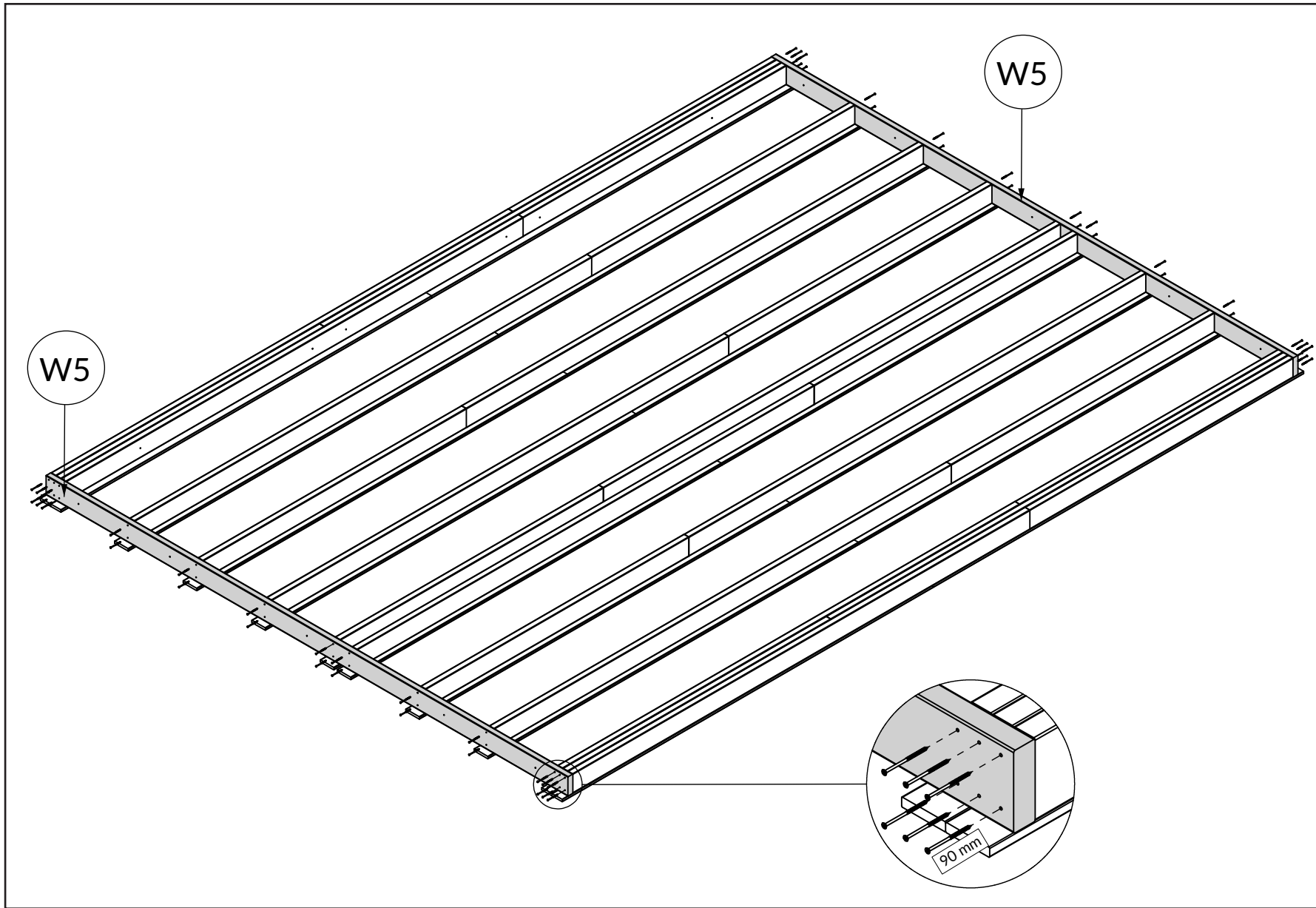

W5 x2

A|1→2→3→4→5→ B|1→2→3→4→5→6→7→8→9→10→11→12→13→14→15→16→17→18→19→20→  
 C|1→2→3→4→5→6→7→8→9→ D|1→2→3→4→5→6→7→8→ E|1→2→3→4→5→6→7→  
 F|1→2→3→4→5→ G|1→2→3→ H|1→2→3→ I|1→2→3→4→5→ J|1→2→3→4→

# A3

A|1→2→3→4→5→ B|1→2→3→4→5→6→7→8→9→10→11→12→13→14→15→16→17→18→19→20→  
C|1→2→3→4→5→6→7→8→9→ D|1→2→3→4→5→6→7→8→ E|1→2→3→4→5→6→7→  
F|1→2→3→4→5→ G|1→2→3→ H|1→2→3→ I|1→2→3→4→5→ J|1→2→3→4→

# A4

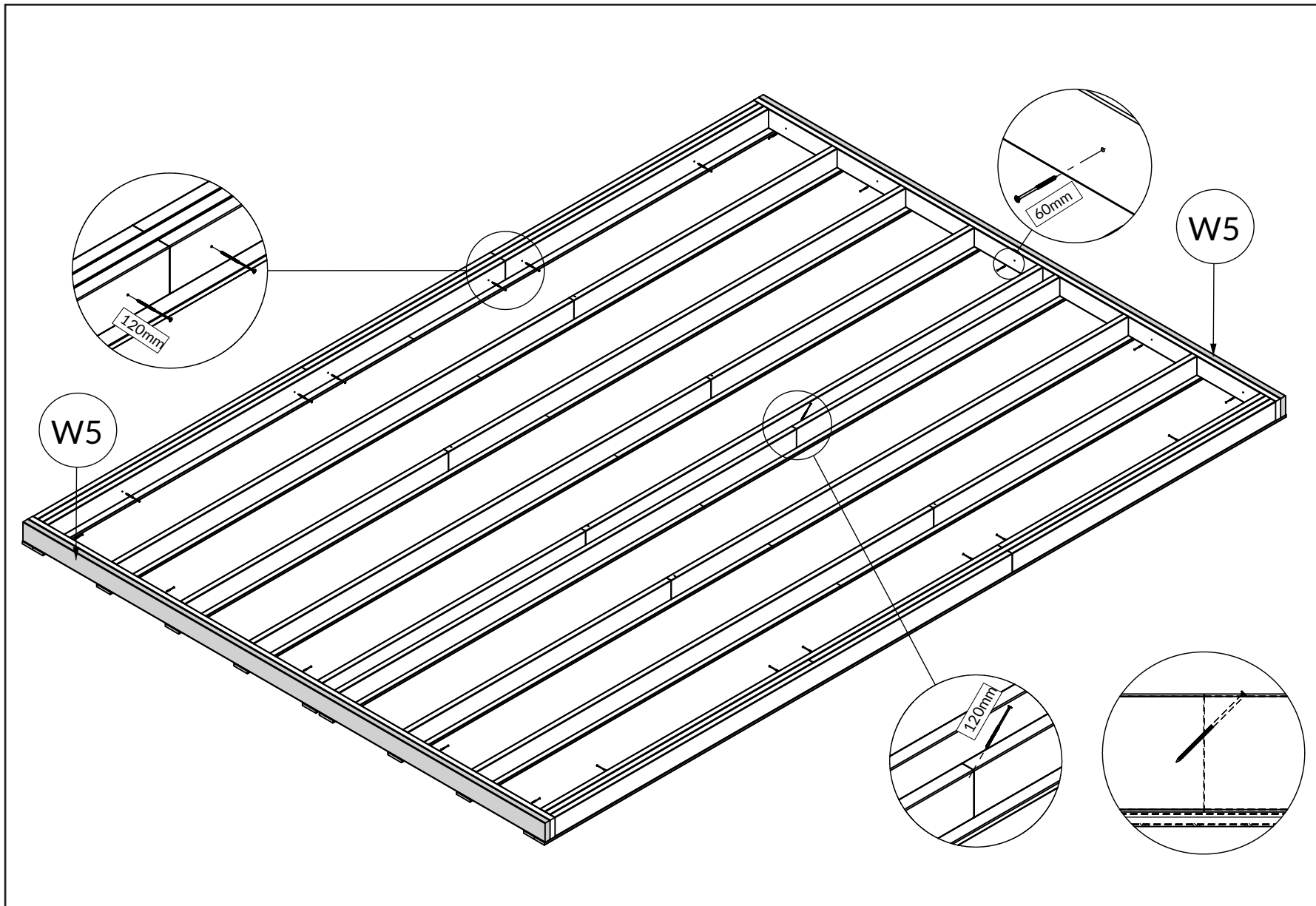

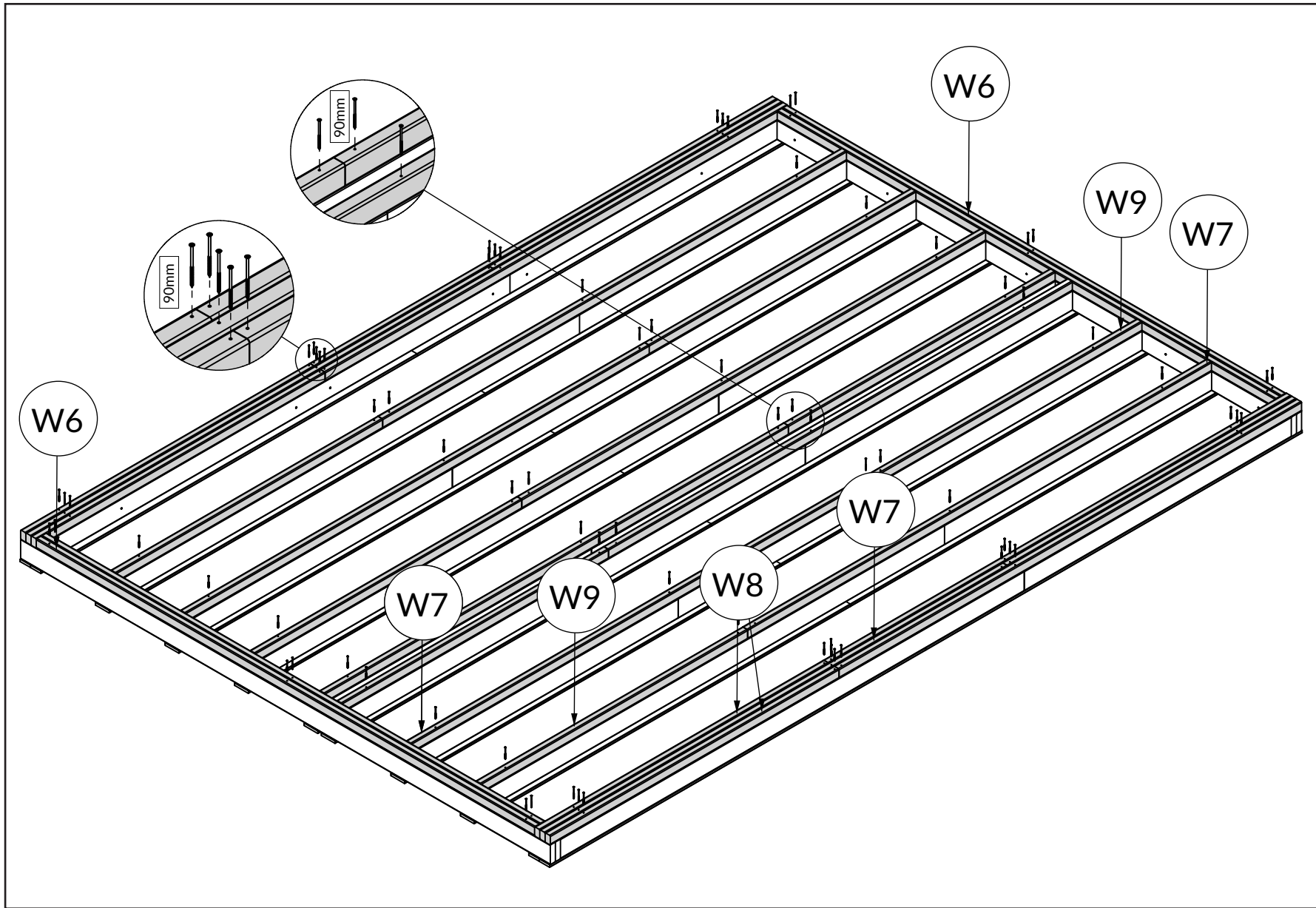

- W6 x4
- W7 x13
- W8 x6
- W9 x7

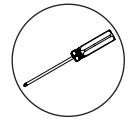
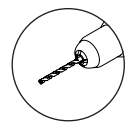























**A**|1→2→3→4→5→    **B**|1→2→3→4→5→6→7→8→9→10→11→12→13→14→15→16→17→18→19→20→  
**C**|1→2→3→4→5→6→7→8→9→    **D**|1→2→3→4→5→6→7→8→    **E**|1→2→3→4→5→6→7→  
**F**|1→2→3→4→5→    **G**|1→2→3→    **H**|1→2→3→    **I**|1→2→3→4→5→    **J**|1→2→3→4→

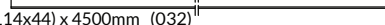

# A5

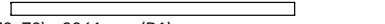



# B

## B

- W10   $\times 4$   
(70x70) x 4360mm (PT1)
- W11   $\times 4$   
(70x70) x 3136mm (PT2)
- W12   $\times 33$   
(114x44) x 6500mm (001)
- W13   $\times 12$   
(114x44) x 500mm (002)
- W14   $\times 6$   
(114x44) x 3395mm (003)
- W15   $\times 6$   
(114x44) x 805mm (004)
- W16   $\times 4$   
(114x44) x 7412mm (005)
- W17   $\times 36$   
(114x44) x 935mm (012)
- W18   $\times 6$   
(114x44) x 4870mm (008)
- W19   $\times 27$   
(114x44) x 4500mm (013)
- W20   $\times 2$   
(114x44) x 1578mm (014)
- W21   $\times 2$   
(114x44) x 1646mm (015)
- W22   $\times 2$   
(114x44) x 1745mm (016)
- W23   $\times 8$   
(114x44) x 1853mm (025)

- W24   $\times 2$   
(86x44) x 650mm (028)
- W25   $\times 1$   
(86x44) x 1380mm (029)
- W26   $\times 1$   
(114x44) x 4500mm (032)
- W27   $\times 8$   
(114x44) x 1560mm (033)
- W28   $\times 1$   
(70x70) x 2061mm (P1)
- W29   $\times 8$   
(70x70) x 2700mm (P2)
- W30   $\times 34$   
(114x44) x 650mm (030)
- W31   $\times 17$   
(114x44) x 1380mm (031)
- W32   $\times 1$   
(112x28) x 4360mm (HLL-1)

- W33 (WA-1)   $\times 1$
- W34 (WC-1)   $\times 1$
- W35 (WB-1)   $\times 1$

-  90mm
-  60mm
-  180mm
-  120mm
-  40mm

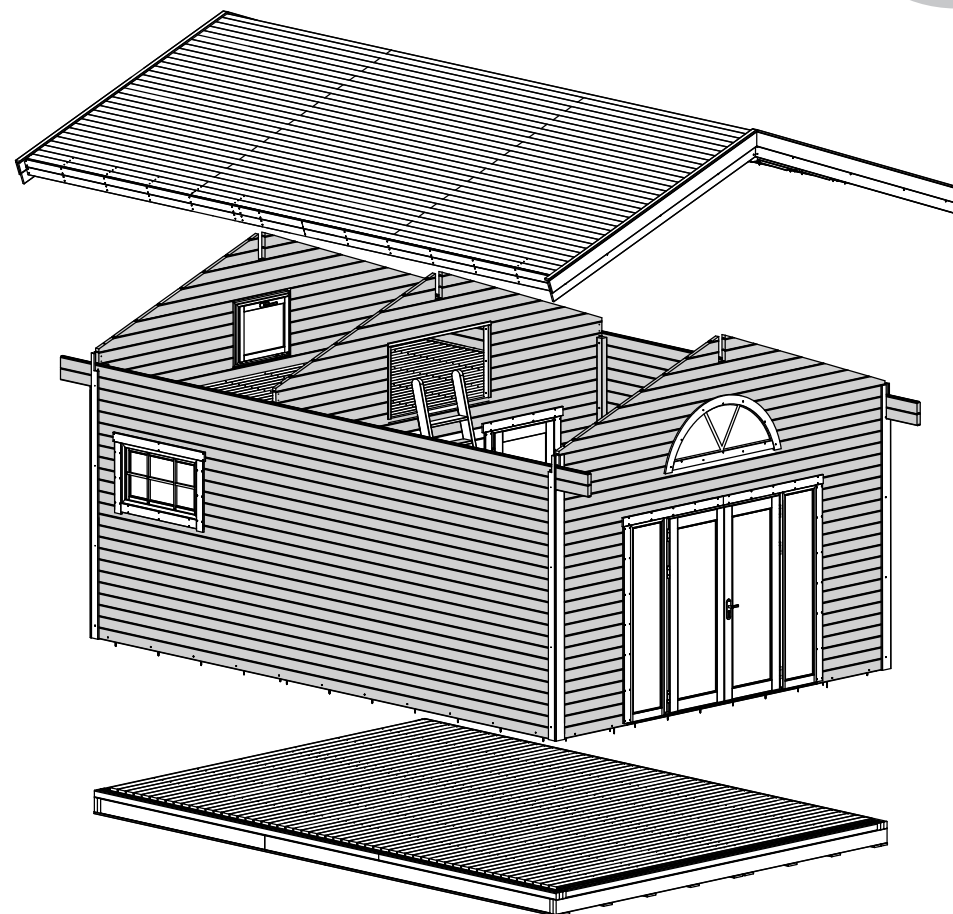



V-1

a	W11		x1	W11.1	
	W10		x1	W10.1	
b	P1		x1	W10.2	W10.3
	P2		x1	W10.5	W10.6
	P3		x1	W10.7	W10.8
c	W10		x1	W10.9	
	W11		x1	W11.2	
d	W11		x1	W11.3	W11.4

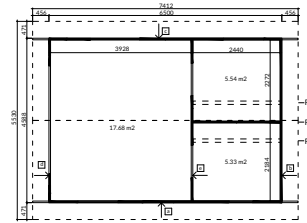

V-1



A|1→2→3→4→5→ B|1→2→3→4→5→6→7→8→9→10→11→12→13→14→15→16→17→18→19→20→  
 C|1→2→3→4→5→6→7→8→9→ D|1→2→3→4→5→6→7→8→ E|1→2→3→4→5→6→7→  
 F|1→2→3→4→5→ G|1→2→3→ H|1→2→3→ I|1→2→3→4→5→ J|1→2→3→4→

# B1

# B2

A|1→2→3→4→5→ B|1→2→3→4→5→6→7→8→9→10→11→12→13→14→15→16→17→18→19→20→  
 C|1→2→3→4→5→6→7→8→9→ D|1→2→3→4→5→6→7→8→ E|1→2→3→4→5→6→7→  
 F|1→2→3→4→5→ G|1→2→3→ H|1→2→3→ I|1→2→3→4→5→ J|1→2→3→4→



V-2

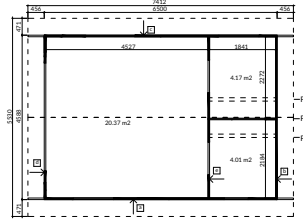

V-2



a	W11		x1	W11.5
	W10		x1	W10.10
b	P1		x1	W10.1 W10.2
	P2		x1	W10.3 W10.4
	P3		x1	W10.5 W10.6
c	W10		x1	W10.11
	W11		x1	W11.6
d	W11		x1	W11.7 W11.8

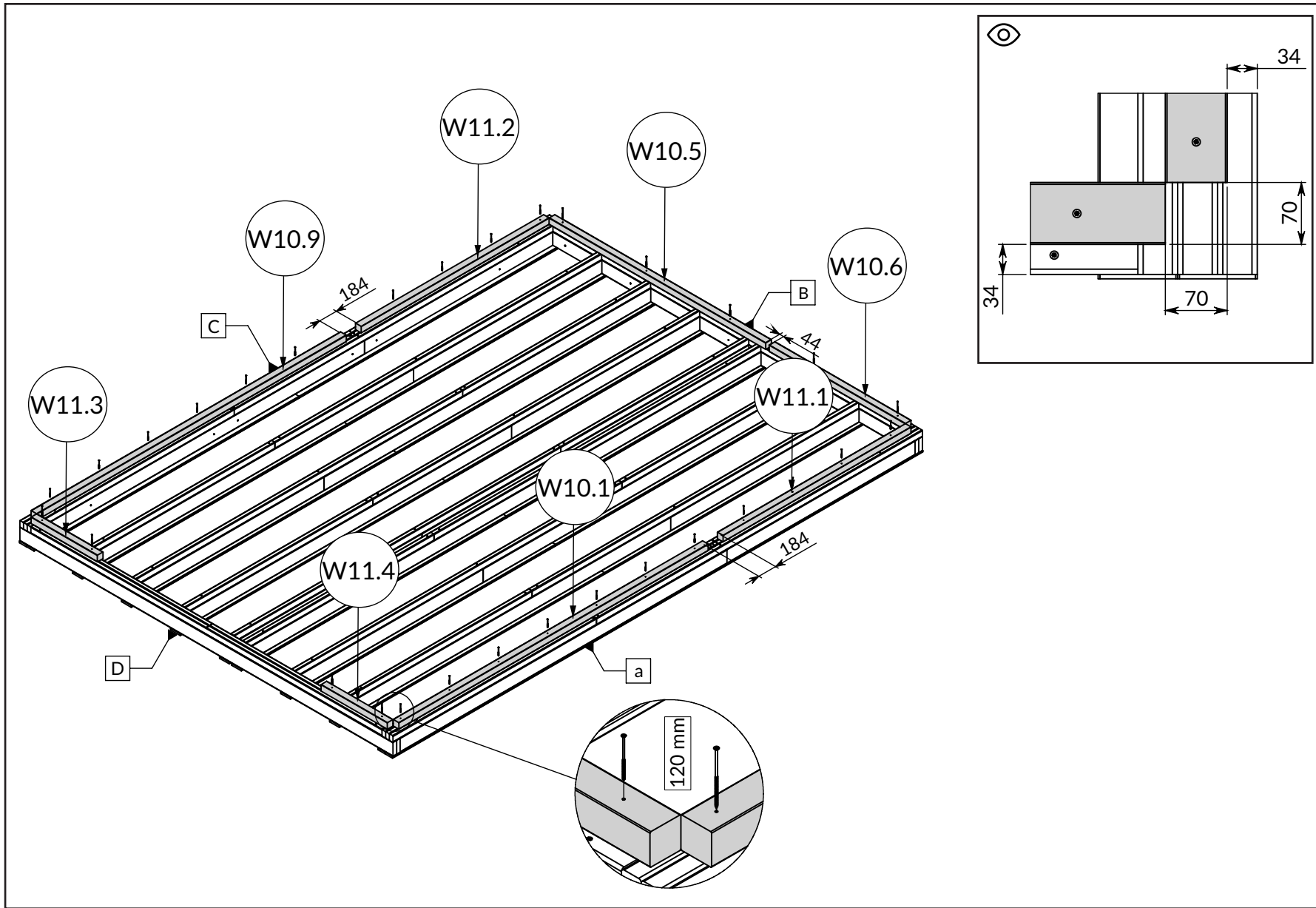

- W10.1 x1
- W10.5 x1
- W10.6 x1
- W10.9 x1
- W11.1 x1
- W11.2 x1
- W11.3 x1
- W11.4 x1

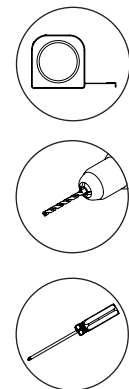

A|1→2→3→4→5→ B|1→2→3→4→5→6→7→8→9→10→11→12→13→14→15→16→17→18→19→20→  
 C|1→2→3→4→5→6→7→8→9→ D|1→2→3→4→5→6→7→8→ E|1→2→3→4→5→6→7→  
 F|1→2→3→4→5→ G|1→2→3→ H|1→2→3→ I|1→2→3→4→5→ J|1→2→3→4→

# B3

A|1→2→3→4→5→ B|1→2→3→4→5→6→7→8→9→10→11→12→13→14→15→16→17→18→19→20→  
C|1→2→3→4→5→6→7→8→9→ D|1→2→3→4→5→6→7→8→ E|1→2→3→4→5→6→7→  
F|1→2→3→4→5→ G|1→2→3→ H|1→2→3→ I|1→2→3→4→5→ J|1→2→3→4→

# B4

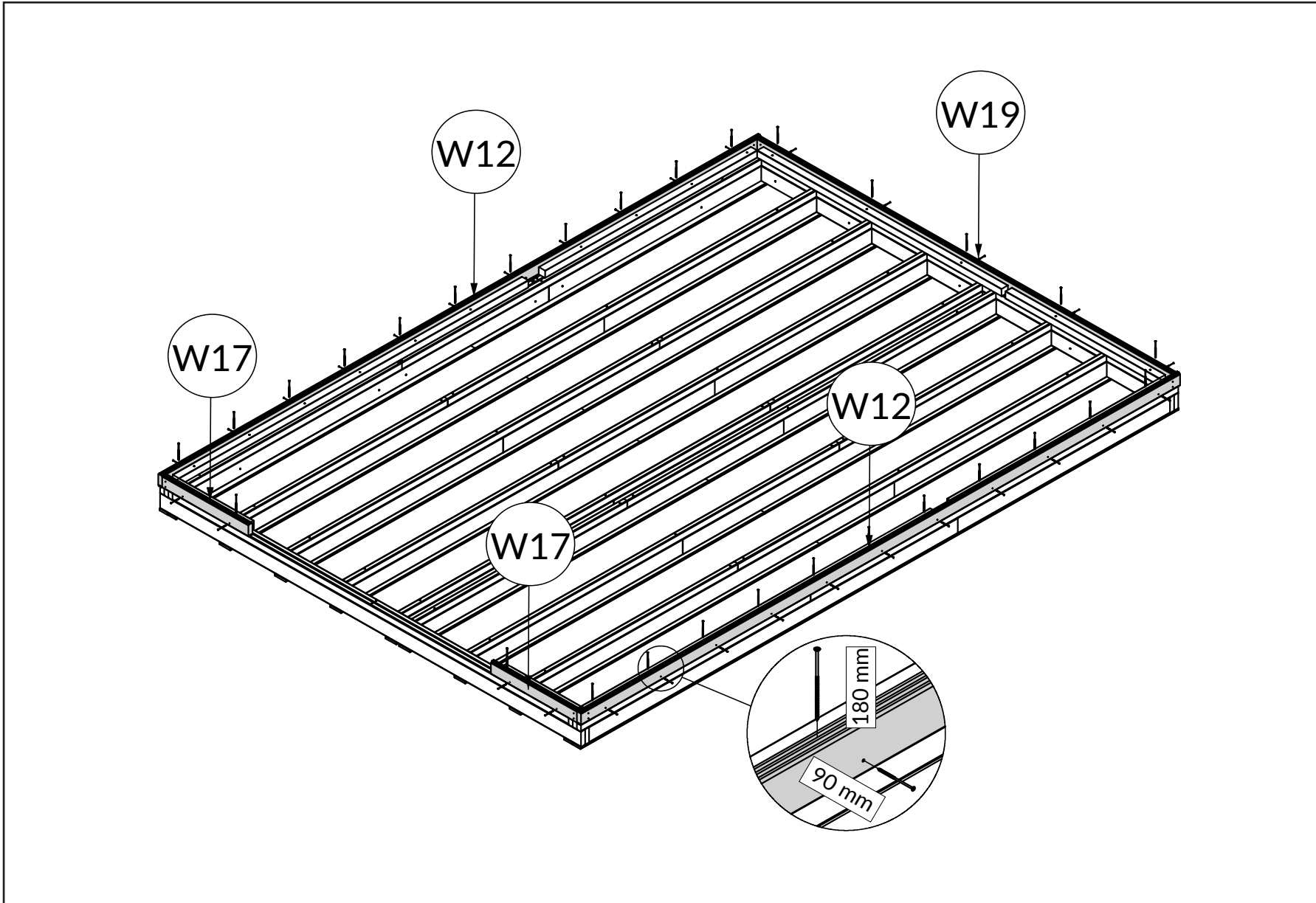

W12 x2

W17 x2

W19 x1

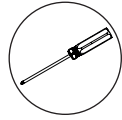
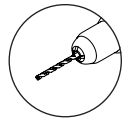
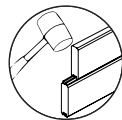
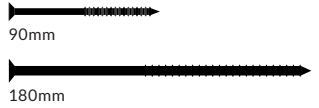

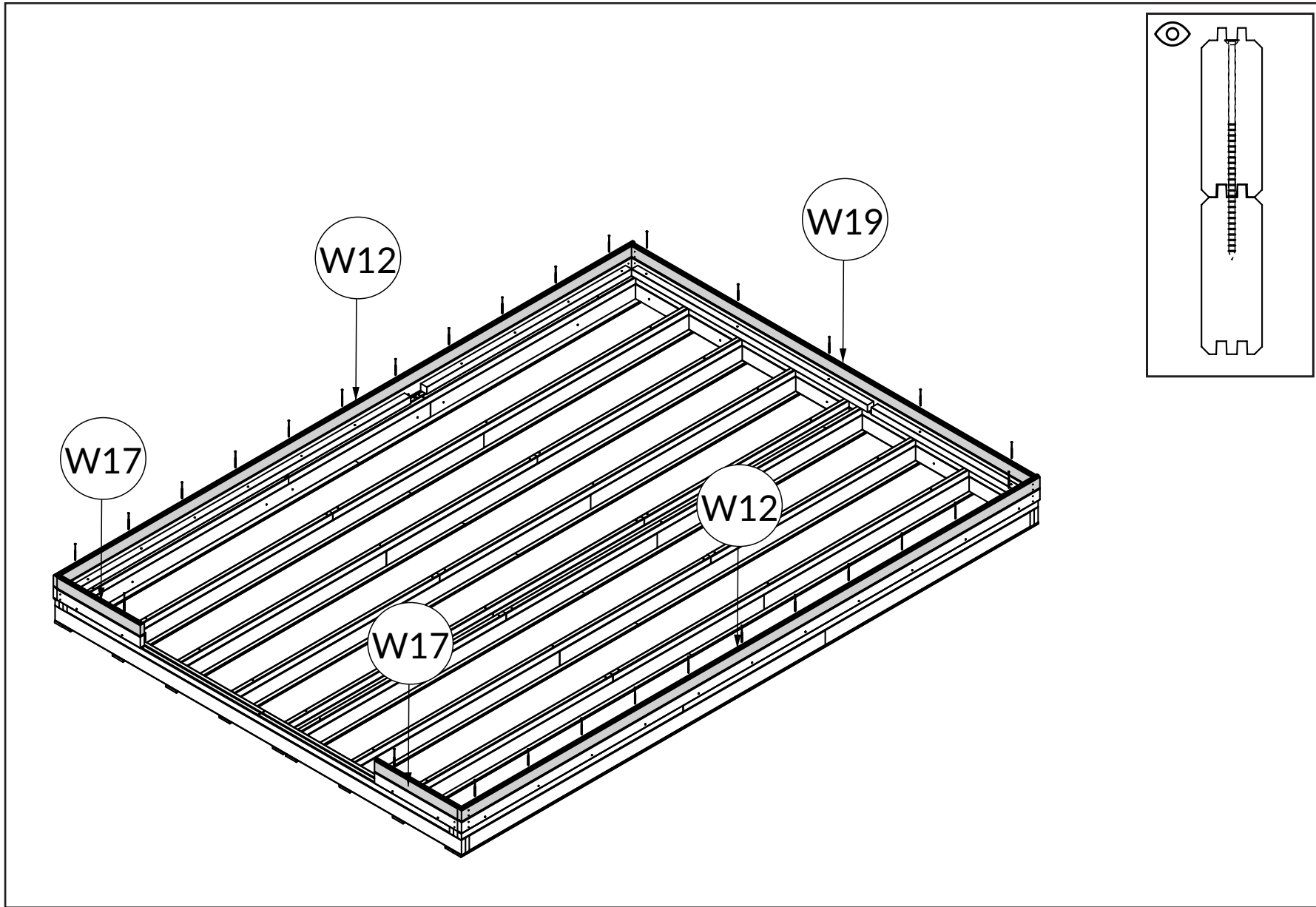

- W12 x2
- W17 x2
- W19 x1

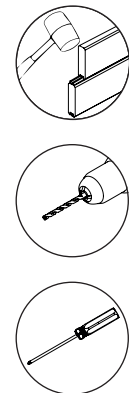

A|1→2→3→4→5→    B|1→2→3→4→5→6→7→8→9→10→11→12→13→14→15→16→17→18→19→20→  
 C|1→2→3→4→5→6→7→8→9→    D|1→2→3→4→5→6→7→8→    E|1→2→3→4→5→6→7→  
 F|1→2→3→4→5→    G|1→2→3→    H|1→2→3→    I|1→2→3→4→5→    J|1→2→3→4→

# B5

A|1→2→3→4→5→ B|1→2→3→4→5→6→7→8→9→10→11→12→13→14→15→16→17→18→19→20→  
C|1→2→3→4→5→6→7→8→9→ D|1→2→3→4→5→6→7→8→ E|1→2→3→4→5→6→7→  
F|1→2→3→4→5→ G|1→2→3→ H|1→2→3→ I|1→2→3→4→5→ J|1→2→3→4→

# B6

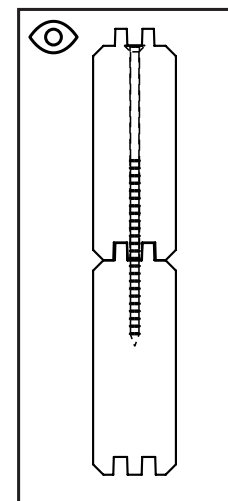
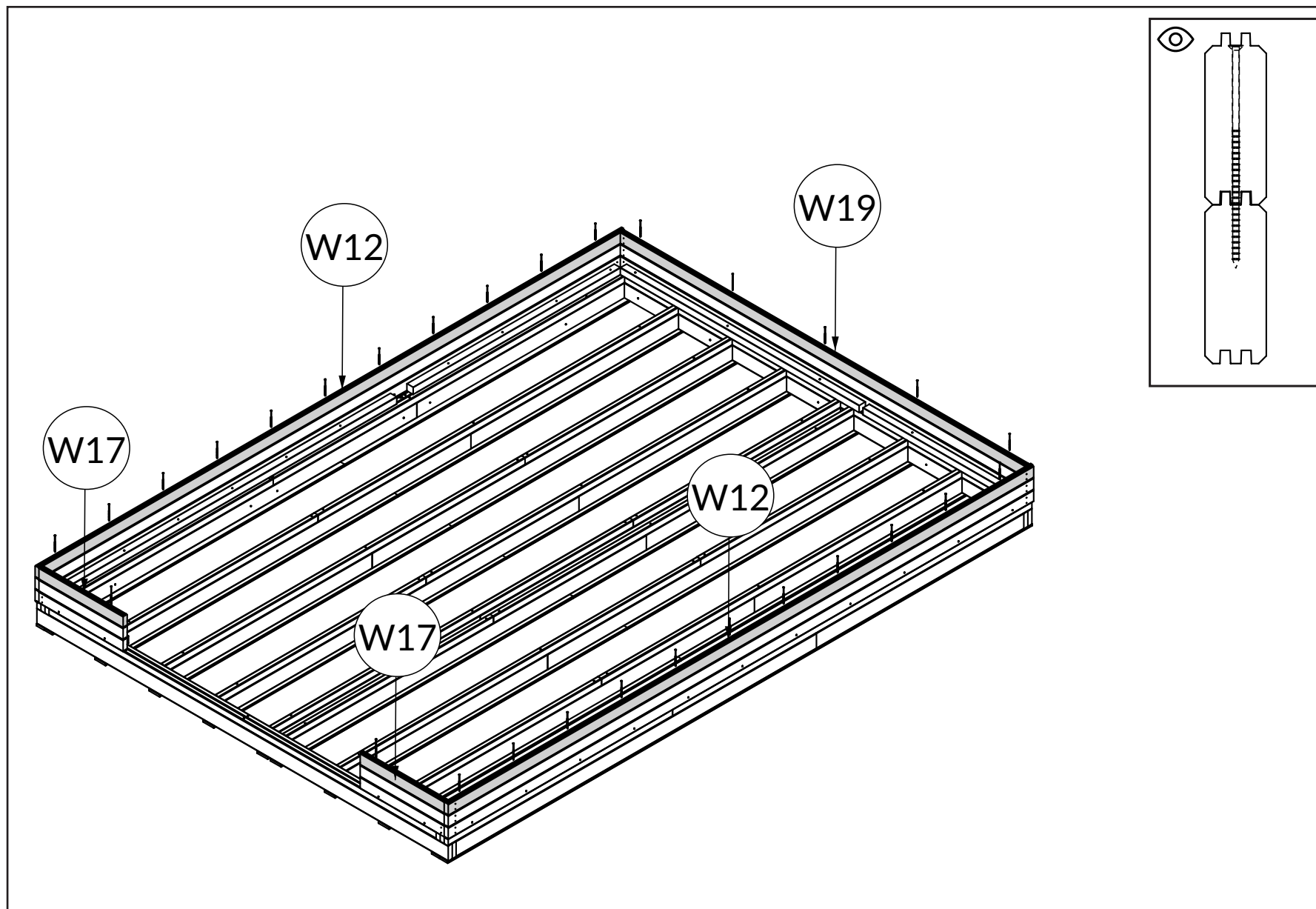

W12 x2

W17 x2

W19 x1

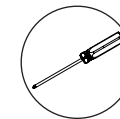
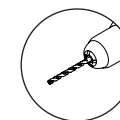
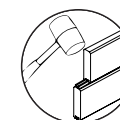
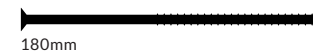

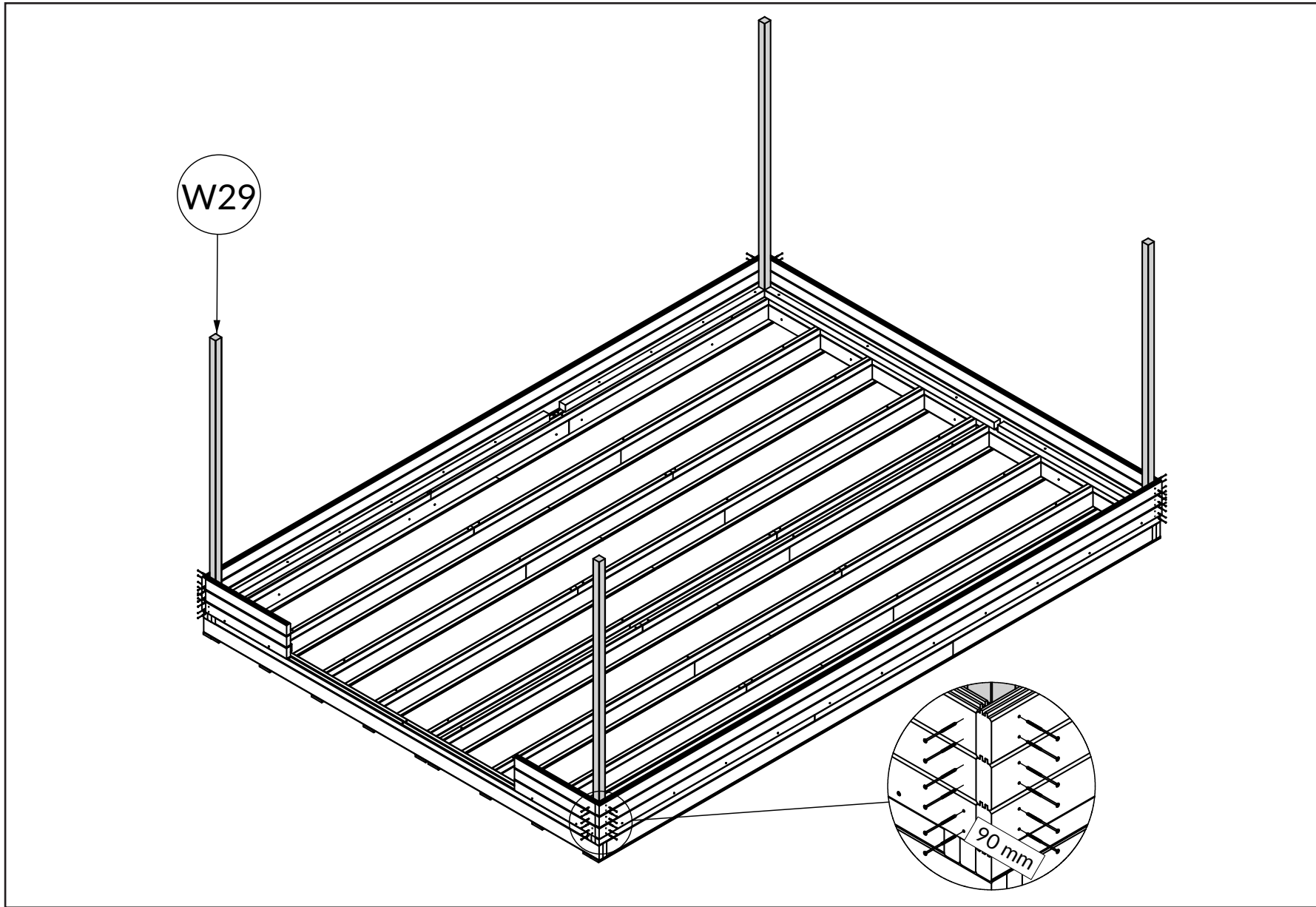

W29 x4

W29

90mm

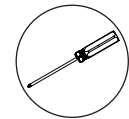
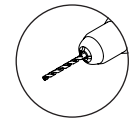
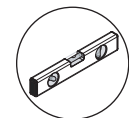

A|1→2→3→4→5→ B|1→2→3→4→5→6→7→8→9→10→11→12→13→14→15→16→17→18→19→20→  
 C|1→2→3→4→5→6→7→8→9→ D|1→2→3→4→5→6→7→8→ E|1→2→3→4→5→6→7→  
 F|1→2→3→4→5→ G|1→2→3→ H|1→2→3→ I|1→2→3→4→5→ J|1→2→3→4→

# B7

A|1→2→3→4→5→ B|1→2→3→4→5→6→7→8→9→10→11→12→13→14→15→16→17→18→19→20→  
C|1→2→3→4→5→6→7→8→9→ D|1→2→3→4→5→6→7→8→ E|1→2→3→4→5→6→7→  
F|1→2→3→4→5→ G|1→2→3→ H|1→2→3→ I|1→2→3→4→5→ J|1→2→3→4→

# B8

W29 x2

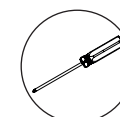
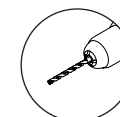
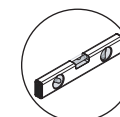
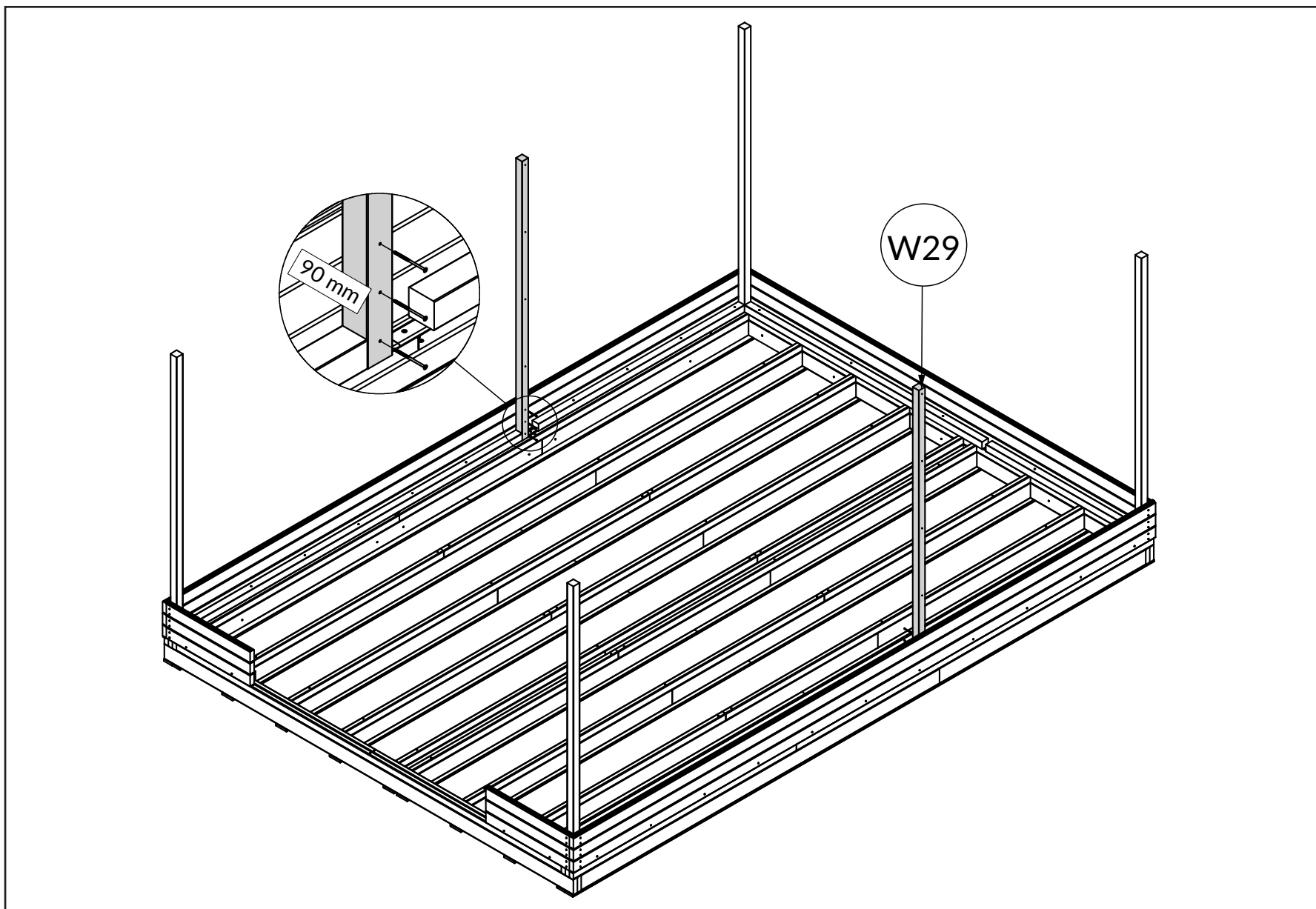

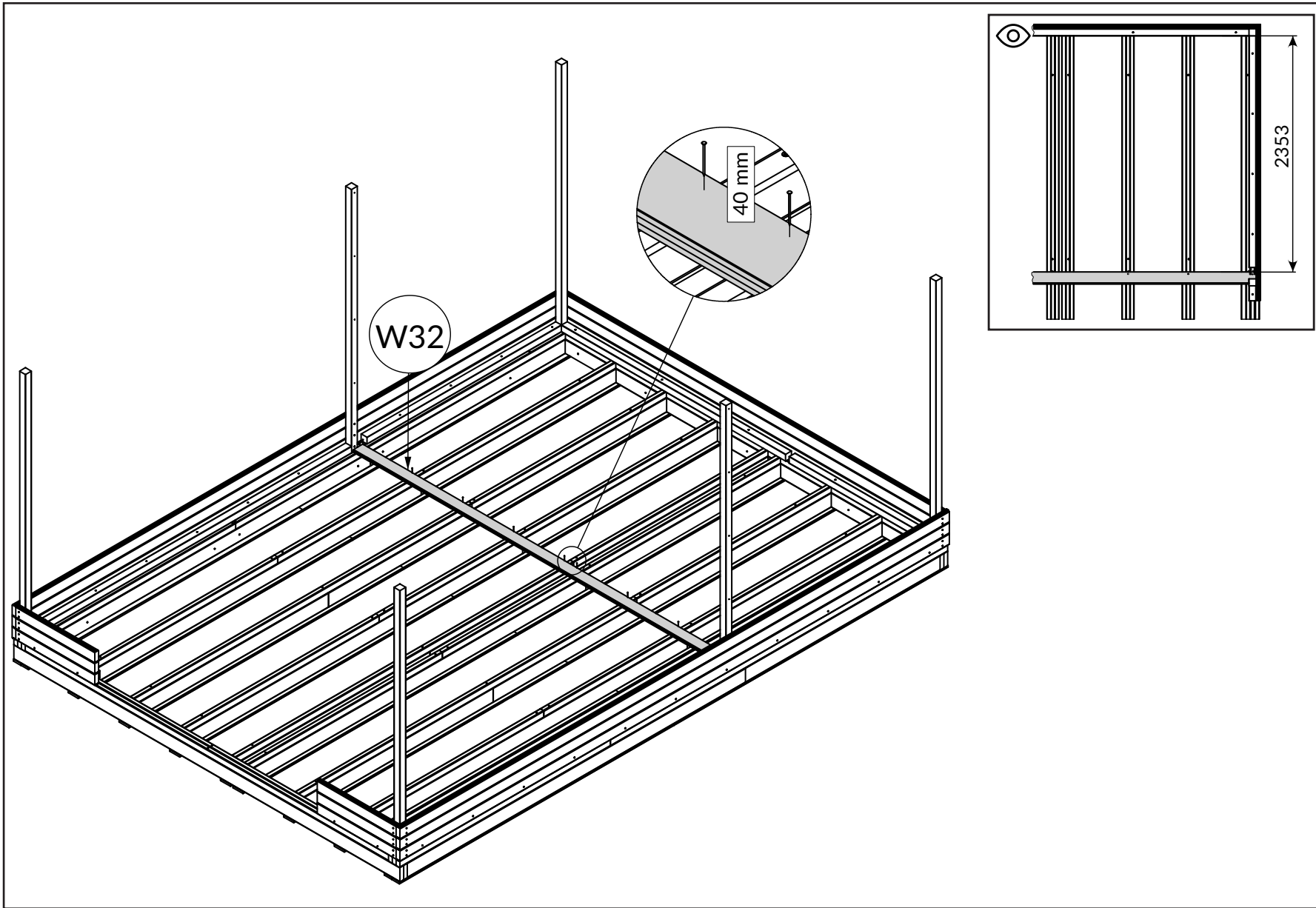

W32 x1

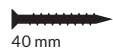
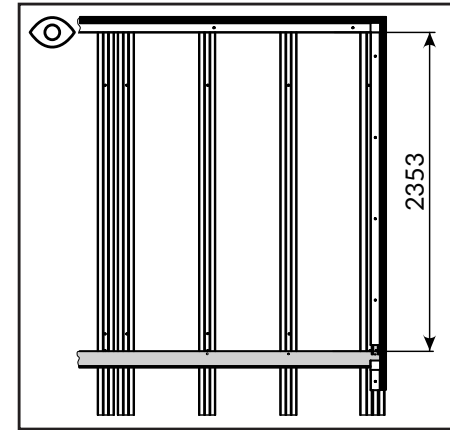
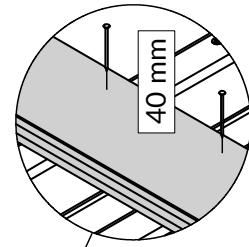

40 mm



A|1→2→3→4→5→    B|1→2→3→4→5→6→7→8→9→10→11→12→13→14→15→16→17→18→19→20→  
 C|1→2→3→4→5→6→7→8→9→    D|1→2→3→4→5→6→7→8→    E|1→2→3→4→5→6→7→  
 F|1→2→3→4→5→    G|1→2→3→    H|1→2→3→    I|1→2→3→4→5→    J|1→2→3→4→

# B9

A|1→2→3→4→5→    B|1→2→3→4→5→6→7→8→9→10→11→12→13→14→15→16→17→18→19→20→  
C|1→2→3→4→5→6→7→8→9→    D|1→2→3→4→5→6→7→8→    E|1→2→3→4→5→6→7→  
F|1→2→3→4→5→    G|1→2→3→    H|1→2→3→    I|1→2→3→4→5→    J|1→2→3→4→

# B10

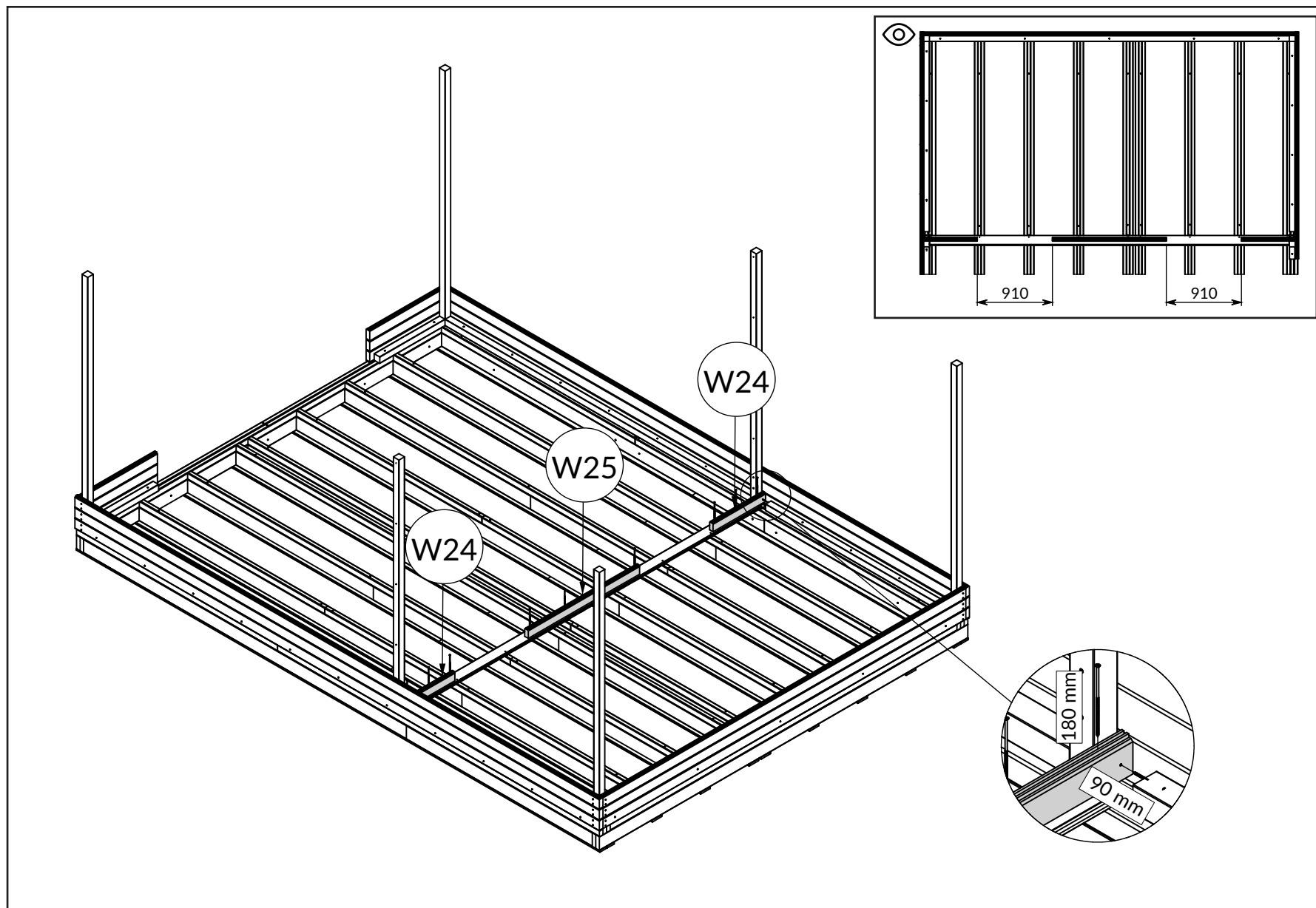

W24 x2

W25 x1

90mm

180mm

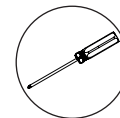
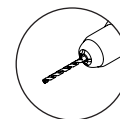

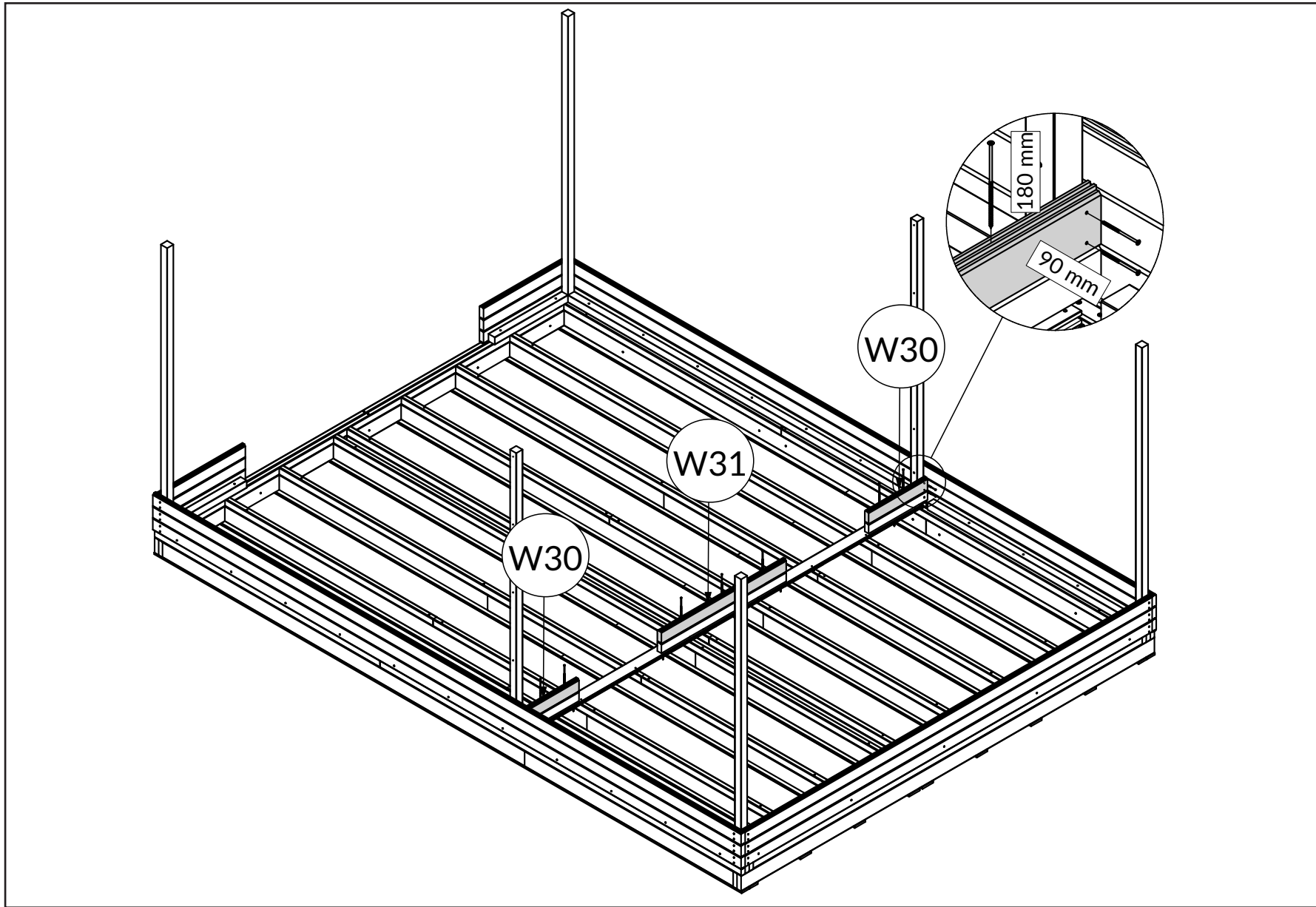

W30 x2

W31 x1

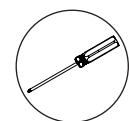
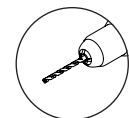

A|1→2→3→4→5→    B|1→2→3→4→5→6→7→8→9→10→11→12→13→14→15→16→17→18→19→20→  
 C|1→2→3→4→5→6→7→8→9→    D|1→2→3→4→5→6→7→8→    E|1→2→3→4→5→6→7→  
 F|1→2→3→4→5→    G|1→2→3→    H|1→2→3→    I|1→2→3→4→5→    J|1→2→3→4→

# B11

A|1→2→3→4→5→    B|1→2→3→4→5→6→7→8→9→10→11→12→13→14→15→16→17→18→19→20→  
C|1→2→3→4→5→6→7→8→9→    D|1→2→3→4→5→6→7→8→    E|1→2→3→4→5→6→7→  
F|1→2→3→4→5→    G|1→2→3→    H|1→2→3→    I|1→2→3→4→5→    J|1→2→3→4→

# B12

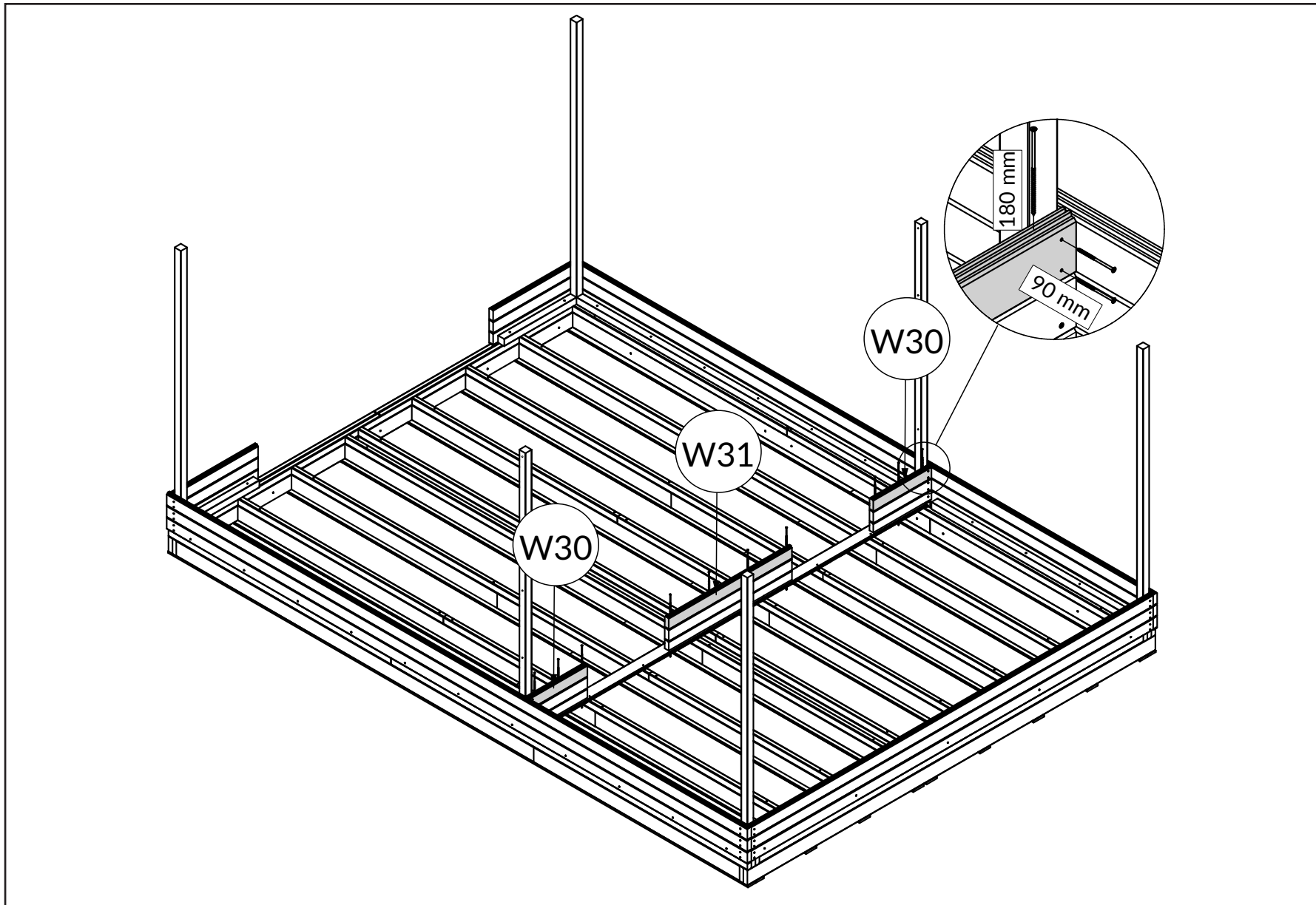

W30 x2

W31 x1

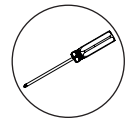
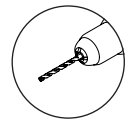
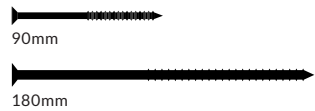

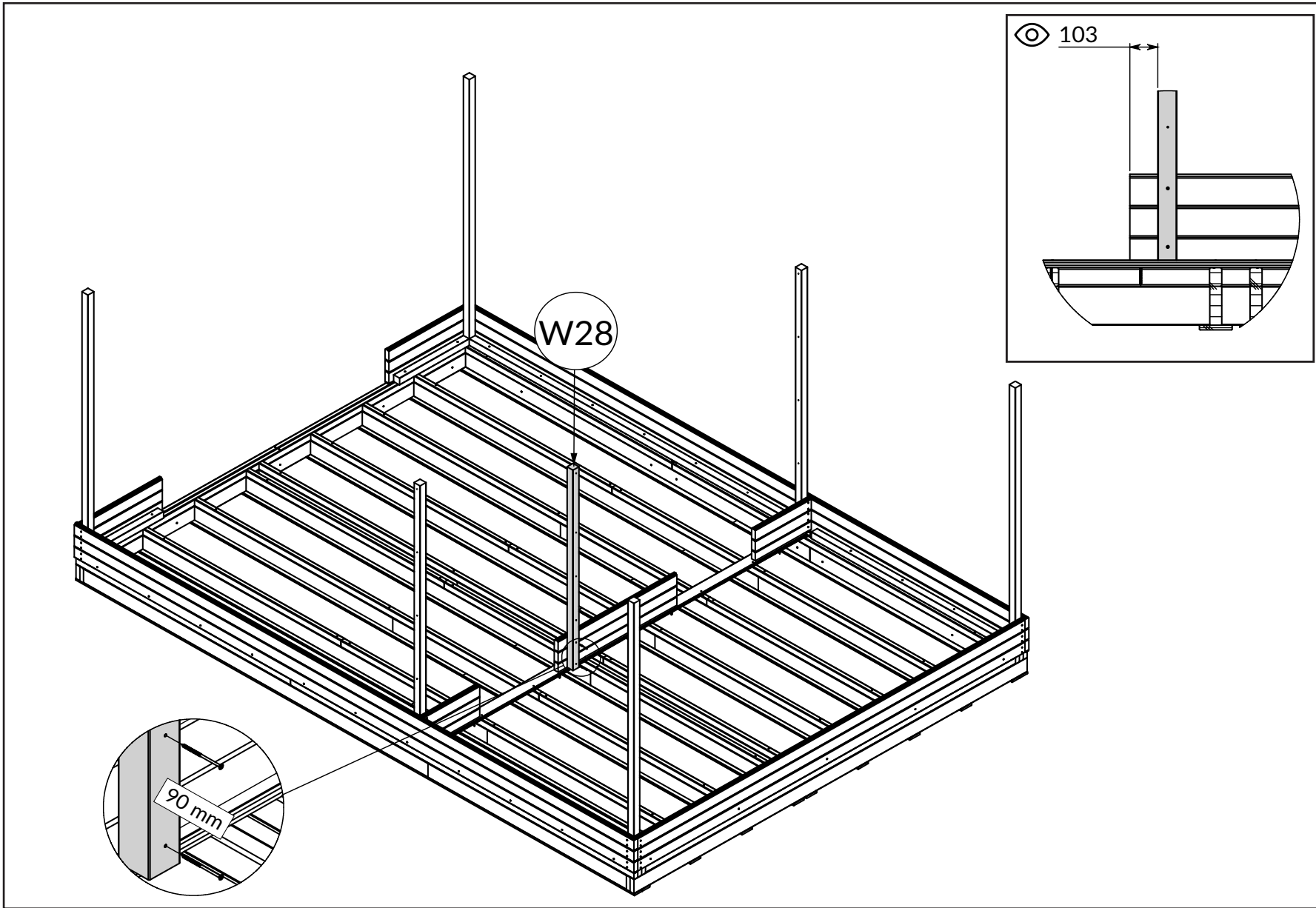

W28 x1

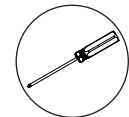
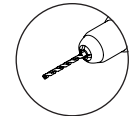
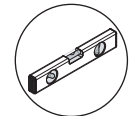
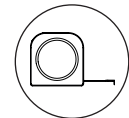

A|1→2→3→4→5→    B|1→2→3→4→5→6→7→8→9→10→11→12→13→14→15→16→17→18→19→20→  
 C|1→2→3→4→5→6→7→8→9→    D|1→2→3→4→5→6→7→8→    E|1→2→3→4→5→6→7→  
 F|1→2→3→4→5→    G|1→2→3→    H|1→2→3→    I|1→2→3→4→5→    J|1→2→3→4→

# B13

A|1→2→3→4→5→ B|1→2→3→4→5→6→7→8→9→10→11→12→13→14→15→16→17→18→19→20→  
C|1→2→3→4→5→6→7→8→9→ D|1→2→3→4→5→6→7→8→ E|1→2→3→4→5→6→7→  
F|1→2→3→4→5→ G|1→2→3→ H|1→2→3→ I|1→2→3→4→5→ J|1→2→3→4→

# B14

W52 x1

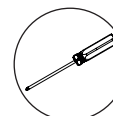
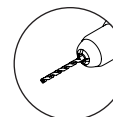
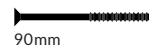
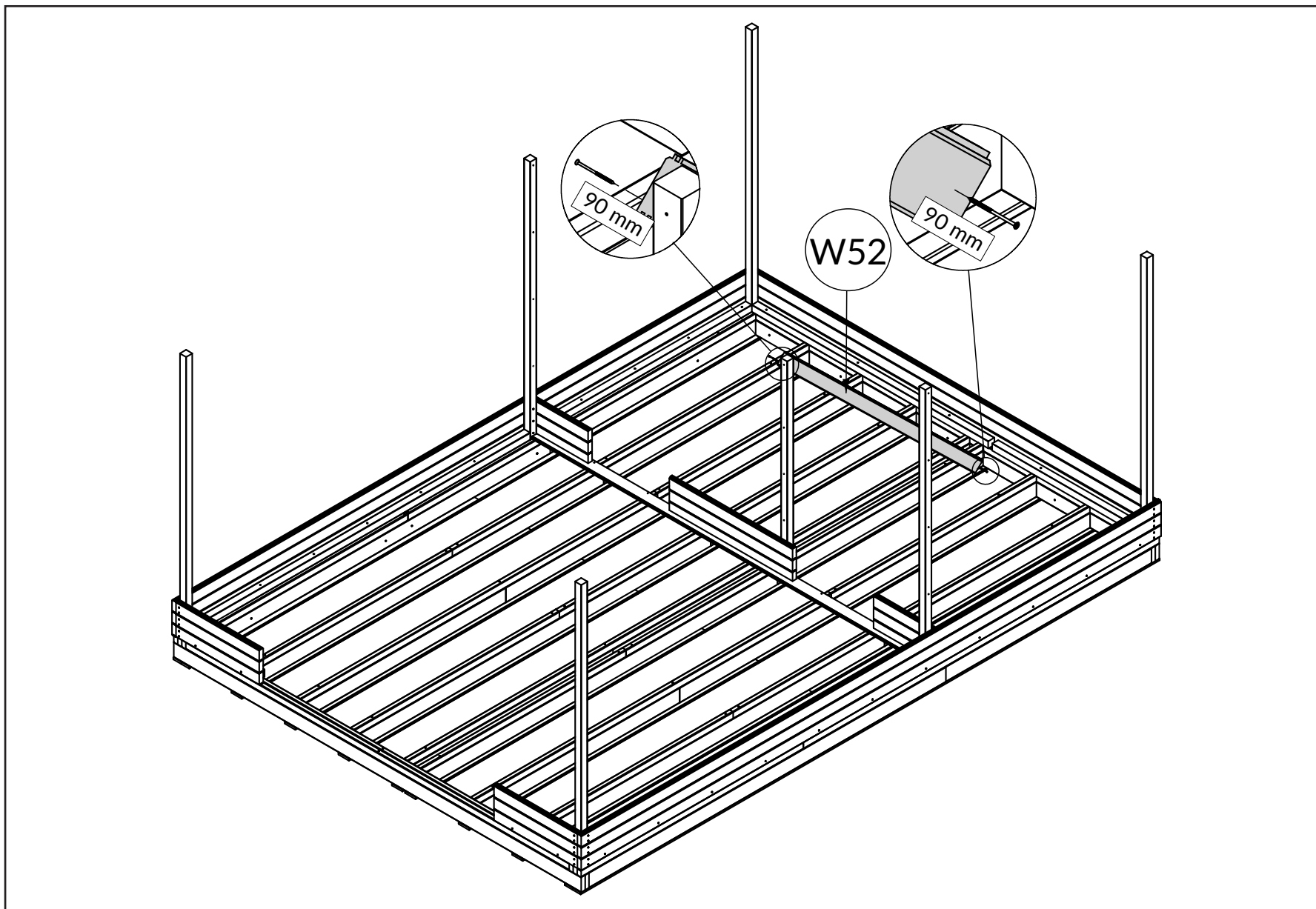

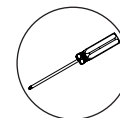
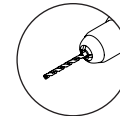
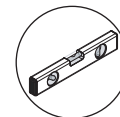
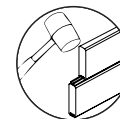
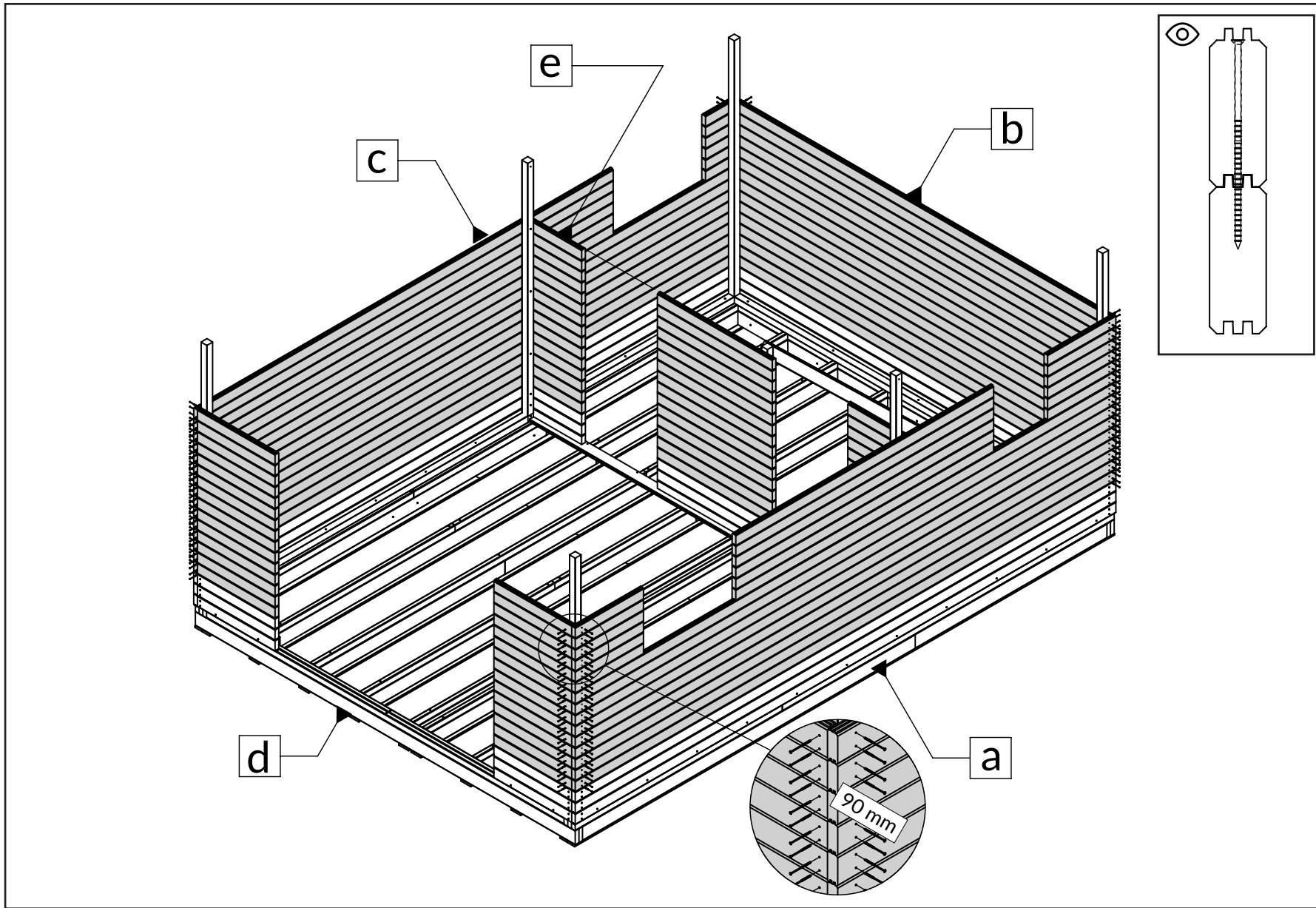

**A** | 1 → 2 → 3 → 4 → 5 →    **B** | 1 → 2 → 3 → 4 → 5 → 6 → 7 → 8 → 9 → 10 → 11 → 12 → 13 → 14 → 15 → 16 → 17 → 18 → 19 → 20 →  
**C** | 1 → 2 → 3 → 4 → 5 → 6 → 7 → 8 → 9 →    **D** | 1 → 2 → 3 → 4 → 5 → 6 → 7 → 8 →    **E** | 1 → 2 → 3 → 4 → 5 → 6 → 7 →  
**F** | 1 → 2 → 3 → 4 → 5 →    **G** | 1 → 2 → 3 →    **H** | 1 → 2 → 3 →    **I** | 1 → 2 → 3 → 4 → 5 →    **J** | 1 → 2 → 3 → 4 →

# B15

A|1→2→3→4→5→ B|1→2→3→4→5→6→7→8→9→10→11→12→13→14→15→16→17→18→19→20→  
C|1→2→3→4→5→6→7→8→9→ D|1→2→3→4→5→6→7→8→ E|1→2→3→4→5→6→7→  
F|1→2→3→4→5→ G|1→2→3→ H|1→2→3→ I|1→2→3→4→5→ J|1→2→3→4→

# B15.1

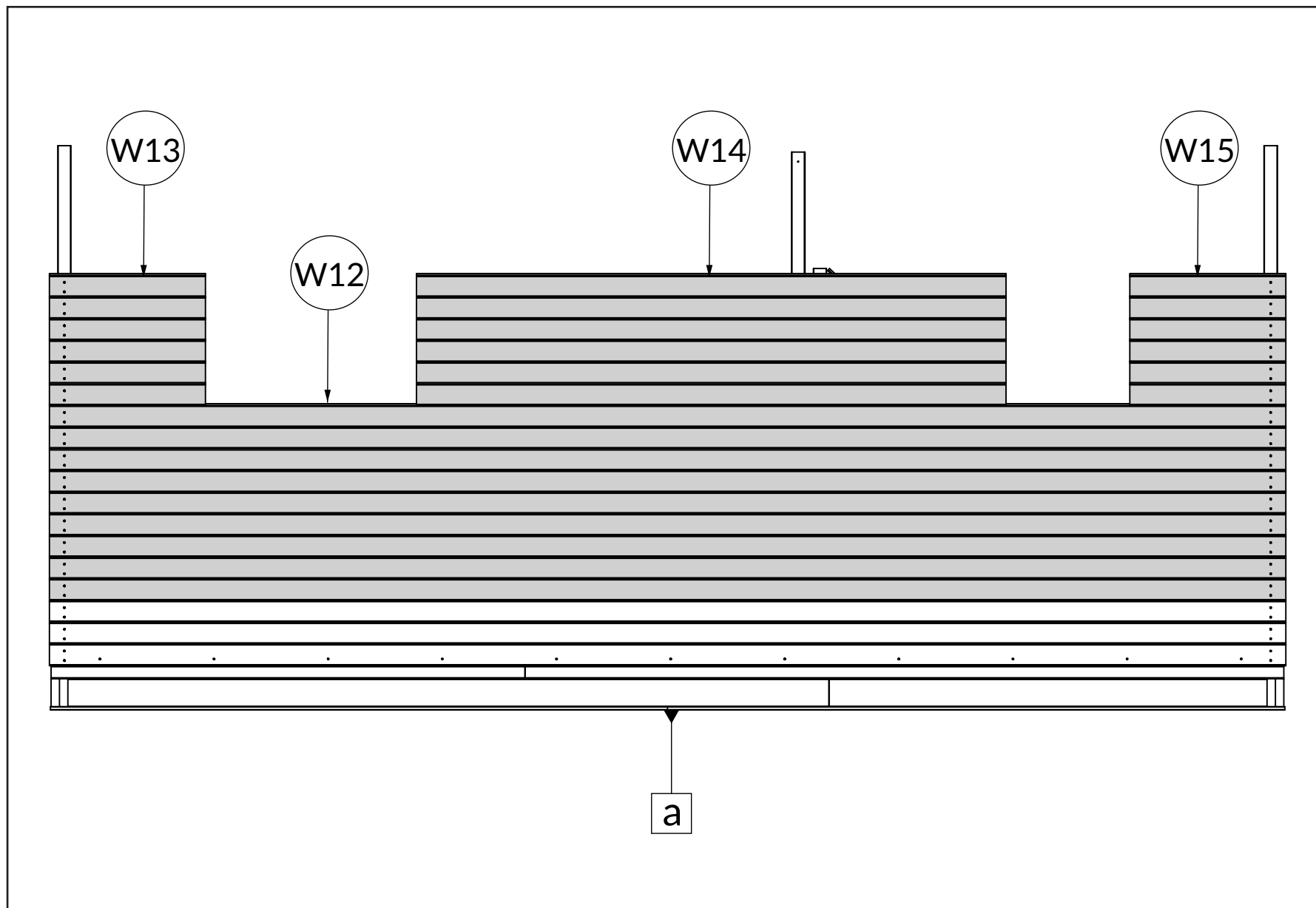

W12 x9

W13 x6

W14 x6

W15 x6

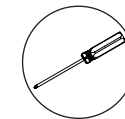
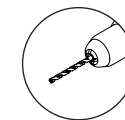
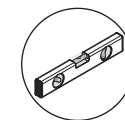
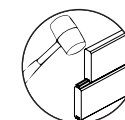
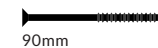

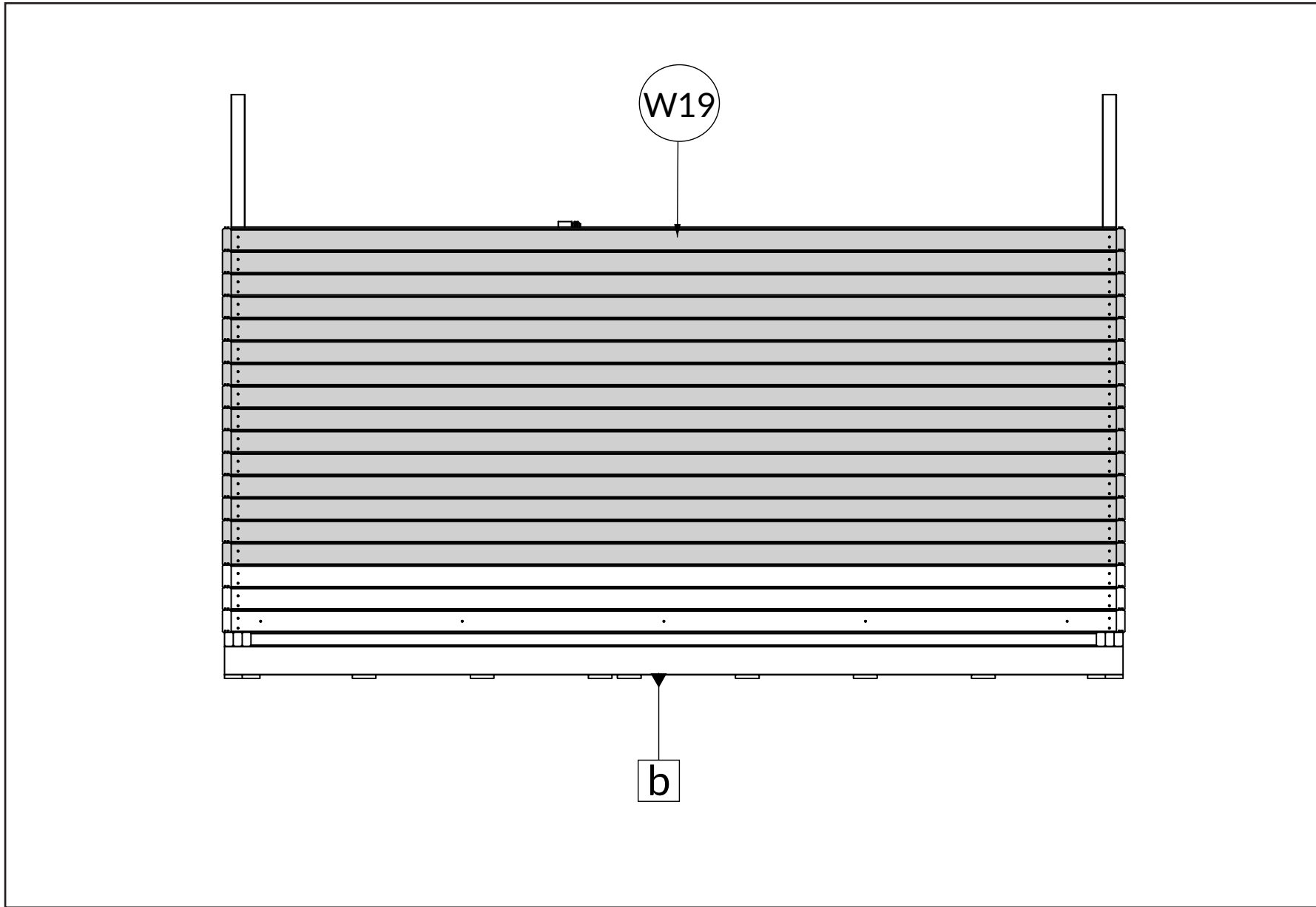

W19 x15

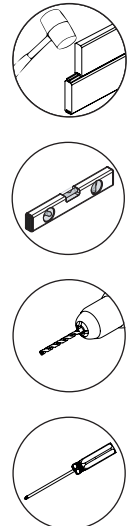
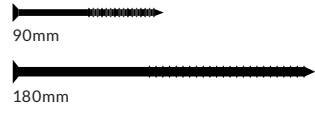

A|1→2→3→4→5→    B|1→2→3→4→5→6→7→8→9→10→11→12→13→14→15→16→17→18→19→20→  
 C|1→2→3→4→5→6→7→8→9→    D|1→2→3→4→5→6→7→8→    E|1→2→3→4→5→6→7→  
 F|1→2→3→4→5→    G|1→2→3→    H|1→2→3→    I|1→2→3→4→5→    J|1→2→3→4→

# B15.2

A|1→2→3→4→5→ B|1→2→3→4→5→6→7→8→9→10→11→12→13→14→15→16→17→18→19→20→  
C|1→2→3→4→5→6→7→8→9→ D|1→2→3→4→5→6→7→8→ E|1→2→3→4→5→6→7→  
F|1→2→3→4→5→ G|1→2→3→ H|1→2→3→ I|1→2→3→4→5→ J|1→2→3→4→

# B15.3

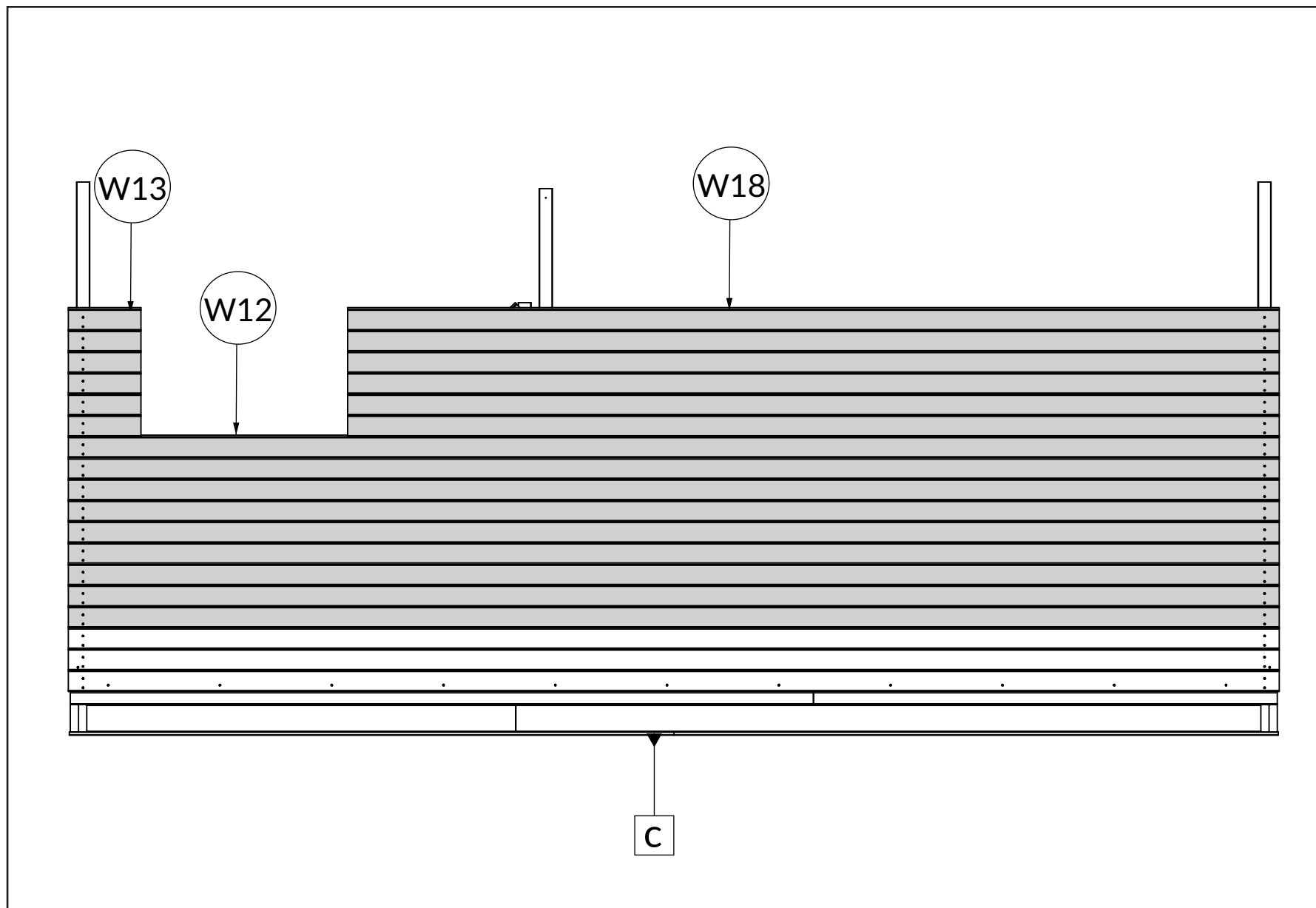

W12 x9

W13 x6

W18 x6

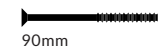

90mm



180mm

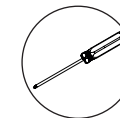
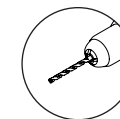
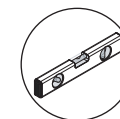
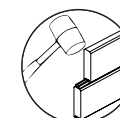

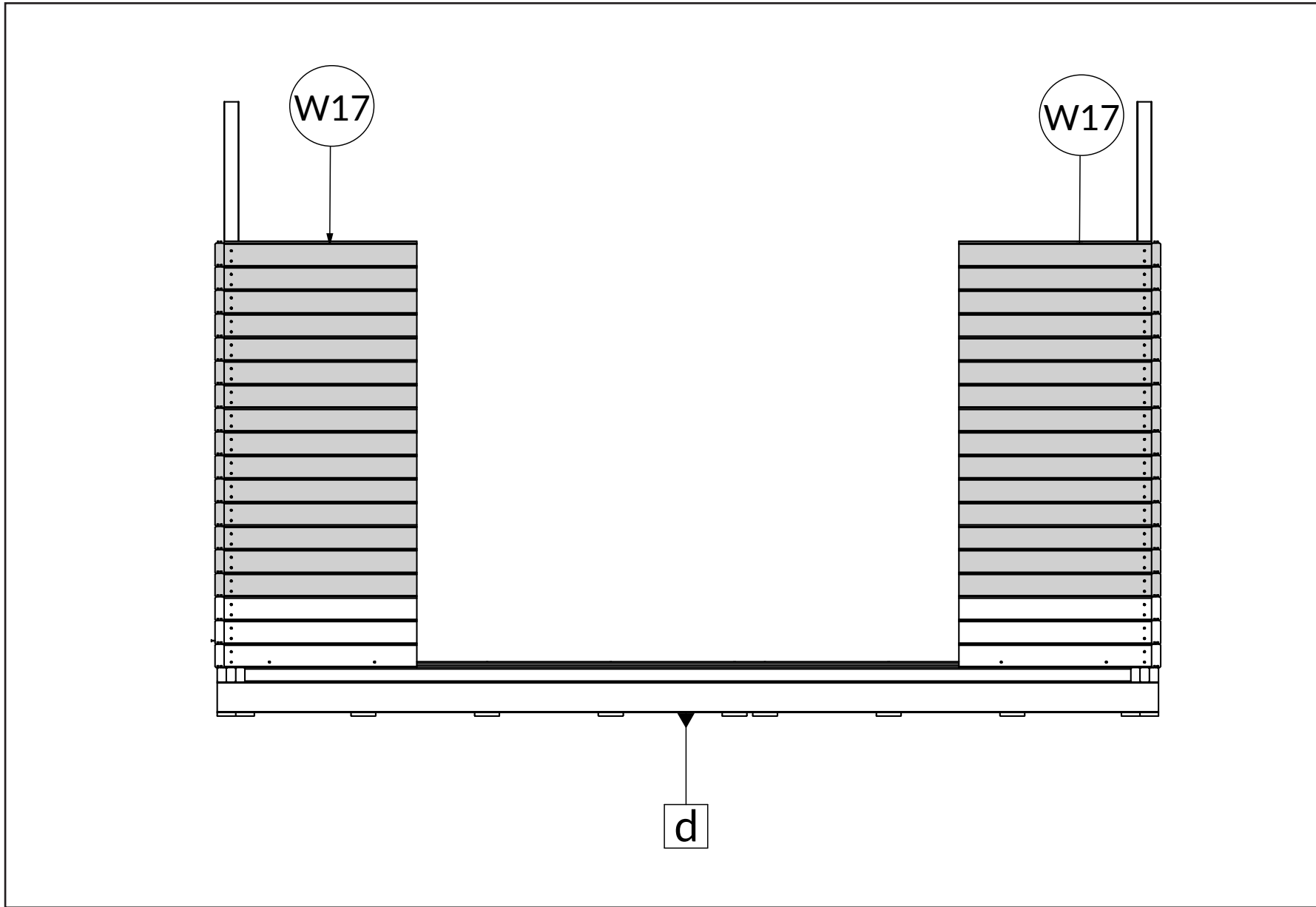

W17 x30

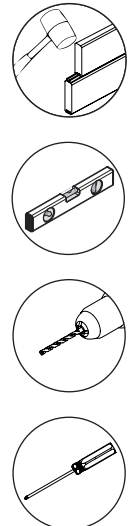
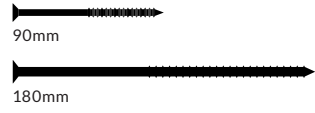

A|1→2→3→4→5→    B|1→2→3→4→5→6→7→8→9→10→11→12→13→14→15→16→17→18→19→20→  
 C|1→2→3→4→5→6→7→8→9→    D|1→2→3→4→5→6→7→8→    E|1→2→3→4→5→6→7→  
 F|1→2→3→4→5→    G|1→2→3→    H|1→2→3→    I|1→2→3→4→5→    J|1→2→3→4→

# B15.4

A|1→2→3→4→5→ B|1→2→3→4→5→6→7→8→9→10→11→12→13→14→15→16→17→18→19→20→  
C|1→2→3→4→5→6→7→8→9→ D|1→2→3→4→5→6→7→8→ E|1→2→3→4→5→6→7→  
F|1→2→3→4→5→ G|1→2→3→ H|1→2→3→ I|1→2→3→4→5→ J|1→2→3→4→

# B15.5

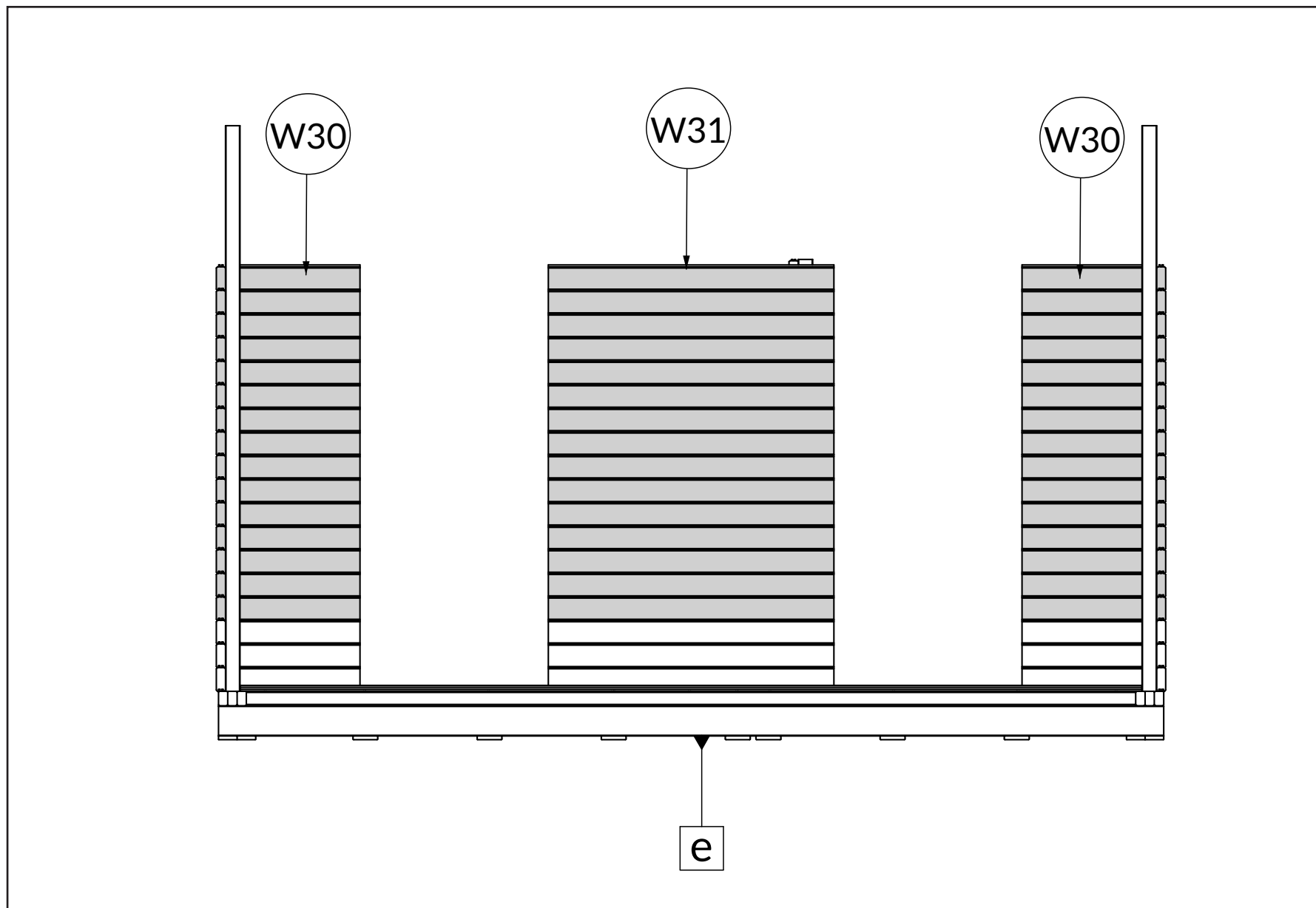

W30 x30

W31 x15

90mm

180mm

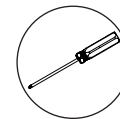
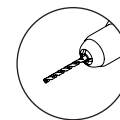
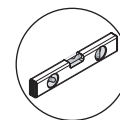
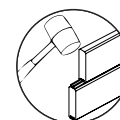

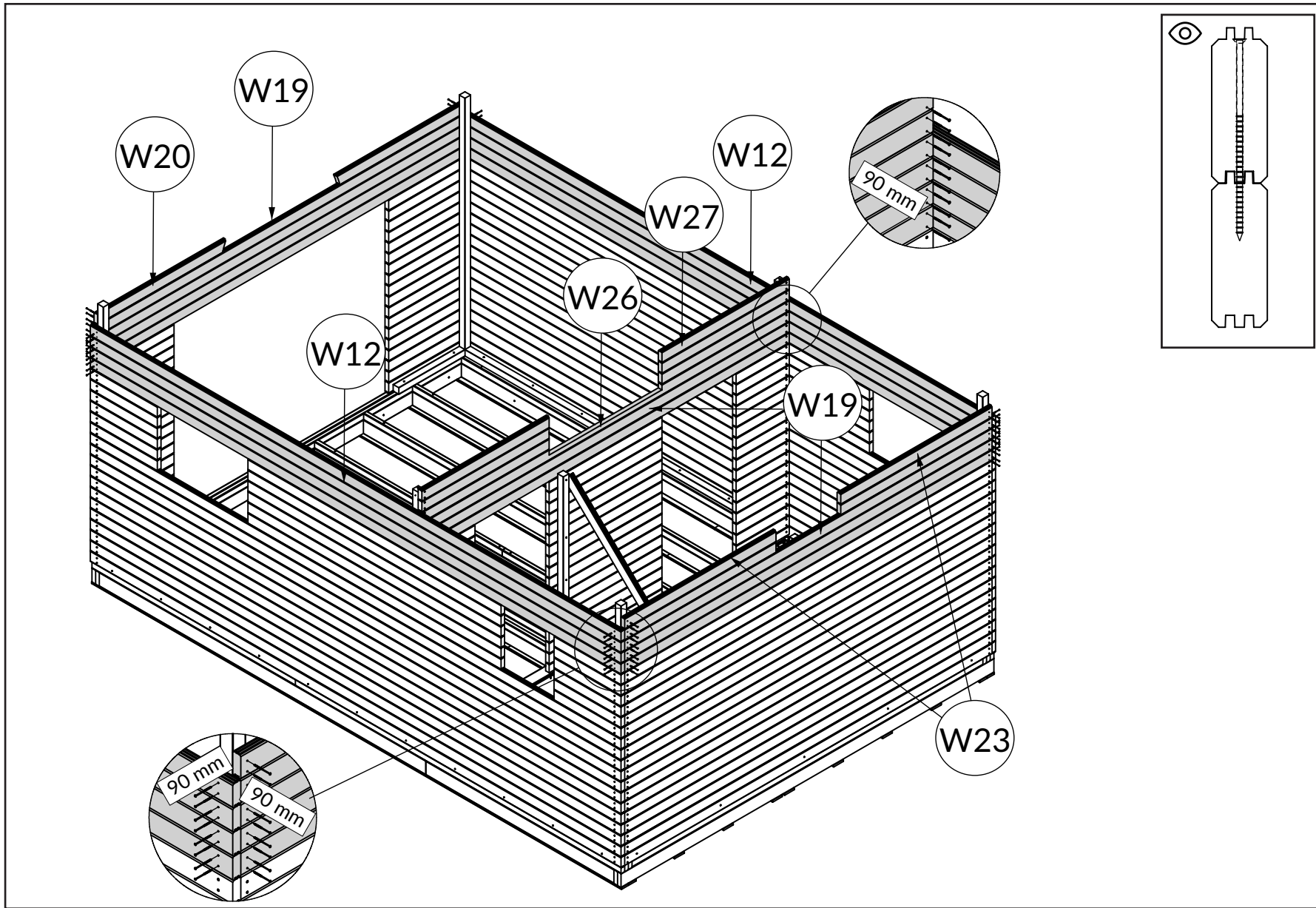

- W12 x8
- W19 x9
- W20 x2
- W23 x4
- W26 x1
- W27 x6

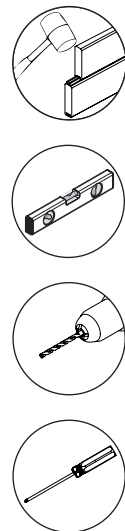
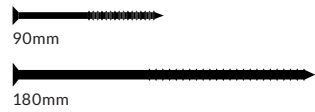

A|1→2→3→4→5→    B|1→2→3→4→5→6→7→8→9→10→11→12→13→14→15→16→17→18→19→20→  
 C|1→2→3→4→5→6→7→8→9→    D|1→2→3→4→5→6→7→8→    E|1→2→3→4→5→6→7→  
 F|1→2→3→4→5→    G|1→2→3→    H|1→2→3→    I|1→2→3→4→5→    J|1→2→3→4→

# B16

A|1→2→3→4→5→ B|1→2→3→4→5→6→7→8→9→10→11→12→13→14→15→16→17→18→19→20→  
C|1→2→3→4→5→6→7→8→9→ D|1→2→3→4→5→6→7→8→ E|1→2→3→4→5→6→7→  
F|1→2→3→4→5→ G|1→2→3→ H|1→2→3→ I|1→2→3→4→5→ J|1→2→3→4→

# B17

W29 x2

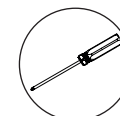
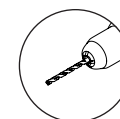
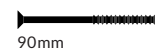
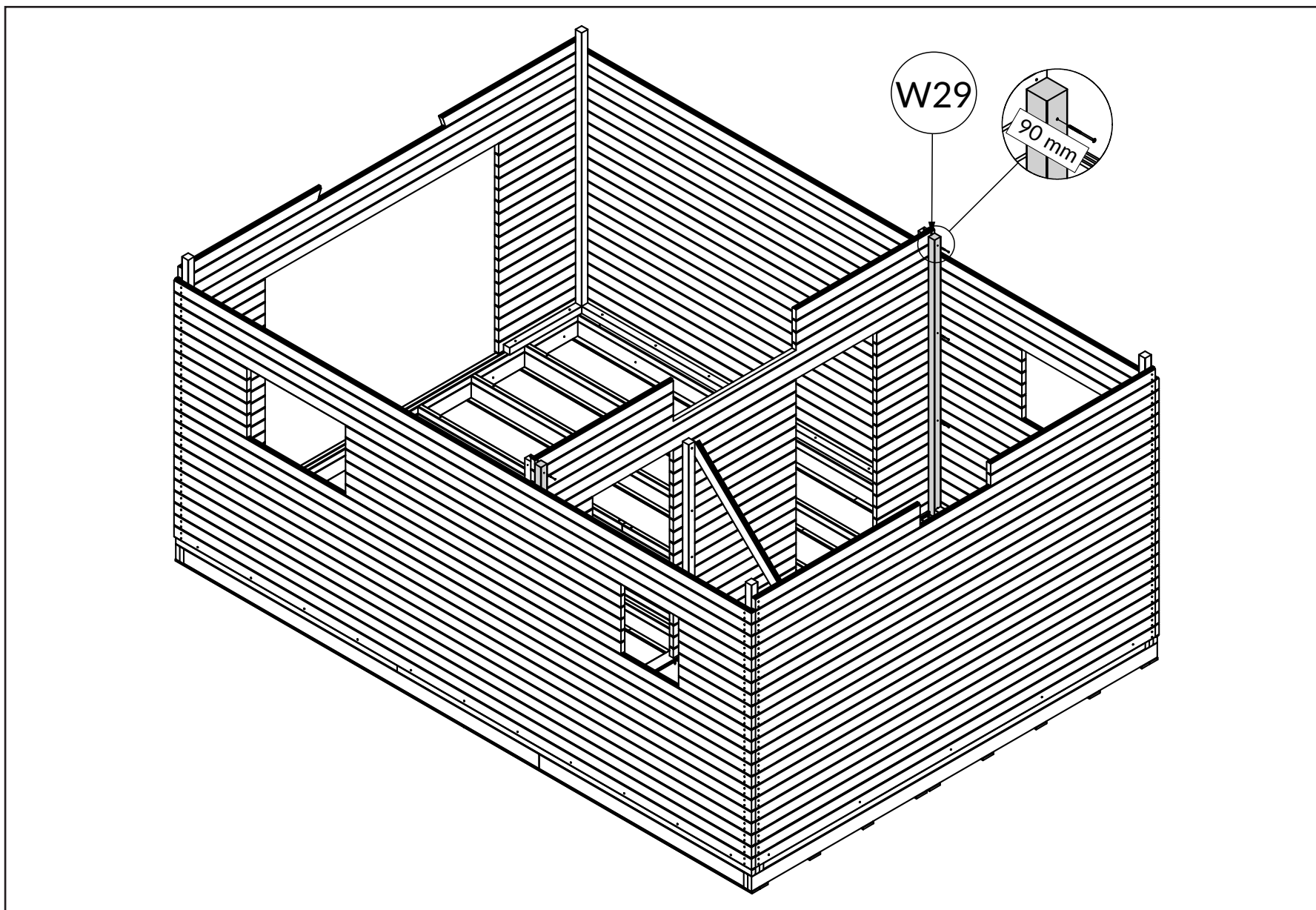

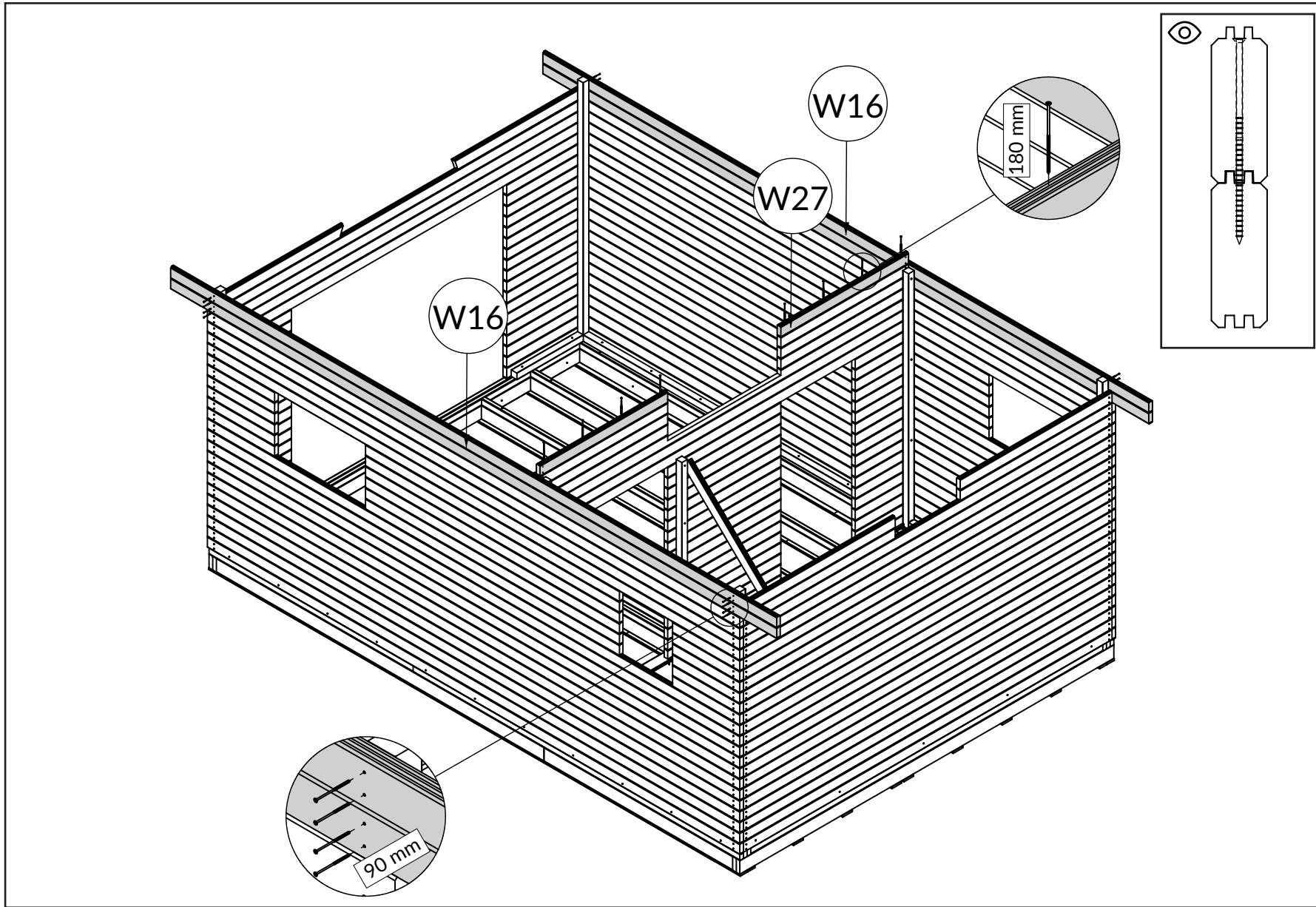

W16 x4

W27 x2

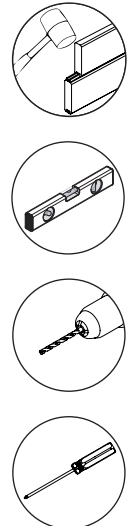
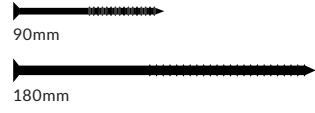

A|1→2→3→4→5→ B|1→2→3→4→5→6→7→8→9→10→11→12→13→14→15→16→17→18→19→20→  
 C|1→2→3→4→5→6→7→8→9→ D|1→2→3→4→5→6→7→8→ E|1→2→3→4→5→6→7→  
 F|1→2→3→4→5→ G|1→2→3→ H|1→2→3→ I|1→2→3→4→5→ J|1→2→3→4→

# B18

A|1→2→3→4→5→ B|1→2→3→4→5→6→7→8→9→10→11→12→13→14→15→16→17→18→19→20→  
C|1→2→3→4→5→6→7→8→9→ D|1→2→3→4→5→6→7→8→ E|1→2→3→4→5→6→7→  
F|1→2→3→4→5→ G|1→2→3→ H|1→2→3→ I|1→2→3→4→5→ J|1→2→3→4→

# B19

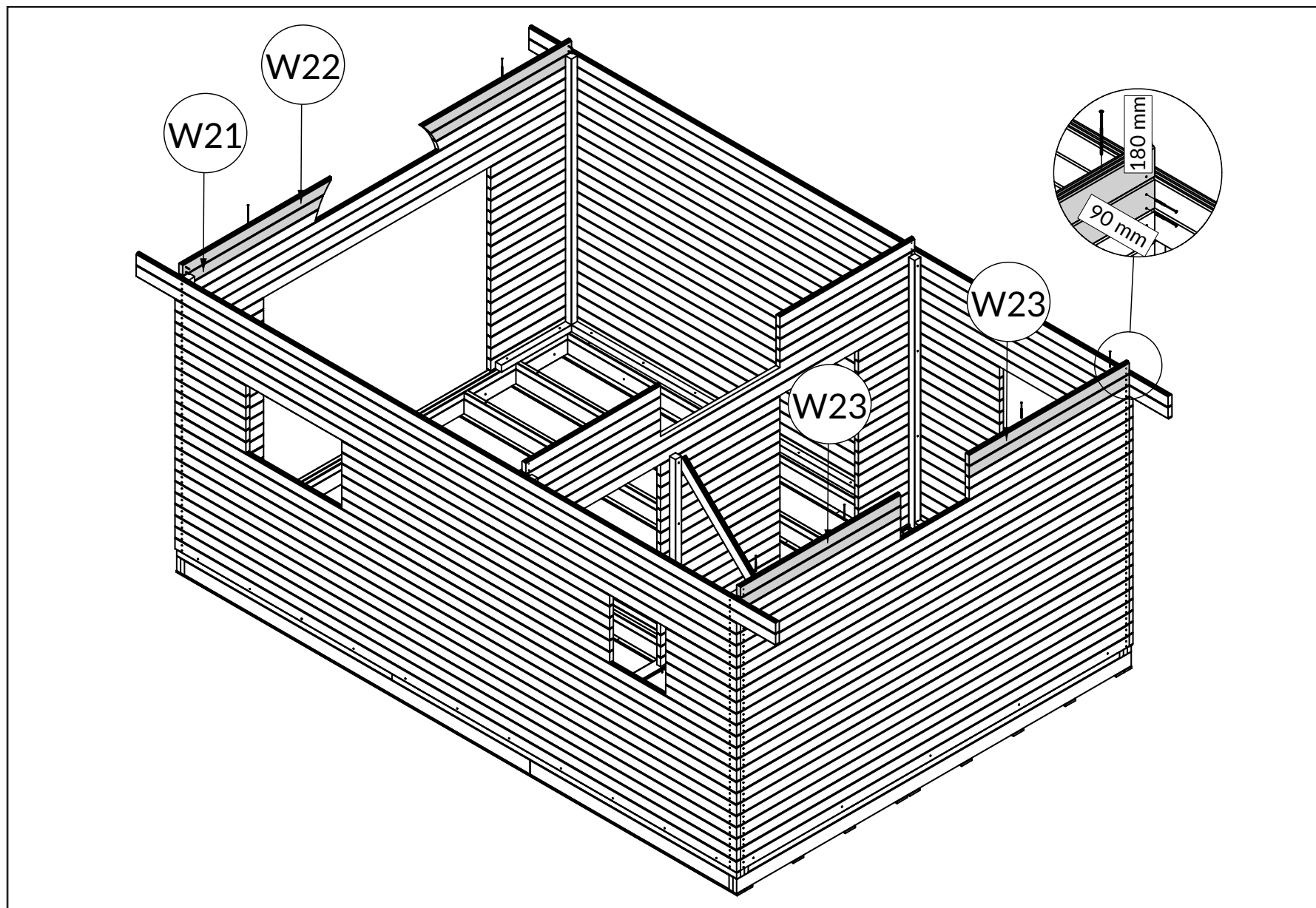

W21 x2

W22 x2

W23 x4

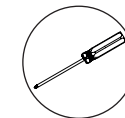
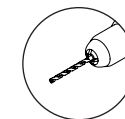
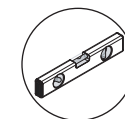
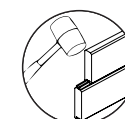

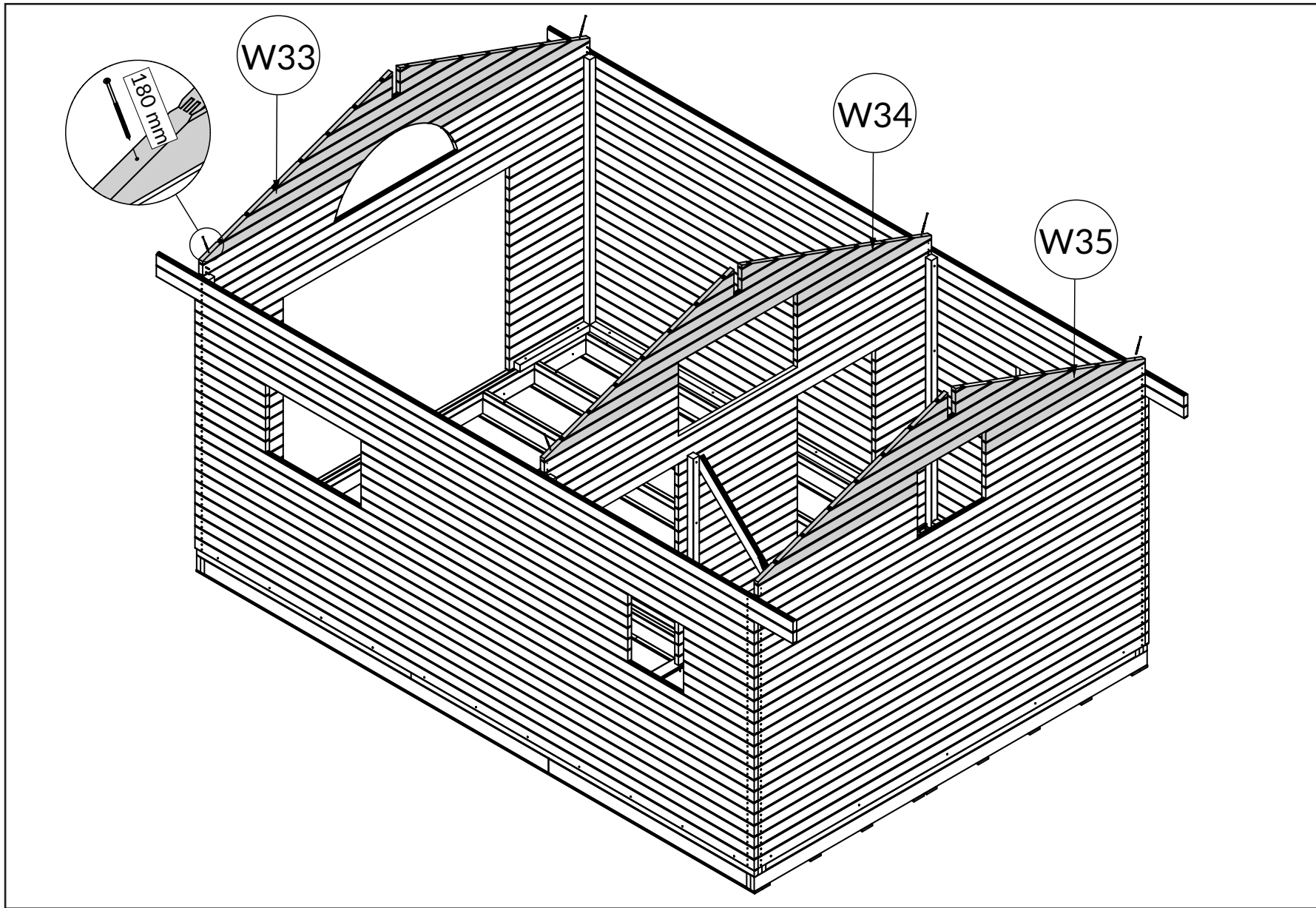

- W33 x1
- W34 x1
- W35 x1

180mm

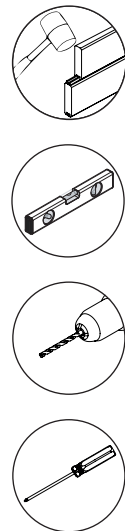



A|1→2→3→4→5→ B|1→2→3→4→5→6→7→8→9→10→11→12→13→14→15→16→17→18→19→20→  
 C|1→2→3→4→5→6→7→8→9→ D|1→2→3→4→5→6→7→8→ E|1→2→3→4→5→6→7→  
 F|1→2→3→4→5→ G|1→2→3→ H|1→2→3→ I|1→2→3→4→5→ J|1→2→3→4→

# B20

C

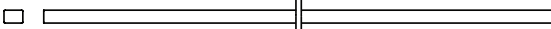
C

W36    
 ×2 (70x45) x 4360mm (VT1)

W37    
 ×5 (146x44) x 2440mm (VT2)

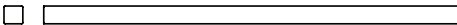
W28    
 ×1 (70x70) x 2061mm (P1)

W11    
 ×2 (70x70) x 3136mm (PT2)

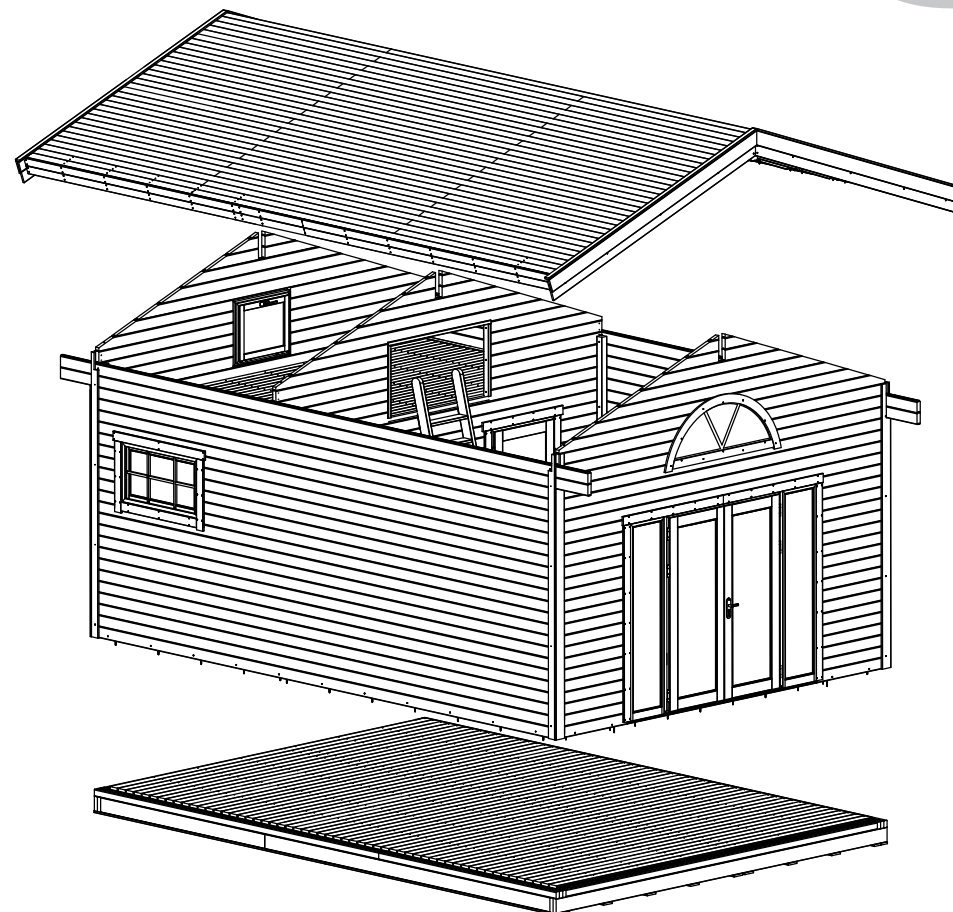



V-1

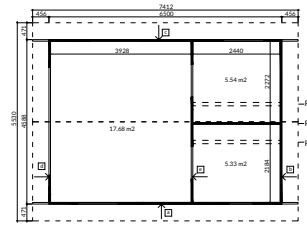

e	P1	W36		x2	W36.1	W36.2
	P2	W36		x2	W36.3	W36.4
	P3	W36		x2	W36.5	W36.6

V-1



A|1→2→3→4→5→ B|1→2→3→4→5→6→7→8→9→10→11→12→13→14→15→16→17→18→19→20→  
 C|1→2→3→4→5→6→7→8→9→ D|1→2→3→4→5→6→7→8→ E|1→2→3→4→5→6→7→  
 F|1→2→3→4→5→ G|1→2→3→ H|1→2→3→ I|1→2→3→4→5→ J|1→2→3→4→

# C1

A|1→2→3→4→5→ B|1→2→3→4→5→6→7→8→9→10→11→12→13→14→15→16→17→18→19→20→  
C|1→2→3→4→5→6→7→8→9→ D|1→2→3→4→5→6→7→8→ E|1→2→3→4→5→6→7→  
F|1→2→3→4→5→ G|1→2→3→ H|1→2→3→ I|1→2→3→4→5→ J|1→2→3→4→

# C2

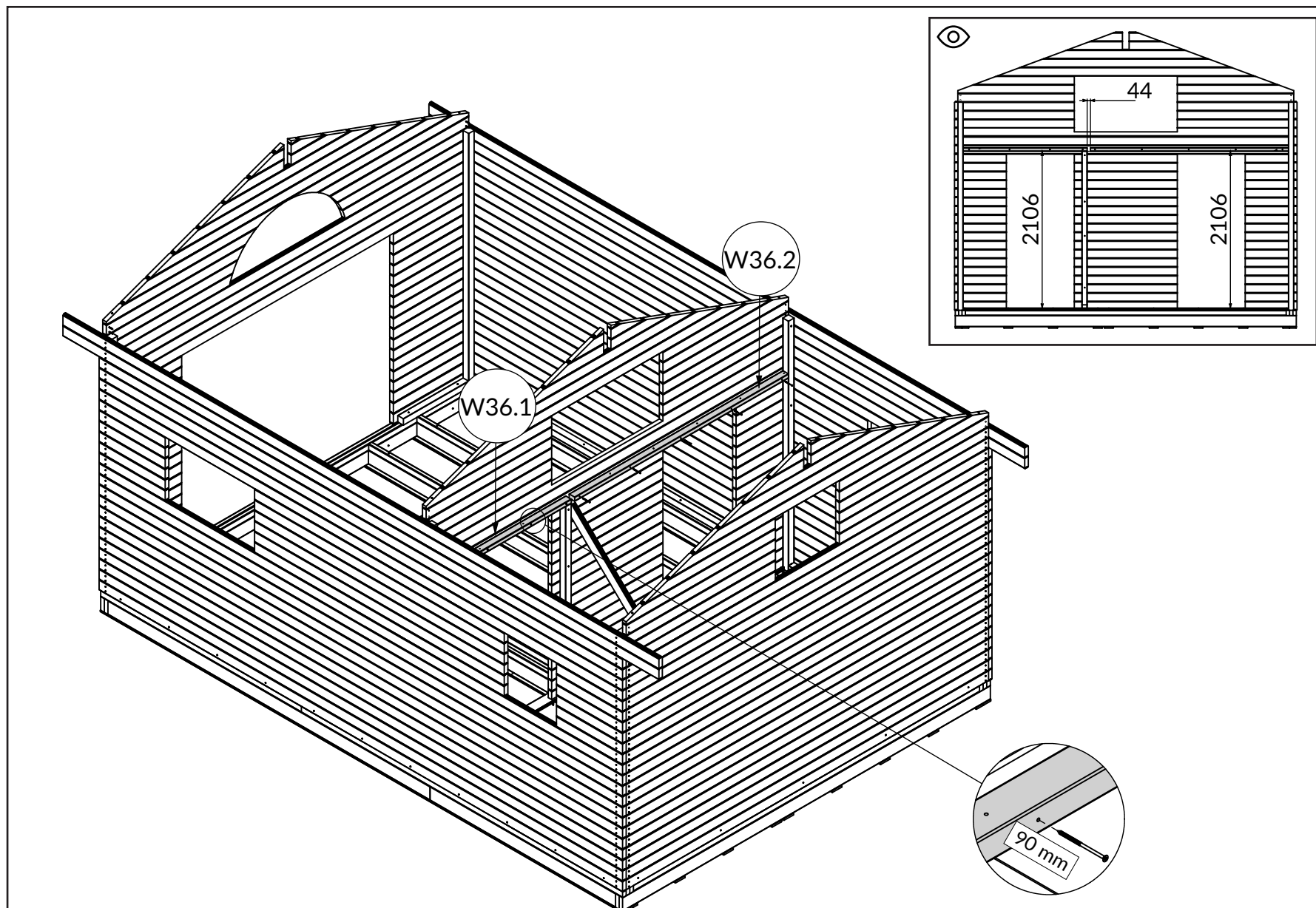

W36.1 x1

W36.2 x1

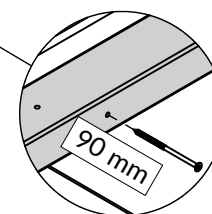
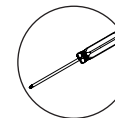
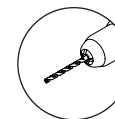
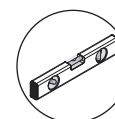
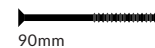

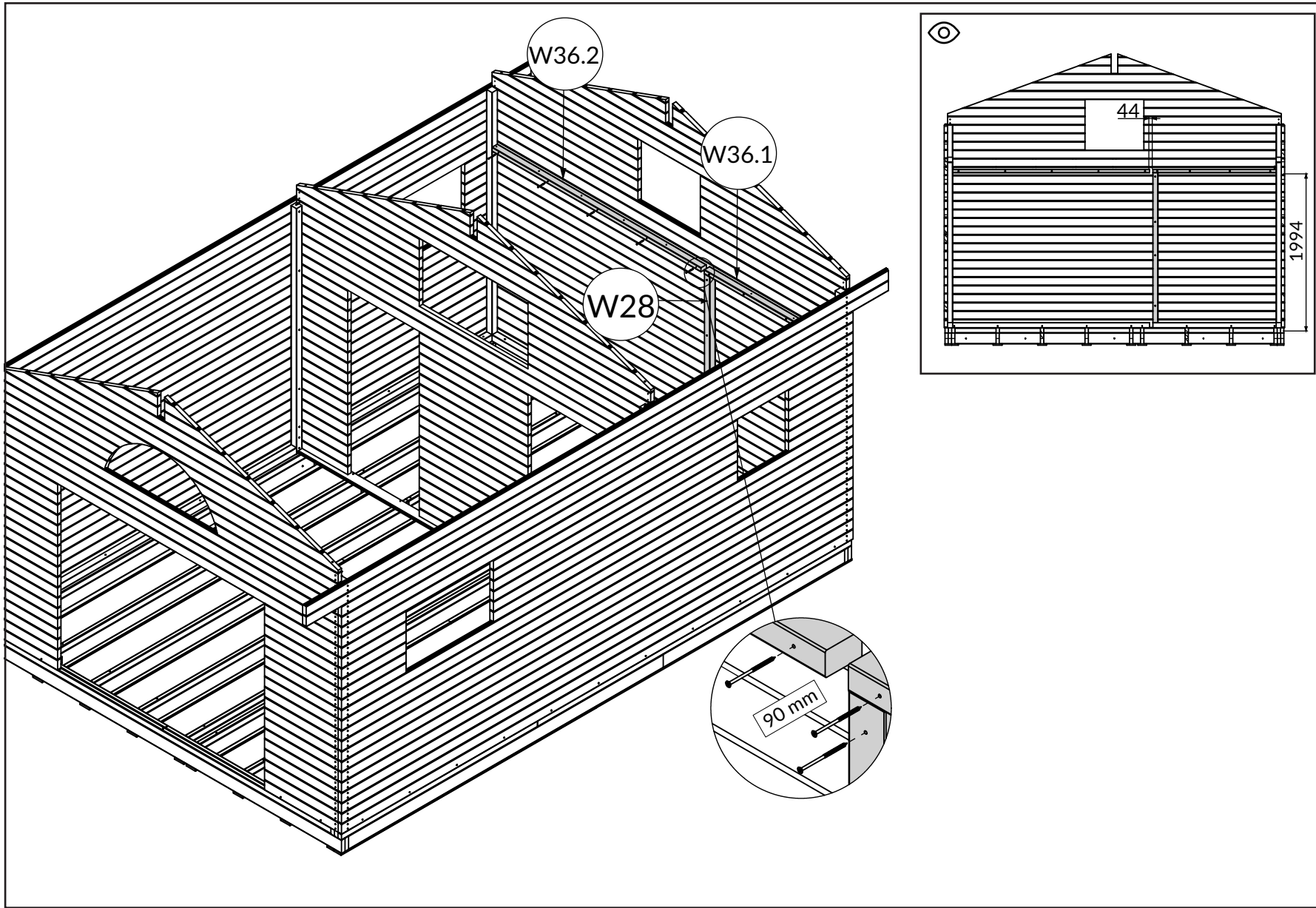

- W36.1 x1
- W36.2 x1
- W28 x1

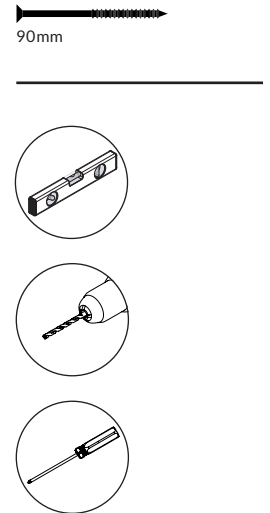

A|1→2→3→4→5→ B|1→2→3→4→5→6→7→8→9→10→11→12→13→14→15→16→17→18→19→20→  
 C|1→2→3→4→5→6→7→8→9→ D|1→2→3→4→5→6→7→8→ E|1→2→3→4→5→6→7→  
 F|1→2→3→4→5→ G|1→2→3→ H|1→2→3→ I|1→2→3→4→5→ J|1→2→3→4→



A|1→2→3→4→5→ B|1→2→3→4→5→6→7→8→9→10→11→12→13→14→15→16→17→18→19→20→  
 C|1→2→3→4→5→6→7→8→9→ D|1→2→3→4→5→6→7→8→ E|1→2→3→4→5→6→7→  
 F|1→2→3→4→5→ G|1→2→3→ H|1→2→3→ I|1→2→3→4→5→ J|1→2→3→4→

# C4



V-1

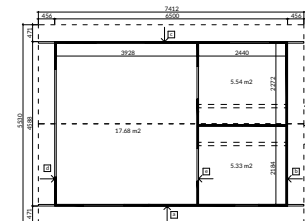

V-1

e	V-1	W11		x2	W11.9
	V-2	W11		x2	W11.10

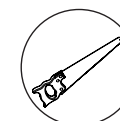

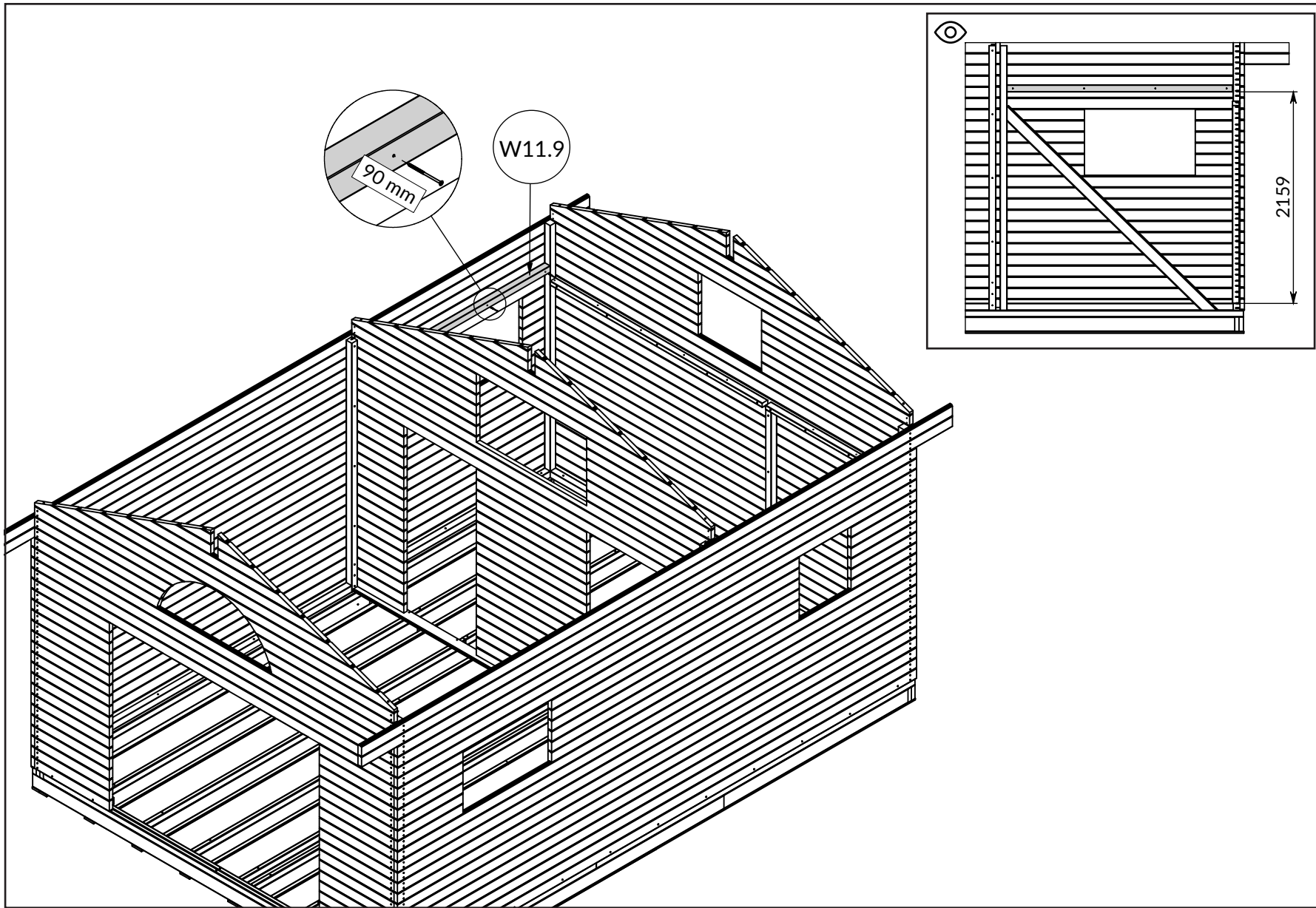

W11.9 x1

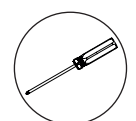
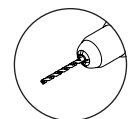
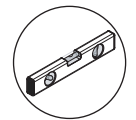

A|1→2→3→4→5→ B|1→2→3→4→5→6→7→8→9→10→11→12→13→14→15→16→17→18→19→20→  
 C|1→2→3→4→5→6→7→8→9→ D|1→2→3→4→5→6→7→8→ E|1→2→3→4→5→6→7→  
 F|1→2→3→4→5→ G|1→2→3→ H|1→2→3→ I|1→2→3→4→5→ J|1→2→3→4→

# C5

A|1→2→3→4→5→ B|1→2→3→4→5→6→7→8→9→10→11→12→13→14→15→16→17→18→19→20→  
C|1→2→3→4→5→6→7→8→9→ D|1→2→3→4→5→6→7→8→ E|1→2→3→4→5→6→7→  
F|1→2→3→4→5→ G|1→2→3→ H|1→2→3→ I|1→2→3→4→5→ J|1→2→3→4→

# C6

W11.9 x1

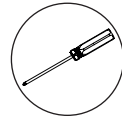
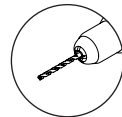
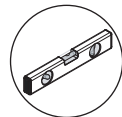
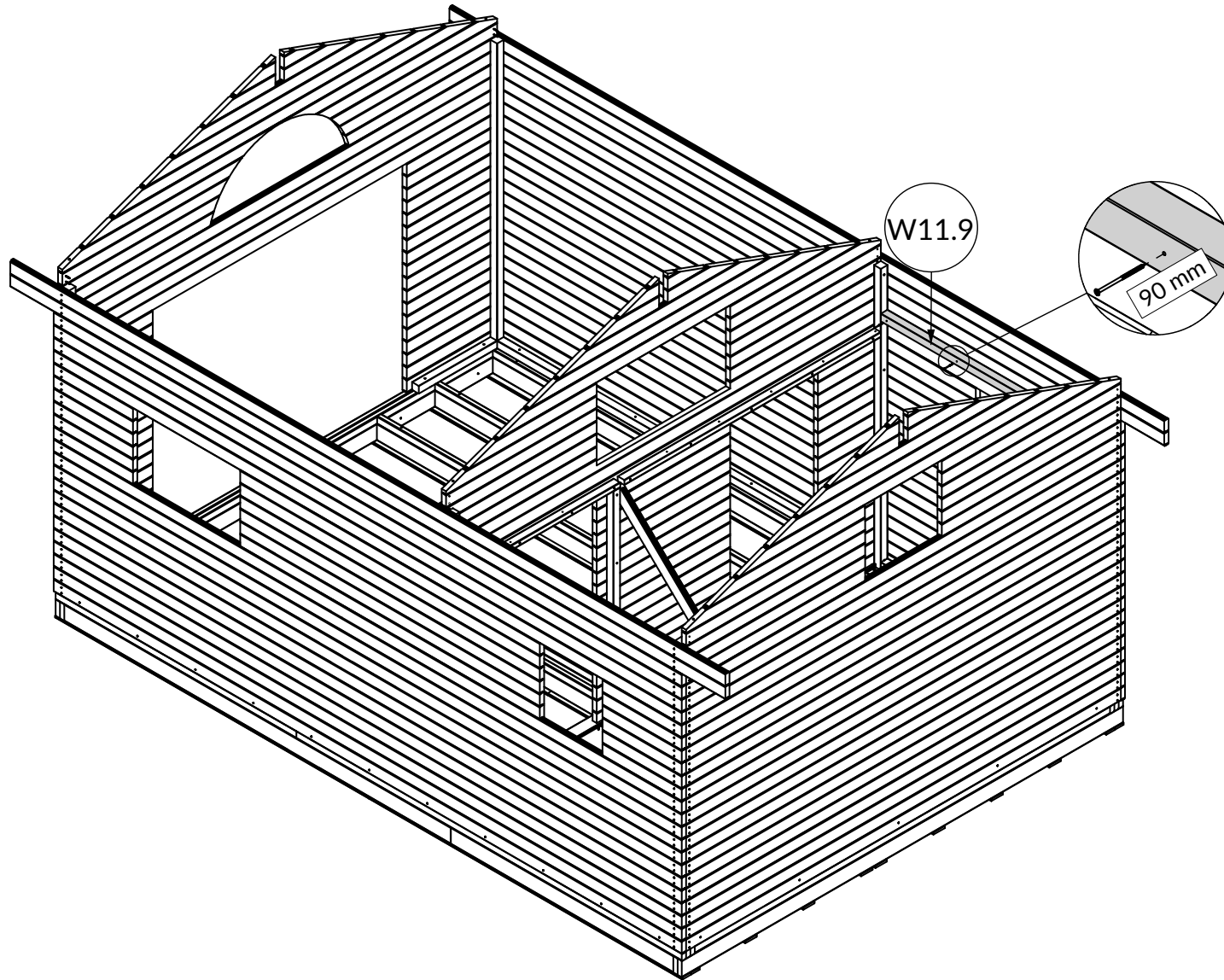



V-1

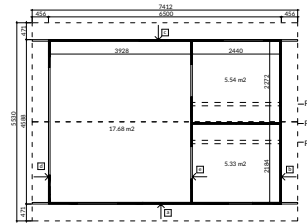

V-1

e	V-1	W37		x9	W37.1
	V-2	W37		x9	W37.2



A|1→2→3→4→5→ B|1→2→3→4→5→6→7→8→9→10→11→12→13→14→15→16→17→18→19→20→  
 C|1→2→3→4→5→6→7→8→9→ D|1→2→3→4→5→6→7→8→ E|1→2→3→4→5→6→7→  
 F|1→2→3→4→5→ G|1→2→3→ H|1→2→3→ I|1→2→3→4→5→ J|1→2→3→4→

# C7

# C8

A|1→2→3→4→5→ B|1→2→3→4→5→6→7→8→9→10→11→12→13→14→15→16→17→18→19→20→  
C|1→2→3→4→5→6→7→8→9→ D|1→2→3→4→5→6→7→8→ E|1→2→3→4→5→6→7→  
F|1→2→3→4→5→ G|1→2→3→ H|1→2→3→ I|1→2→3→4→5→ J|1→2→3→4→

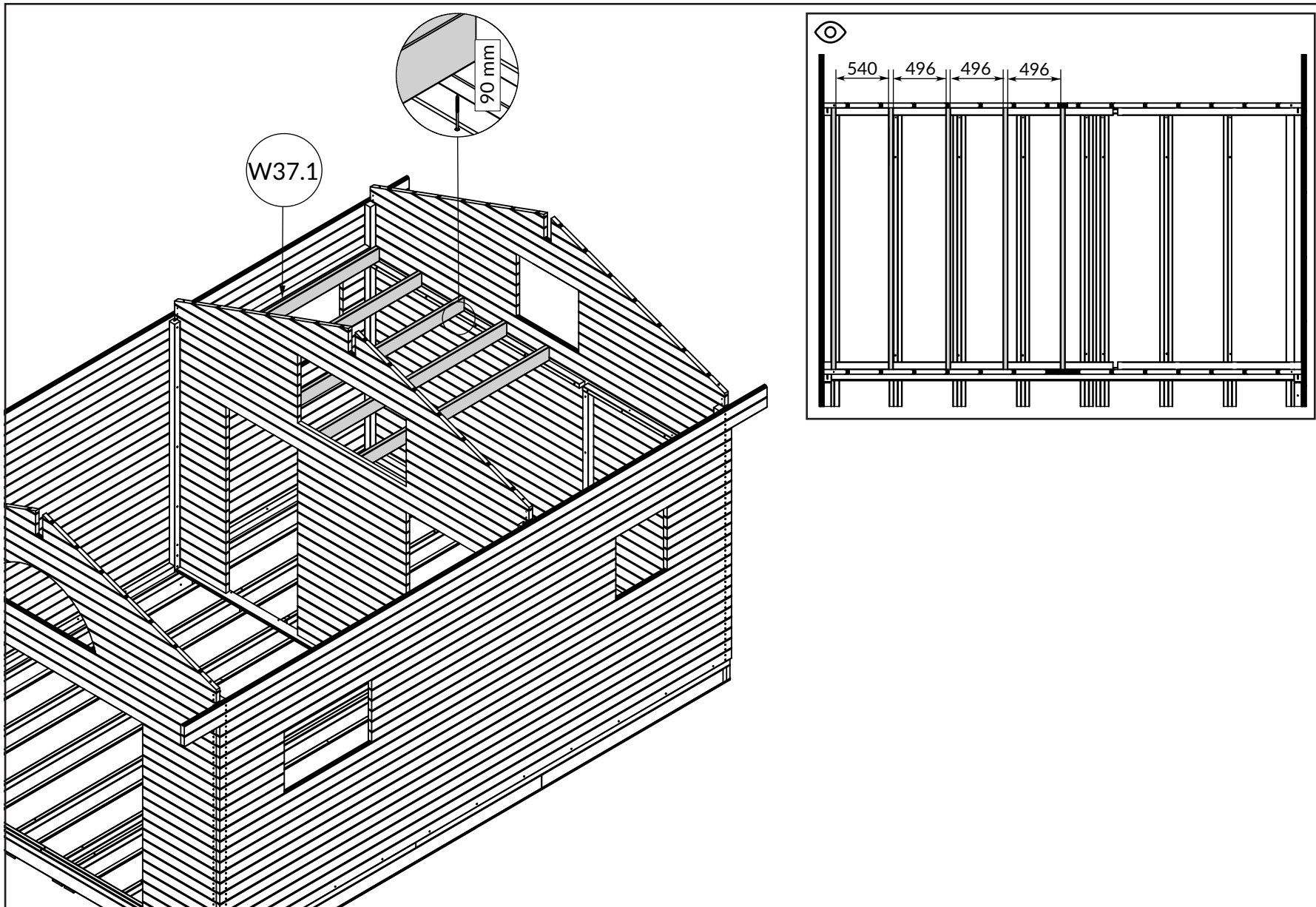

W37.1 x9

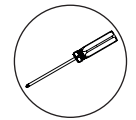
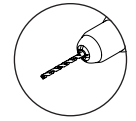
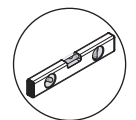

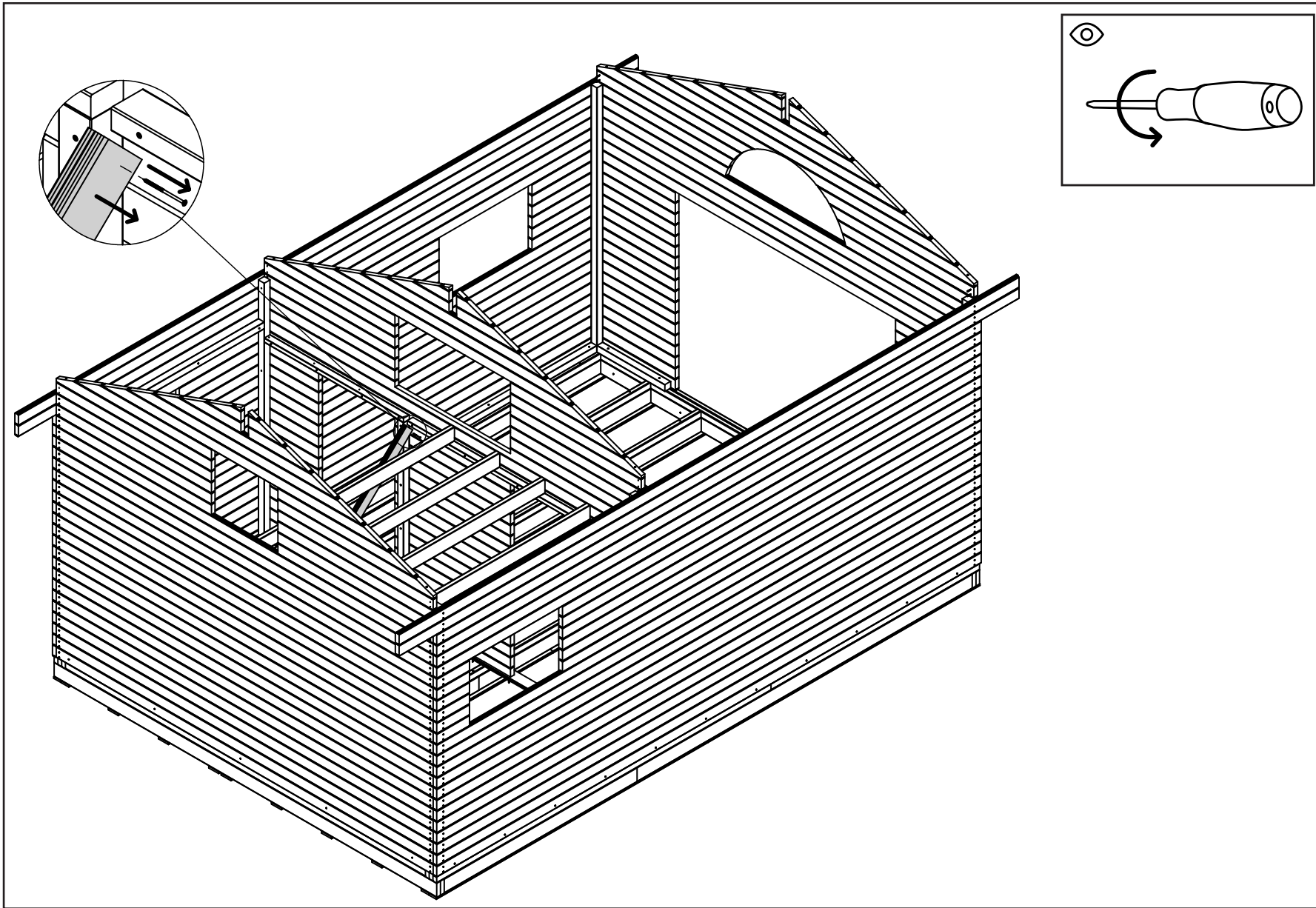

A|1→2→3→4→5→ B|1→2→3→4→5→6→7→8→9→10→11→12→13→14→15→16→17→18→19→20→  
 C|1→2→3→4→5→6→7→8→9→ D|1→2→3→4→5→6→7→8→ E|1→2→3→4→5→6→7→  
 F|1→2→3→4→5→ G|1→2→3→ H|1→2→3→ I|1→2→3→4→5→ J|1→2→3→4→

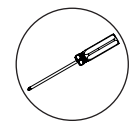

# C9

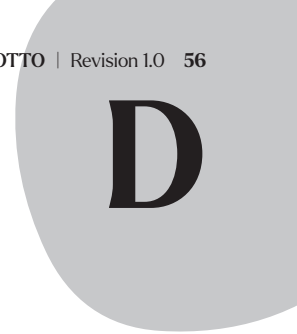

# D

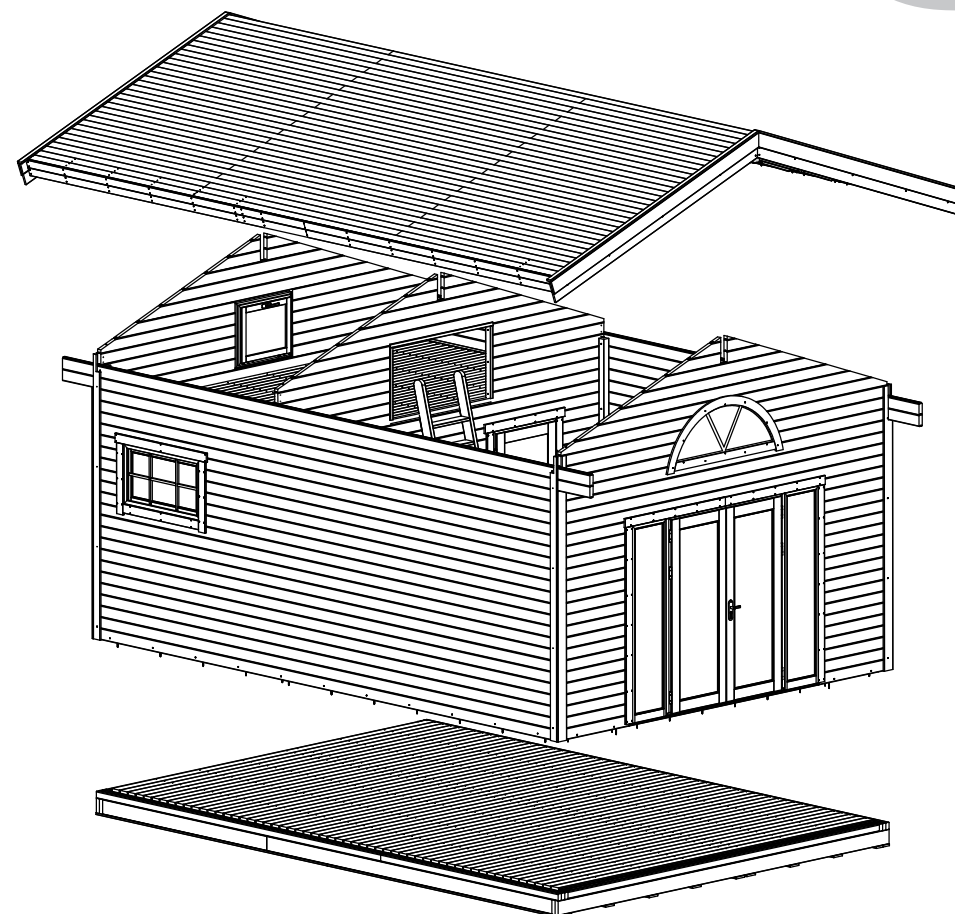
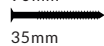
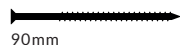
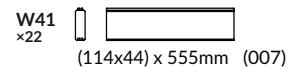
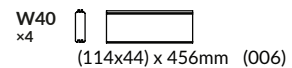
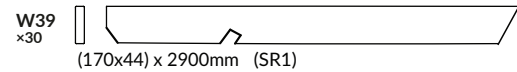
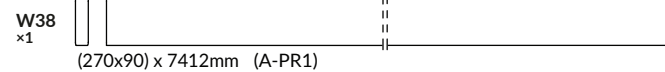

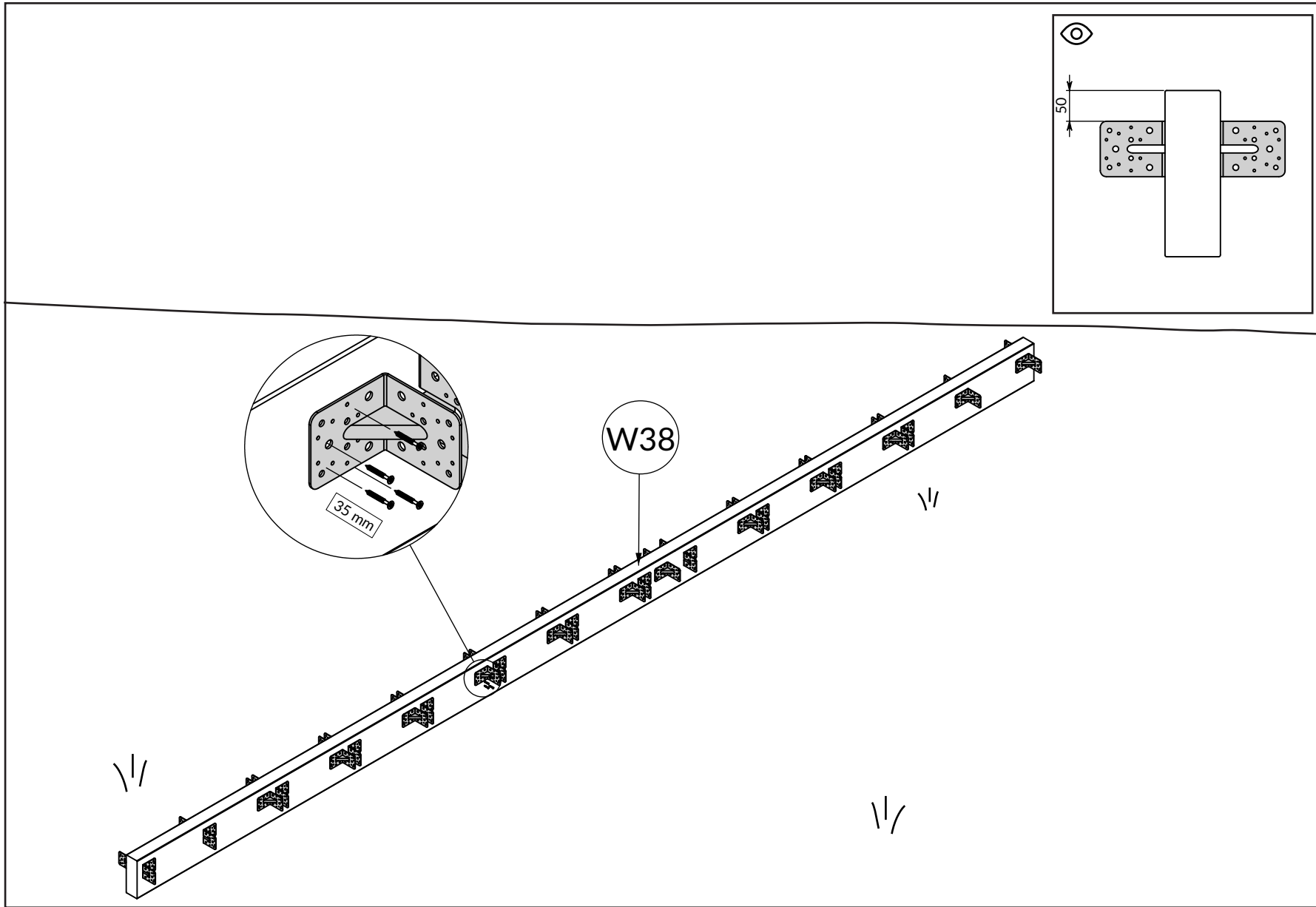

W38 x1

  
x48

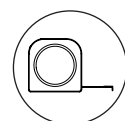

A|1→2→3→4→5→    B|1→2→3→4→5→6→7→8→9→10→11→12→13→14→15→16→17→18→19→20→  
 C|1→2→3→4→5→6→7→8→9→    D|1→2→3→4→5→6→7→8→    E|1→2→3→4→5→6→7→  
 F|1→2→3→4→5→    G|1→2→3→    H|1→2→3→    I|1→2→3→4→5→    J|1→2→3→4→

# D1

A|1→2→3→4→5→ B|1→2→3→4→5→6→7→8→9→10→11→12→13→14→15→16→17→18→19→20→  
 C|1→2→3→4→5→6→7→8→9→ D|1→2→3→4→5→6→7→8→ E|1→2→3→4→5→6→7→  
 F|1→2→3→4→5→ G|1→2→3→ H|1→2→3→ I|1→2→3→4→5→ J|1→2→3→4→

# D1.1

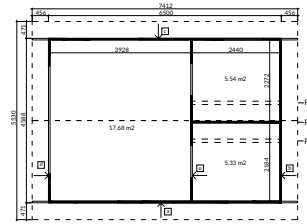

V-1

W38 x1



x48

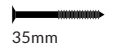

35mm

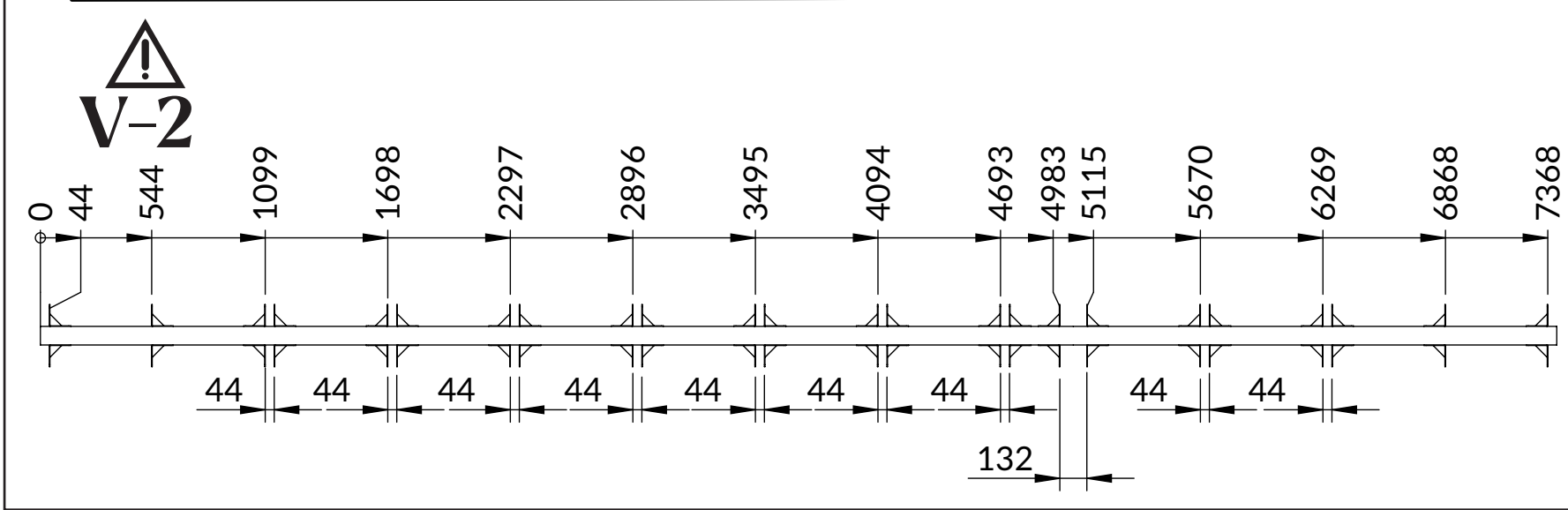
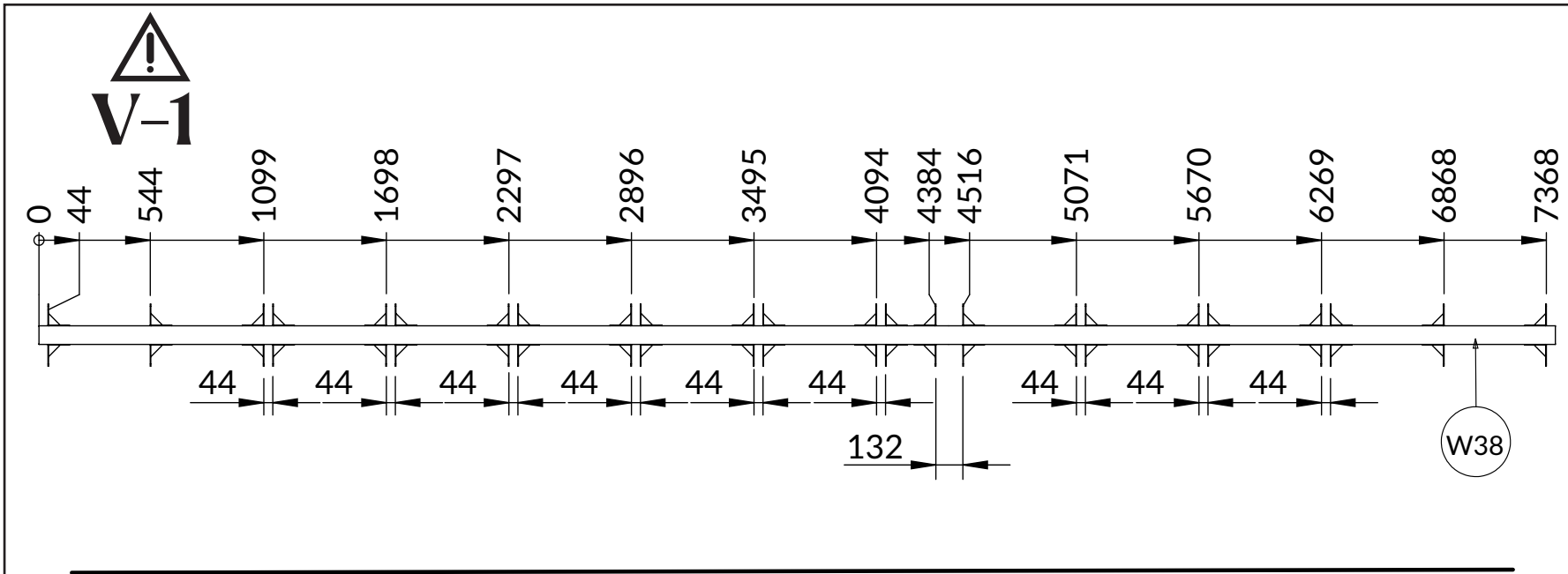
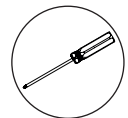
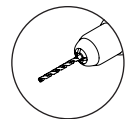
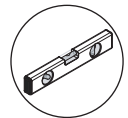

W38 x1

W38

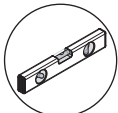
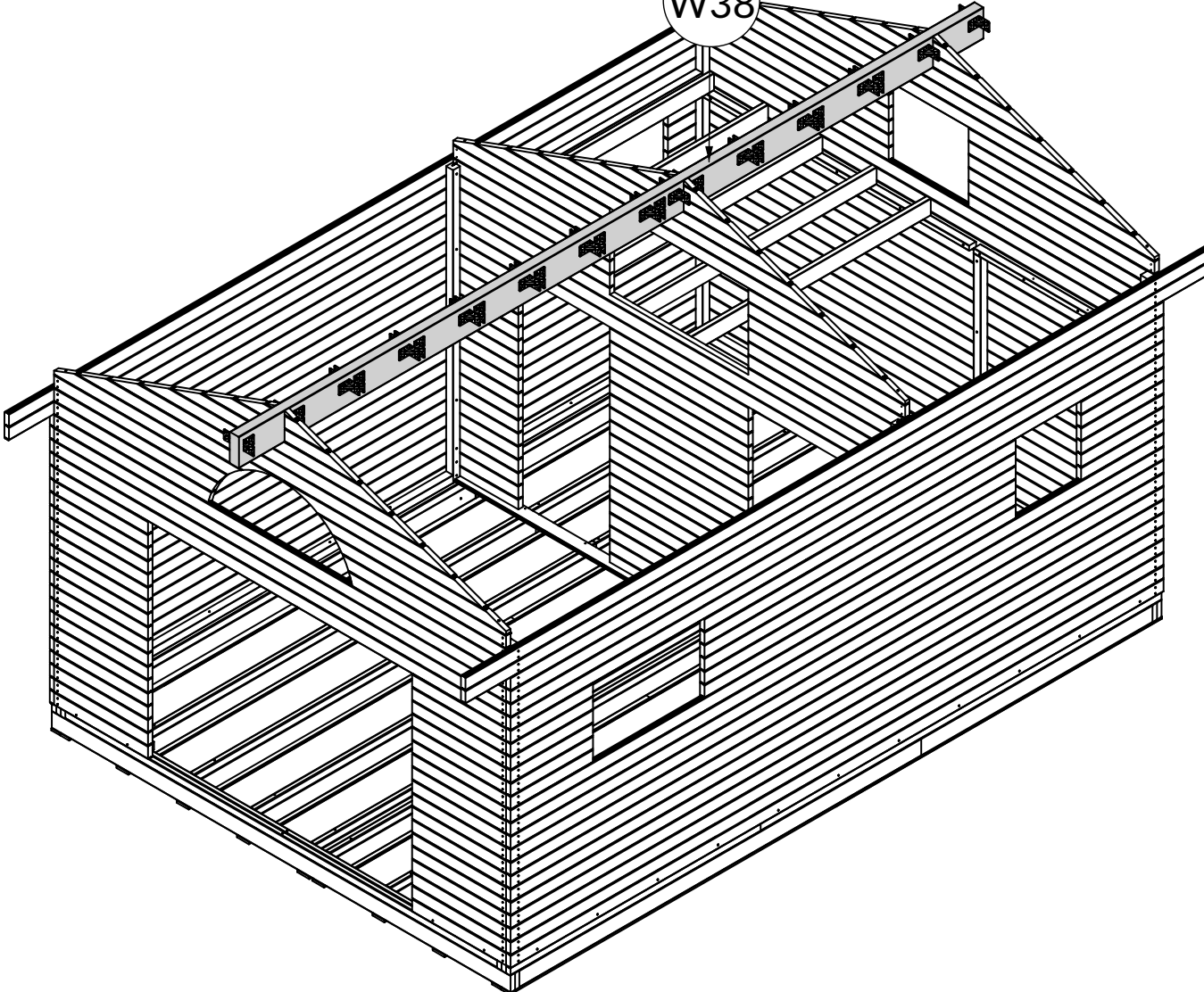

A|1→2→3→4→5→ B|1→2→3→4→5→6→7→8→9→10→11→12→13→14→15→16→17→18→19→20→  
C|1→2→3→4→5→6→7→8→9→ D|1→2→3→4→5→6→7→8→ E|1→2→3→4→5→6→7→  
F|1→2→3→4→5→ G|1→2→3→ H|1→2→3→ I|1→2→3→4→5→ J|1→2→3→4→

# D2

# D3

A | 1 → 2 → 3 → 4 → 5 →    B | 1 → 2 → 3 → 4 → 5 → 6 → 7 → 8 → 9 → 10 → 11 → 12 → 13 → 14 → 15 → 16 → 17 → 18 → 19 → 20 →  
C | 1 → 2 → 3 → 4 → 5 → 6 → 7 → 8 → 9 →    D | 1 → 2 → 3 → 4 → 5 → 6 → 7 → 8 →    E | 1 → 2 → 3 → 4 → 5 → 6 → 7 →  
F | 1 → 2 → 3 → 4 → 5 →    G | 1 → 2 → 3 →    H | 1 → 2 → 3 →    I | 1 → 2 → 3 → 4 → 5 →    J | 1 → 2 → 3 → 4 →

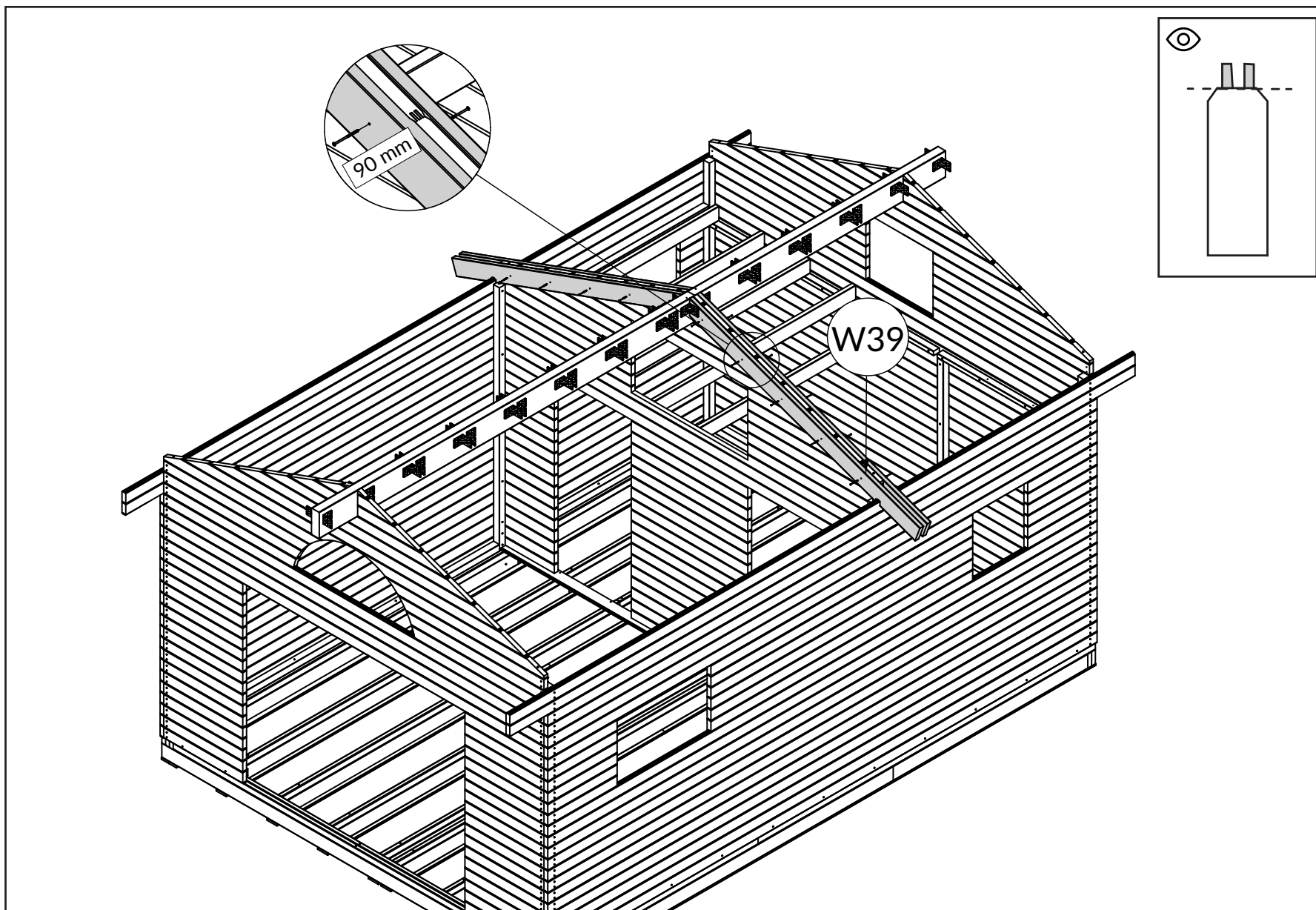

W39 x4

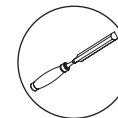
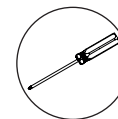
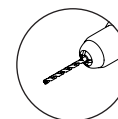
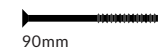

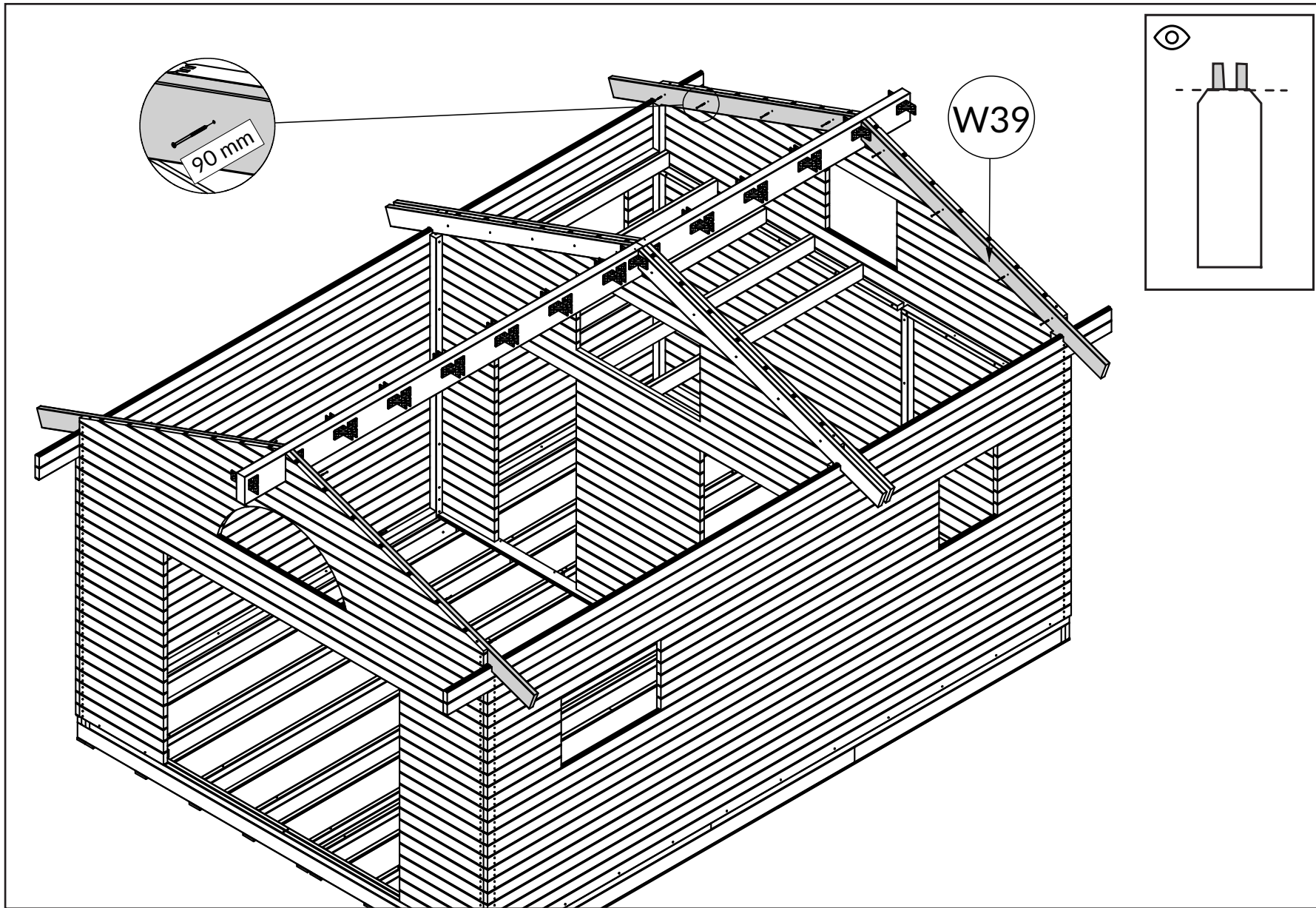

W39 x4

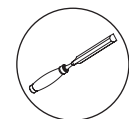
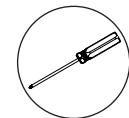
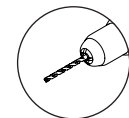
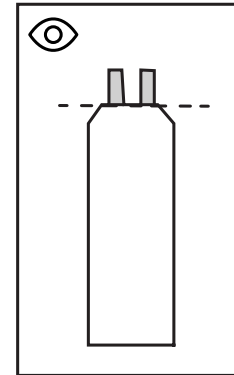

A|1→2→3→4→5→ B|1→2→3→4→5→6→7→8→9→10→11→12→13→14→15→16→17→18→19→20→  
 C|1→2→3→4→5→6→7→8→9→ D|1→2→3→4→5→6→7→8→ E|1→2→3→4→5→6→7→  
 F|1→2→3→4→5→ G|1→2→3→ H|1→2→3→ I|1→2→3→4→5→ J|1→2→3→4→

# D4

# D5

A|1→2→3→4→5→ B|1→2→3→4→5→6→7→8→9→10→11→12→13→14→15→16→17→18→19→20→  
C|1→2→3→4→5→6→7→8→9→ D|1→2→3→4→5→6→7→8→ E|1→2→3→4→5→6→7→  
F|1→2→3→4→5→ G|1→2→3→ H|1→2→3→ I|1→2→3→4→5→ J|1→2→3→4→

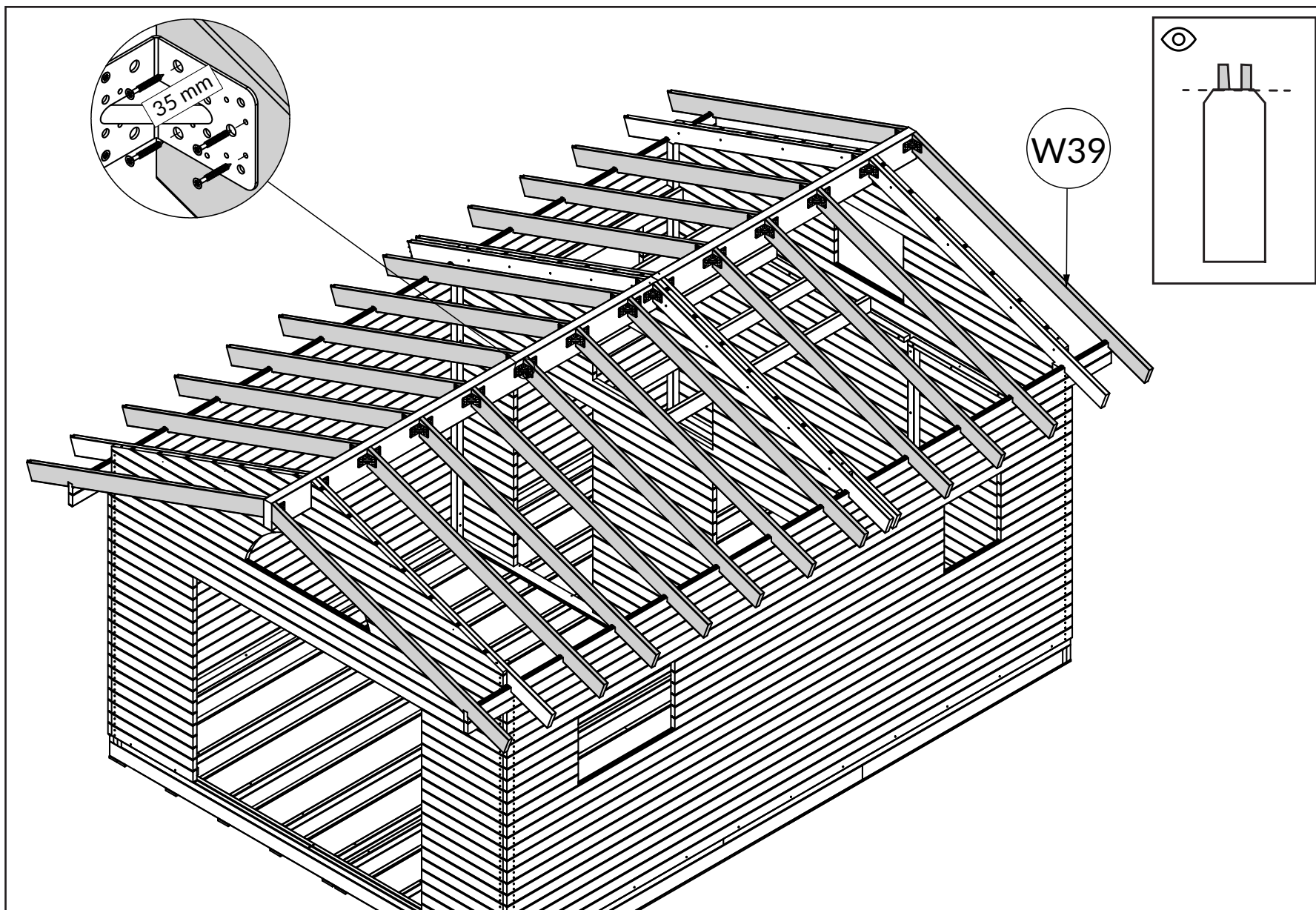

W39 x22

W39

35mm

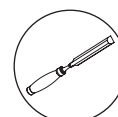
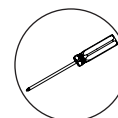
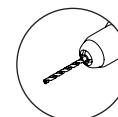

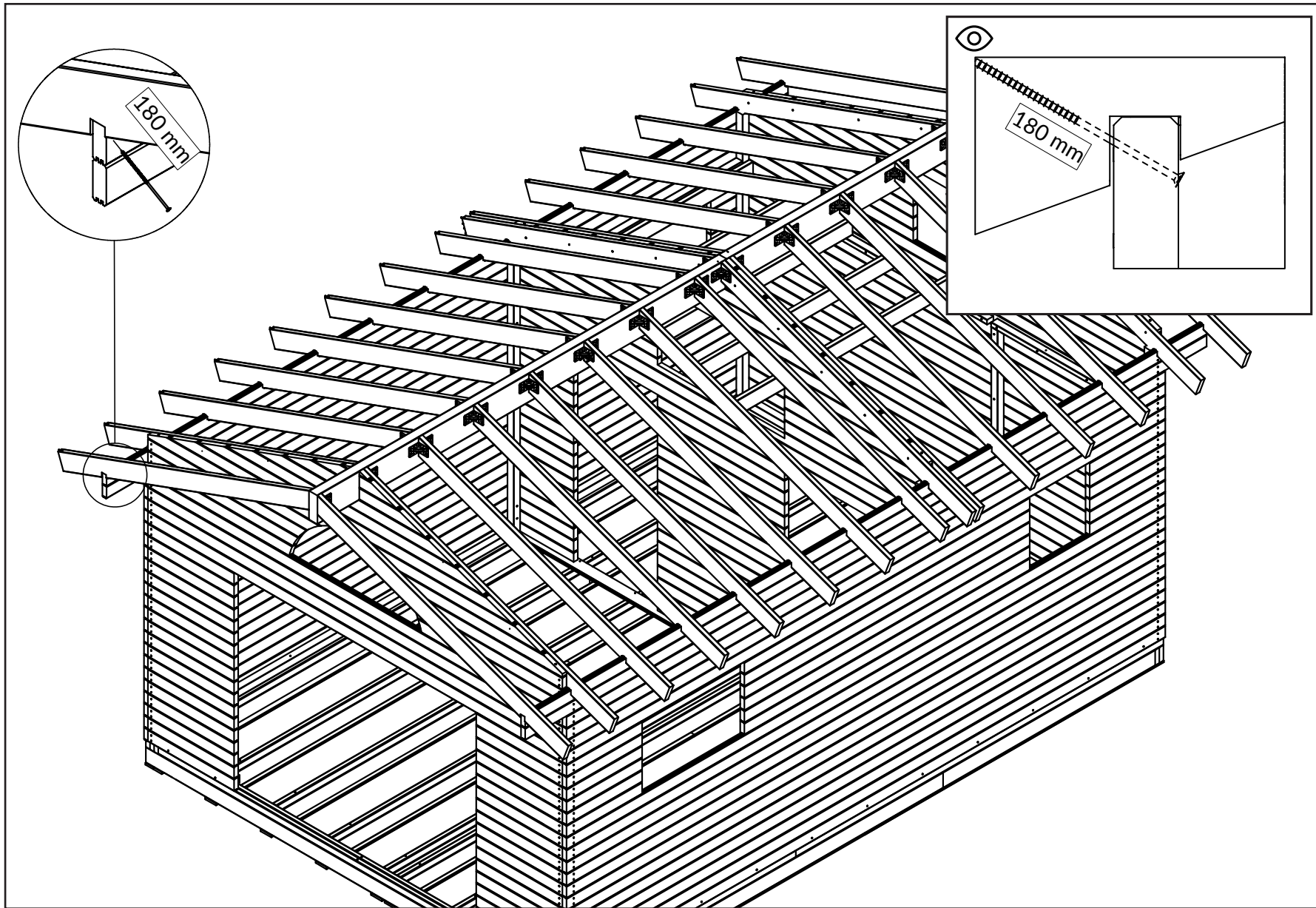

A|1→2→3→4→5→ B|1→2→3→4→5→6→7→8→9→10→11→12→13→14→15→16→17→18→19→20→  
 C|1→2→3→4→5→6→7→8→9→ D|1→2→3→4→5→6→7→8→ E|1→2→3→4→5→6→7→  
 F|1→2→3→4→5→ G|1→2→3→ H|1→2→3→ I|1→2→3→4→5→ J|1→2→3→4→

# D6

A|1→2→3→4→5→ B|1→2→3→4→5→6→7→8→9→10→11→12→13→14→15→16→17→18→19→20→  
C|1→2→3→4→5→6→7→8→9→ D|1→2→3→4→5→6→7→8→ E|1→2→3→4→5→6→7→  
F|1→2→3→4→5→ G|1→2→3→ H|1→2→3→ I|1→2→3→4→5→ J|1→2→3→4→

# D7

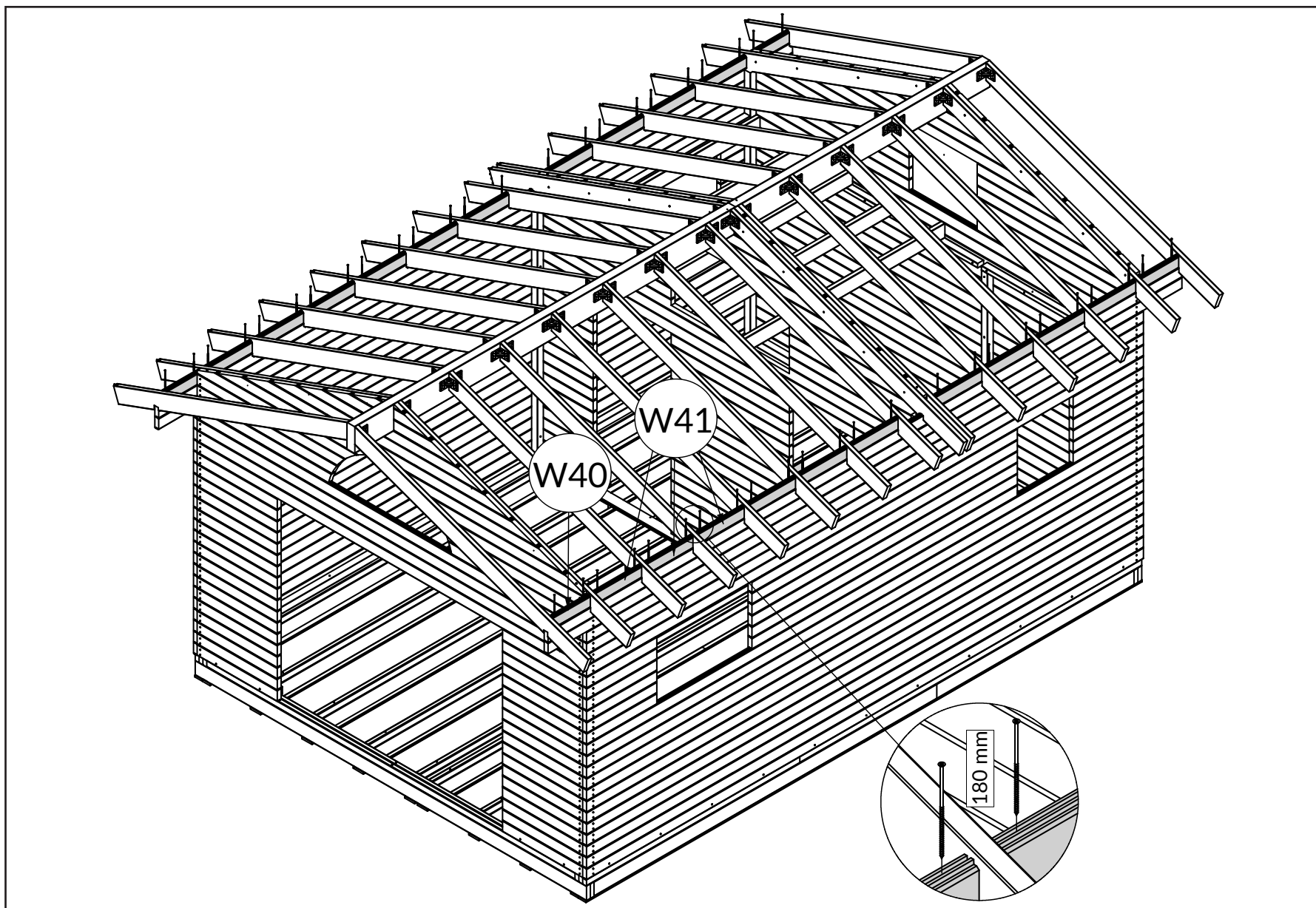

W40 x4

W41 x20

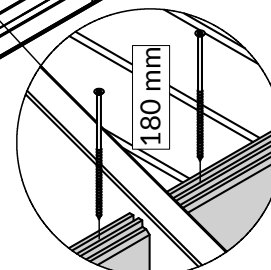
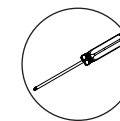
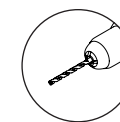
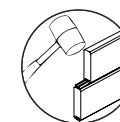

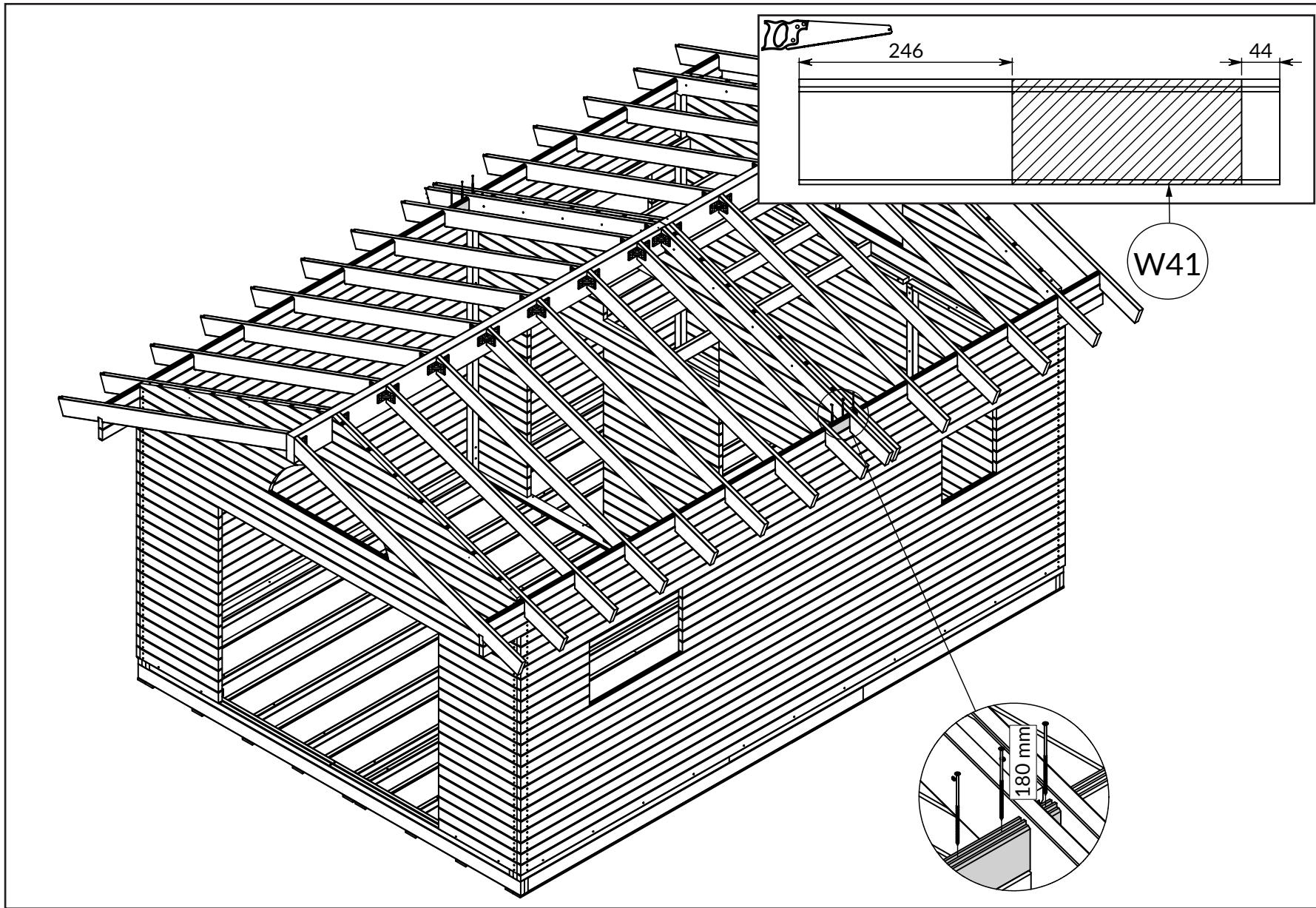

W41 x2

W41



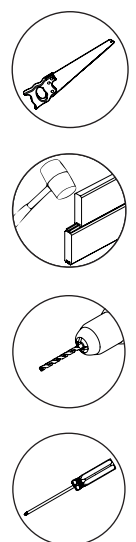

180mm

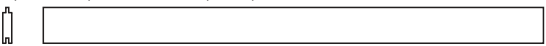
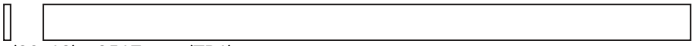

A|1→2→3→4→5→ B|1→2→3→4→5→6→7→8→9→10→11→12→13→14→15→16→17→18→19→20→  
 C|1→2→3→4→5→6→7→8→9→ D|1→2→3→4→5→6→7→8→ E|1→2→3→4→5→6→7→  
 F|1→2→3→4→5→ G|1→2→3→ H|1→2→3→ I|1→2→3→4→5→ J|1→2→3→4→

# D8

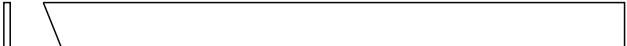
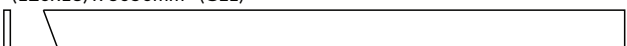
## E

- W42  
x66   
(90x18.5) x 5093mm (RB-1)
- W43  
x66   
(90x18.5) x 2319mm (RB-2)
- W44  
x4   
(90x18) x 3517mm (TB1)
- W45  
x4   
(90x18) x 3895mm (TB2)
- W46  
x8   
(120x18) x 3050mm (GL1)
- W47  
x4   
(140x18) x 3050mm (GL2)
- W48  
x4   
(58x18) x 3050mm (RFF)

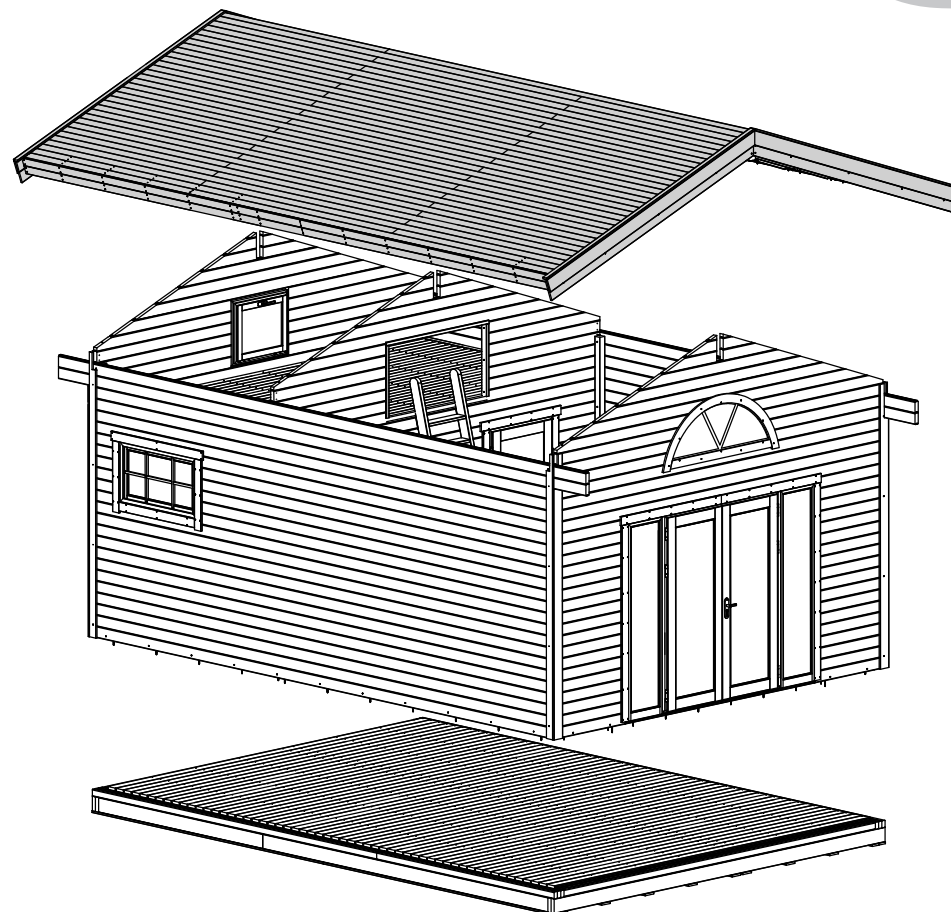
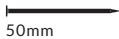
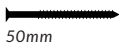

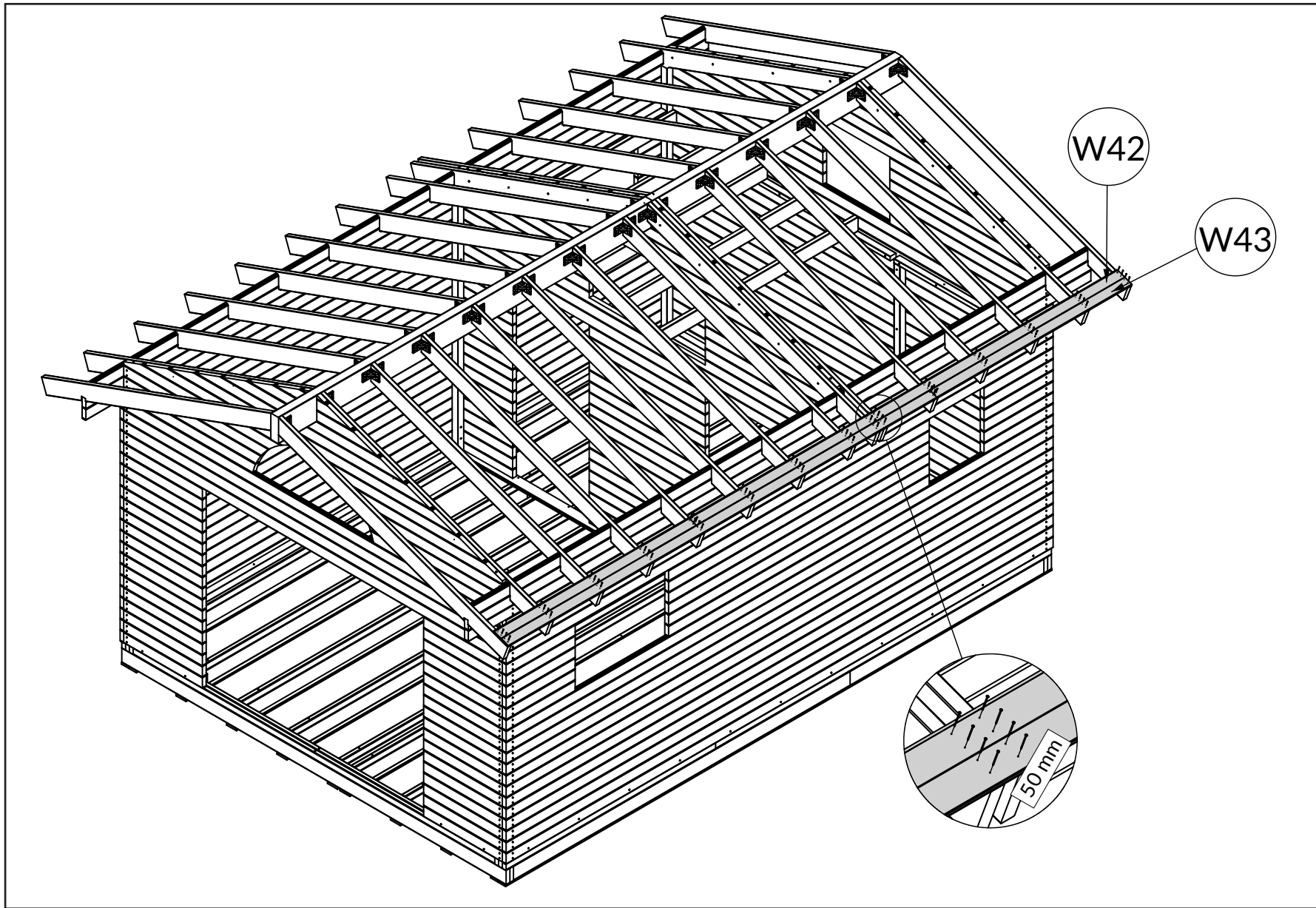

W42 x2

W43 x2

W42

W43

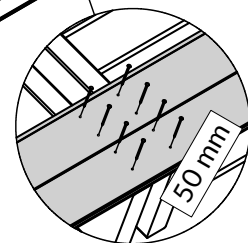

50mm

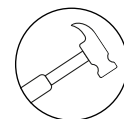

A|1→2→3→4→5→ B|1→2→3→4→5→6→7→8→9→10→11→12→13→14→15→16→17→18→19→20→  
 C|1→2→3→4→5→6→7→8→9→ D|1→2→3→4→5→6→7→8→ E|1→2→3→4→5→6→7→  
 F|1→2→3→4→5→ G|1→2→3→ H|1→2→3→ I|1→2→3→4→5→ J|1→2→3→4→

**E1**

A|1→2→3→4→5→ B|1→2→3→4→5→6→7→8→9→10→11→12→13→14→15→16→17→18→19→20→  
C|1→2→3→4→5→6→7→8→9→ D|1→2→3→4→5→6→7→8→ E|1→2→3→4→5→6→7→  
F|1→2→3→4→5→ G|1→2→3→ H|1→2→3→ I|1→2→3→4→5→ J|1→2→3→4→

# E2

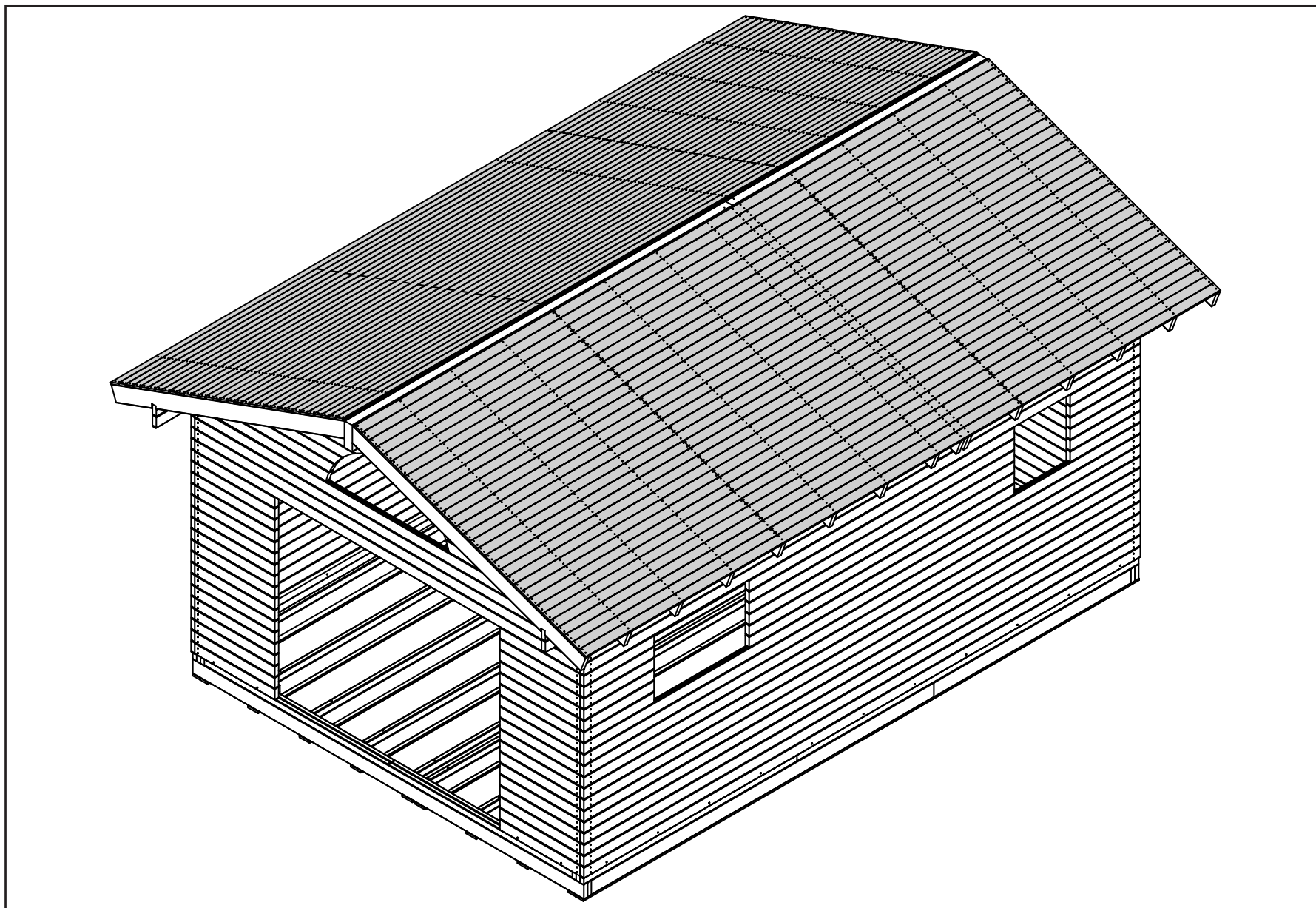

W42 x63

W43 x63

50mm



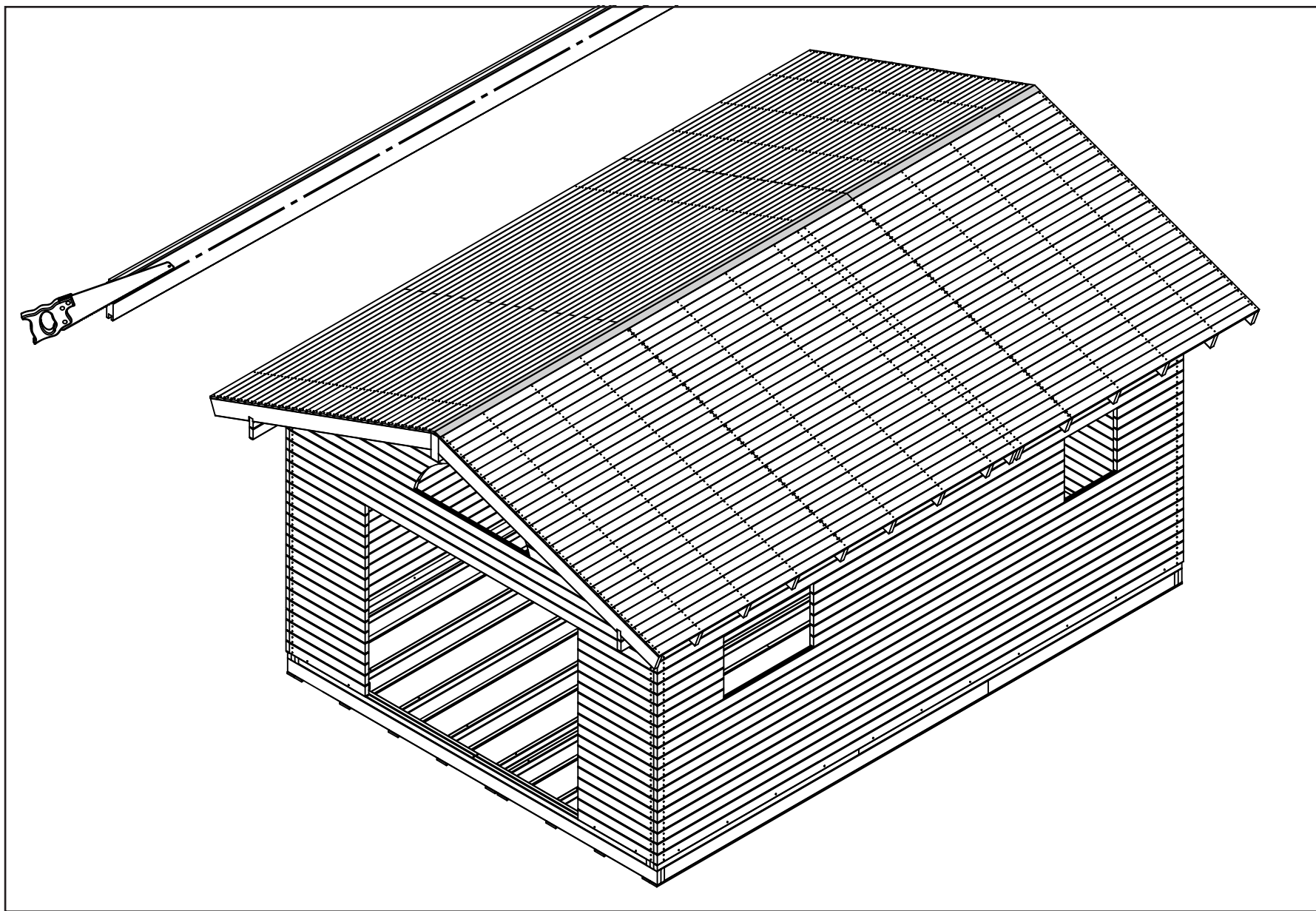

W42 x1

W43 x1

50mm

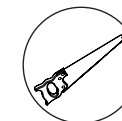

A|1→2→3→4→5→ B|1→2→3→4→5→6→7→8→9→10→11→12→13→14→15→16→17→18→19→20→  
 C|1→2→3→4→5→6→7→8→9→ D|1→2→3→4→5→6→7→8→ E|1→2→3→4→5→6→7→  
 F|1→2→3→4→5→ G|1→2→3→ H|1→2→3→ I|1→2→3→4→5→ J|1→2→3→4→

**E3**

A|1→2→3→4→5→ B|1→2→3→4→5→6→7→8→9→10→11→12→13→14→15→16→17→18→19→20→  
C|1→2→3→4→5→6→7→8→9→ D|1→2→3→4→5→6→7→8→ E|1→2→3→4→5→6→7→  
F|1→2→3→4→5→ G|1→2→3→ H|1→2→3→ I|1→2→3→4→5→ J|1→2→3→4→

# E4

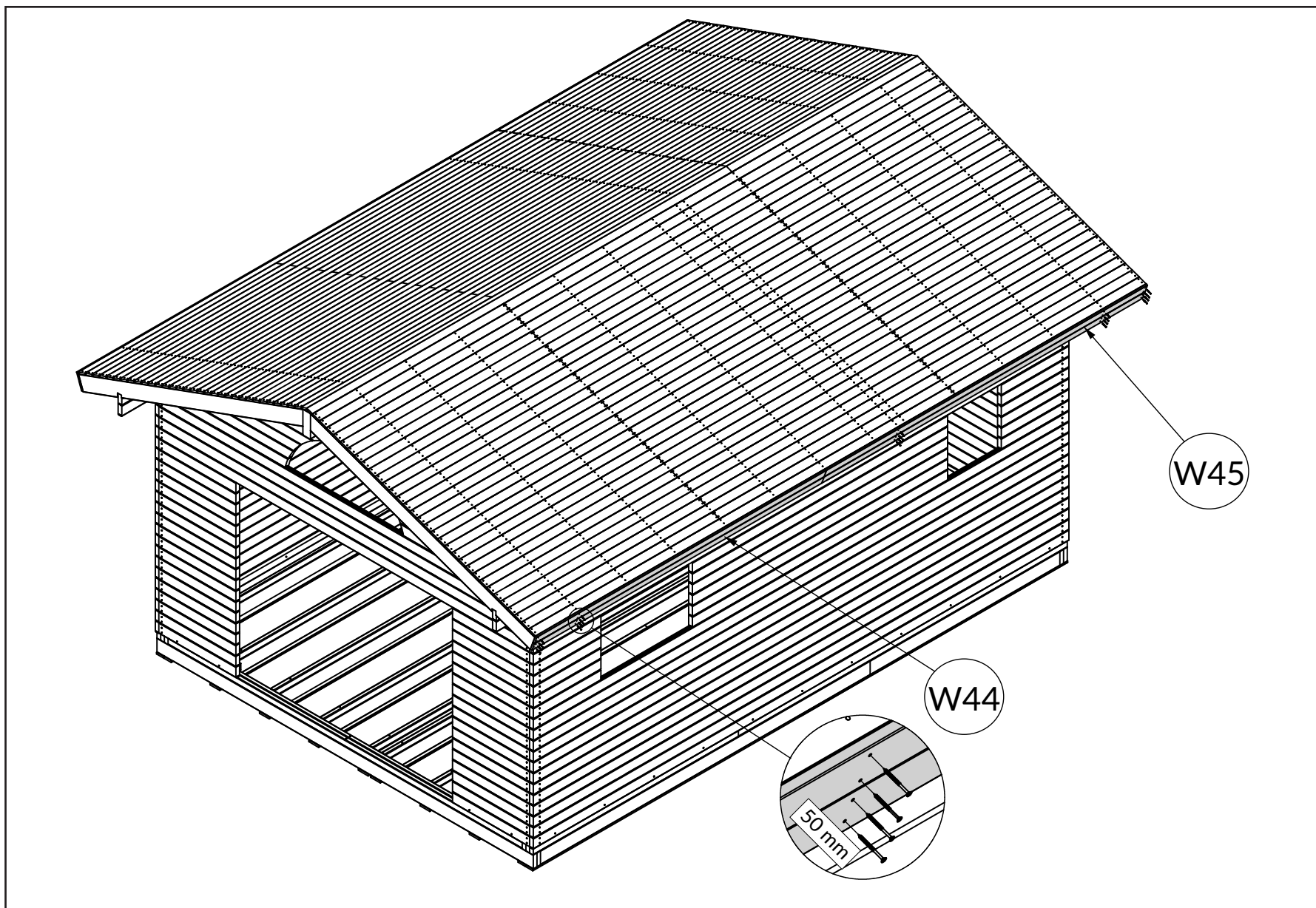

W44 x4

W45 x4

W45

W44

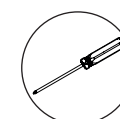
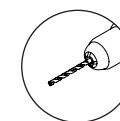
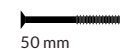

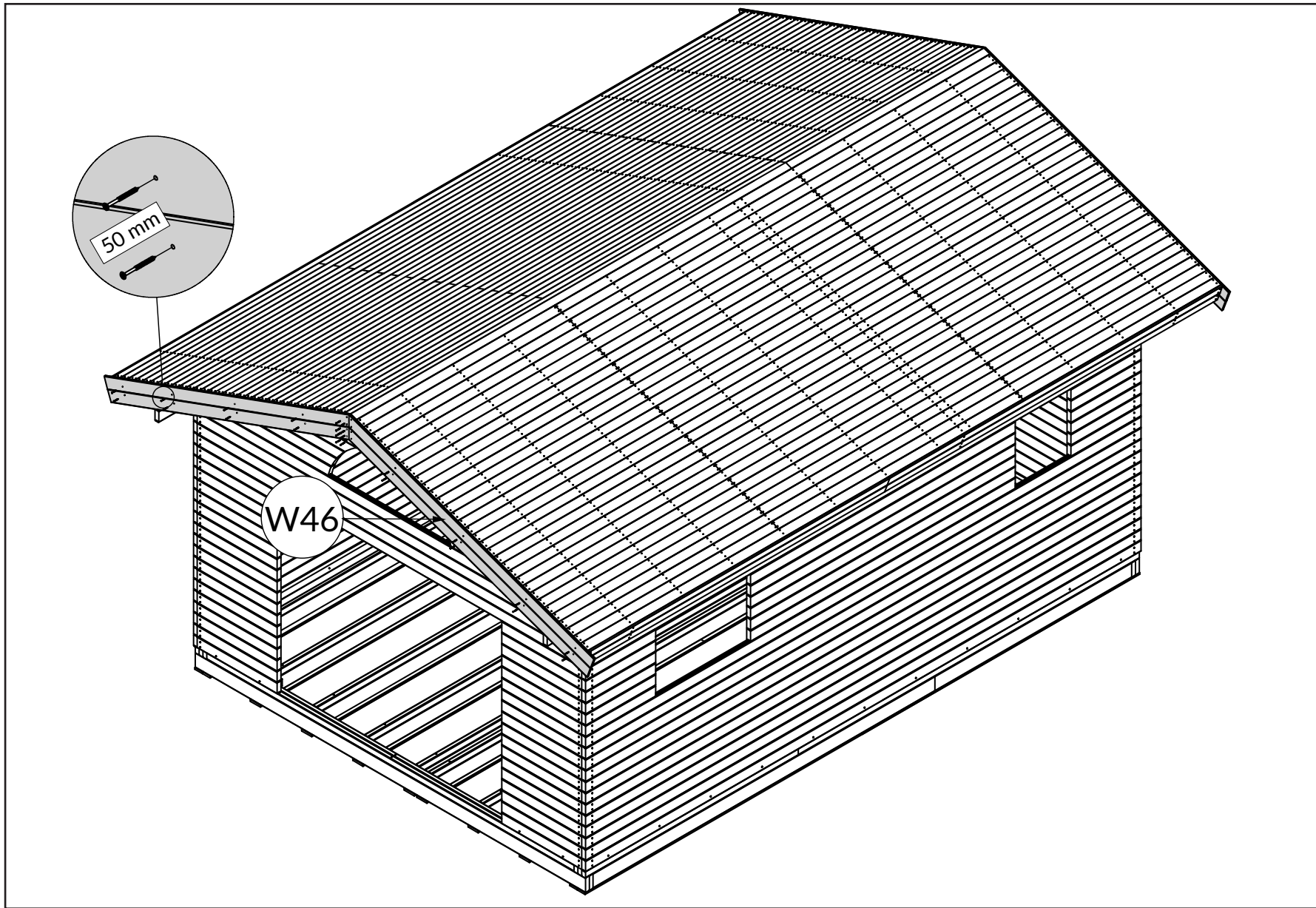

W46 x8

50 mm

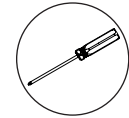
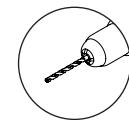

A|1→2→3→4→5→ B|1→2→3→4→5→6→7→8→9→10→11→12→13→14→15→16→17→18→19→20→  
 C|1→2→3→4→5→6→7→8→9→ D|1→2→3→4→5→6→7→8→ E|1→2→3→4→5→6→7→  
 F|1→2→3→4→5→ G|1→2→3→ H|1→2→3→ I|1→2→3→4→5→ J|1→2→3→4→

# E5

A|1→2→3→4→5→ B|1→2→3→4→5→6→7→8→9→10→11→12→13→14→15→16→17→18→19→20→  
C|1→2→3→4→5→6→7→8→9→ D|1→2→3→4→5→6→7→8→ E|1→2→3→4→5→6→7→  
F|1→2→3→4→5→ G|1→2→3→ H|1→2→3→ I|1→2→3→4→5→ J|1→2→3→4→

# E6

W47 x4

W47

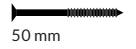
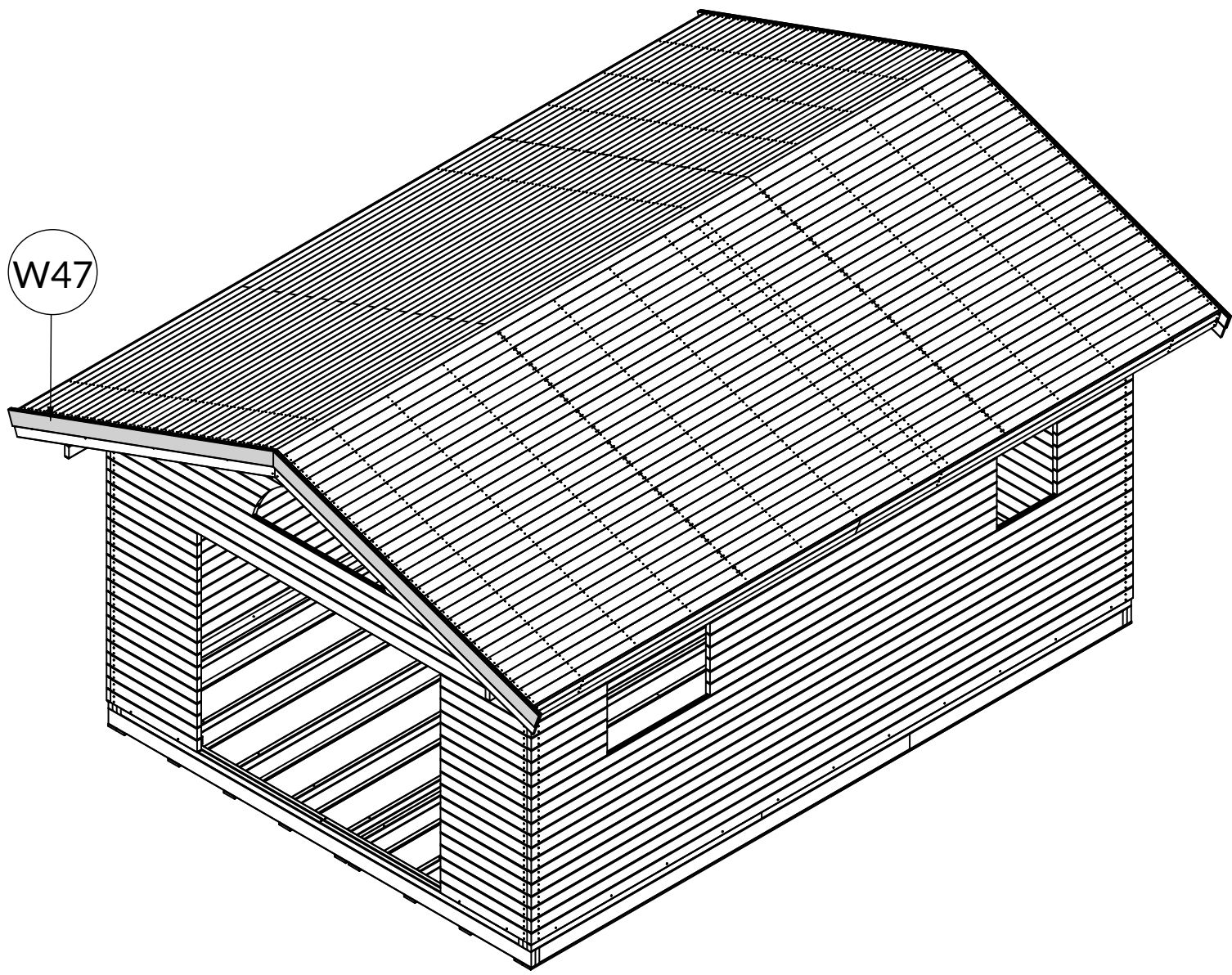

50 mm

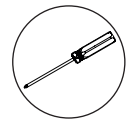
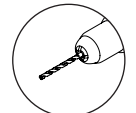

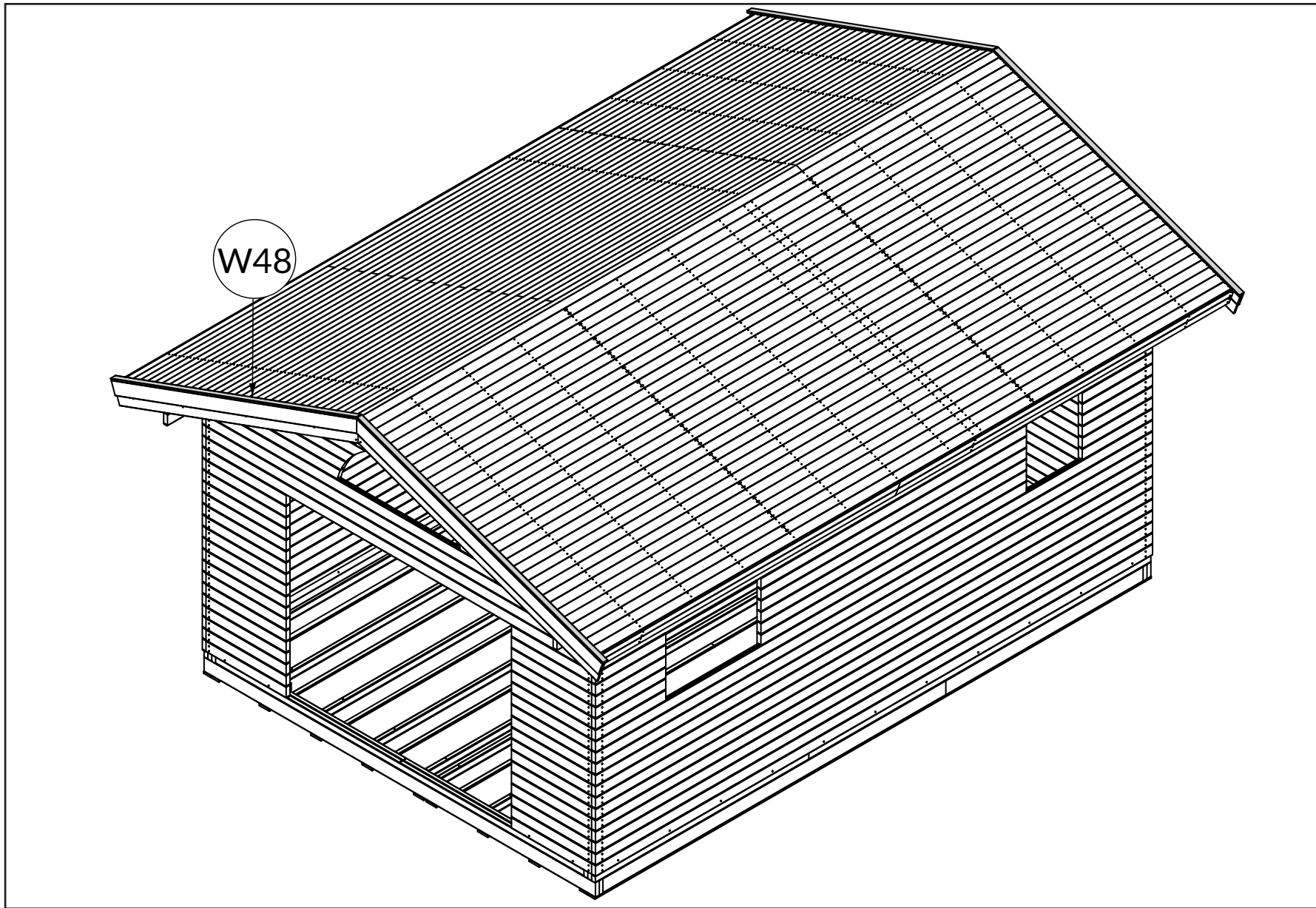

W48 x4

W48

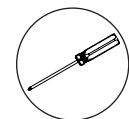
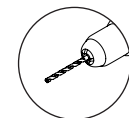
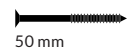

A|1→2→3→4→5→ B|1→2→3→4→5→6→7→8→9→10→11→12→13→14→15→16→17→18→19→20→  
 C|1→2→3→4→5→6→7→8→9→ D|1→2→3→4→5→6→7→8→ E|1→2→3→4→5→6→7→  
 F|1→2→3→4→5→ G|1→2→3→ H|1→2→3→ I|1→2→3→4→5→ J|1→2→3→4→

# E7

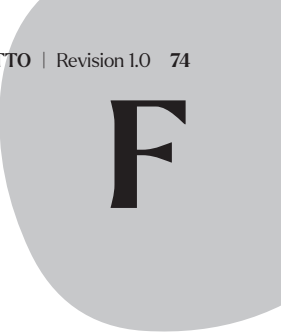

F

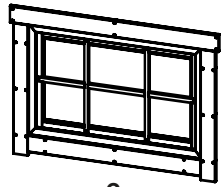

x2

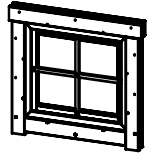

x1

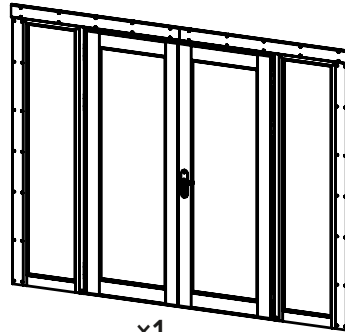

x1

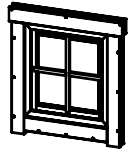

x1

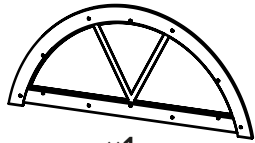

x1

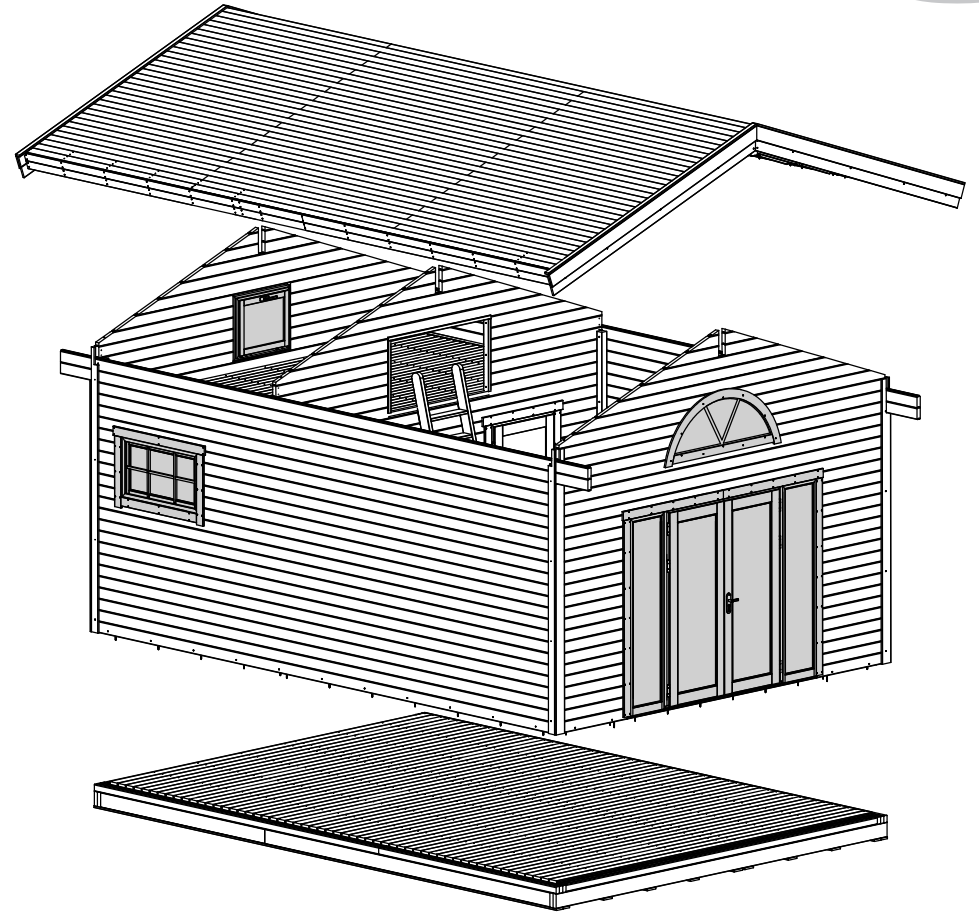

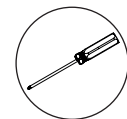
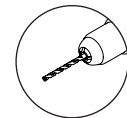
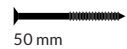
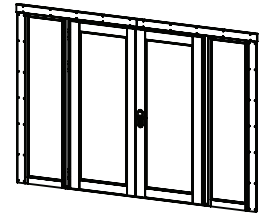
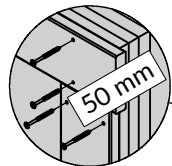
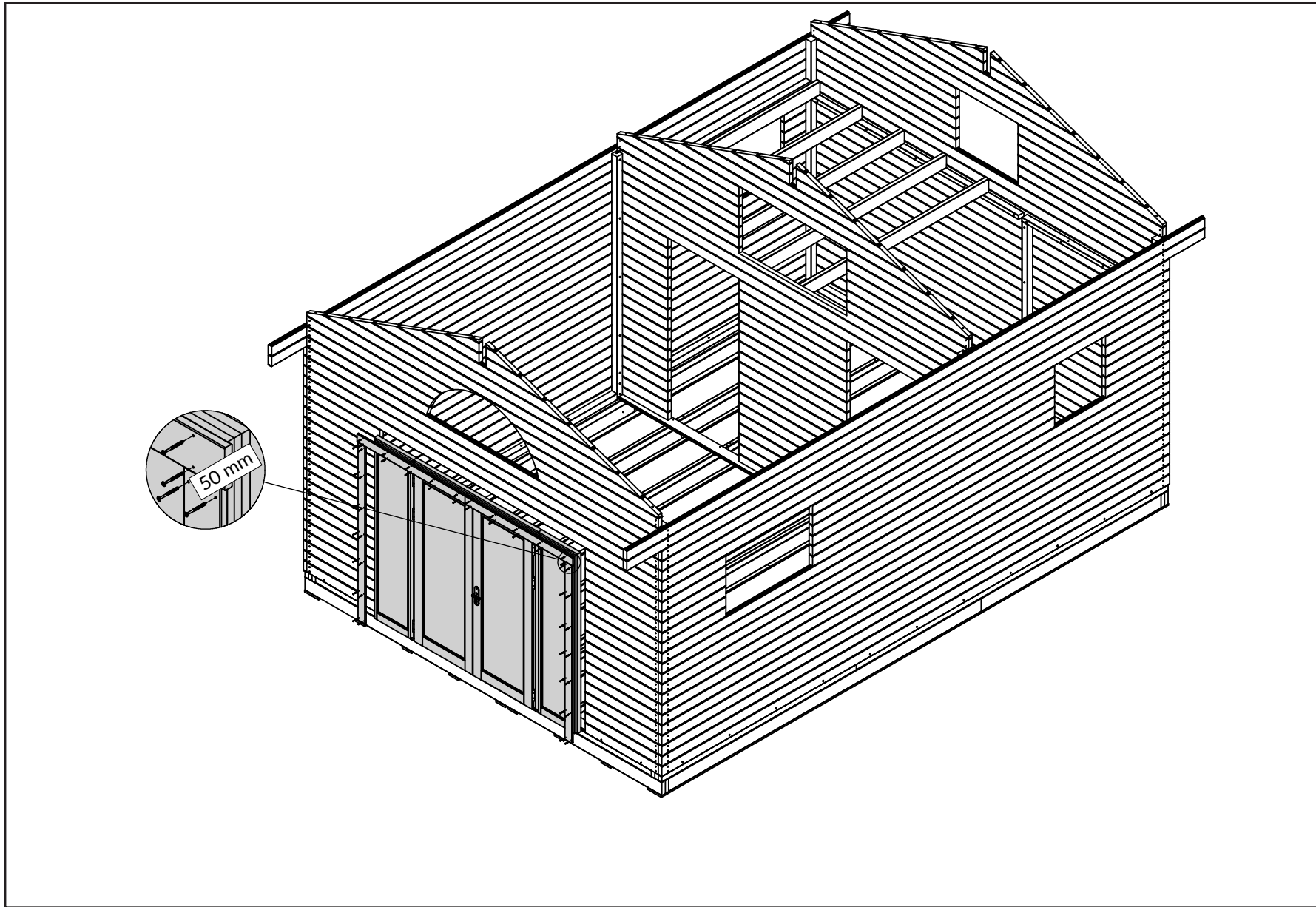

**A** | 1 → 2 → 3 → 4 → 5 →    **B** | 1 → 2 → 3 → 4 → 5 → 6 → 7 → 8 → 9 → 10 → 11 → 12 → 13 → 14 → 15 → 16 → 17 → 18 → 19 → 20 →  
**C** | 1 → 2 → 3 → 4 → 5 → 6 → 7 → 8 → 9 →    **D** | 1 → 2 → 3 → 4 → 5 → 6 → 7 → 8 →    **E** | 1 → 2 → 3 → 4 → 5 → 6 → 7 →  
**F** | 1 → 2 → 3 → 4 → 5 →    **G** | 1 → 2 → 3 →    **H** | 1 → 2 → 3 →    **I** | 1 → 2 → 3 → 4 → 5 →    **J** | 1 → 2 → 3 → 4 →

# F1

A|1→2→3→4→5→ B|1→2→3→4→5→6→7→8→9→10→11→12→13→14→15→16→17→18→19→20→  
C|1→2→3→4→5→6→7→8→9→ D|1→2→3→4→5→6→7→8→ E|1→2→3→4→5→6→7→  
F|1→2→3→4→5→ G|1→2→3→ H|1→2→3→ I|1→2→3→4→5→ J|1→2→3→4→

# F2

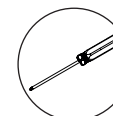
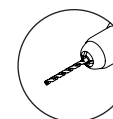
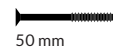
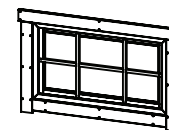
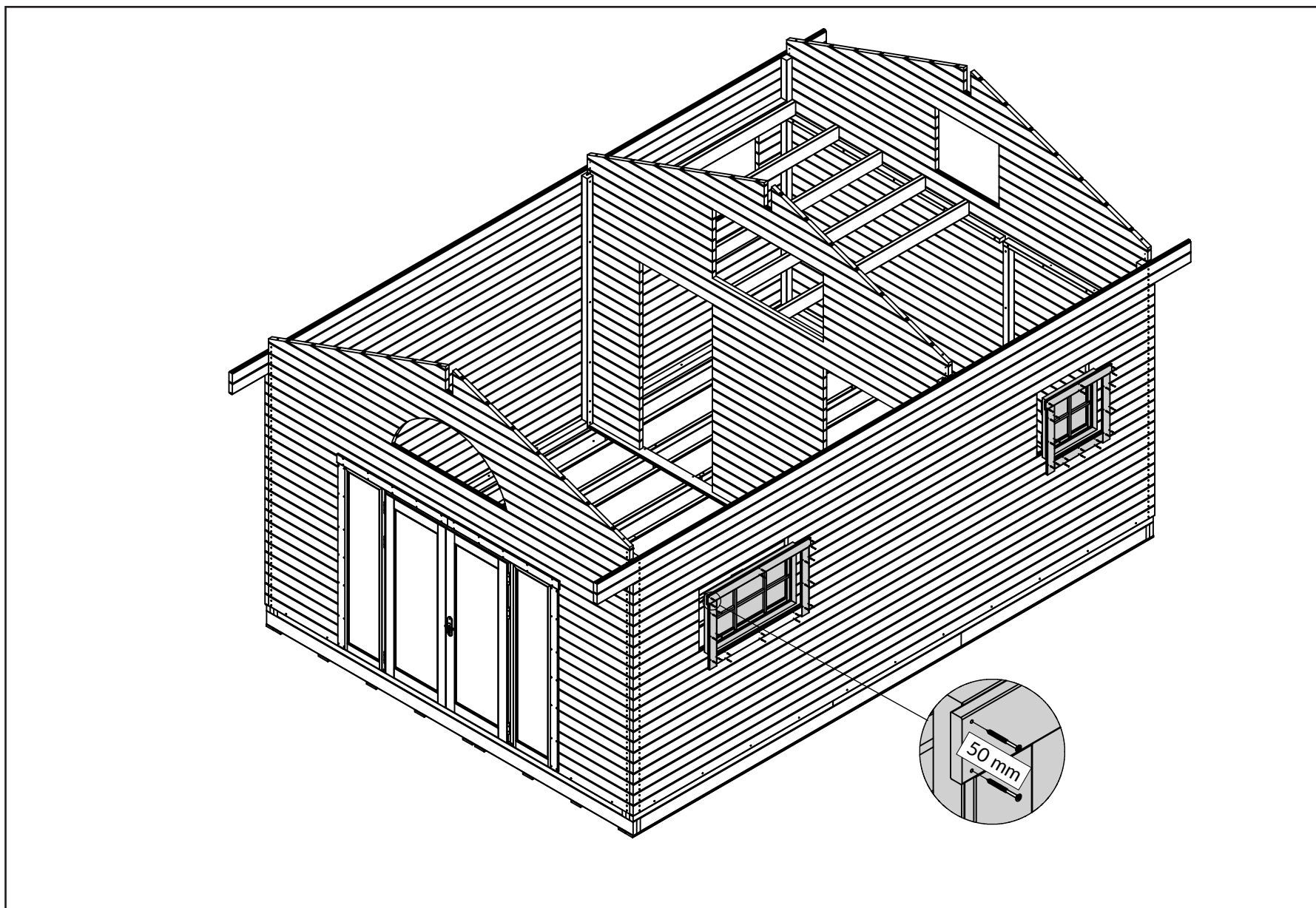

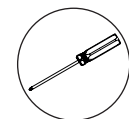
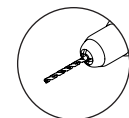
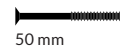
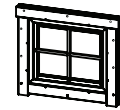
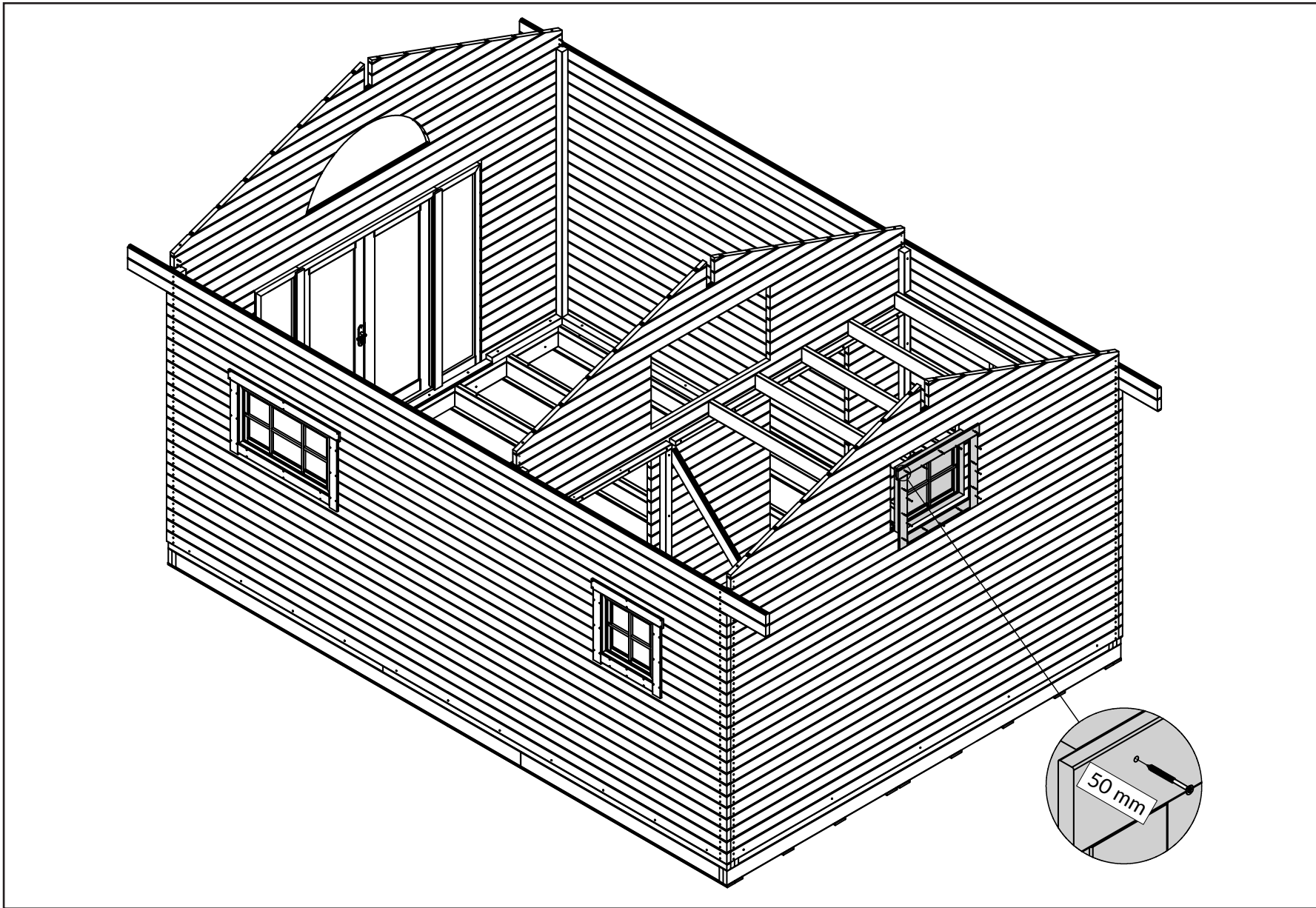

**A** | 1 → 2 → 3 → 4 → 5 →   
**B** | 1 → 2 → 3 → 4 → 5 → 6 → 7 → 8 → 9 → 10 → 11 → 12 → 13 → 14 → 15 → 16 → 17 → 18 → 19 → 20 →  
**C** | 1 → 2 → 3 → 4 → 5 → 6 → 7 → 8 → 9 →   
**D** | 1 → 2 → 3 → 4 → 5 → 6 → 7 → 8 →   
**E** | 1 → 2 → 3 → 4 → 5 → 6 → 7 →  
**F** | 1 → 2 → 3 → 4 → 5 →   
**G** | 1 → 2 → 3 →   
**H** | 1 → 2 → 3 →   
**I** | 1 → 2 → 3 → 4 → 5 →   
**J** | 1 → 2 → 3 → 4 →

# F3

A|1→2→3→4→5→ B|1→2→3→4→5→6→7→8→9→10→11→12→13→14→15→16→17→18→19→20→  
C|1→2→3→4→5→6→7→8→9→ D|1→2→3→4→5→6→7→8→ E|1→2→3→4→5→6→7→  
F|1→2→3→4→5→ G|1→2→3→ H|1→2→3→ I|1→2→3→4→5→ J|1→2→3→4→

# F4

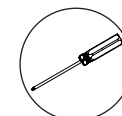
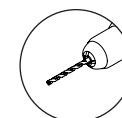
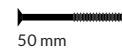
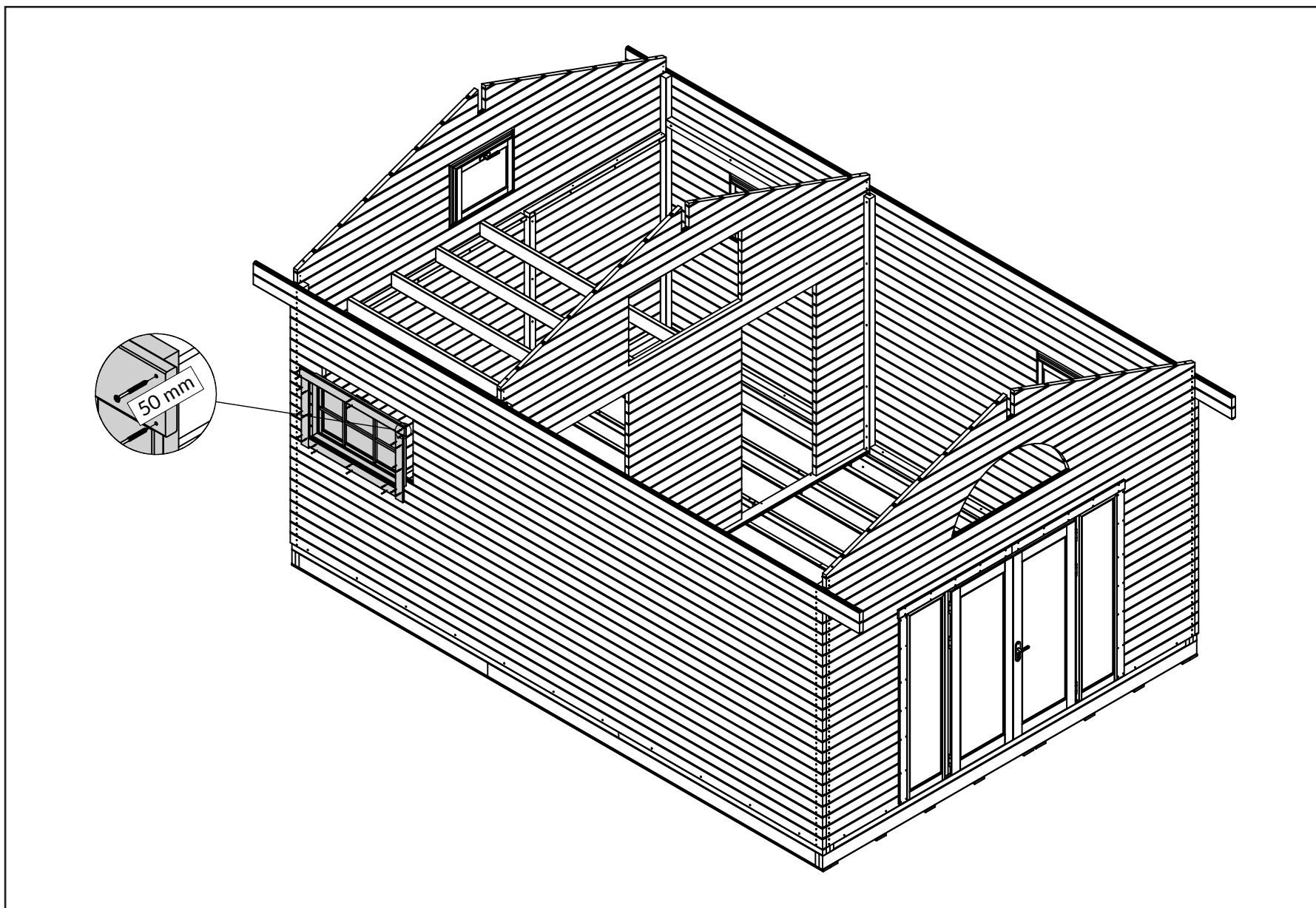
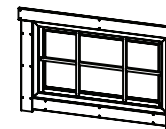

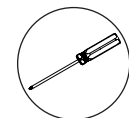
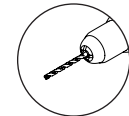
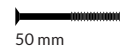
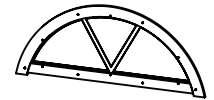
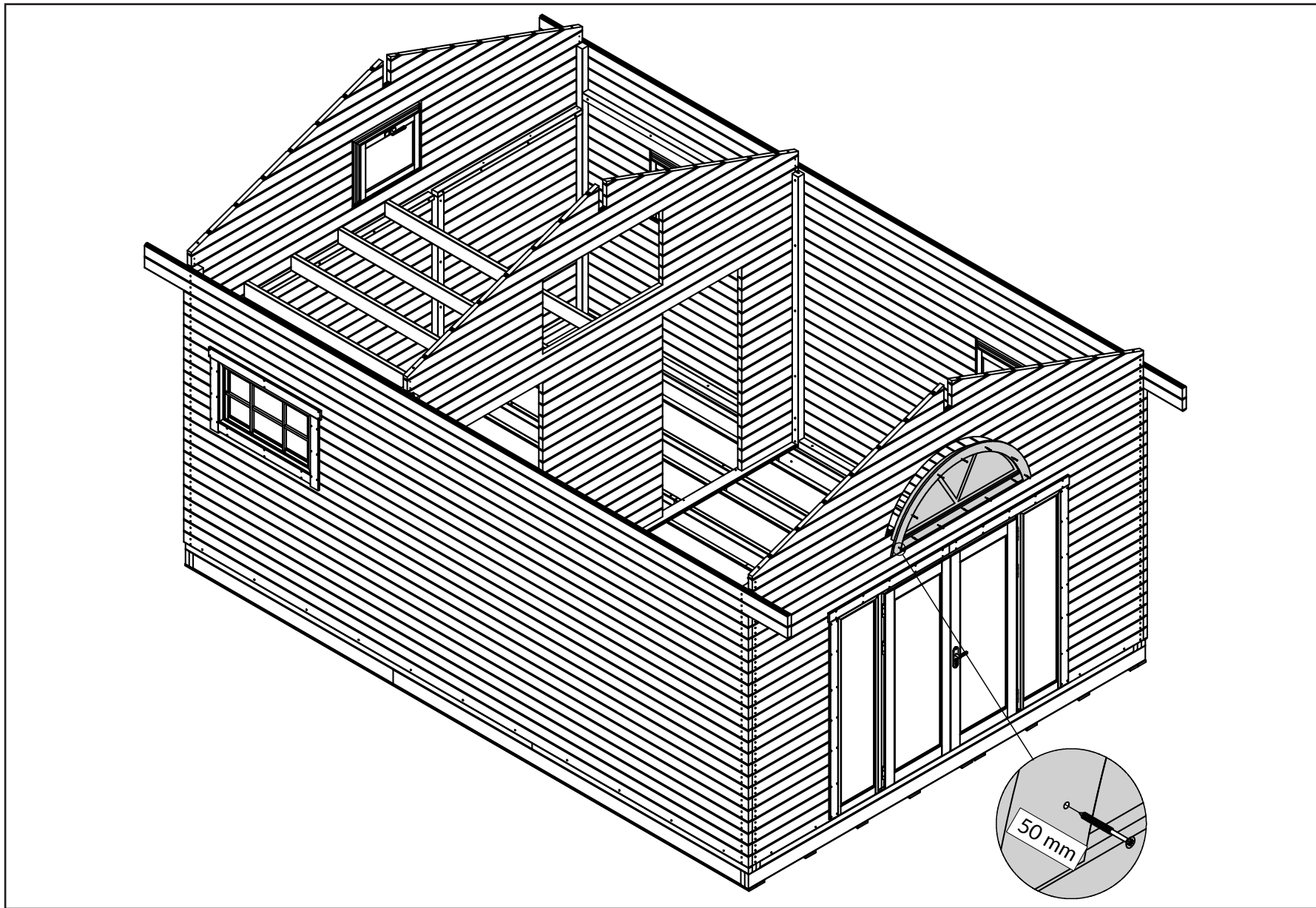

**A** | 1 → 2 → 3 → 4 → 5 →    **B** | 1 → 2 → 3 → 4 → 5 → 6 → 7 → 8 → 9 → 10 → 11 → 12 → 13 → 14 → 15 → 16 → 17 → 18 → 19 → 20 →  
**C** | 1 → 2 → 3 → 4 → 5 → 6 → 7 → 8 → 9 →    **D** | 1 → 2 → 3 → 4 → 5 → 6 → 7 → 8 →    **E** | 1 → 2 → 3 → 4 → 5 → 6 → 7 →  
**F** | 1 → 2 → 3 → 4 → 5 →    **G** | 1 → 2 → 3 →    **H** | 1 → 2 → 3 →    **I** | 1 → 2 → 3 → 4 → 5 →    **J** | 1 → 2 → 3 → 4 →

# F5

# G

# G

W32  
x57

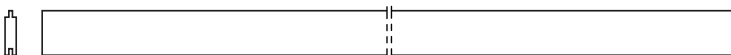

(112x28) x 4360mm (HLL-1)



40 mm

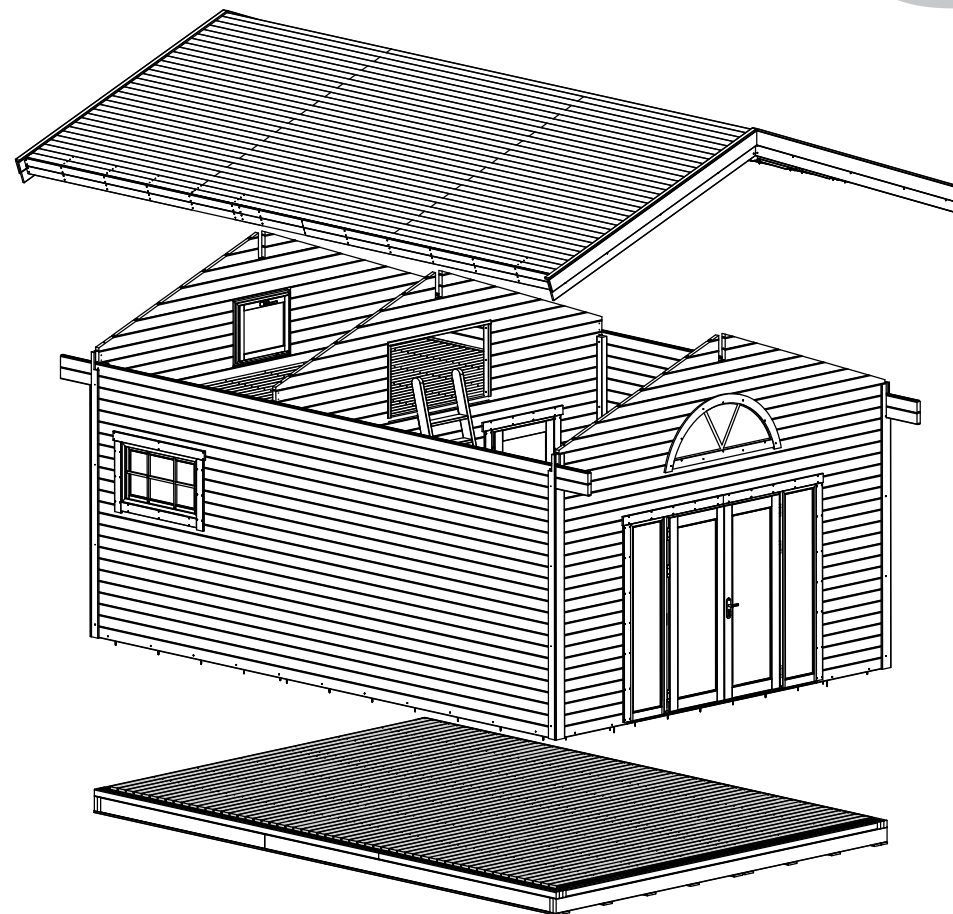

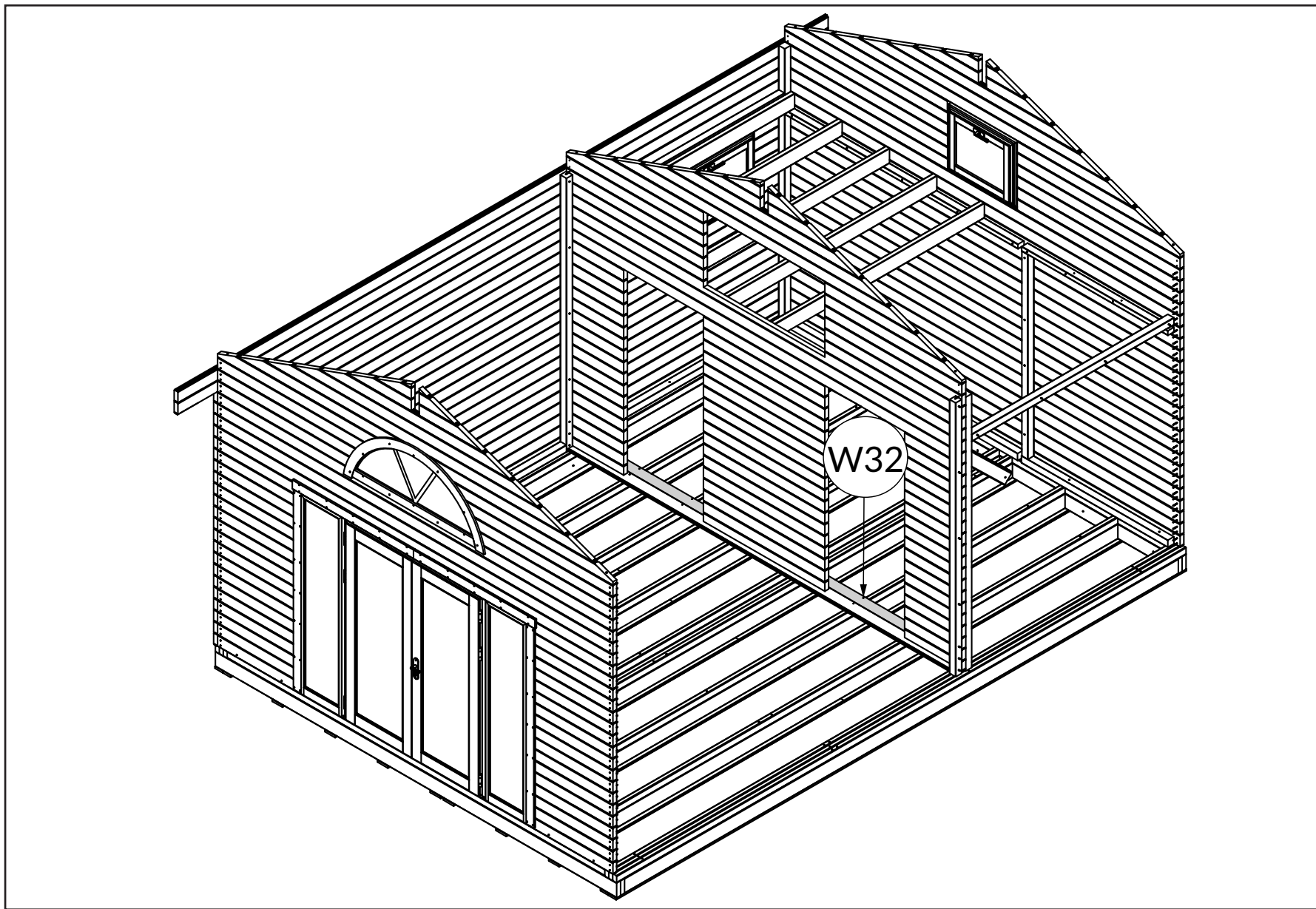

W32 x1

W32

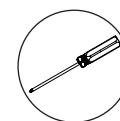
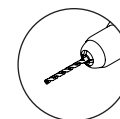
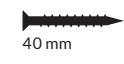

A|1→2→3→4→5→ B|1→2→3→4→5→6→7→8→9→10→11→12→13→14→15→16→17→18→19→20→  
 C|1→2→3→4→5→6→7→8→9→ D|1→2→3→4→5→6→7→8→ E|1→2→3→4→5→6→7→  
 F|1→2→3→4→5→ G|1→2→3→ H|1→2→3→ I|1→2→3→4→5→ J|1→2→3→4→

# G1

A|1→2→3→4→5→ B|1→2→3→4→5→6→7→8→9→10→11→12→13→14→15→16→17→18→19→20→  
C|1→2→3→4→5→6→7→8→9→ D|1→2→3→4→5→6→7→8→ E|1→2→3→4→5→6→7→  
F|1→2→3→4→5→ G|1→2→3→ H|1→2→3→ I|1→2→3→4→5→ J|1→2→3→4→

# G2

W32 x19

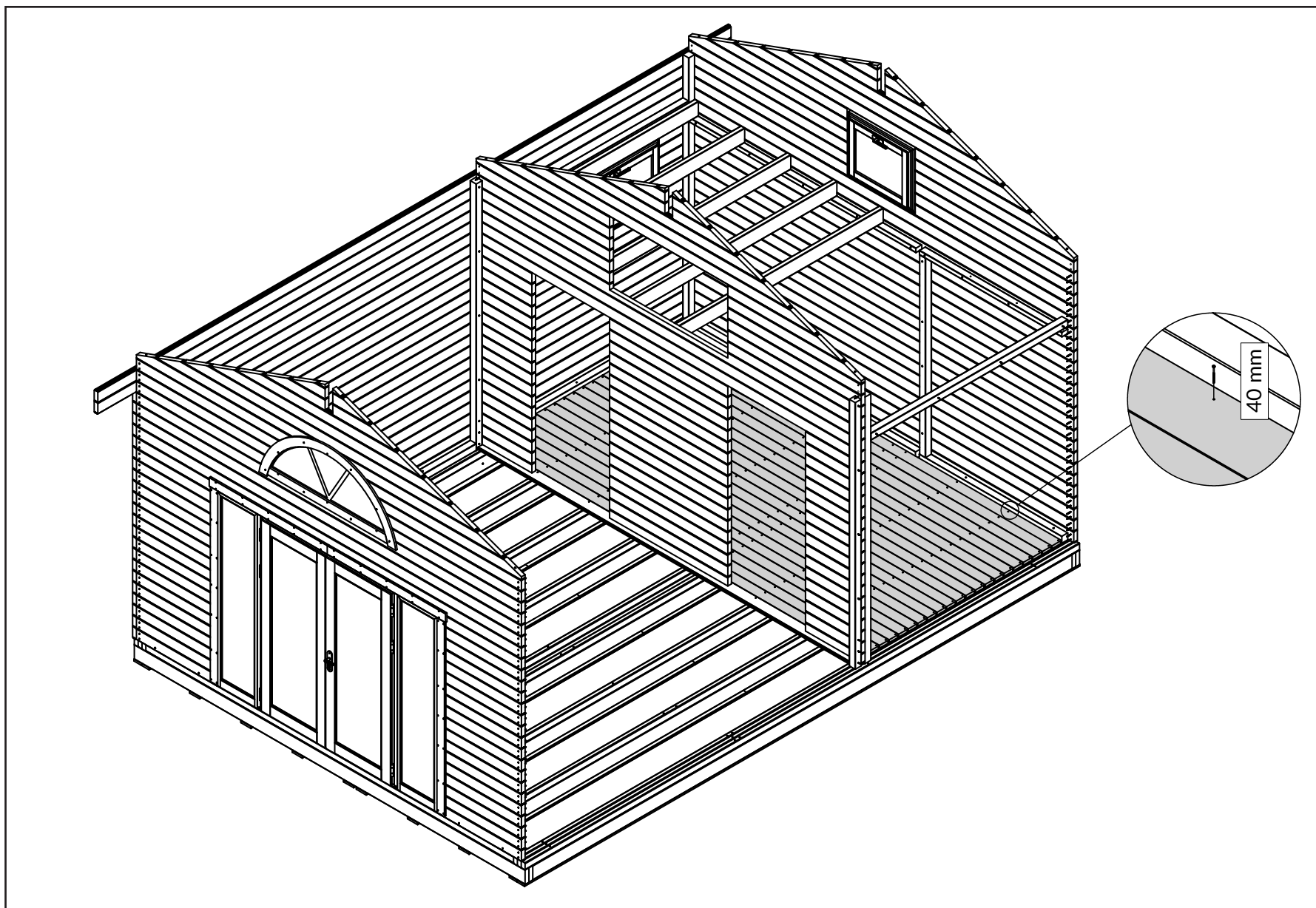

40 mm

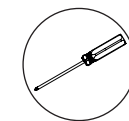
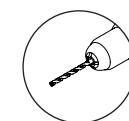

W32 x34

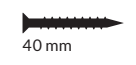
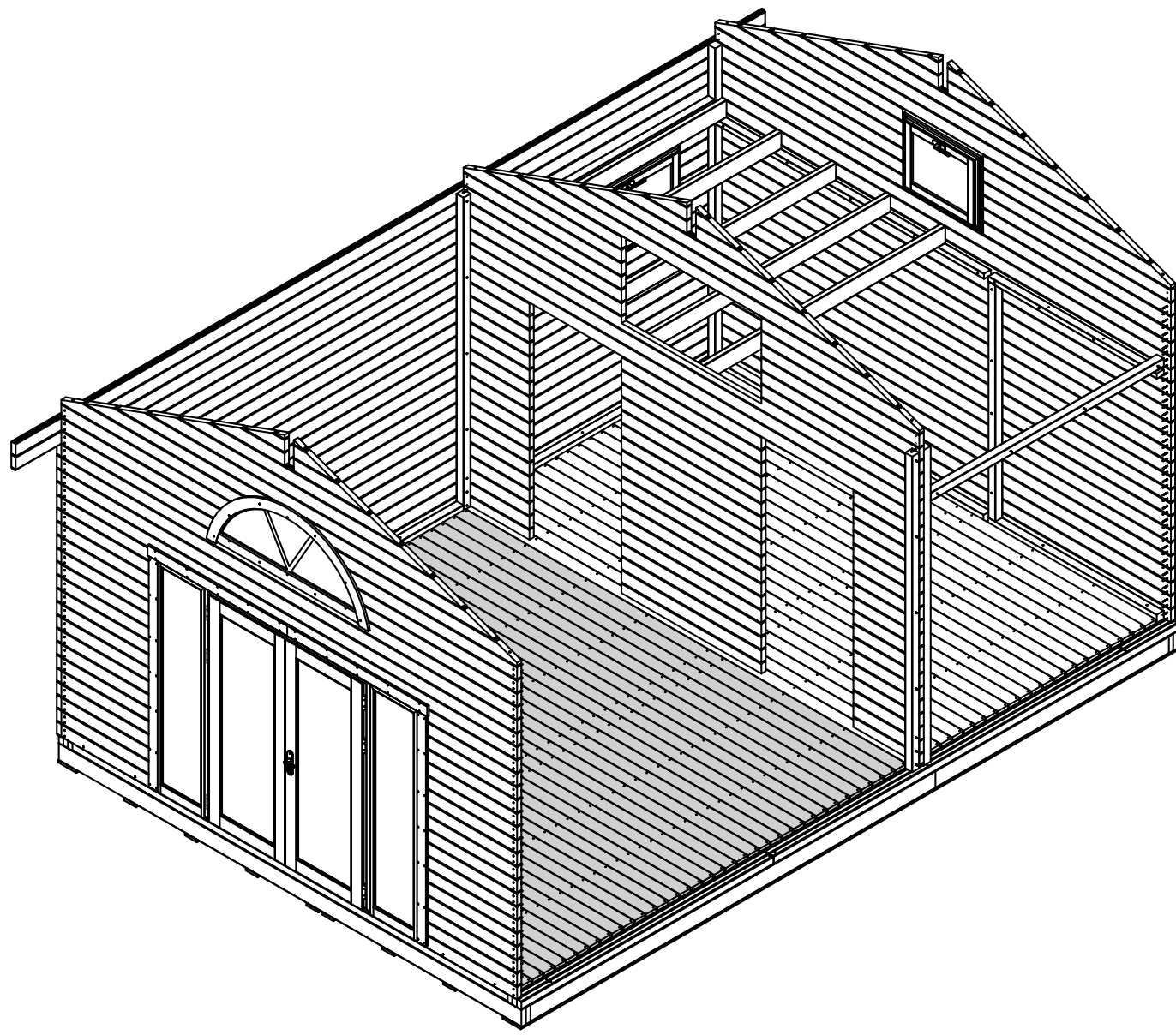

40 mm

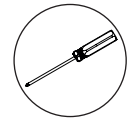
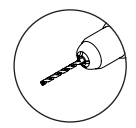





A|1→2→3→4→5→ B|1→2→3→4→5→6→7→8→9→10→11→12→13→14→15→16→17→18→19→20→  
C|1→2→3→4→5→6→7→8→9→ D|1→2→3→4→5→6→7→8→ E|1→2→3→4→5→6→7→  
F|1→2→3→4→5→ G|1→2→3→ H|1→2→3→ I|1→2→3→4→5→ J|1→2→3→4→



# G3

# H

## H

W49  
x1    
(86x44) x 2440mm (009)

W50  
x18    
(114x44) x 2440mm (010)

W51  
x1    
(114x44) x 2440mm (011)

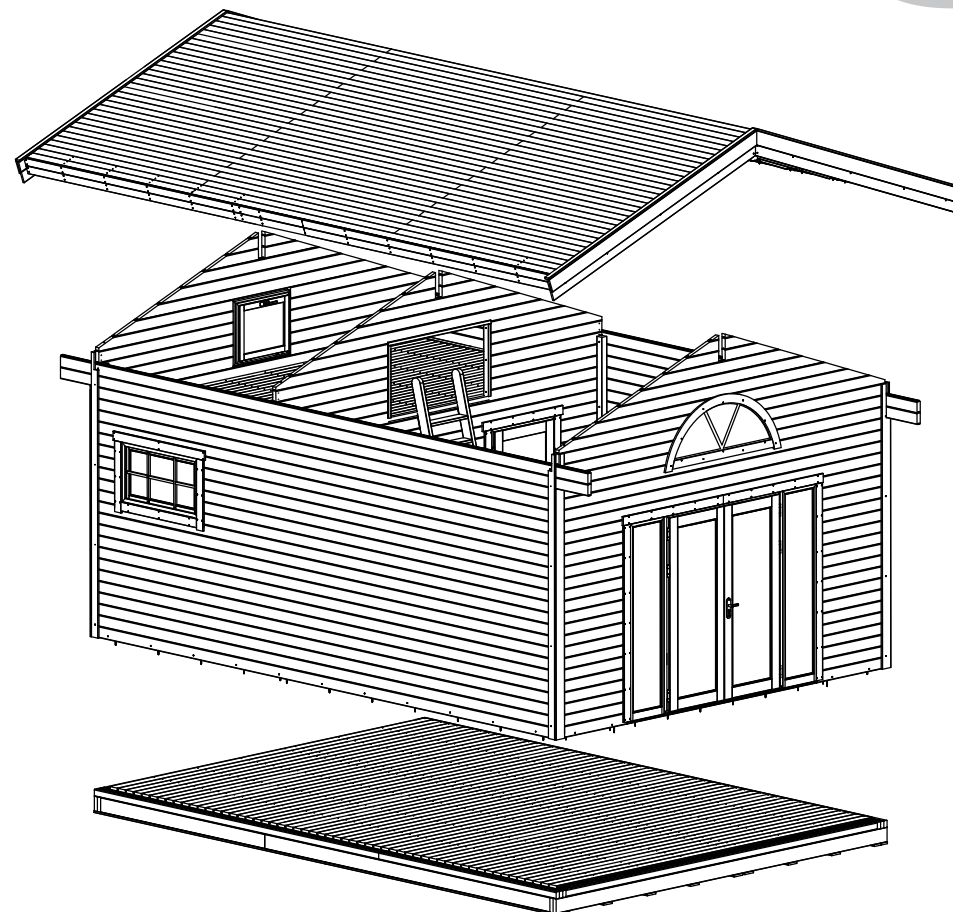
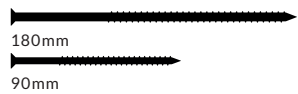



V-1

e	V-1	W49		x1	W49.1
		W50		x19	W50.1
		W51		x1	W51.1
	V-2	W49		x1	W49.2
		W50		x19	W50.2
		W51		x1	W51.2

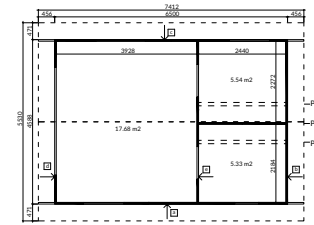

V-1

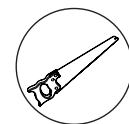

A|1→2→3→4→5→ B|1→2→3→4→5→6→7→8→9→10→11→12→13→14→15→16→17→18→19→20→  
 C|1→2→3→4→5→6→7→8→9→ D|1→2→3→4→5→6→7→8→ E|1→2→3→4→5→6→7→  
 F|1→2→3→4→5→ G|1→2→3→ H|1→2→3→ I|1→2→3→4→5→ J|1→2→3→4→

# H1

A|1→2→3→4→5→ B|1→2→3→4→5→6→7→8→9→10→11→12→13→14→15→16→17→18→19→20→  
C|1→2→3→4→5→6→7→8→9→ D|1→2→3→4→5→6→7→8→ E|1→2→3→4→5→6→7→  
F|1→2→3→4→5→ G|1→2→3→ H|1→2→3→ I|1→2→3→4→5→ J|1→2→3→4→

# H2

W49.1 x1

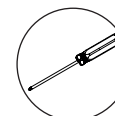
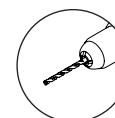
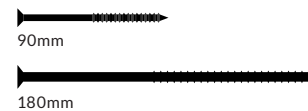
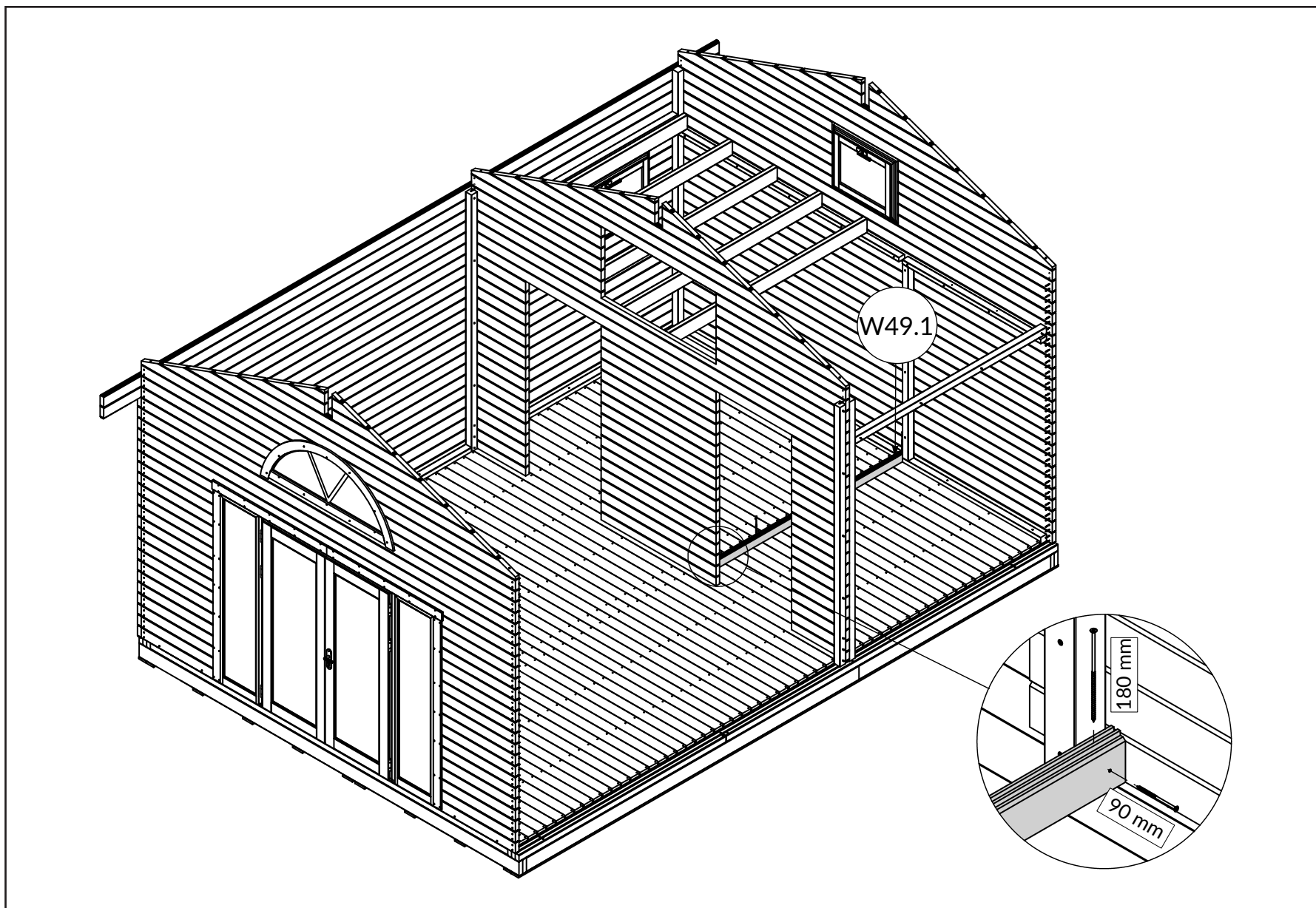

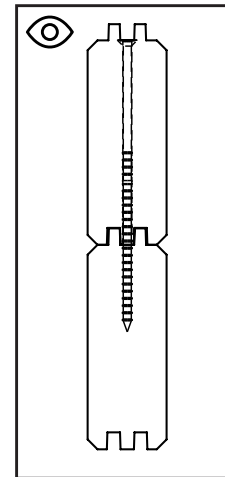
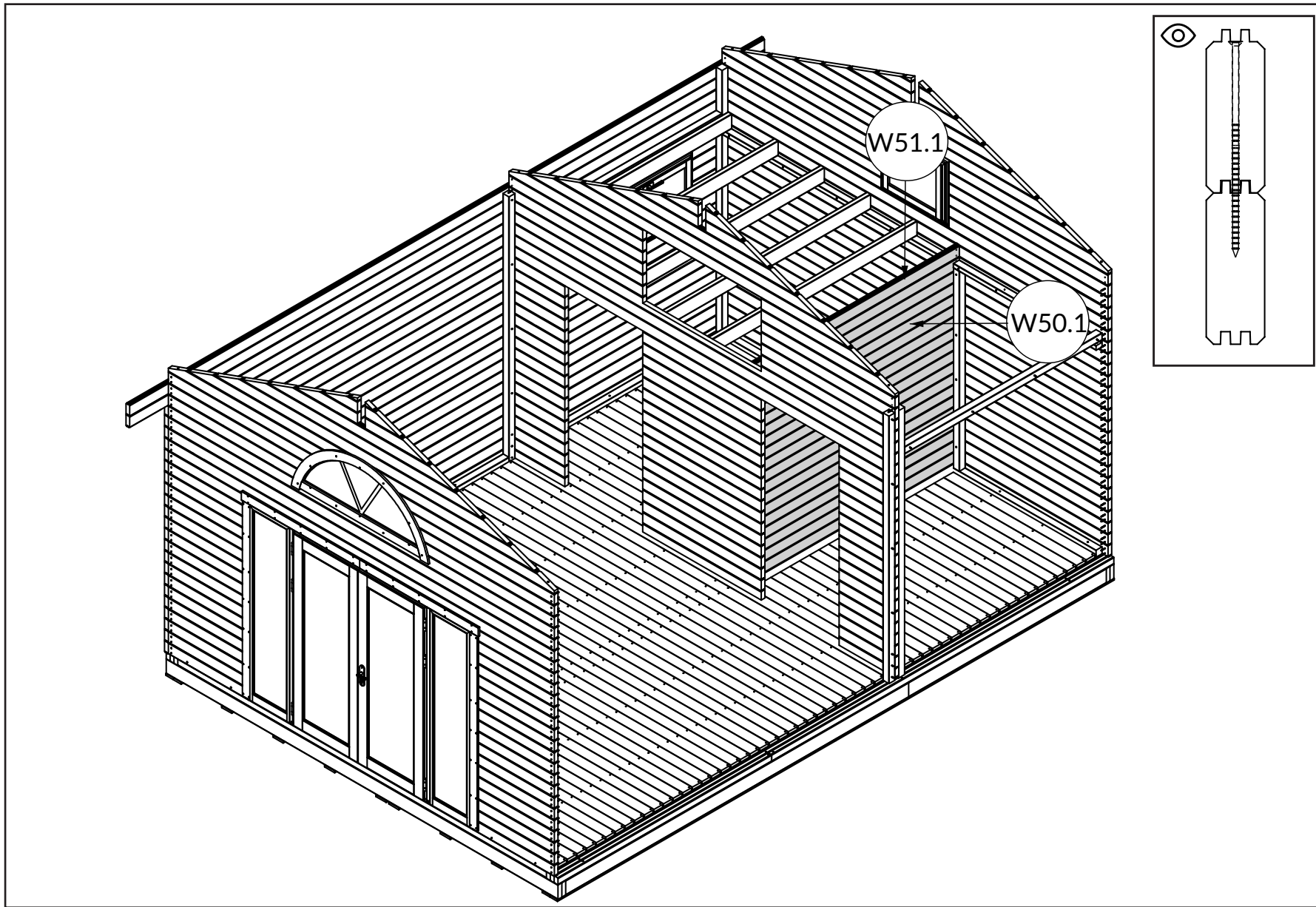

W50.1 x19

W51.1 x1



90mm



180mm

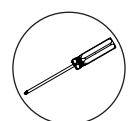
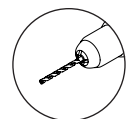
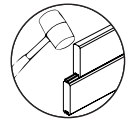

A|1→2→3→4→5→ B|1→2→3→4→5→6→7→8→9→10→11→12→13→14→15→16→17→18→19→20→  
 C|1→2→3→4→5→6→7→8→9→ D|1→2→3→4→5→6→7→8→ E|1→2→3→4→5→6→7→  
 F|1→2→3→4→5→ G|1→2→3→ H|1→2→3→ I|1→2→3→4→5→ J|1→2→3→4→

# H3

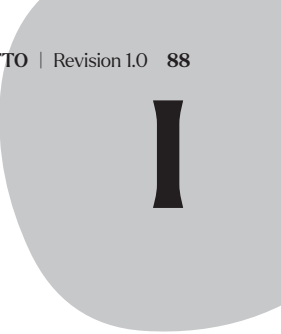

I

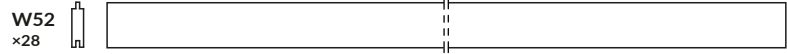

W52  
x28

(90x18.5) x 4360mm (FB-1)



W37  
x4

(146x44) x 2440mm (VT2)



50mm



90mm

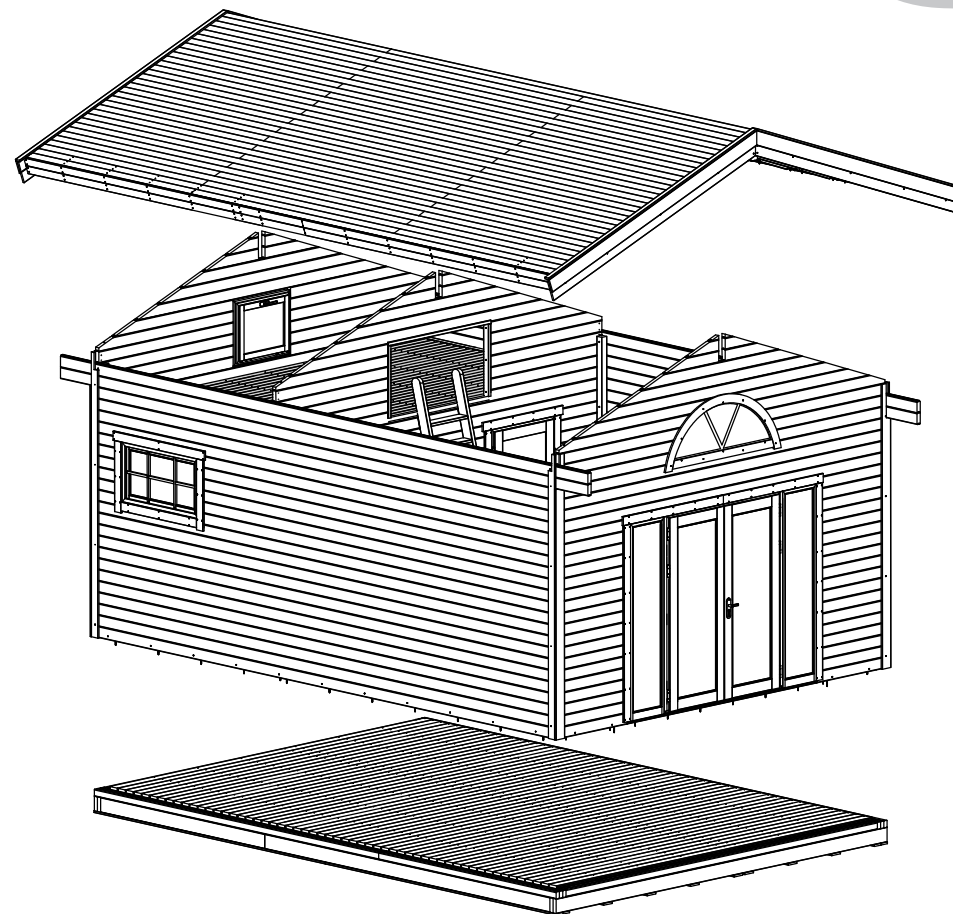

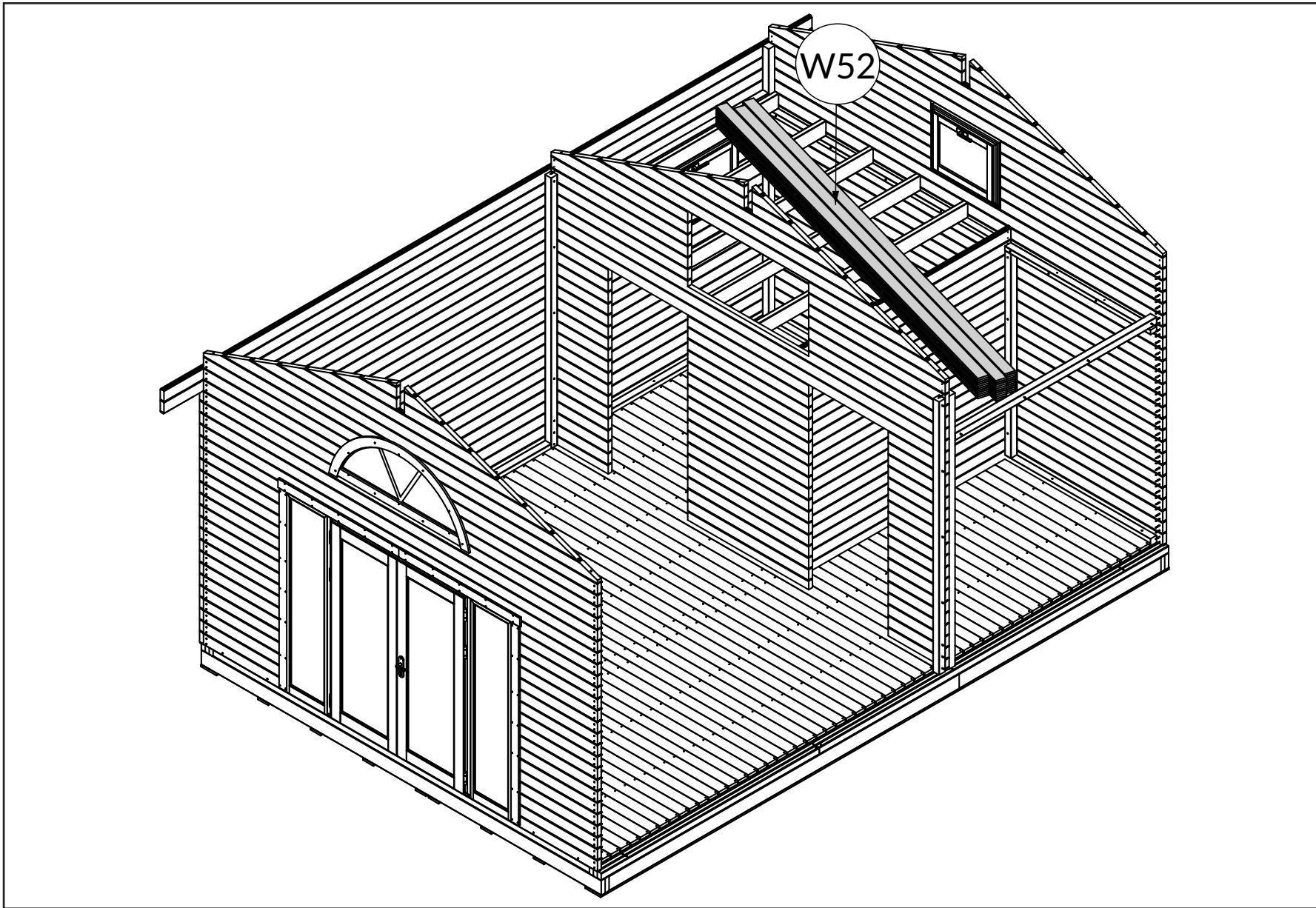

A|1→2→3→4→5→ B|1→2→3→4→5→6→7→8→9→10→11→12→13→14→15→16→17→18→19→20→  
C|1→2→3→4→5→6→7→8→9→ D|1→2→3→4→5→6→7→8→ E|1→2→3→4→5→6→7→  
F|1→2→3→4→5→ G|1→2→3→ H|1→2→3→ I|1→2→3→4→5→ J|1→2→3→4→

A|1→2→3→4→5→ B|1→2→3→4→5→6→7→8→9→10→11→12→13→14→15→16→17→18→19→20→  
C|1→2→3→4→5→6→7→8→9→ D|1→2→3→4→5→6→7→8→ E|1→2→3→4→5→6→7→  
F|1→2→3→4→5→ G|1→2→3→ H|1→2→3→ I|1→2→3→4→5→ J|1→2→3→4→

# I2

W37.1 x1

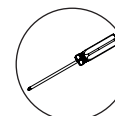
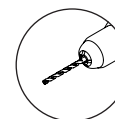
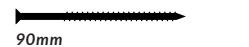
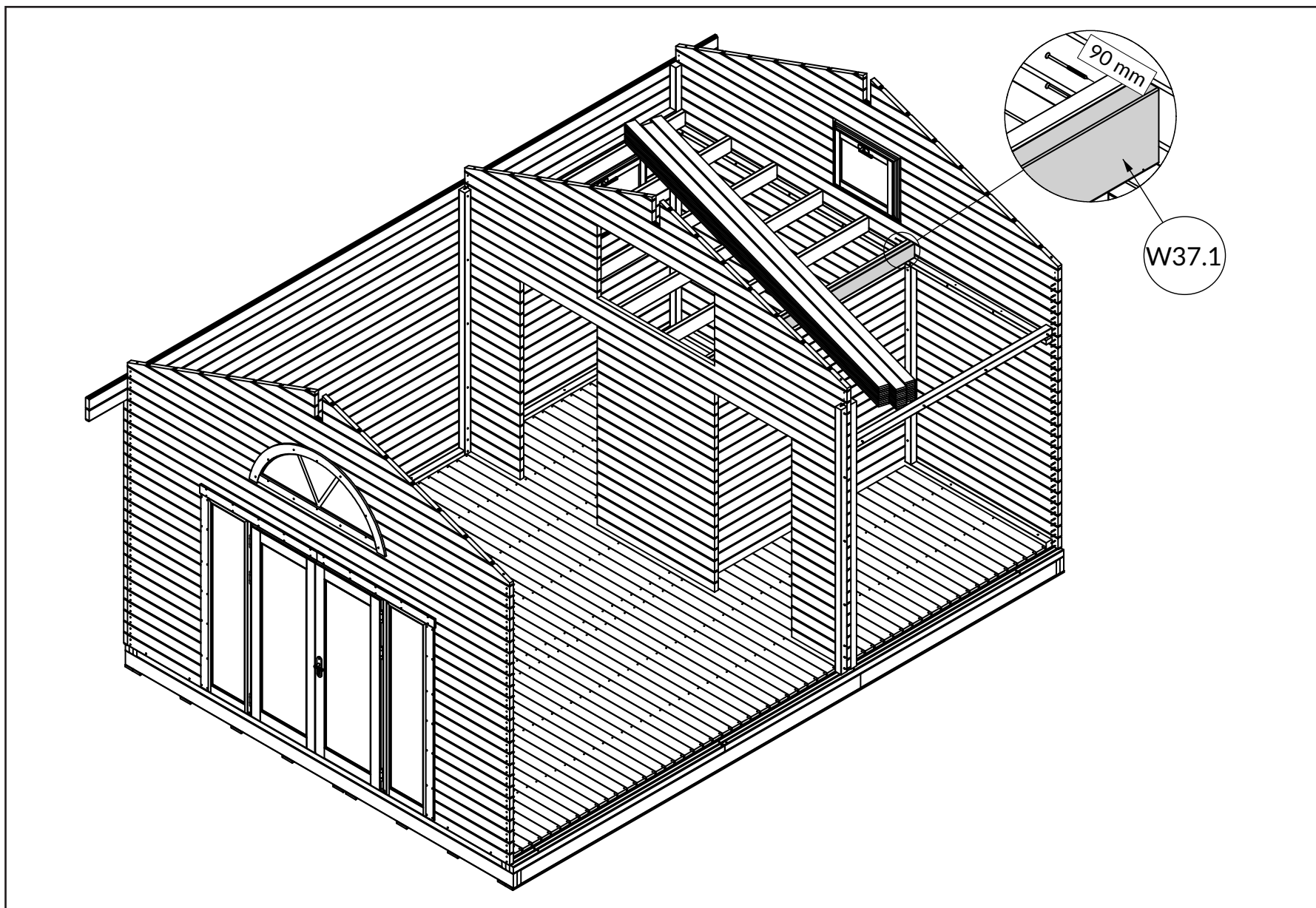

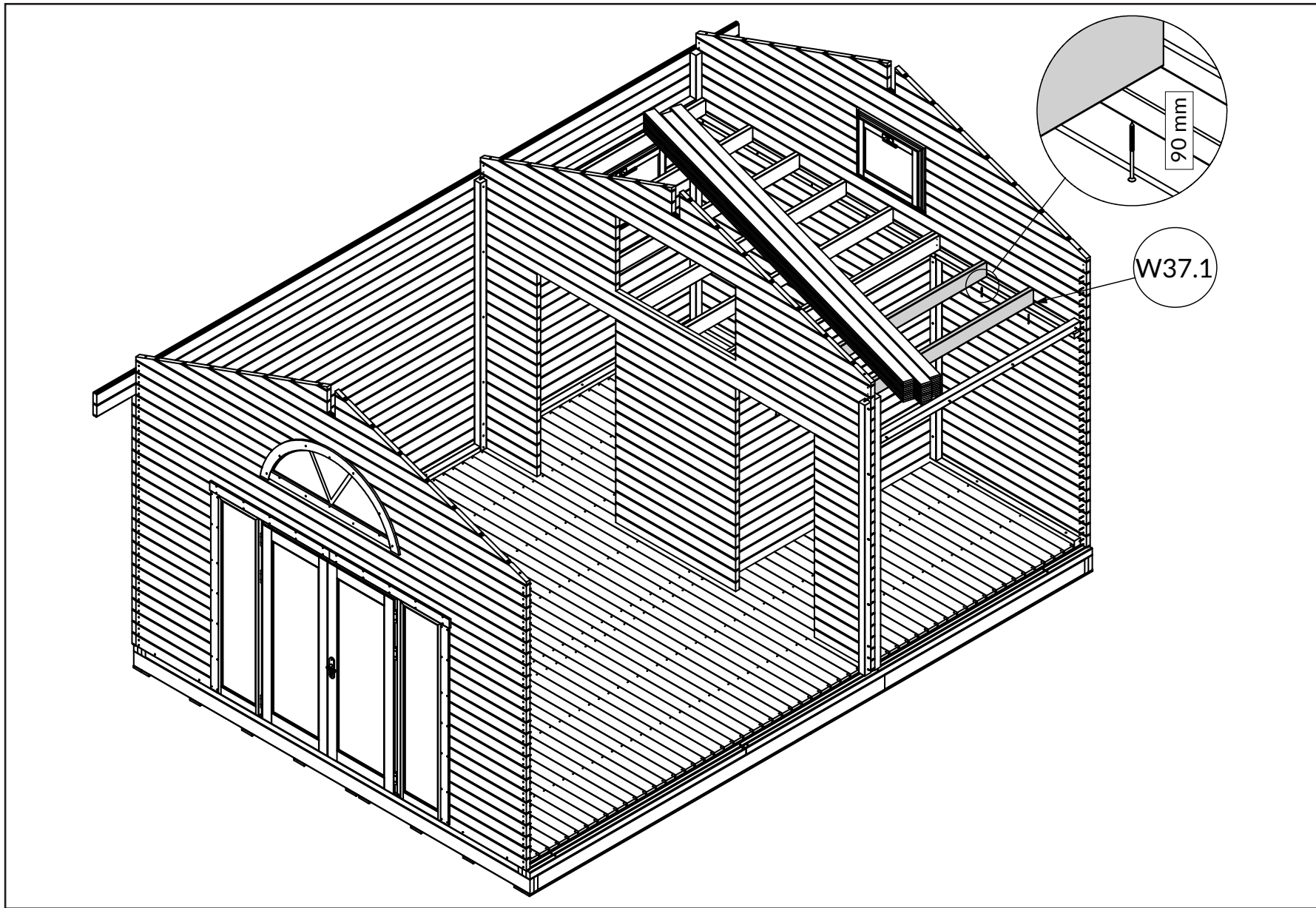

W37.1 x3

W37.1

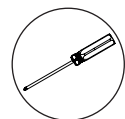
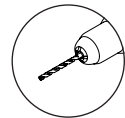

A|1→2→3→4→5→ B|1→2→3→4→5→6→7→8→9→10→11→12→13→14→15→16→17→18→19→20→  
 C|1→2→3→4→5→6→7→8→9→ D|1→2→3→4→5→6→7→8→ E|1→2→3→4→5→6→7→  
 F|1→2→3→4→5→ G|1→2→3→ H|1→2→3→ I|1→2→3→4→5→ J|1→2→3→4→

# I3

A|1→2→3→4→5→ B|1→2→3→4→5→6→7→8→9→10→11→12→13→14→15→16→17→18→19→20→  
C|1→2→3→4→5→6→7→8→9→ D|1→2→3→4→5→6→7→8→ E|1→2→3→4→5→6→7→  
F|1→2→3→4→5→ G|1→2→3→ H|1→2→3→ I|1→2→3→4→5→ J|1→2→3→4→

# 14

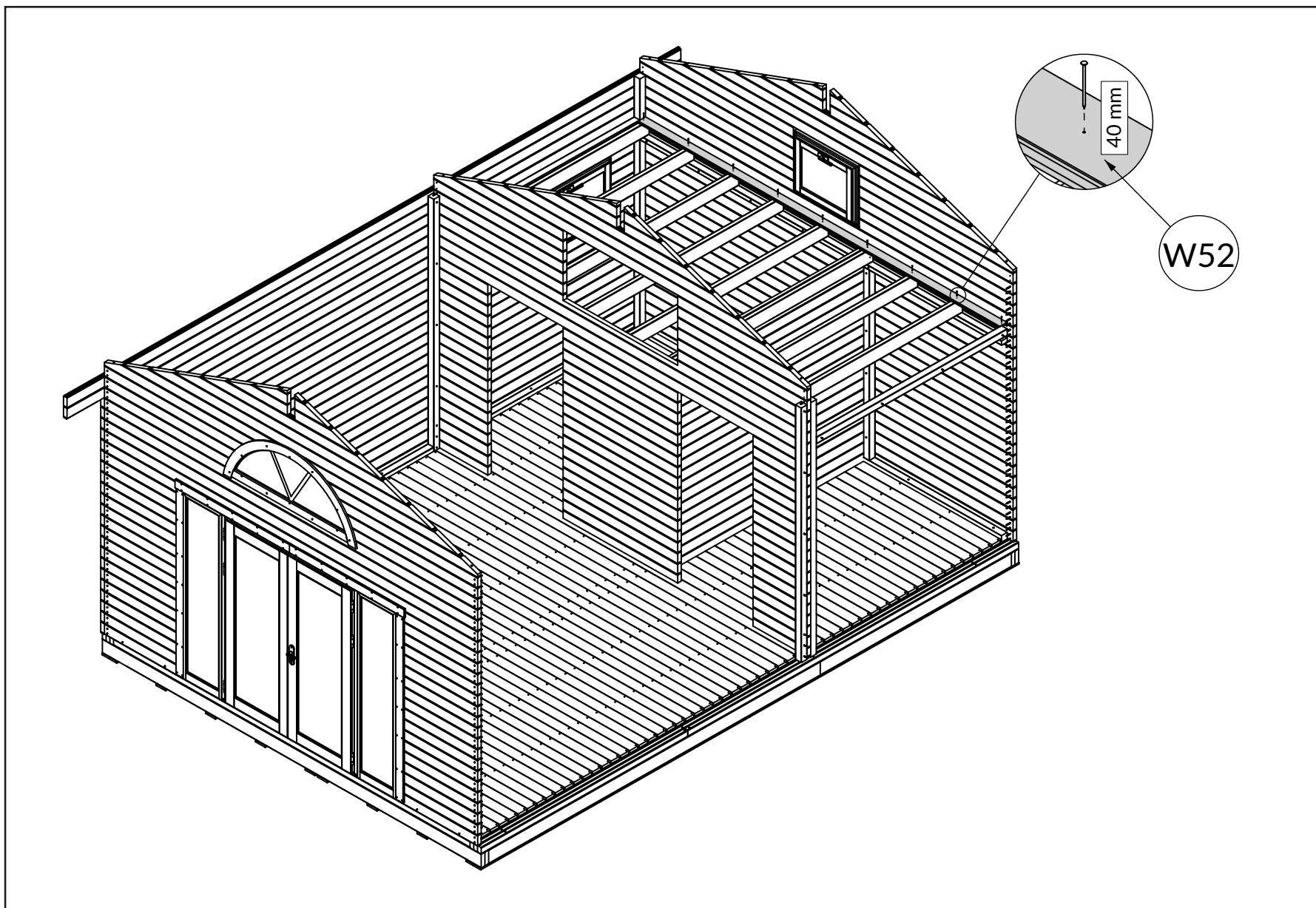

W52 x1

W52

50 mm



W52 x28

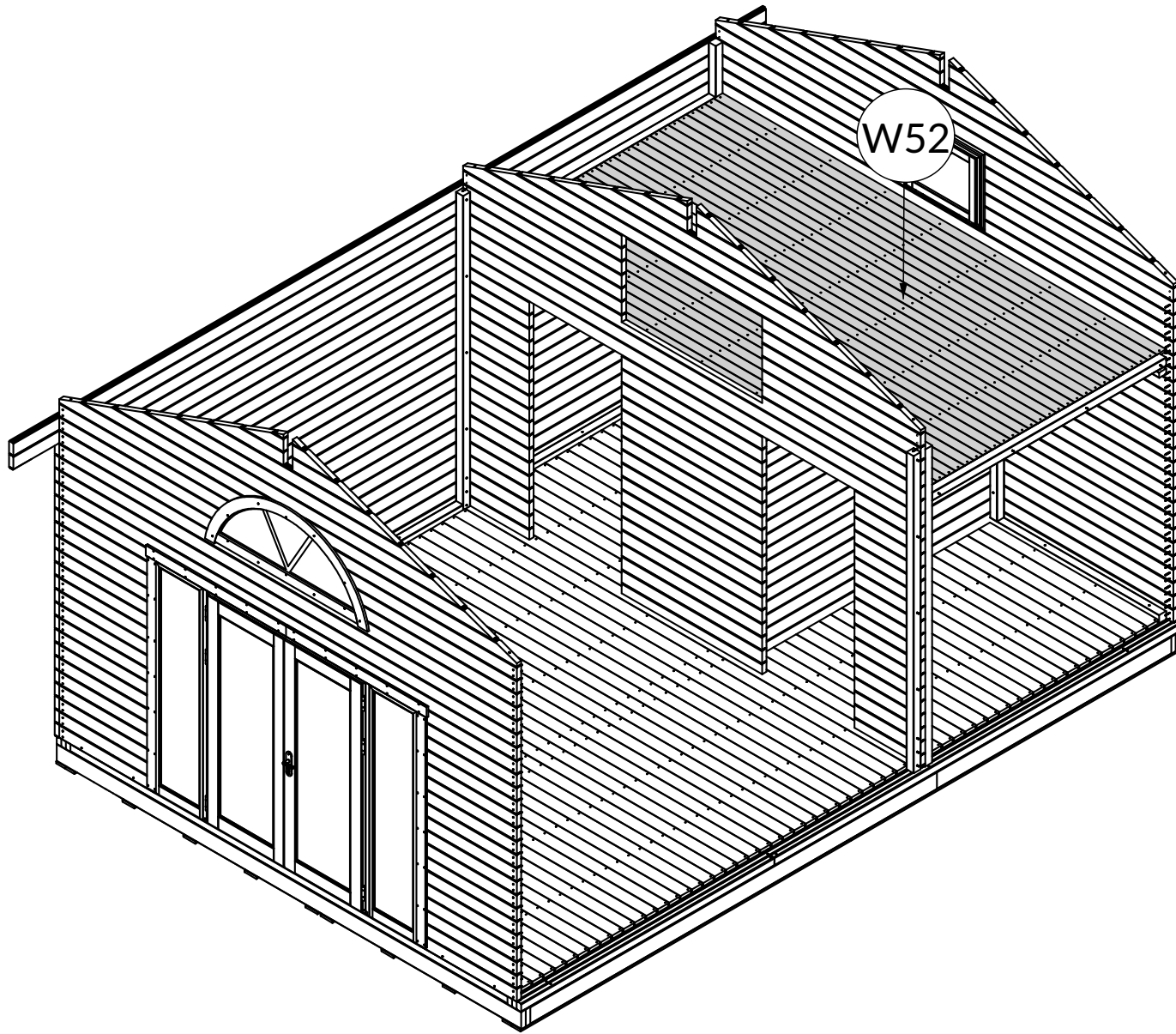

50mm

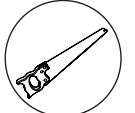



A|1→2→3→4→5→ B|1→2→3→4→5→6→7→8→9→10→11→12→13→14→15→16→17→18→19→20→  
 C|1→2→3→4→5→6→7→8→9→ D|1→2→3→4→5→6→7→8→ E|1→2→3→4→5→6→7→  
 F|1→2→3→4→5→ G|1→2→3→ H|1→2→3→ I|1→2→3→4→5→ J|1→2→3→4→

# 15

## J

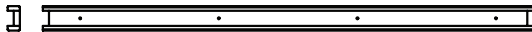
W53  
x2  
  
(70x35) x 740mm (UT-1)

W54  
x1  
  
(70x35) x 1400mm (UT-2)

W55  
x4  
  
(120x18) x 2850mm (RS2)

W56  
x4  
  
(120x18) x 2850mm (RS1)

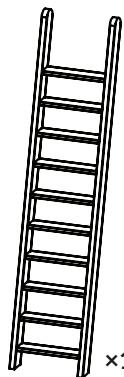

x1



x1



x1

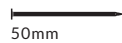

50mm



60mm

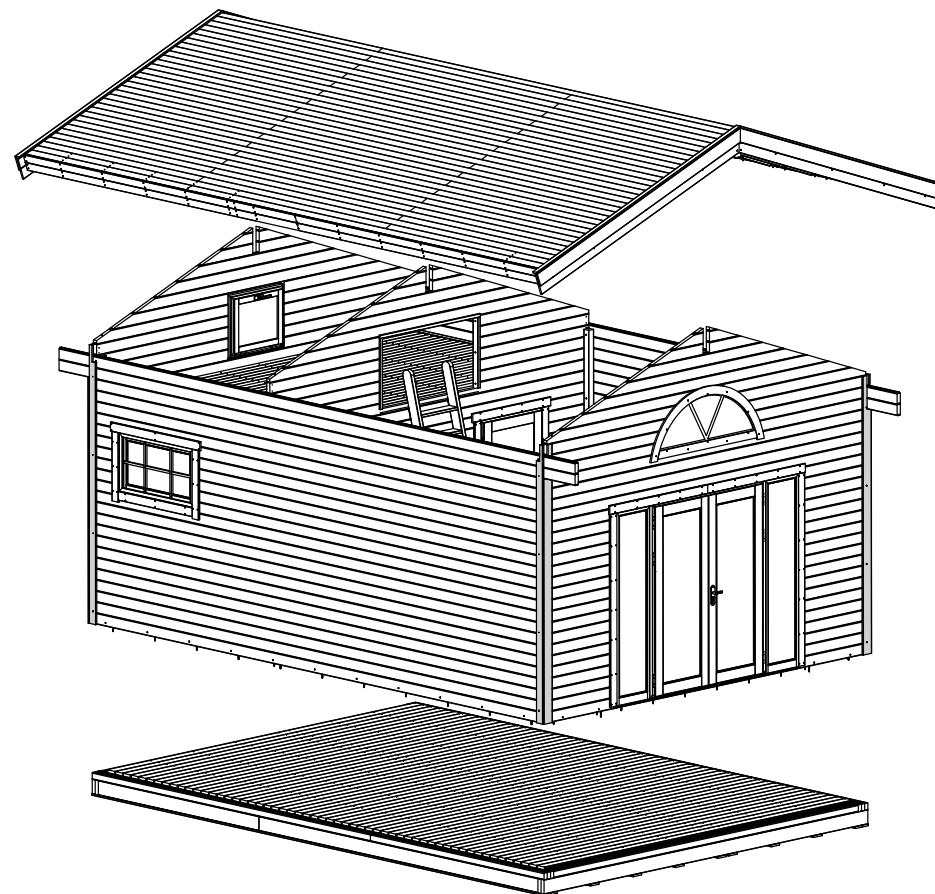

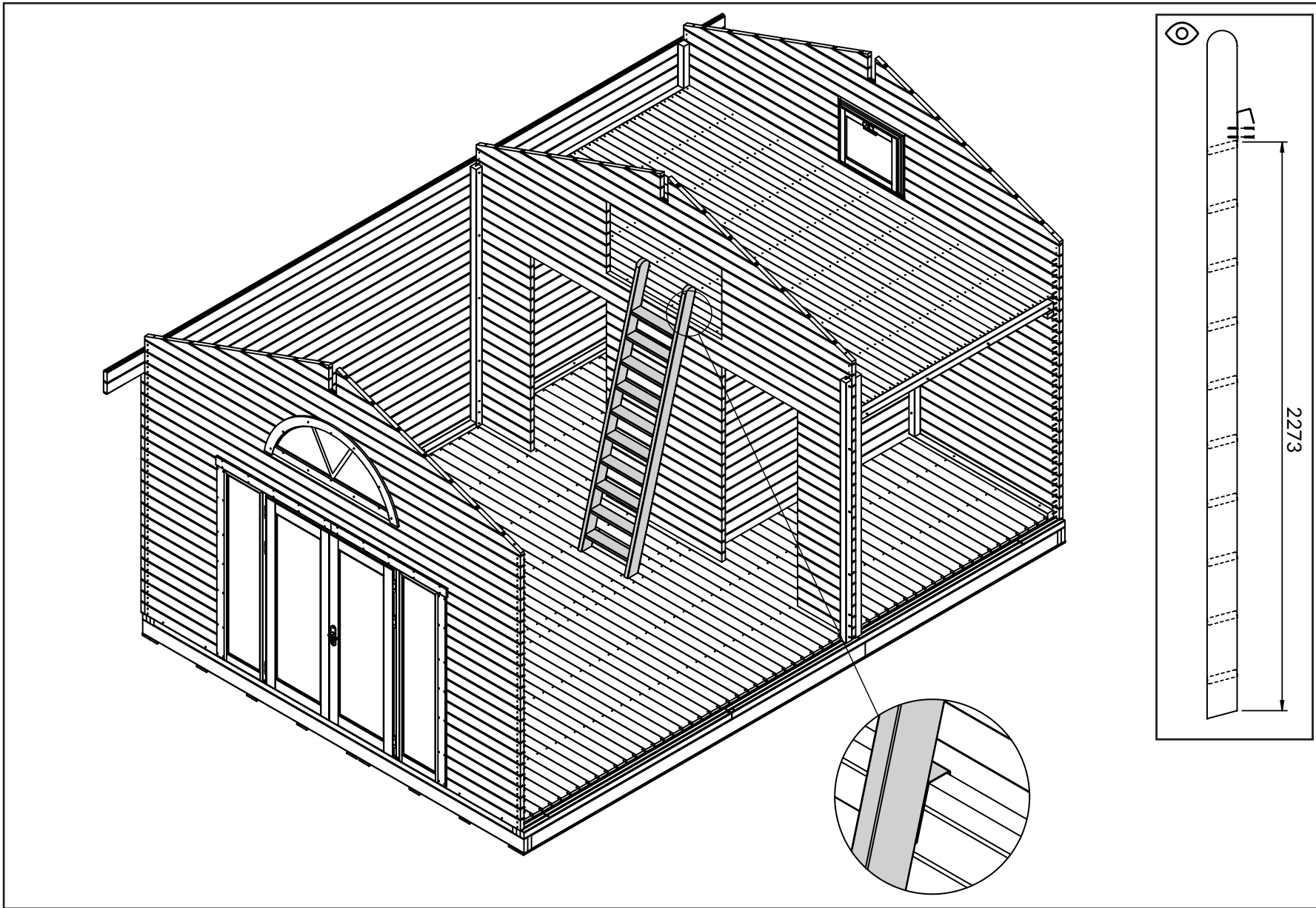

A|1→2→3→4→5→ B|1→2→3→4→5→6→7→8→9→10→11→12→13→14→15→16→17→18→19→20→  
 C|1→2→3→4→5→6→7→8→9→ D|1→2→3→4→5→6→7→8→ E|1→2→3→4→5→6→7→  
 F|1→2→3→4→5→ G|1→2→3→ H|1→2→3→ I|1→2→3→4→5→ J|1→2→3→4→

**J1**

# J2

A|1→2→3→4→5→ B|1→2→3→4→5→6→7→8→9→10→11→12→13→14→15→16→17→18→19→20→  
C|1→2→3→4→5→6→7→8→9→ D|1→2→3→4→5→6→7→8→ E|1→2→3→4→5→6→7→  
F|1→2→3→4→5→ G|1→2→3→ H|1→2→3→ I|1→2→3→4→5→ J|1→2→3→4→

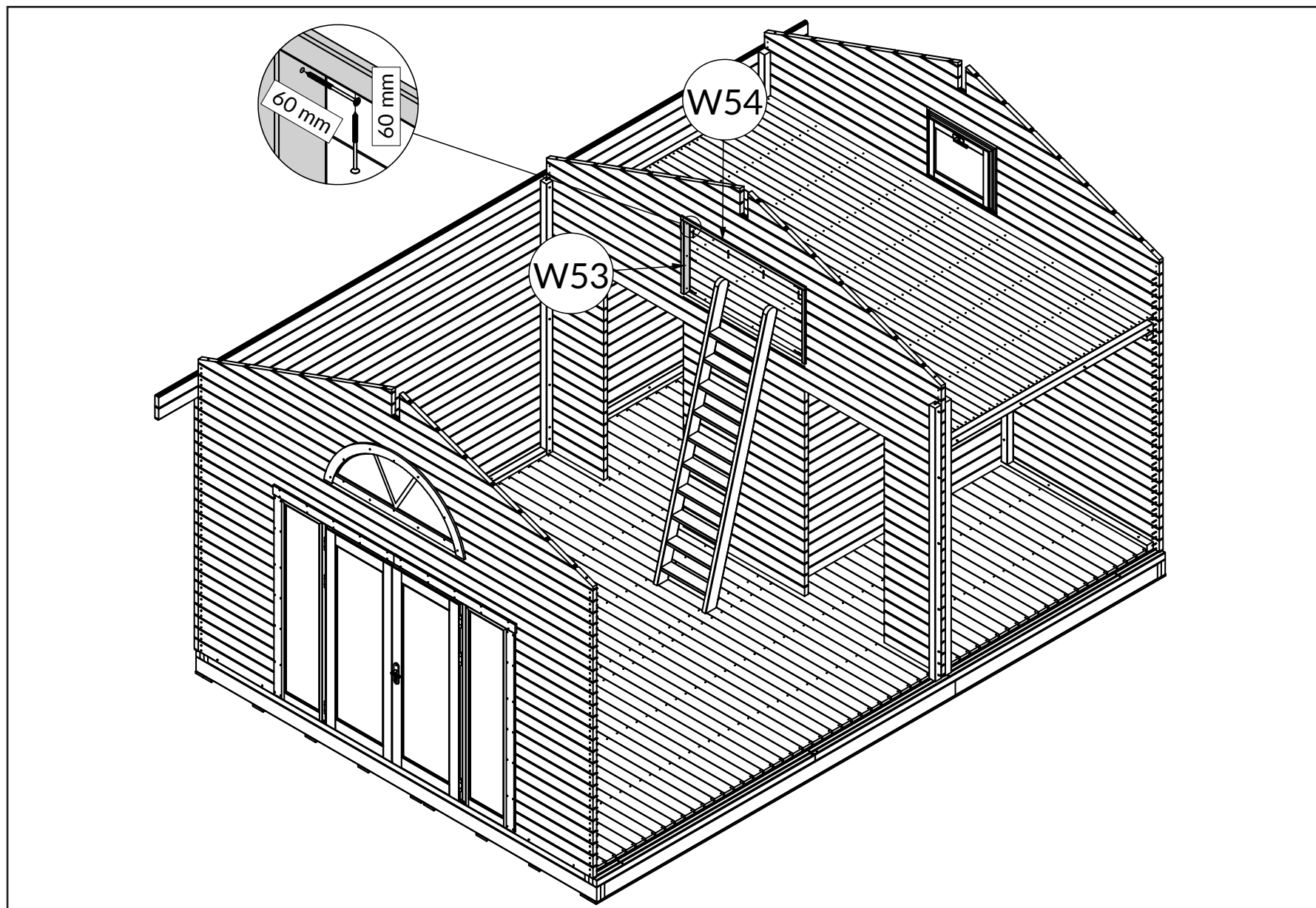

W53 x2

W54 x1

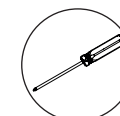
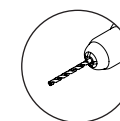
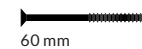

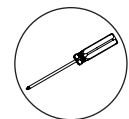
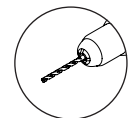
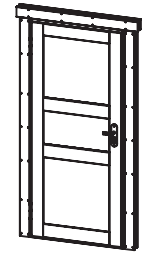
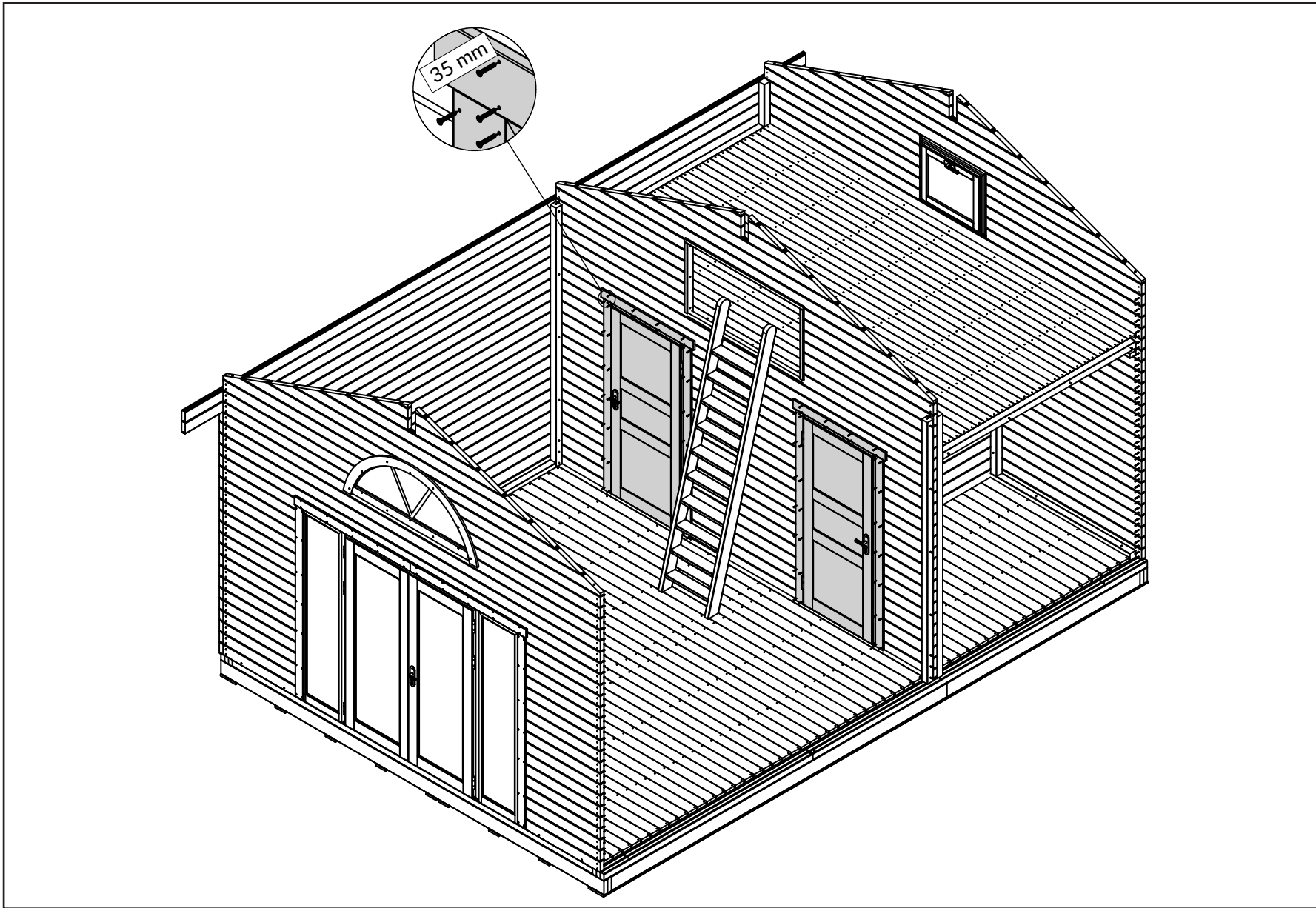

A|1→2→3→4→5→ B|1→2→3→4→5→6→7→8→9→10→11→12→13→14→15→16→17→18→19→20→  
 C|1→2→3→4→5→6→7→8→9→ D|1→2→3→4→5→6→7→8→ E|1→2→3→4→5→6→7→  
 F|1→2→3→4→5→ G|1→2→3→ H|1→2→3→ I|1→2→3→4→5→ J|1→2→3→4→

# J3

# J4

A|1→2→3→4→5→ B|1→2→3→4→5→6→7→8→9→10→11→12→13→14→15→16→17→18→19→20→  
C|1→2→3→4→5→6→7→8→9→ D|1→2→3→4→5→6→7→8→ E|1→2→3→4→5→6→7→  
F|1→2→3→4→5→ G|1→2→3→ H|1→2→3→ I|1→2→3→4→5→ J|1→2→3→4→

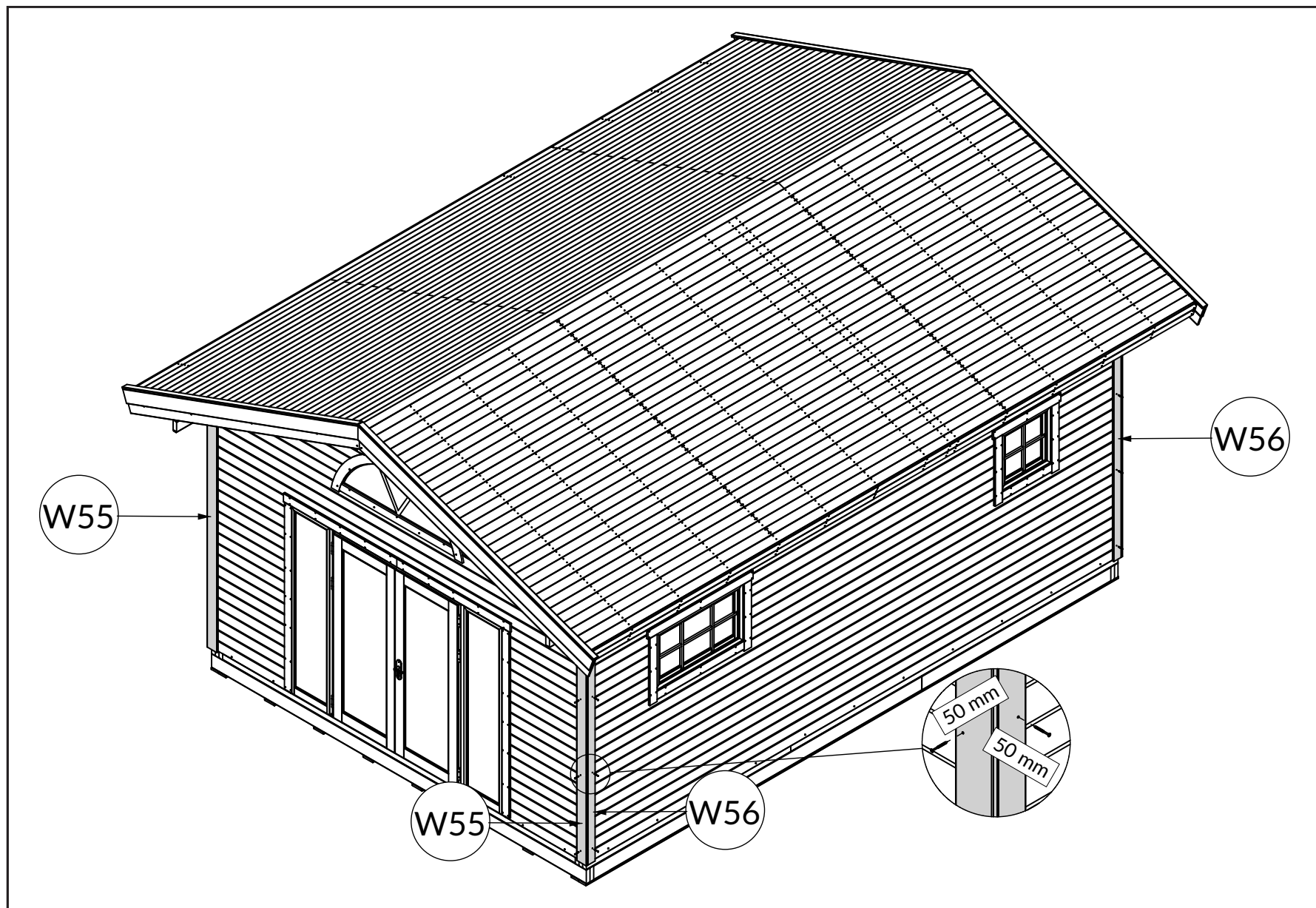

W55 x4

W56 x4

W56

W55

W55

W56

50 mm  
50 mm

50 mm

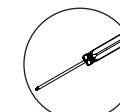

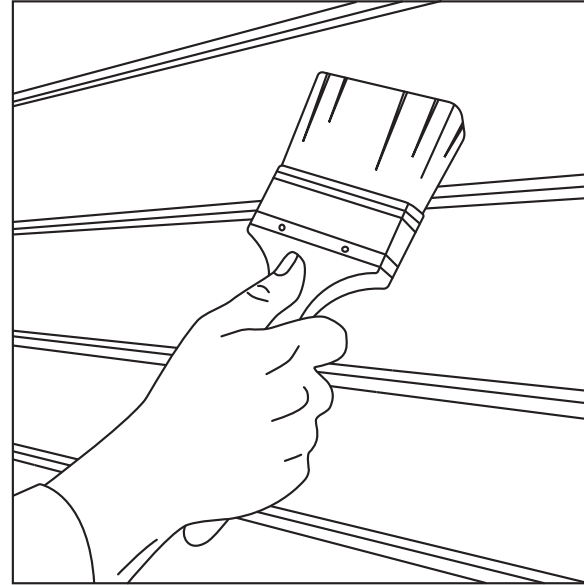
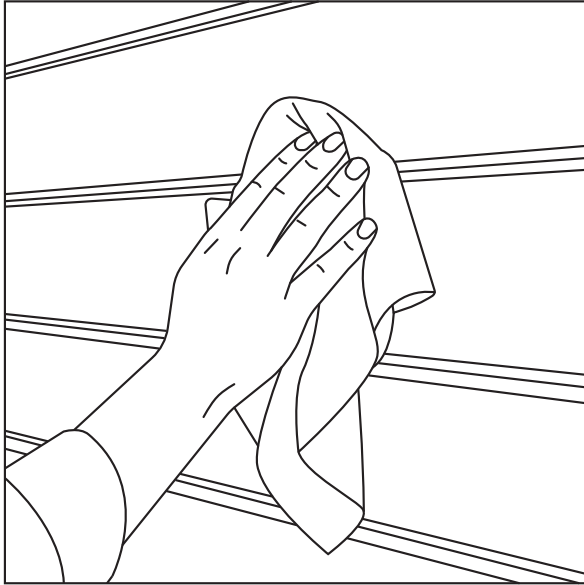

**polhus.com**







Polhus was founded in Mora, a small town in the heart of Sweden, known for its craftsmanship tradition. We build wooden houses and saunas to bring joy, laughter and shared moments into your home and everyday life.

## *Crafting* MOMENTS