

MINNA

S2020/44-MINNA | Revision 1.3

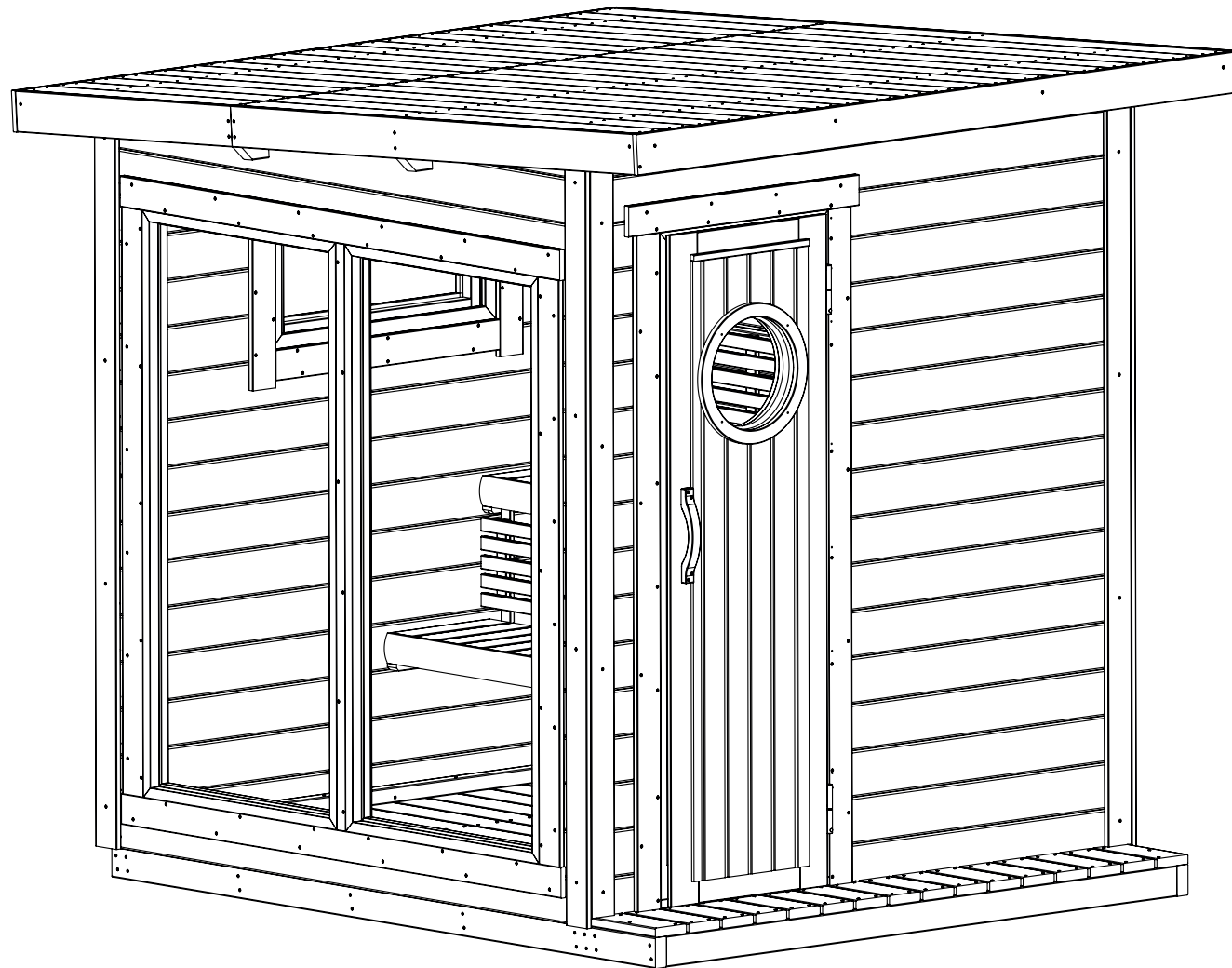

#ID

EN

Read and understand the instruction manual before starting installation.

Our products are manufactured using premium quality timber. Strict selection processes ensure that all timber is cut and planed to the correct specifications. However, wood is a natural material and will experience changes in both appearance and composition throughout its life cycle.

This means that it may develop openings in the wood structure following the grain, including gaps, apertures, cracks, and splits. These gaps are expected during drier and wetter seasons. This is not a cause for concern and will not affect the structural integrity or the product's guarantee.

Always remember:

- Pre-drill the indicated holes.
- Unpacking and assembly should be done by at least two people to avoid accident
- Wear gloves and safety glasses.
- Prepare a firm, level foundation before assembly.

For more information, you will find the general manual and our general terms and conditions at www.polhus.com

DE

Bitte lesen und verstehen Sie die Bedienungsanleitung vollständig, bevor Sie mit der Installation beginnen.

Unsere Produkte bestehen aus hochwertigem Holz. Durch strenge Auswahlprozesse stellen wir sicher, dass das Holz gemäß den festgelegten Spezifikationen geschnitten und gehobelt wird. Da Holz ein Naturmaterial ist, unterliegt es im Laufe der Zeit optischen und strukturellen Veränderungen.

- Entlang der Maserung können sich Risse, Spalten und Öffnungen bilden.
- Diese Veränderungen sind natürliche Reaktionen auf wechselnde Feuchtigkeits- und Klimabedingungen.
- Sie beeinträchtigen weder die strukturelle Stabilität noch die Garantie des Produkts.

Wichtige Montagehinweise:

- Bohren Sie stets die angegebenen Löcher vor.
- Das Auspacken und die Montage sollten aus Sicherheitsgründen von mindestens zwei Personen durchgeführt werden.
- Tragen Sie während der Montage geeignete Schutzausrüstung, einschließlich Handschuhen und Schutzbrille.
- Bereiten Sie vor der Montage eine stabile und ebene Grundlage vor.

Detaillierte Informationen finden Sie im allgemeinen Handbuch sowie in unseren Geschäftsbedingungen unter www.polhus.com

FR

Lisez attentivement le manuel d'instruction avant de commencer l'installation.

Nos produits sont fabriqués en bois de haute qualité, soigneusement sélectionné, coupé et raboté selon des spécifications précises. Cependant, le bois étant un matériau naturel, il évolue au fil du temps, tant dans son apparence que dans sa structure.

Des fissures, interstices et fentes peuvent apparaître le long des veines du bois en fonction des variations saisonnières d'humidité. Ces phénomènes sont normaux et n'affectent ni la solidité du produit ni sa garantie.

Consignes importantes:

- Percez toujours les trous prévus à l'avance.
- Le déballage et le montage doivent être réalisés par au moins deux personnes pour éviter tout risque d'accident.
- Portez des gants et des lunettes de protection.
- Assurez-vous de préparer une base stable et parfaitement nivelée avant de commencer l'assemblage.

Pour plus d'informations, consultez le manuel général ainsi que nos conditions générales sur la page web de votre pays: www.polhus.com

NL

Lees en begrijp de handleiding voordat u met de installatie begint.

Alle producten worden vervaardigd van hoogwaardig hout. Strenge selectieprocessen zorgen ervoor dat al het hout volgens de juiste specificaties wordt gezaagd en geschaafd. Hout is echter een natuurlijk materiaal en zal gedurende zijn levenscyclus veranderingen ondergaan in zowel uiterlijk als samenstelling.

Dit betekent dat er openingen kunnen ontstaan in de houtstructuur langs de nerf, zoals spleten, barsten en scheuren. Deze veranderingen zijn normaal tijdens zowel droge als vochtige seizoenen. Dit is geen reden tot bezorgdheid en heeft geen invloed op de structurele integriteit of de garantie van het product.

Onthoud altijd:

- Boor altijd de aangegeven gaten voor.
- Het uitpakken en monteren dient door minimaal twee personen te worden uitgevoerd om ongelukken te voorkomen.
- Draag handschoenen en een veiligheidsbril.
- Zorg voor een stevige en vlakke ondergrond voordat u met de montage begint.

Voor meer informatie vindt u de algemene handleiding en onze algemene voorwaarden op de website: www.polhus.com

PL

Przeczytaj i upewnij się, że rozumiesz instrukcję przed rozpoczęciem instalacji.

Nasze produkty powstają z doskonałej jakości materiałów. Surowe procesy kontroli produkcji gwarantują cięcie i heblowanie zgodne z najwyższymi standardami. Należy jednak pamiętać, że drewno to naturalny surowiec, który stopniowo zmienia zarówno swój wygląd, jak i strukturę.

Wraz z upływem czasu na powierzchni desek i belek mogą pojawić się szczeliny, pęknięcia i rysy. Zmiany te są naturalne i zależne od natężenia wilgoci w różnych porach roku. Nie stanowią one powodu do niepokoju i nie wpływają na integralność konstrukcyjną ani gwarancję produktu.

Pamiętaj o:

- wstępnym nawierceniu wszystkich wskazanych otworów;
- rozpakowaniu i montażu elementów przez co najmniej dwie osoby, aby uniknąć wypadków;
- noszeniu rękawic i okularów ochronnych;
- przygotowaniu solidnego i równego fundamentu przed rozpoczęciem montażu.

Więcej informacji, w tym ogólną instrukcję montażu oraz regulamin, znajdziesz na stronie internetowej www.polhus.com

SE

Läs och förstå manualen innan du påbörjar installationen.

Alla våra produkter tillverkas av högkvalitativt trä. Strikta urvalsprocesser säkerställer att allt trä kapas och hyvlas utefter givna specifikationer. Trä är dock ett naturligt material och kommer att förändras både i utseende och sammansättning under sin livscykel.

Detta innebär att träet kan utveckla sprickor och öppningar längs fibrerna, inklusive glipor, springor och sprickbildning. Dessa variationer är normala under både torra och fuktiga perioder. Detta är inte något att oroa sig för och påverkar varken den strukturella hållfastheten eller produktens garanti.

Kom ihåg att:

- Förborra alltid de angivna hålen.
- Uppackning och montering bör utföras av minst två personer för att undvika olyckor.
- Använd handskar och skyddsglasögon.
- Förbered en stabil och jämn grund innan montering.

För mer information hittar du den allmänna manualen och våra allmänna villkor på www.polhus.com

NO

Les og forstå bruksanvisningen før du starter installasjonen.

Alle produkter er laget av trevirke av høy kvalitet. Strenge utvalgsriterier sikrer at alt treverk blir kuttet og høvlet i henhold til riktige spesifikasjoner. Tre er imidlertid et naturlig materiale og vil endre både utseende og sammensetning gjennom sin livssyklus.

Dette betyr at treet kan utvikle åpninger i strukturen langs årringene, inkludert sprekker, glipper og revner. Disse variasjonene er normale i både tørre og fuktige perioder. Dette er ikke noe å bekymre seg for og vil ikke påvirke den strukturelle integriteten eller produktets garanti.

Husk å:

- Forbor alltid de angitte hullene.
- Oppakking og montering bør utføres av minst to personer for å unngå ulykker.
- Bruk hansker og vernebriller.
- Forbered et solid og jevnt fundament før montering.

For mer informasjon finner du den generelle manualen og våre generelle vilkår på www.polhus.com

DK

Læs og forstå brugsanvisningen, før du påbegynder installationen.

Alle produkter er fremstillet af træ af høj kvalitet. Strenge udvælgelsesprocesser sikrer, at alt træ skæres og høvles i henhold til de korrekte specifikationer. Træ er dog et naturligt materiale og vil ændre både udseende og sammensætning gennem sin livscyklus.

Dette betyder, at træet kan udvikle åbninger i strukturen langs årene, herunder sprækker, revner og mellemrum. Disse variationer er normale i både tørre og fugtige perioder. Dette er ikke grund til bekymring og påvirker hverken den strukturelle integritet eller produktets garanti.

Husk at:

- Forbor altid de angivne huller.
- Udpakning og montering bør udføres af mindst to personer for at undgå ulykker.
- Brug handsker og sikkerhedsbriller.
- Forbered et fast og jævnt fundament inden montering.

For mere information finder du den generelle manual og vores generelle vilkår på www.polhus.com

Lue ja ymmärrä käyttöohje ennen asennuksen aloittamista.

Kaikki tuotteet valmistetaan korkealaatuisesta puusta. Tiukat valintaprosessit varmistavat, että kaikki puu leikataan ja höylätään oikeiden spesifikaatioiden mukaisesti. Puu on kuitenkin luonnonmateriaali ja sen ulkonäkö sekä koostumus muuttuvat sen elinkaaren aikana.

Tämä tarkoittaa, että puuhun voi muodostua rakenteellisia avautumia syiden suuntaisesti, kuten rakoja, halkeamia ja uurteita. Nämä muutokset ovat normaaleja sekä kuivina että kosteina kausina. Tämä ei ole syy huoleen, eikä se vaikuta rakenteelliseen kestävyYTEEN tai tuotteen takuuseen.

Muista että:

- Esiporaa aina merkityt reiät.
- Pakkauksen purkaminen ja kokoaminen tulisi suorittaa vähintään kahden henkilön voimin tapaturmien välttämiseksi.
- Käytä käsineitä ja suojalaseja.
- Valmistele tukeva ja tasainen perusta ennen kokoamista.

Lisätietoja löydät yleisestä käyttöoppaasta ja yleisistä ehdoistamme kunkin maan verkkosivustolta osoitteessa www.polhus.com

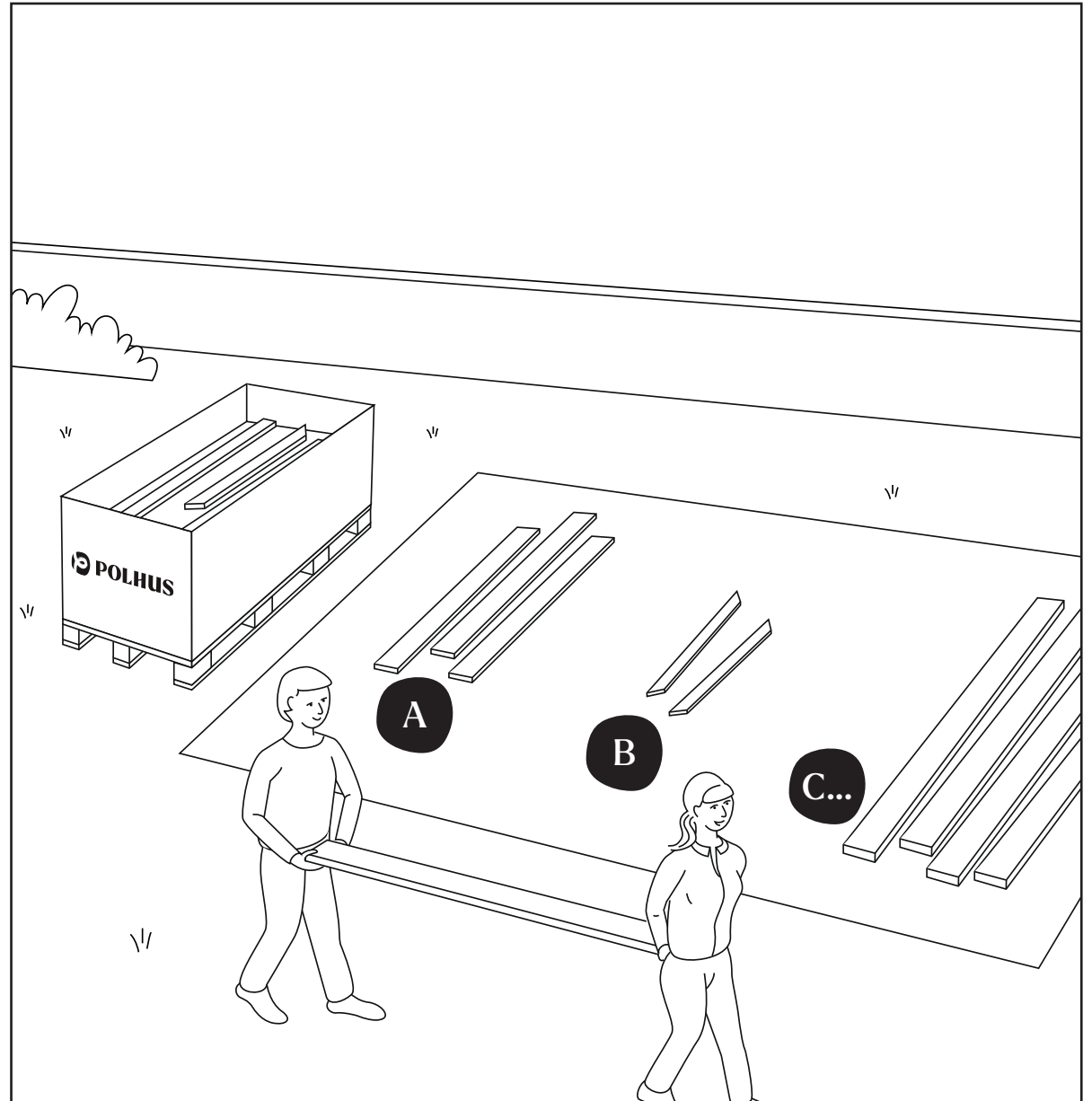
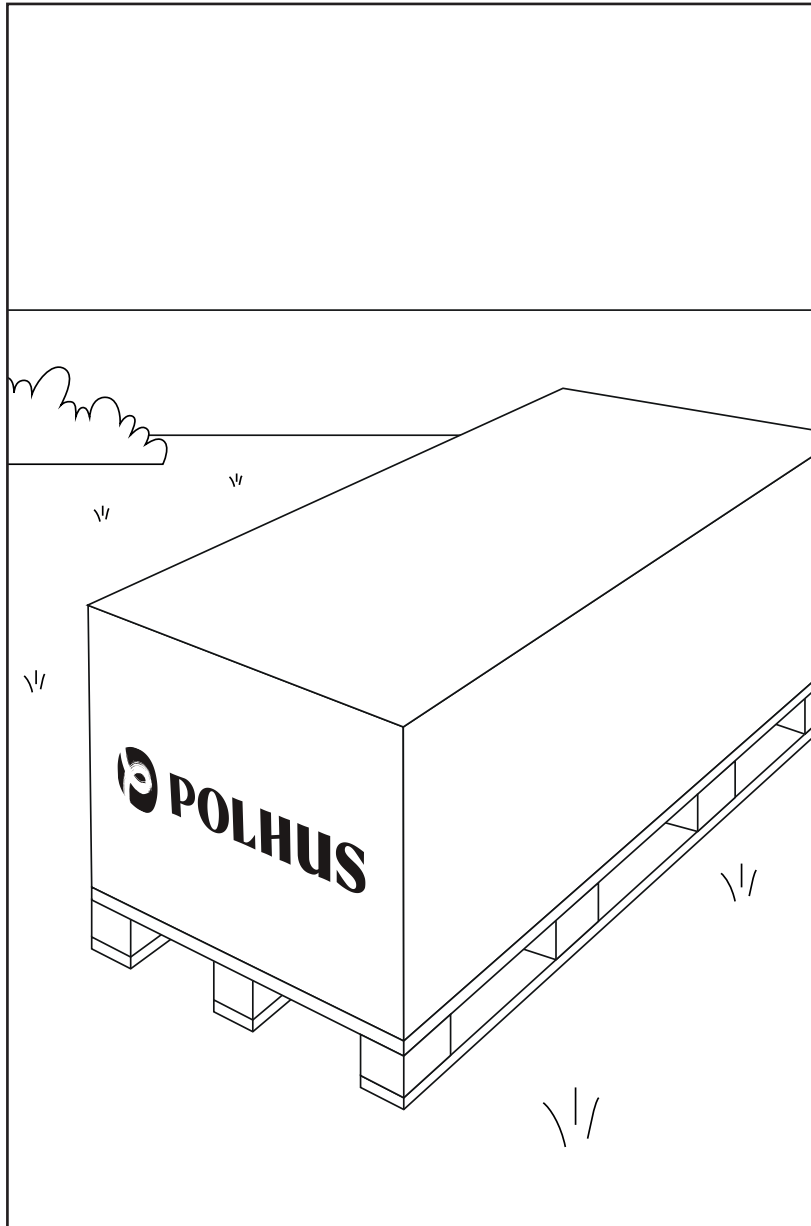



A

W1 
x9 (43x90) x 1972 mm (FBI-2)

W2 
x2 (43x90) x 2350 mm (FBI-1)

B

W3 
x17 +1 (120x28) x 277 mm (T-1 imp)

W4 
x16 +1 (120x28) x 1996 mm (F-1)

C

W5 
x1 (43x43) x 117mm (FS2)

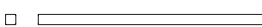
W6 
x1 (43x43) x 1007mm (FS3)

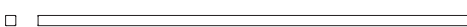
W7 
x3 (43x43) x 1914mm (FS1)

W8 
x15 (135x44) x 200mm (009)

W9 
x15 (135x44) x 1100mm (007)

W10 
x12 (135x44) x 2000mm (006)

W11 
x17 +1 (135x44) x 2088mm (2118 mm) (004 + 001)

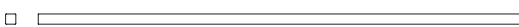
W12 
x2 (43x43) x 2130mm (PN-1)

W13 
x2 (43x43) x 2265mm (PN-2)

W14 
x26 (135x44) x 164mm (010)

W15 
x8 (135x44) x 545mm (008)

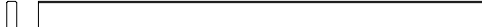
W16 
x2 (135x44) x 2000mm (005)

D

W17 
x2 (135x44) x 2088mm (003/WA-1 & WB-1)

W18 
x2 (135x44) x 670mm (002/WA-1 & WB-1)

W19 
x2 (135x44) x 670mm (002/WA-1 & WB-1)

W20 
x2 (135x44) x 670mm (002/WA-1 & WB-1)

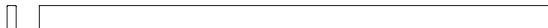
W21 
x2 (140x43) x 2318mm (RB1)

W22 
x21 +1 / (114x18) x 898mm (R-2)
x27 +1 (88x18) x 898mm (R-2)

W23 
x21 +1 / (114x18) x 1746mm (R-1)
x27 +1 (88x18) x 1746mm (R-1)

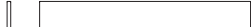
W24 
x2 (120x18) x 905mm (GB-1)

W25 
x2 (120x18) x 1747mm (GB-2)

W26 
x2 (43x43) x 2318mm (ES-1)

W27 
x2 (120x18) x 2354mm (EB-1)

E

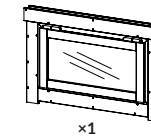

x1

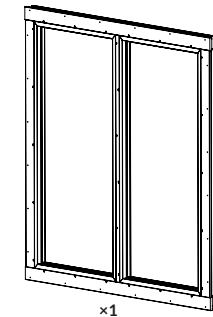

x1

F

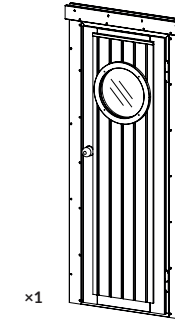

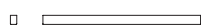

x1

W28 
x1 (28x48) x 700mm (SWE-1)

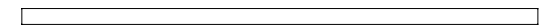
G

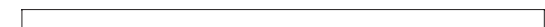
W29 
x2 (70x18) x 2265mm (TBE7-2)

W30 
x2 (90x18) x 2295mm (TBE8-2)

W31 
x2 (90x18) x 2160mm (TBE8-1)

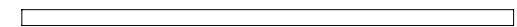
W32 
x2 (70x18) x 2160mm (TBE7-1)

H

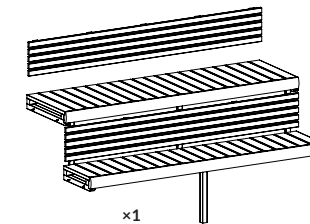

x1

W33 
x3 (43x43) x 1914mm (PF-1)

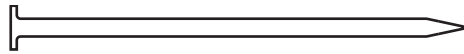

60 mm ×380

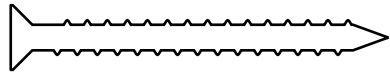

50 mm ×154

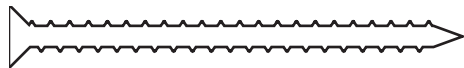

60 mm ×239



80 mm ×244

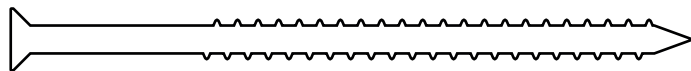

90 mm ×50

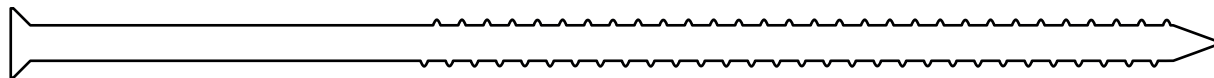

160 mm ×121

1:1



=

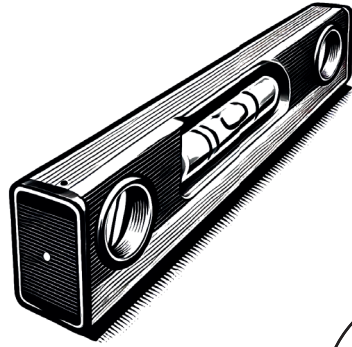
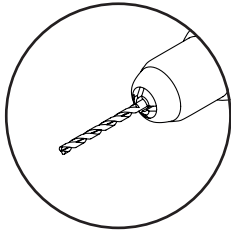

=

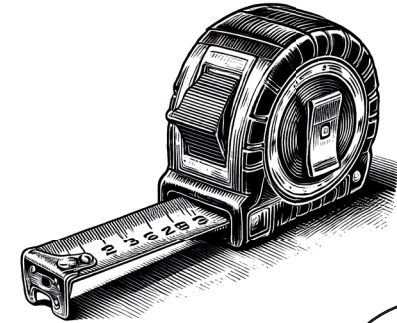
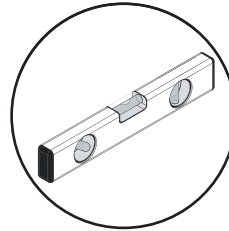

=

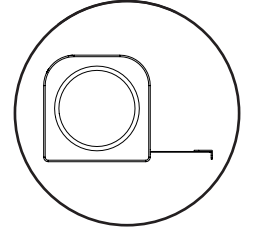

=

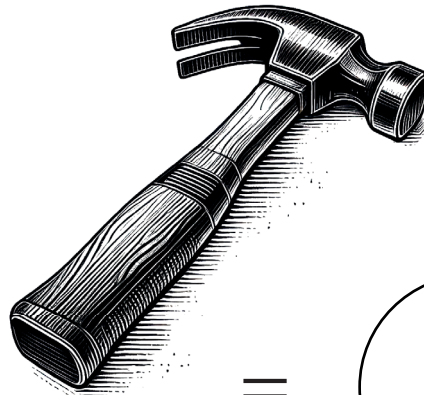
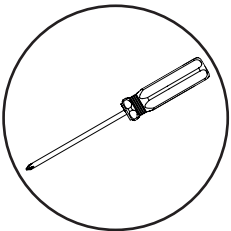

=

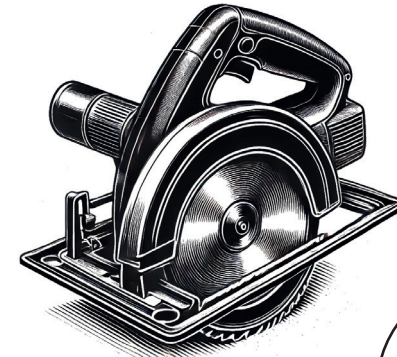
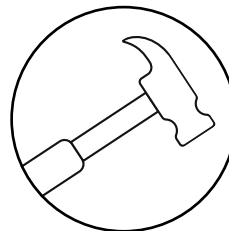

=

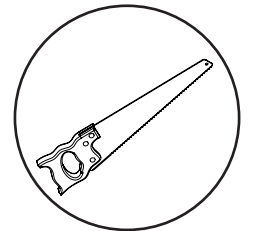

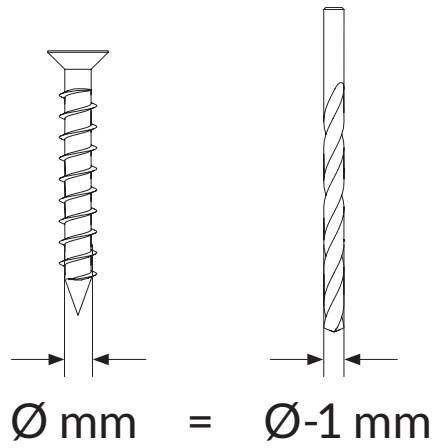
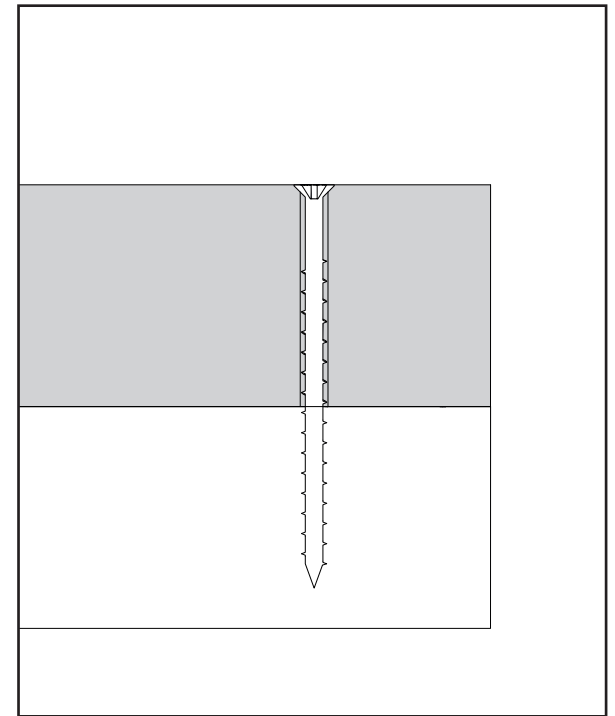
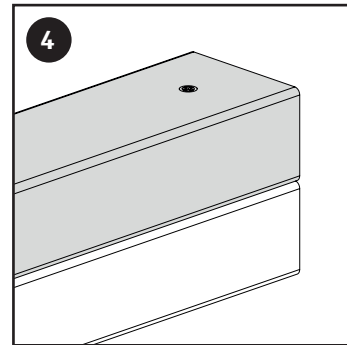
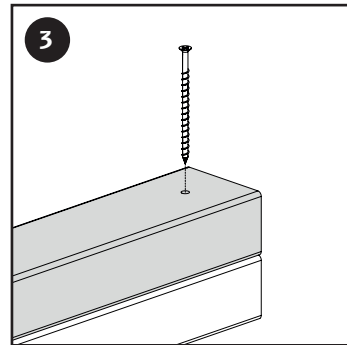
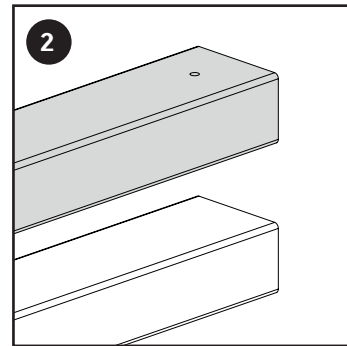
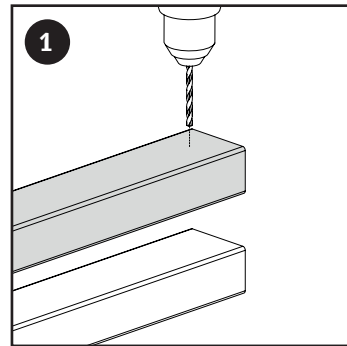
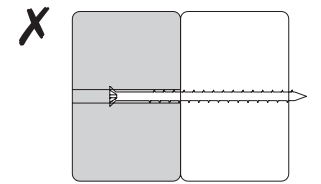
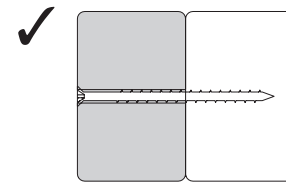
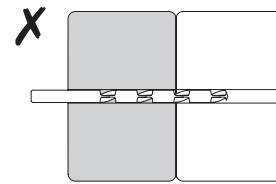
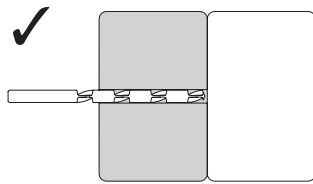
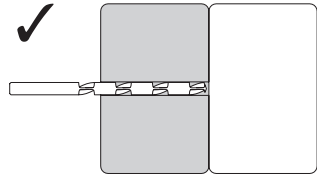
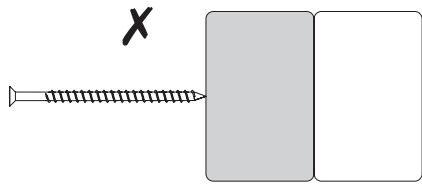

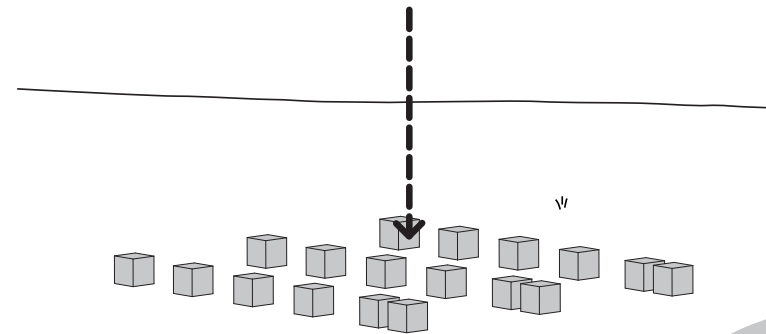
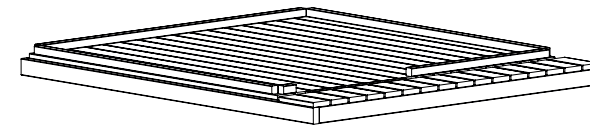
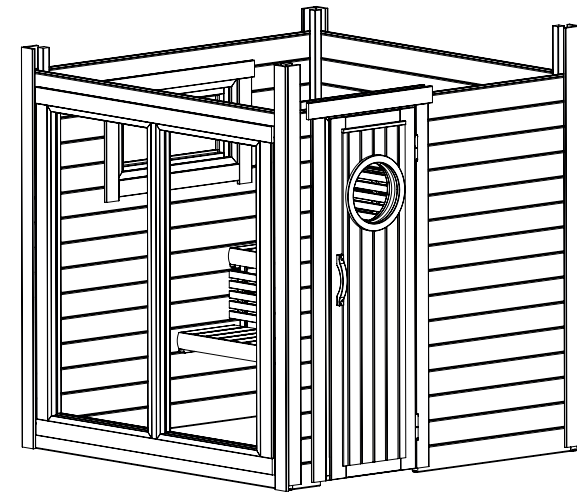
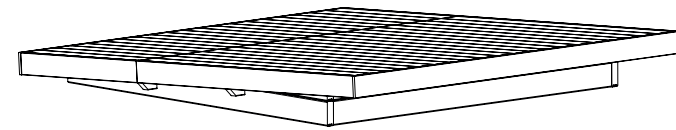
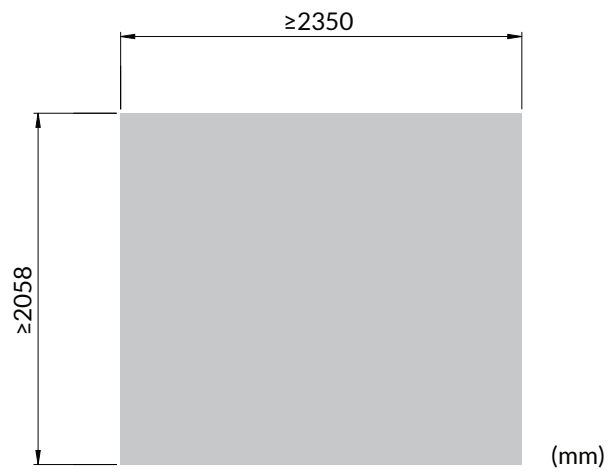
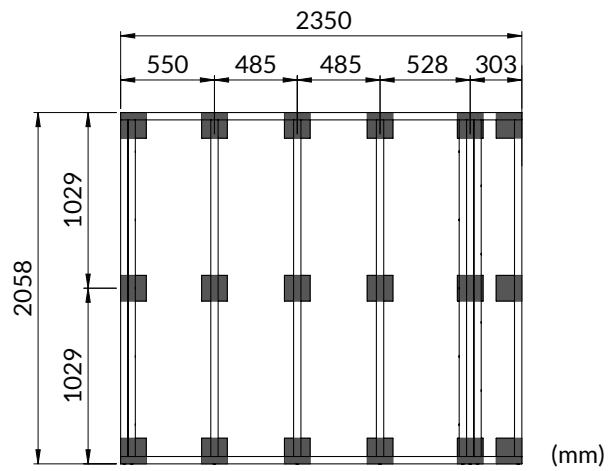

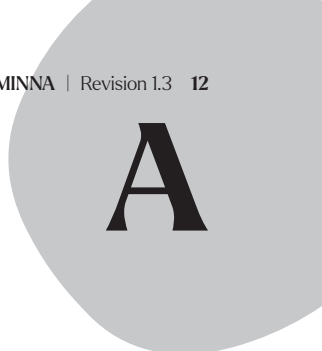

A

W1 
×9 (43×90) × 1972 mm (FBI-2)

W2 
×2 (43×90) × 2350 mm (FBI-1)

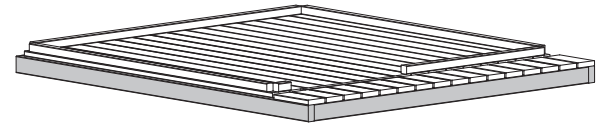
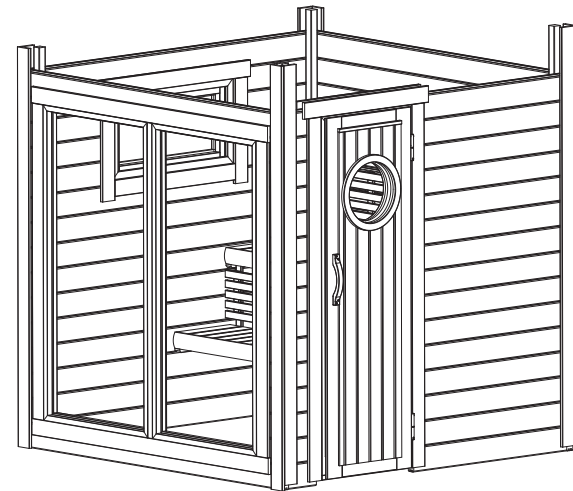

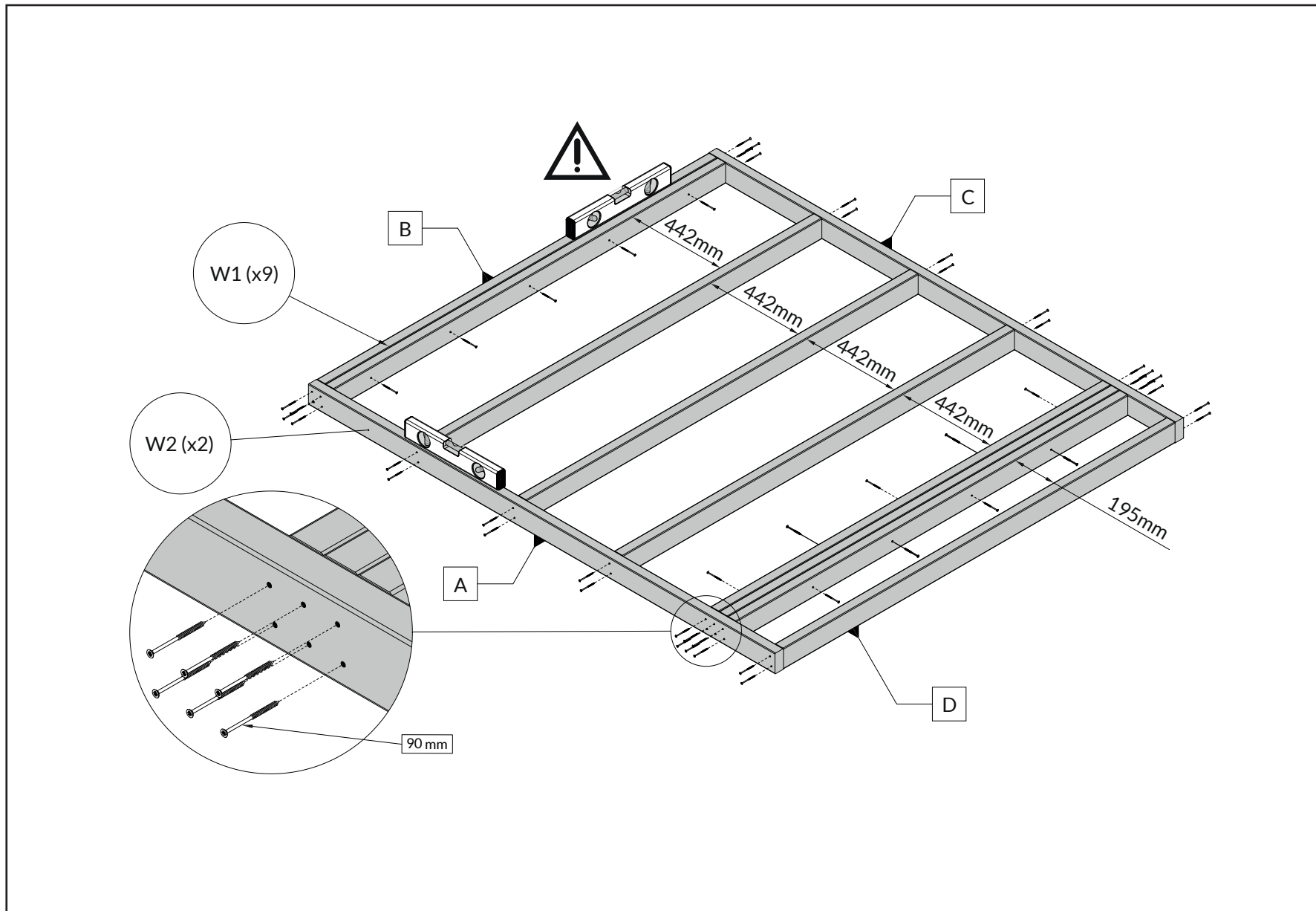

- W1 x9
- W2 x2

90mm x50

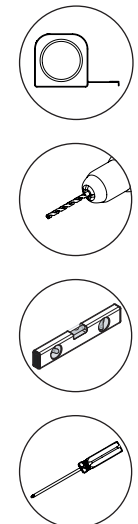

A|1→ B|1→ C|1→2→3→4→ D|1→2→3→4→5→6→7→8→9→
 E|1→2→ F|1→2→3→ G|1→ H|1→2

A1

B

W3 
x17 (120x28) x 277 mm (T-1 imp)

W4 
x16 (120x28) x 1996 mm (F-1)

60mm

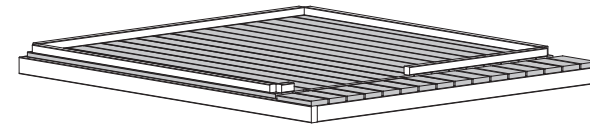
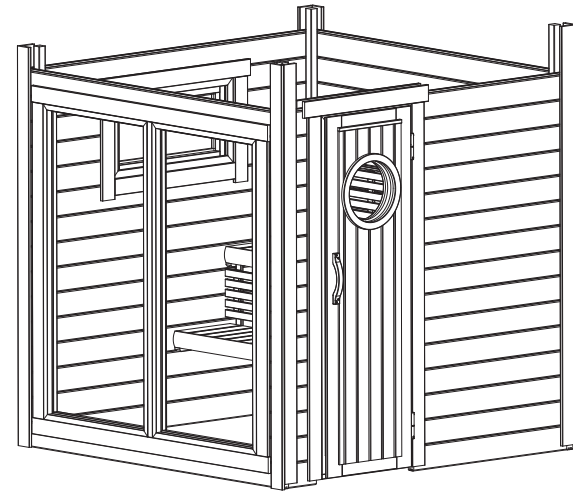
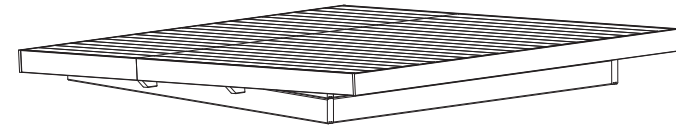

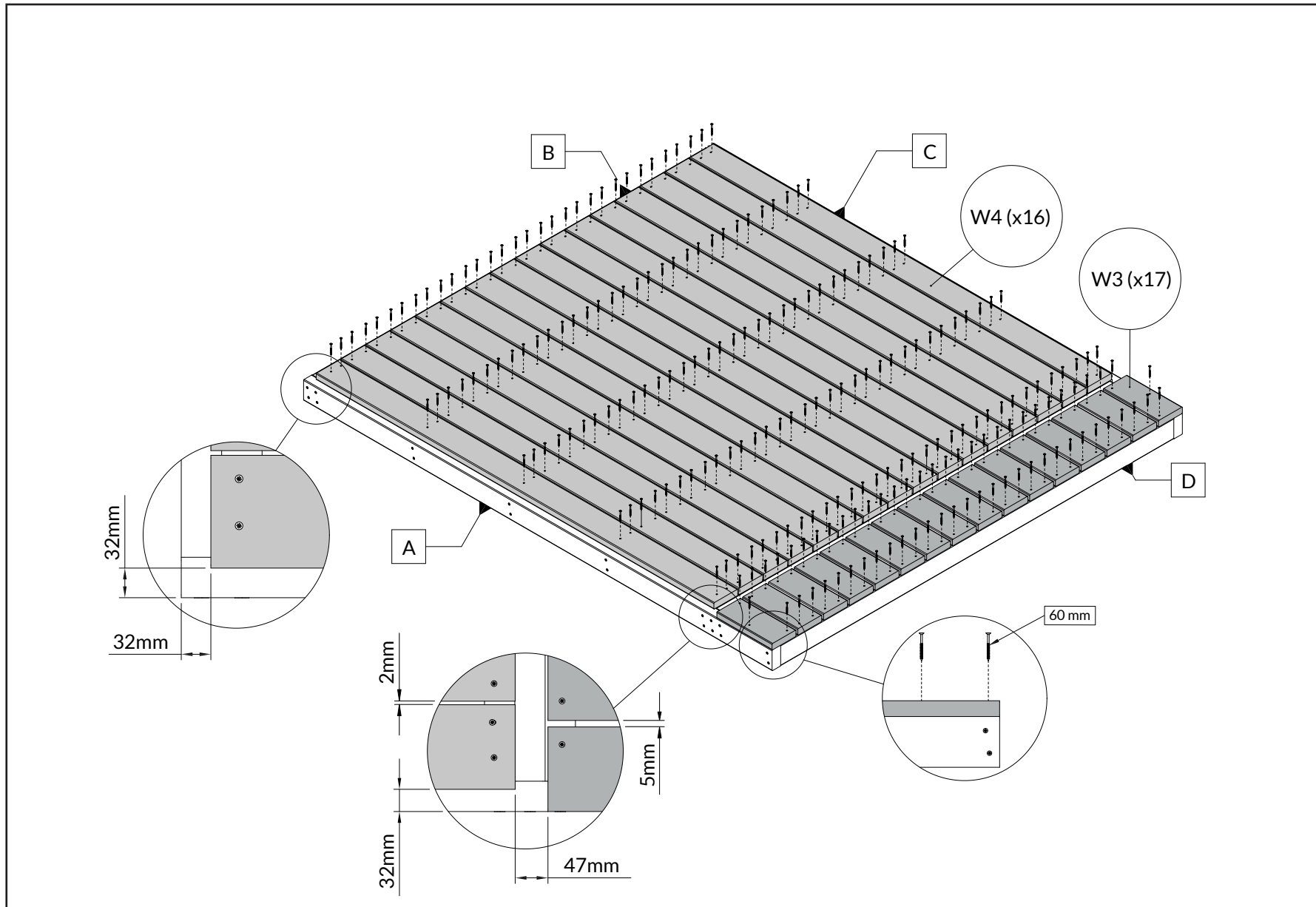

W3 x17

W4 x16



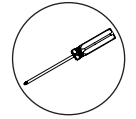
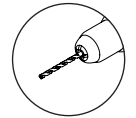
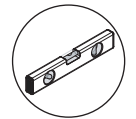







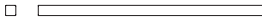

60mm x226



A|1→ B|1→ C|1→2→3→4→ D|1→2→3→4→5→6→7→8→9→
 E|1→2→ F|1→2→3→ G|1→ H|1→2

B1

C

- W5**  
 ×1 (43x43) × 117mm (FS2)
- W6** 
 ×1 (43x43) × 1007mm (FS3)
- W7** 
 ×3 (43x43) × 1914mm (FS1)
- W8** 
 ×15 (135x44) × 200mm (009)
- W9** 
 ×15 (135x44) × 1100mm (007)
- W10** 
 ×12 (135x44) × 2000mm (006)
- W11** 
 ×17 (135x44) × 2088mm (2118 mm) (004)
- W12** 
 ×2 (43x43) × 2130mm (PN-1)
- W13** 
 ×2 (43x43) × 2265mm (PN-2)
- W14** 
 ×26 (135x44) × 164mm (010)
- W15** 
 ×8 (135x44) × 545mm (008)
- W16** 
 ×2 (135x44) × 2000mm (005)

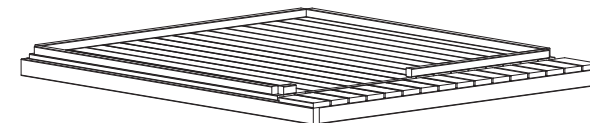
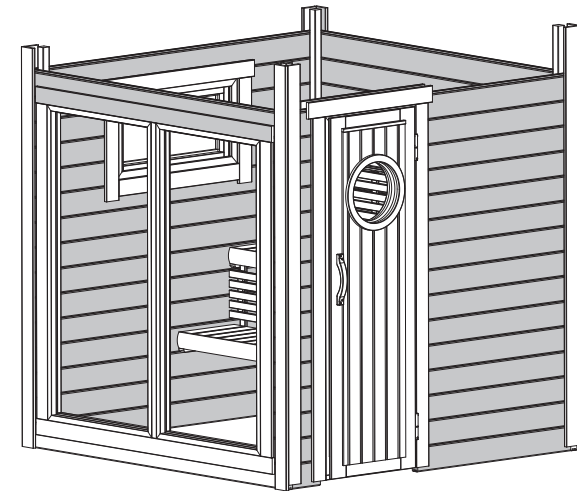

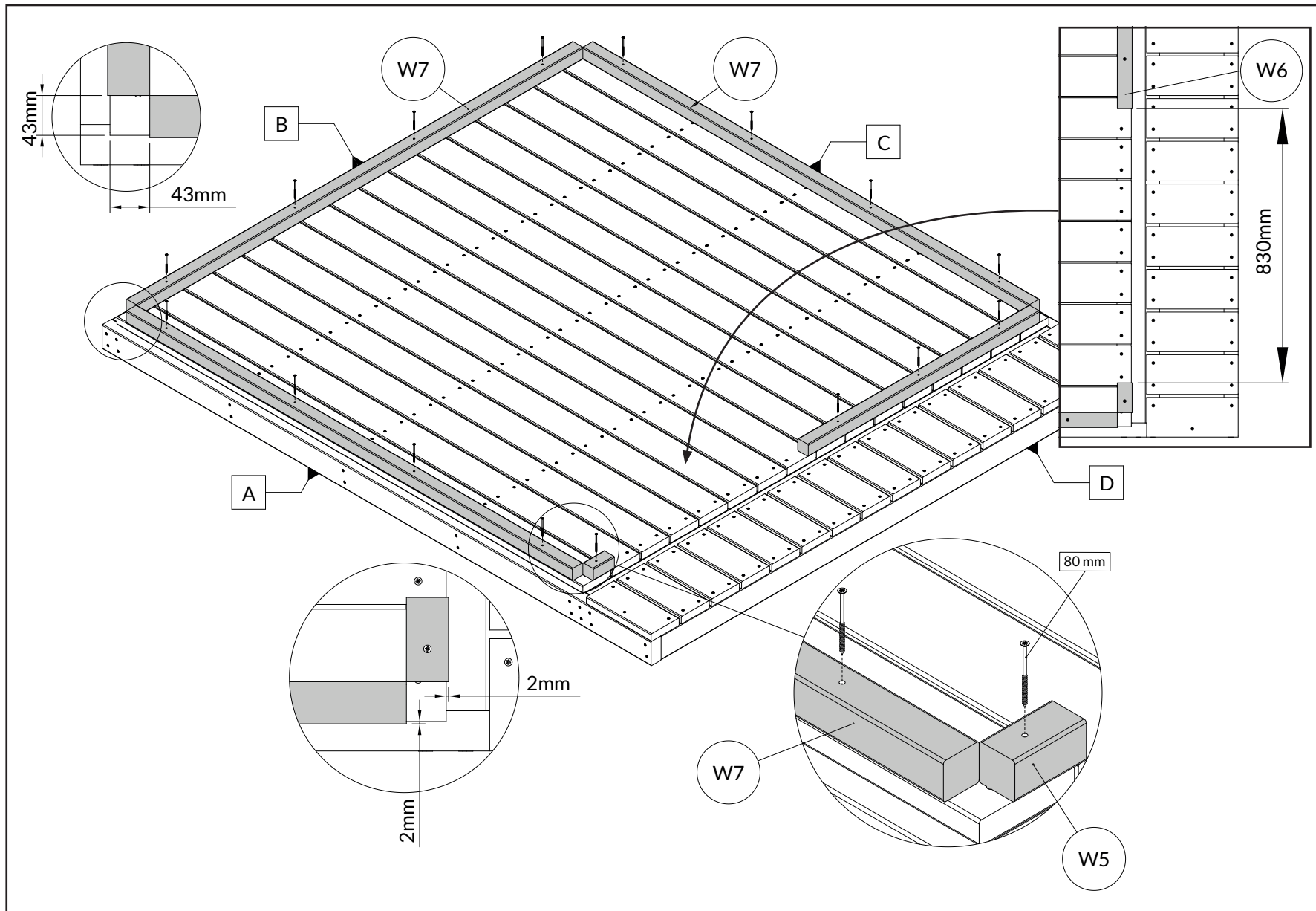

- W5 x1
- W6 x1
- W7 x3

80mm x16

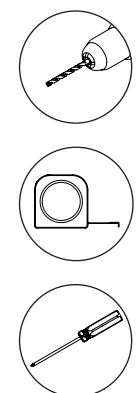

A|1→ B|1→ C|1→2→3→4→ D|1→2→3→4→5→6→7→8→9→
 E|1→2→ F|1→2→3→ G|1→ H|1→2

C1

C2

A|1→ B|1→ C|1→2→3→4→ D|1→2→3→4→5→6→7→8→9→
 E|1→2→ F|1→2→3→ G|1→ H|1→2

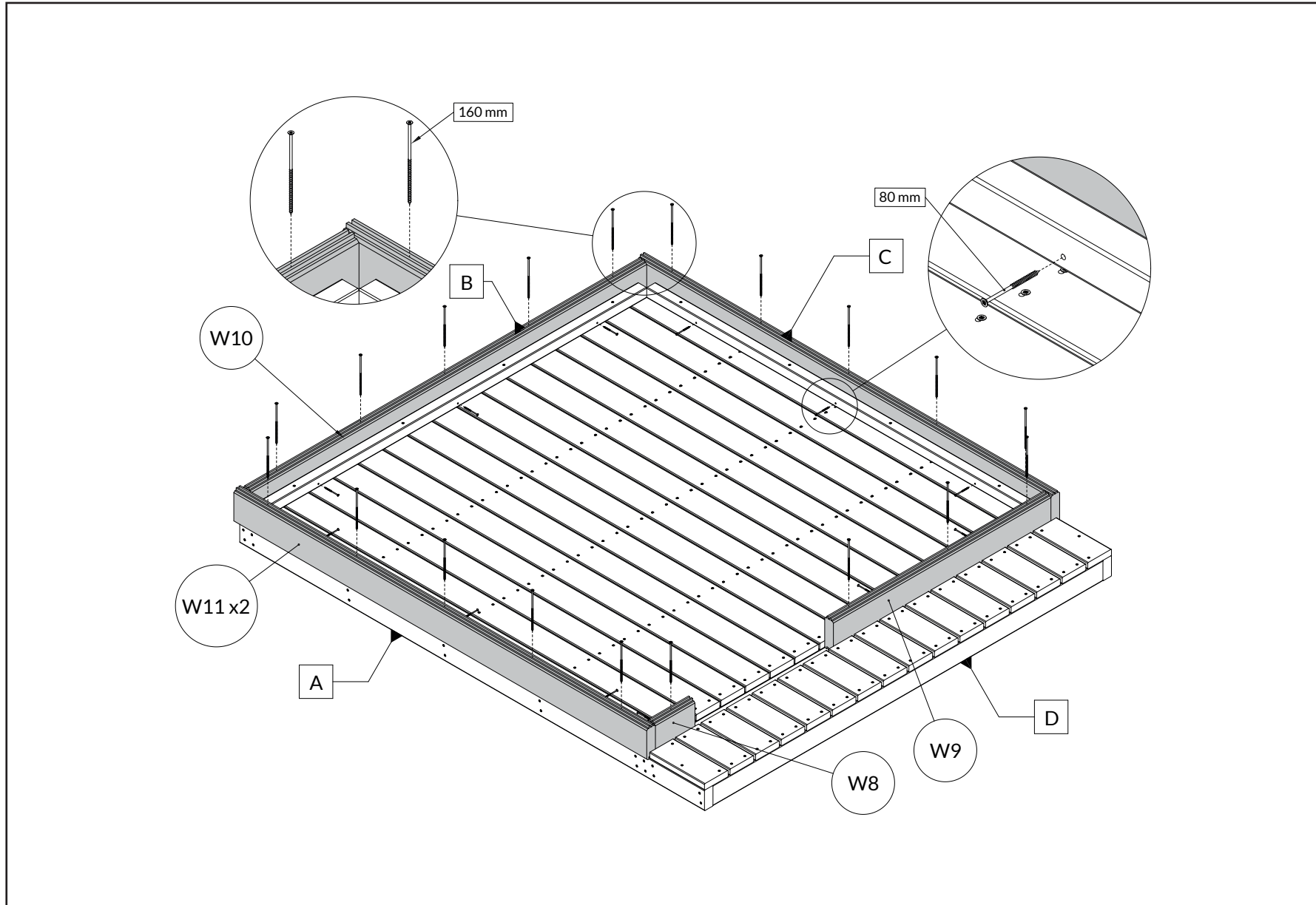

- W8 x1
- W9 x1
- W10 x1
- W11 x2

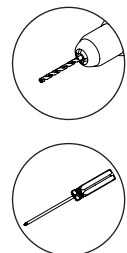
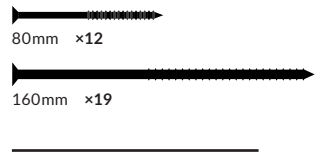

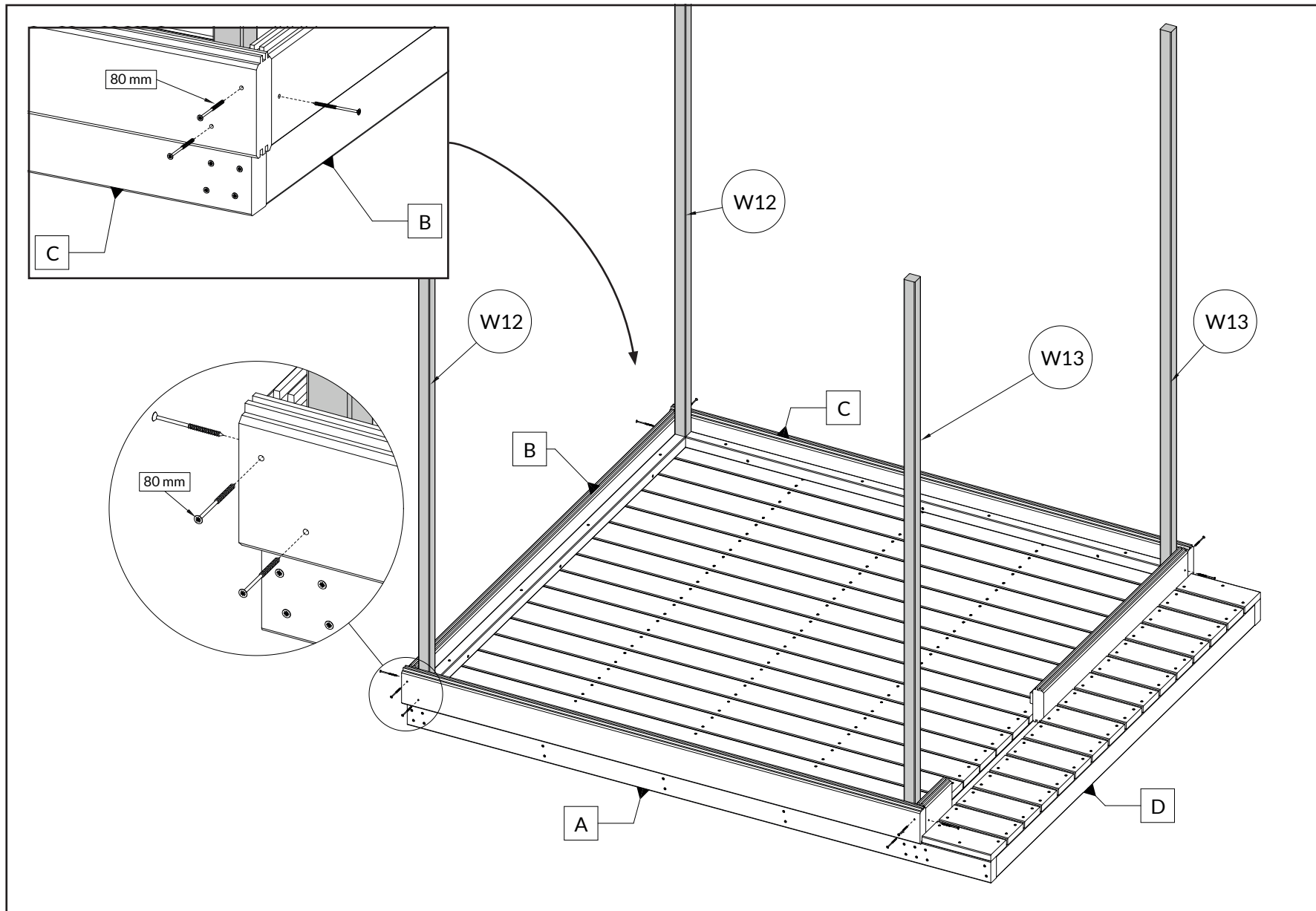

W12 x2

W13 x2

80mm x12

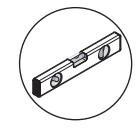
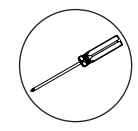
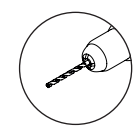

A|1→ B|1→ C|1→2→3→4→ D|1→2→3→4→5→6→7→8→9→
 E|1→2→ F|1→2→3→ G|1→ H|1→2

C3

C4

A|1→ B|1→ C|1→2→3→4→ D|1→2→3→4→5→6→7→8→9→
E|1→2→ F|1→2→3→ G|1→ H|1→2

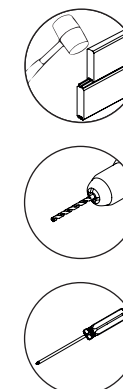
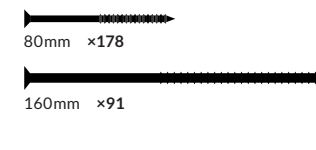
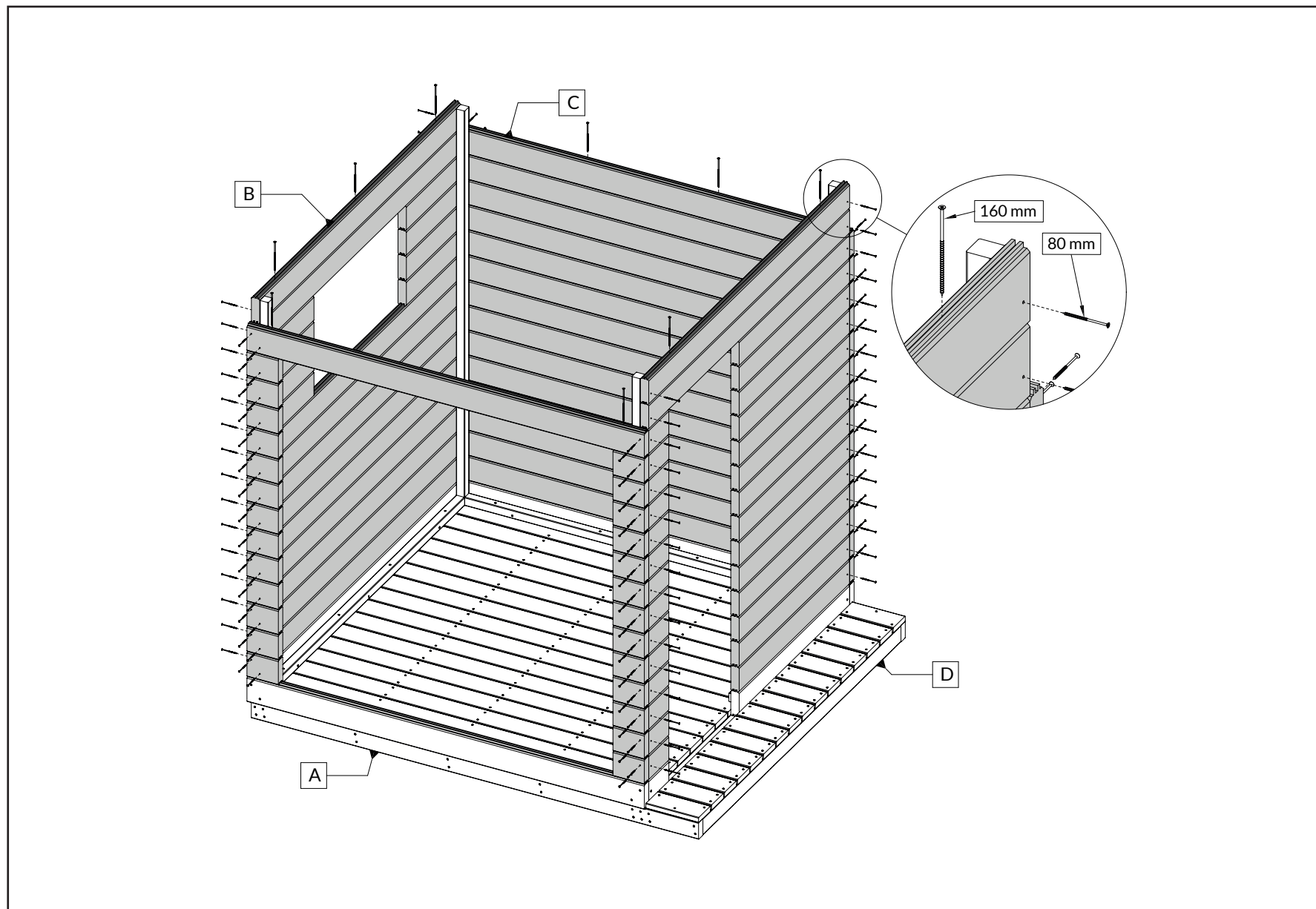

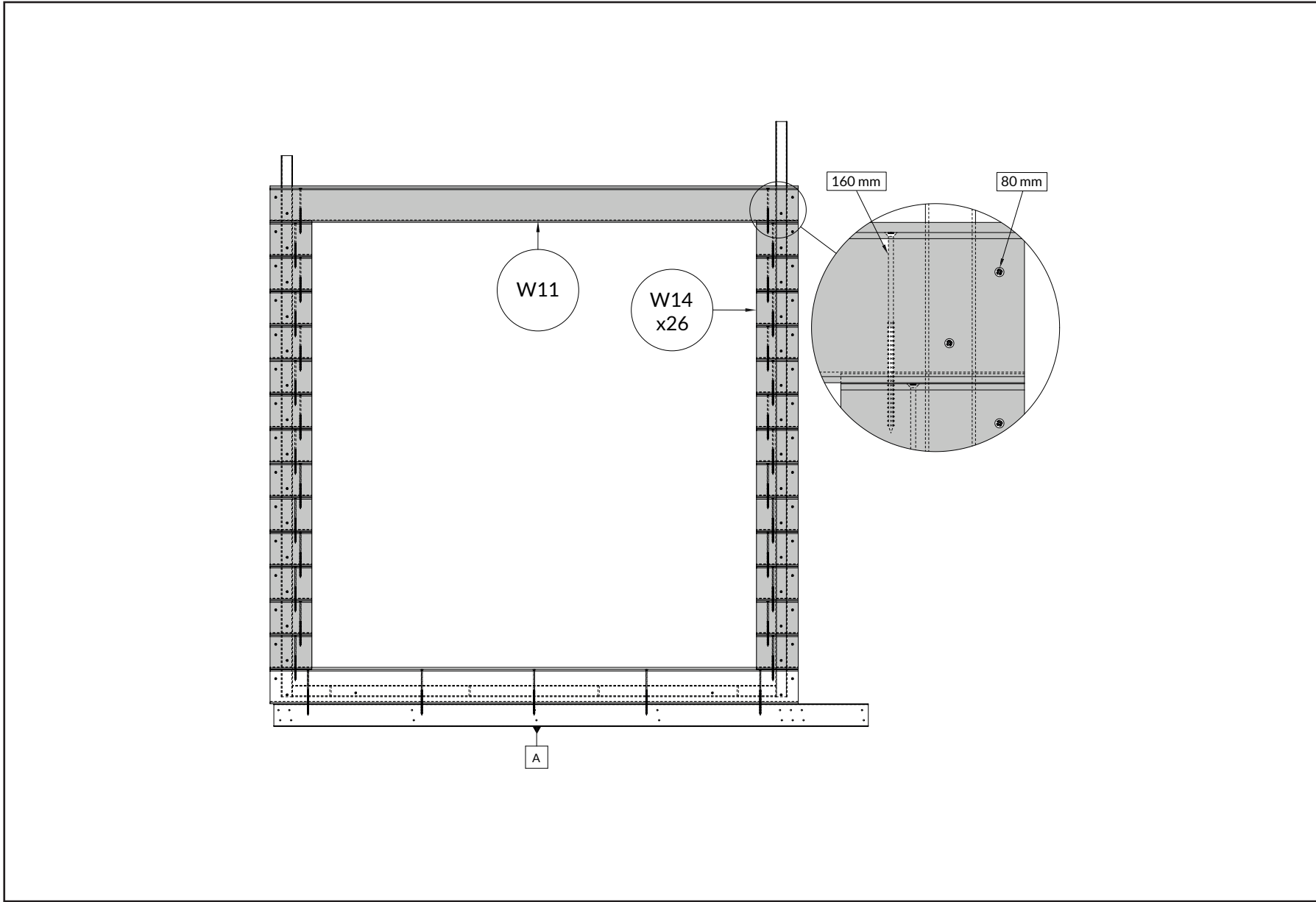

W14 x26

W11 x1

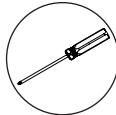
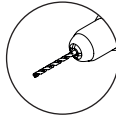

A|1→ B|1→ C|1→2→3→4→ D|1→2→3→4→5→6→7→8→9→
 E|1→2→ F|1→2→3→ G|1→ H|1→2

C4.1

C4.2

A|1→ B|1→ C|1→2→3→4→ D|1→2→3→4→5→6→7→8→9→
E|1→2→ F|1→2→3→ G|1→ H|1→2

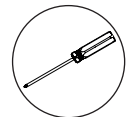
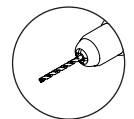
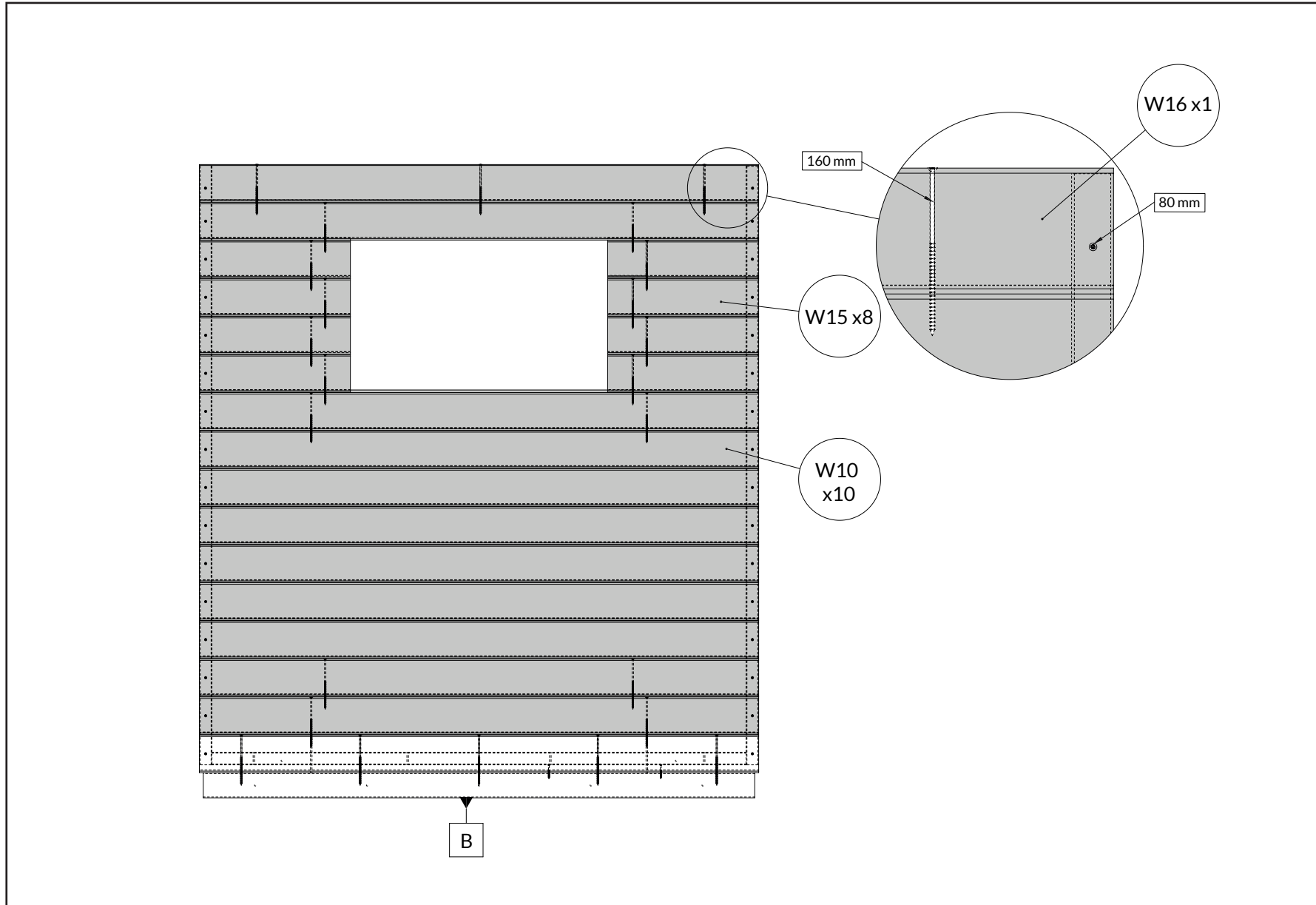

W11 x14

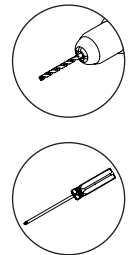
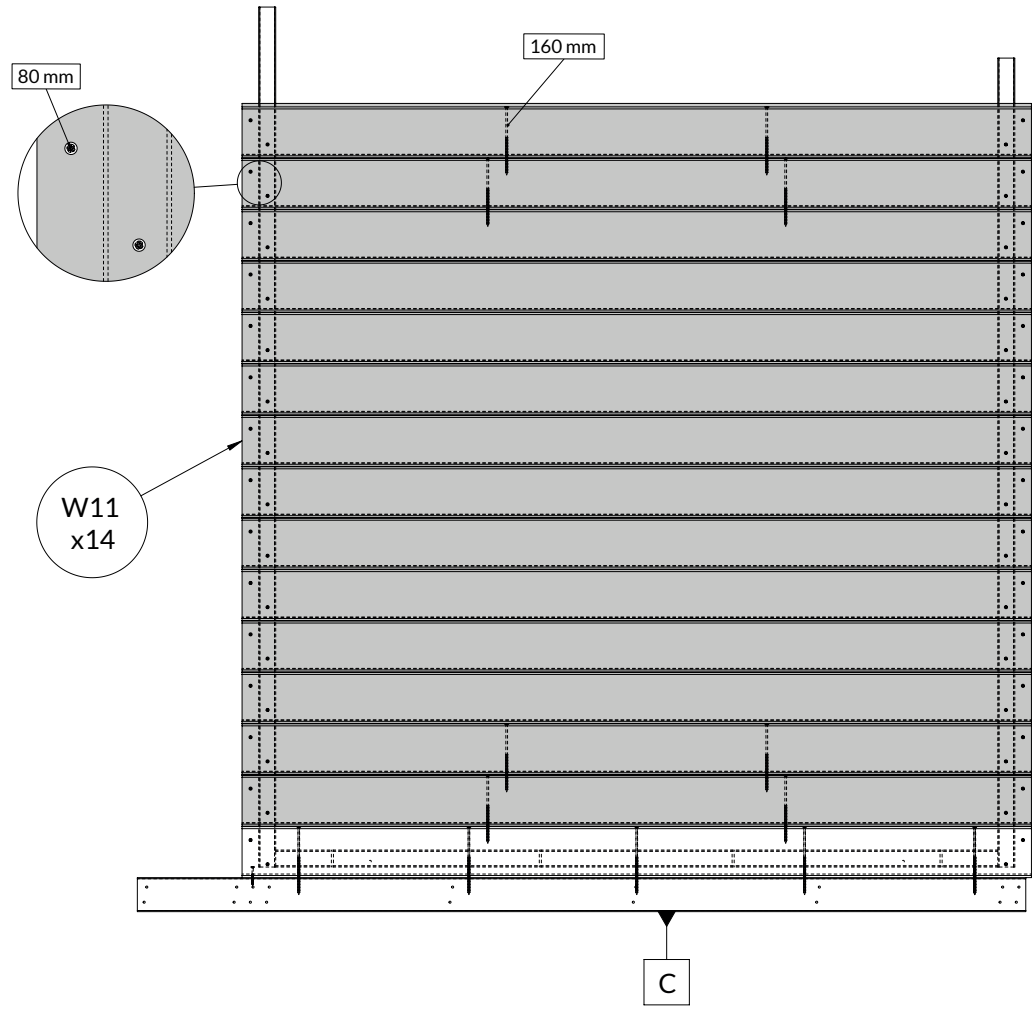

A|1→ B|1→ C|1→2→3→4→ D|1→2→3→4→5→6→7→8→9→
E|1→2→ F|1→2→3→ G|1→ H|1→2

C4.3

C4.4

A|1→ B|1→ C|1→2→3→4→ D|1→2→3→4→5→6→7→8→9→
E|1→2→ F|1→2→3→ G|1→ H|1→2

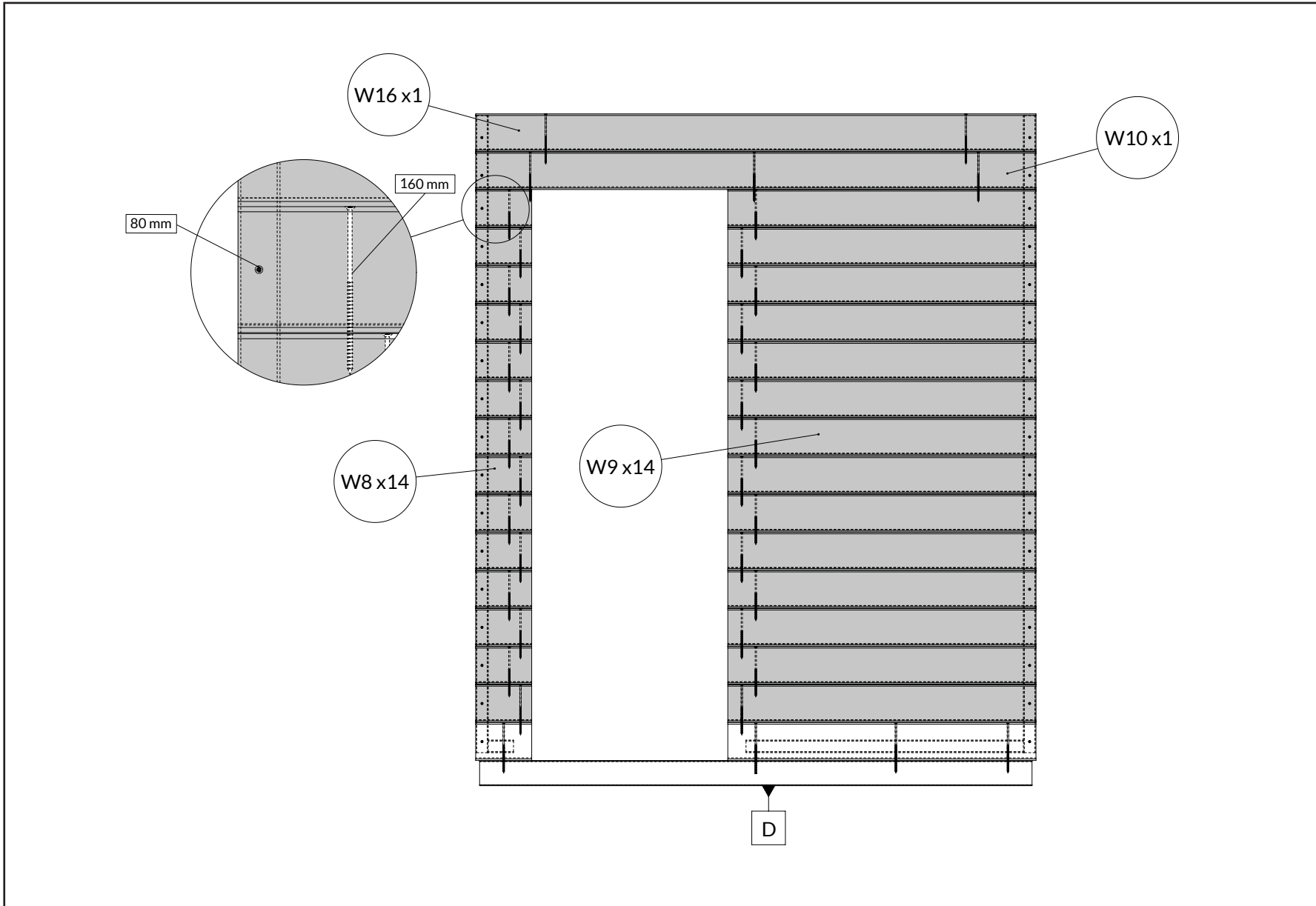

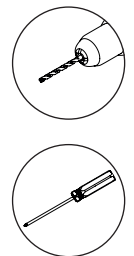

- W8 x14
- W9 x14
- W10 x1
- W16 x1





D

- W17** 

 ×2 (135×44) × 2088mm (003)
- W18** 

 ×2 (135×44) × 670mm (002/WA-1 & WB-1)
- W19** 

 ×2 (135×44) × 670mm (002/WA-1 & WB-1)
- W20** 

 ×2 (135×44) × 670mm (002/WA-1 & WB-1)
- W21** 

 ×2 (140×43) × 2318mm (RB1)
- W22** 

 ×21/
 ×27 (114×18) × 898mm (R-2)
 (88×18) × 898mm (R-2)
- W23** 

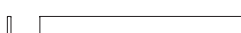

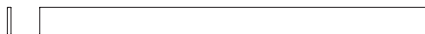

 ×21/
 ×27 (114×18) × 1746mm (R-1)
 (88×18) × 1746mm (R-1)
- W24** 

 ×2 (120×16) × 905mm (GB-1)
- W25** 

 ×2 (120×16) × 1747mm (GB-2)
- W26** 

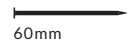
 ×2 (43×43) × 2318mm (ES-1)
- W27** 

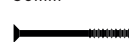
 ×2 (120×16) × 2354mm (EB-1)

-  60mm
-  50mm
-  80mm
-  160mm

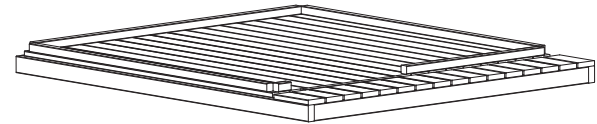
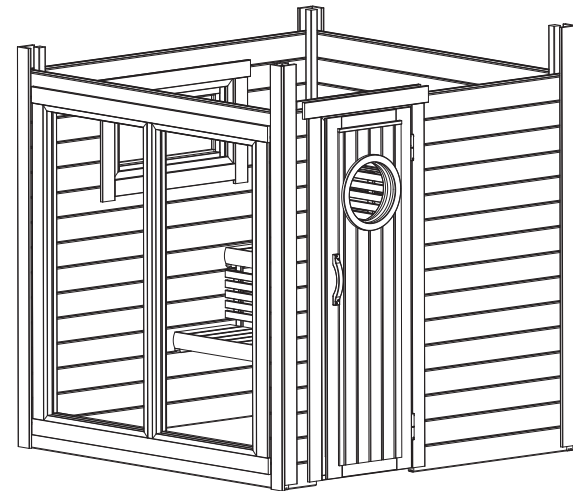
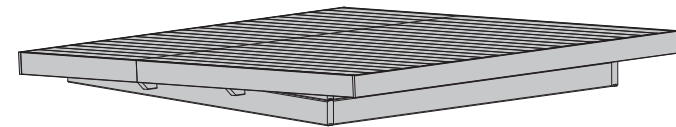

D1

A|1→ B|1→ C|1→2→3→4→ D|1→2→3→4→5→6→7→8→9→
E|1→2→ F|1→2→3→ G|1→ H|1→2

W17 x2

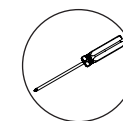
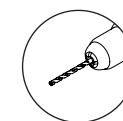
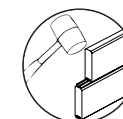
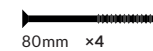
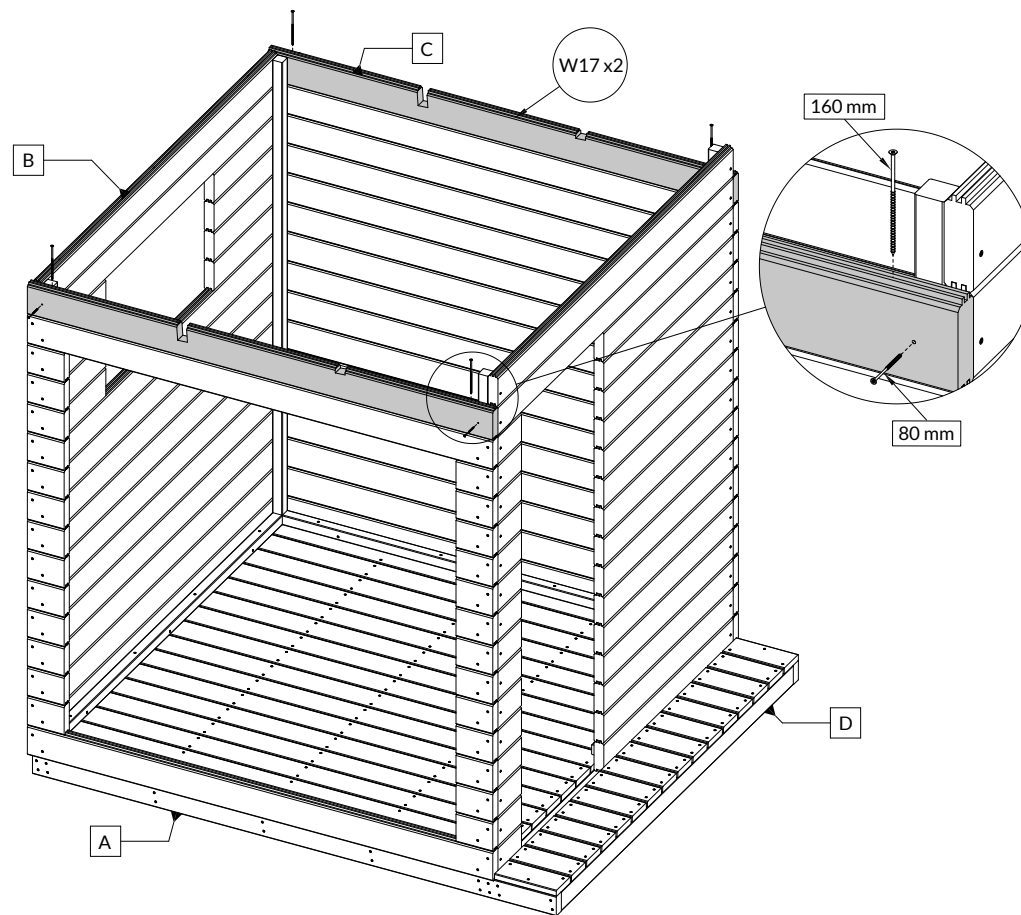

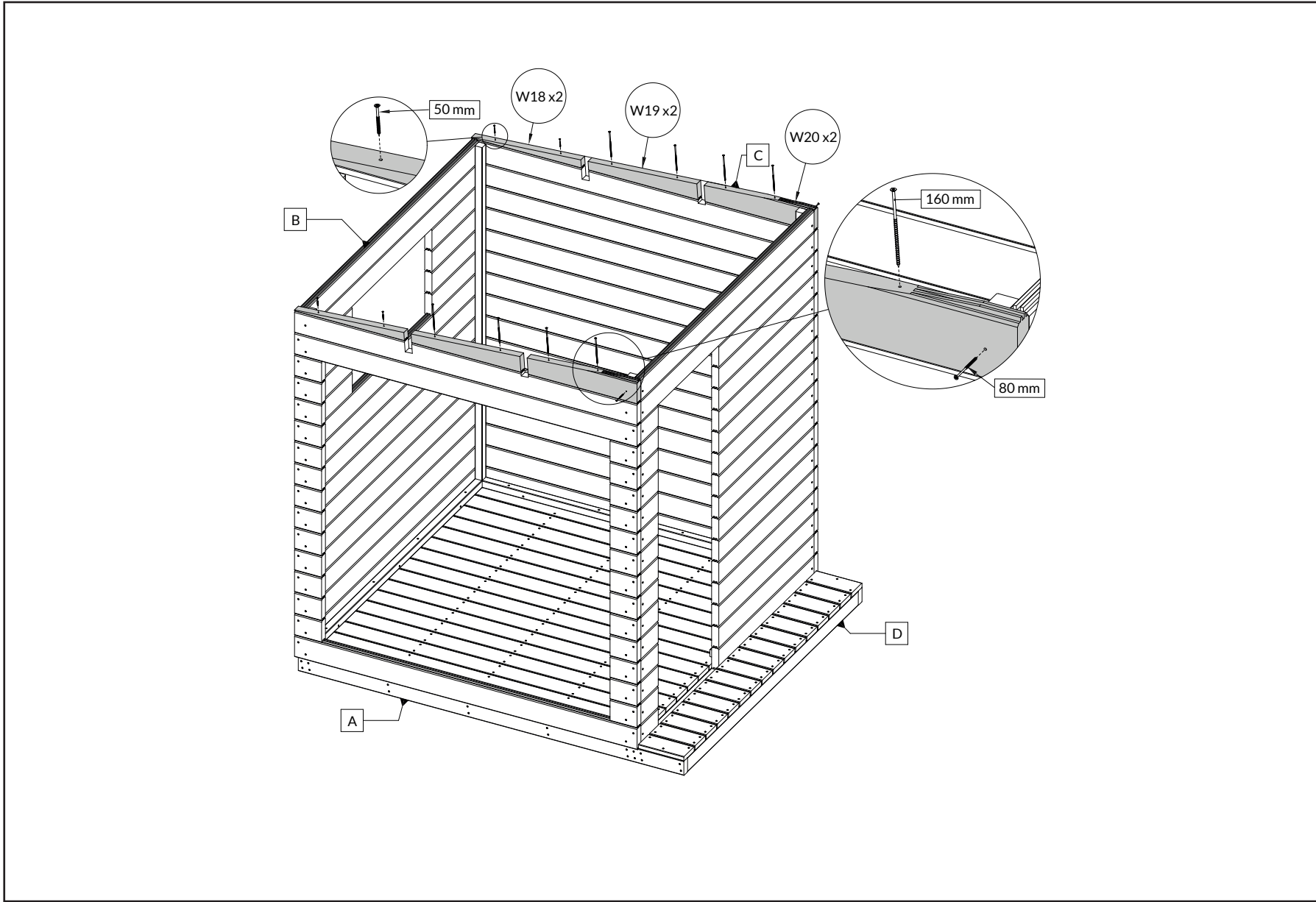

W18 x2

W19 x2

W20 x2

50mm x4

80mm x2

160mm x8

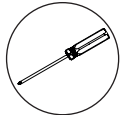
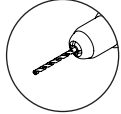
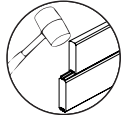

A|1→ B|1→ C|1→2→3→4→ D|1→2→3→4→5→6→7→8→9→
 E|1→2→ F|1→2→3→ G|1→ H|1→2

D2

D3

A|1→ B|1→ C|1→2→3→4→ D|1→2→3→4→5→6→7→8→9→
E|1→2→ F|1→2→3→ G|1→ H|1→2

W21 x2

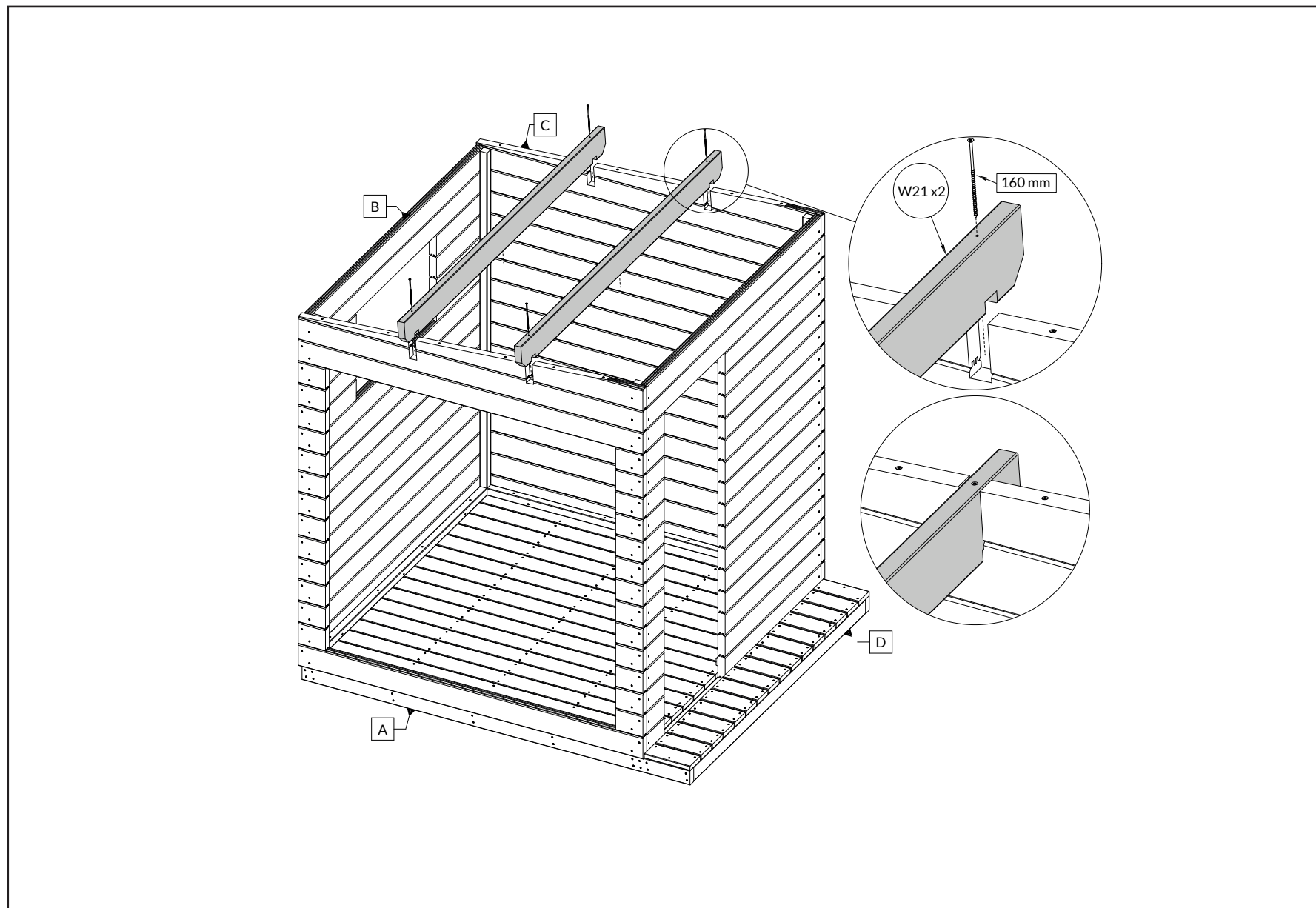

160mm x4

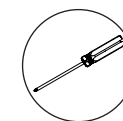
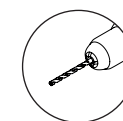
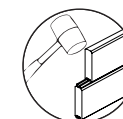



X= 114 / 88 mm

W22 x21 / x27

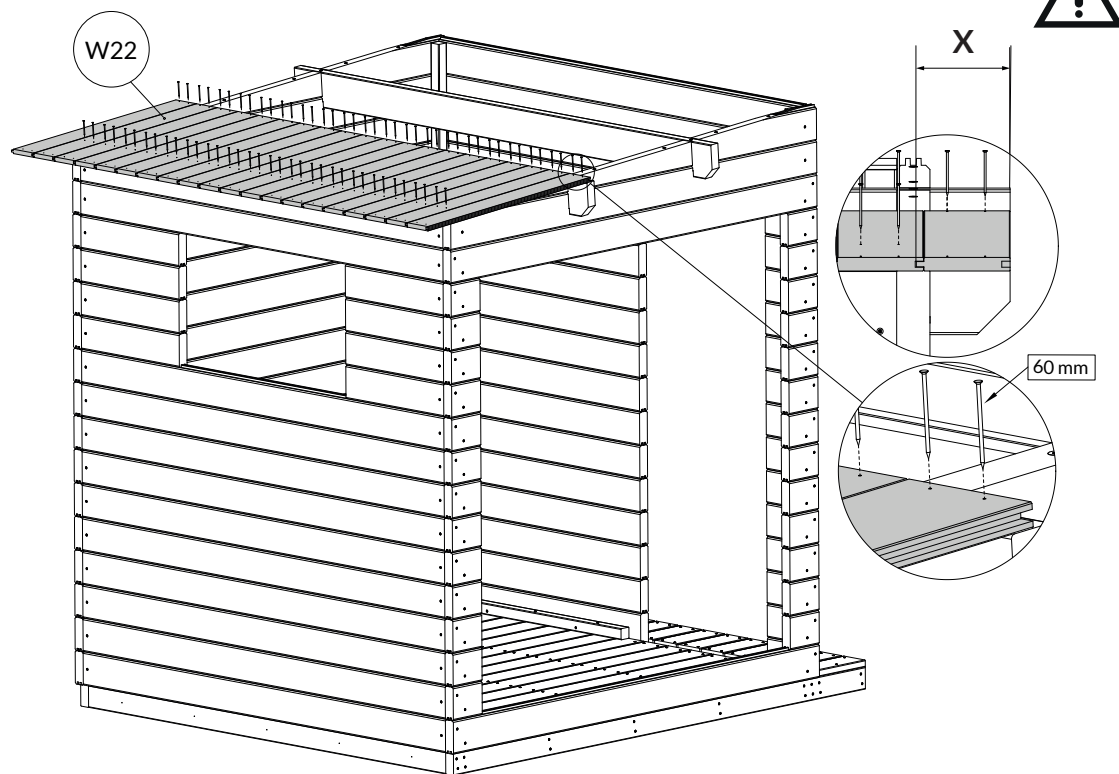

60mm

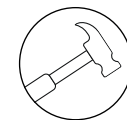
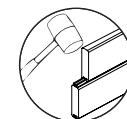

A|1→ B|1→ C|1→2→3→4→ D|1→2→3→4→5→6→7→8→9→
E|1→2→ F|1→2→3→ G|1→ H|1→2

D4

D5



X= 114 / 88 mm

W23 x21 / x27

A|1→ B|1→ C|1→2→3→4→ D|1→2→3→4→5→6→7→8→9→
E|1→2→ F|1→2→3→ G|1→ H|1→2

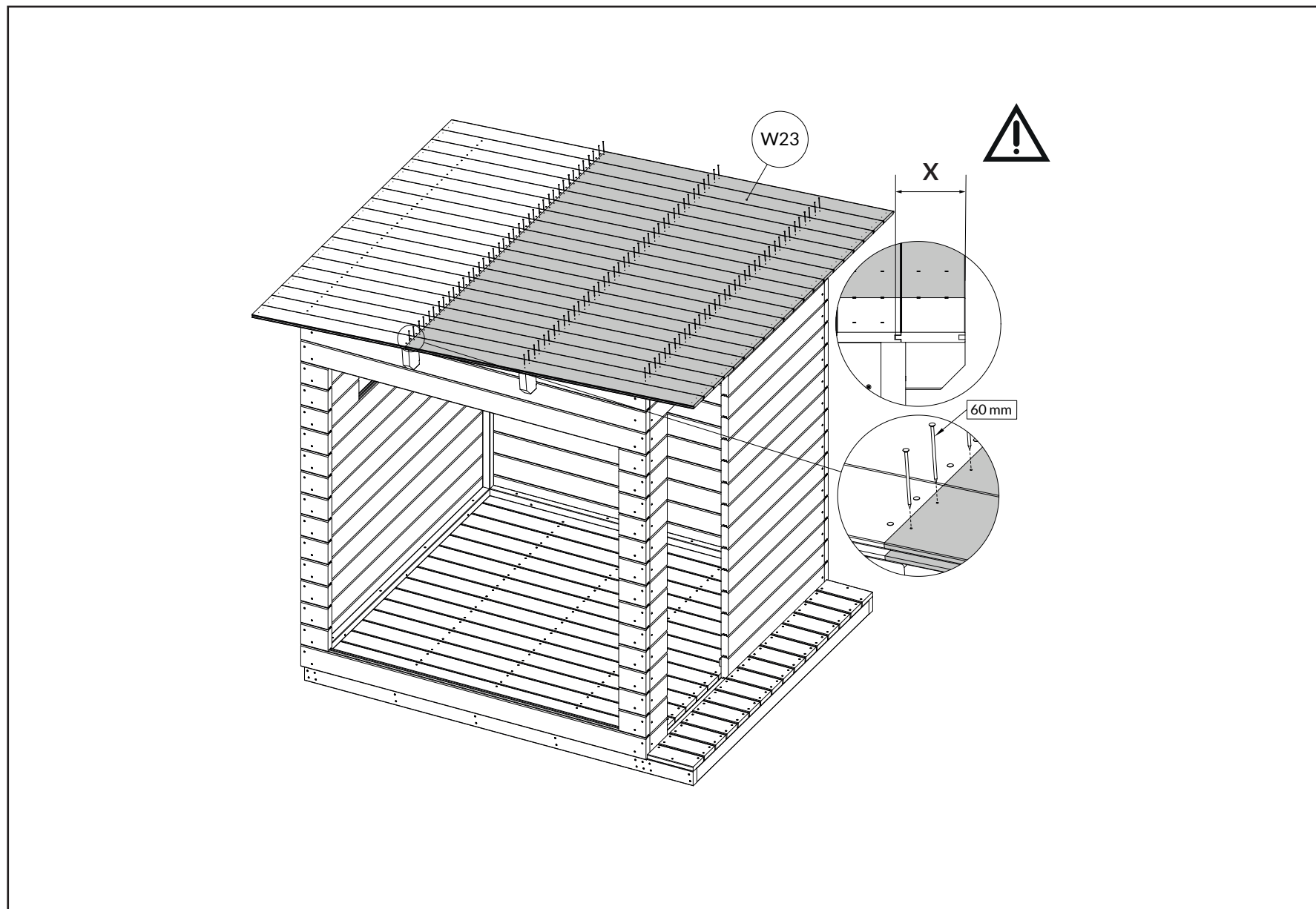

60mm

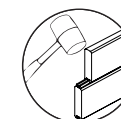

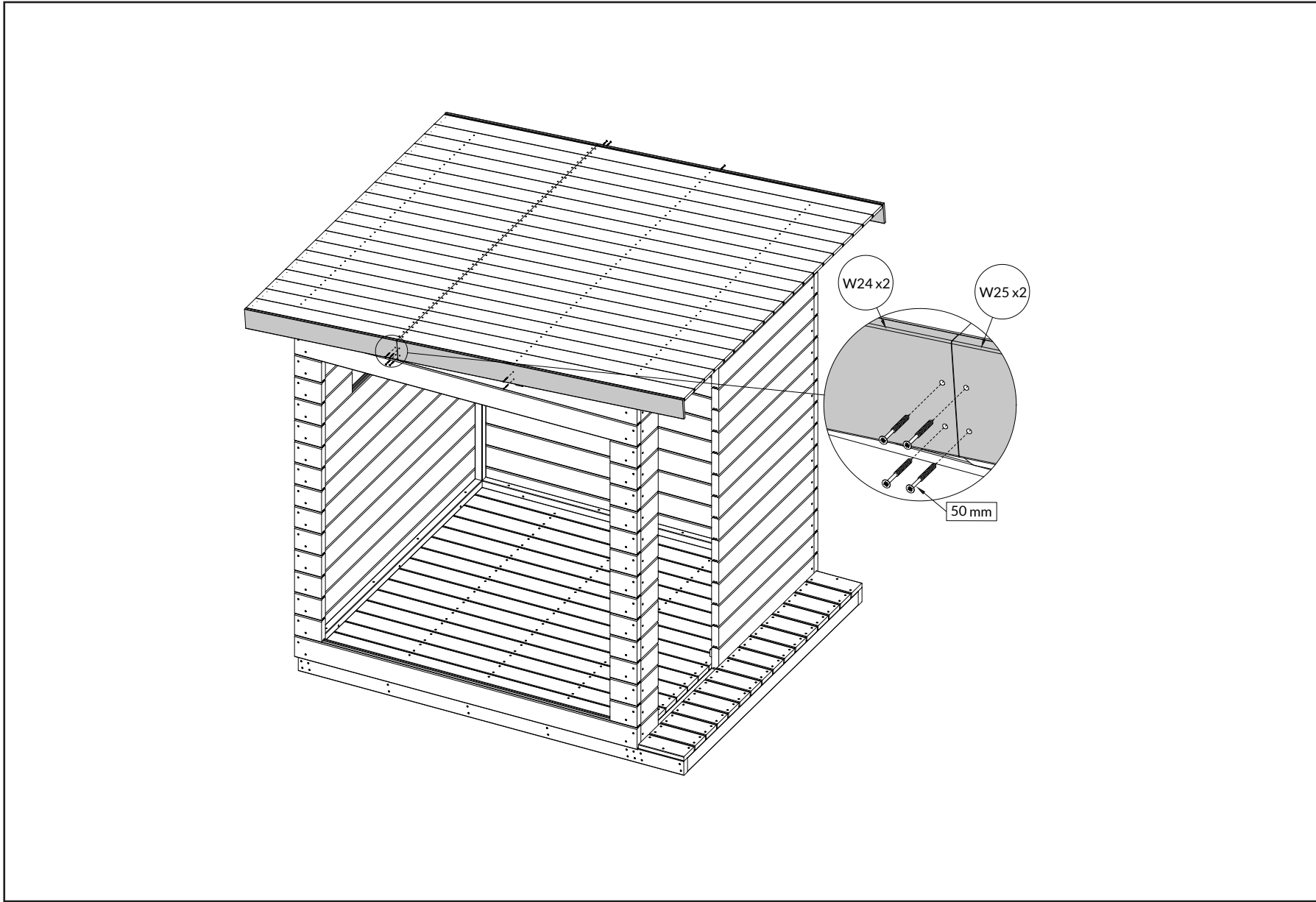

W24 x2

W25 x2

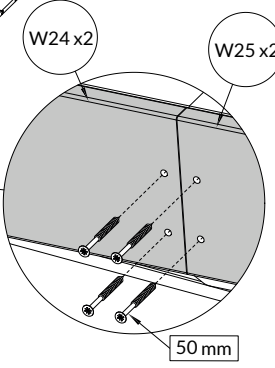

50mm x12

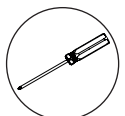
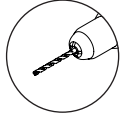

A|1→ B|1→ C|1→2→3→4→ D|1→2→3→4→5→6→7→8→9→
 E|1→2→ F|1→2→3→ G|1→ H|1→2

D6

D7

A|1→ B|1→ C|1→2→3→4→ D|1→2→3→4→5→6→7→8→9→
E|1→2→ F|1→2→3→ G|1→ H|1→2

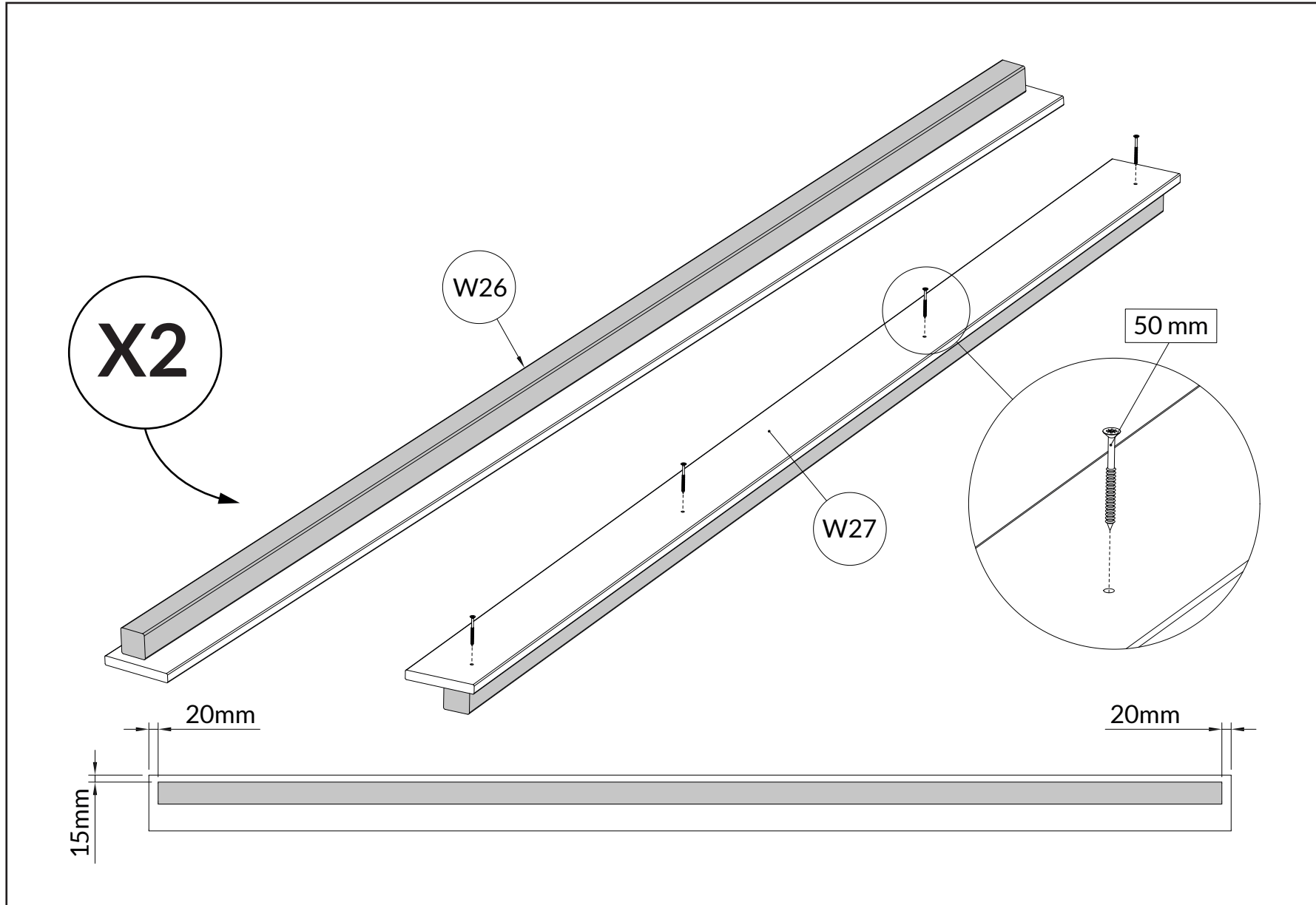

W26 x2

W27 x2

50mm x8

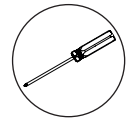
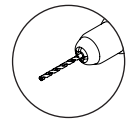

D7 x2

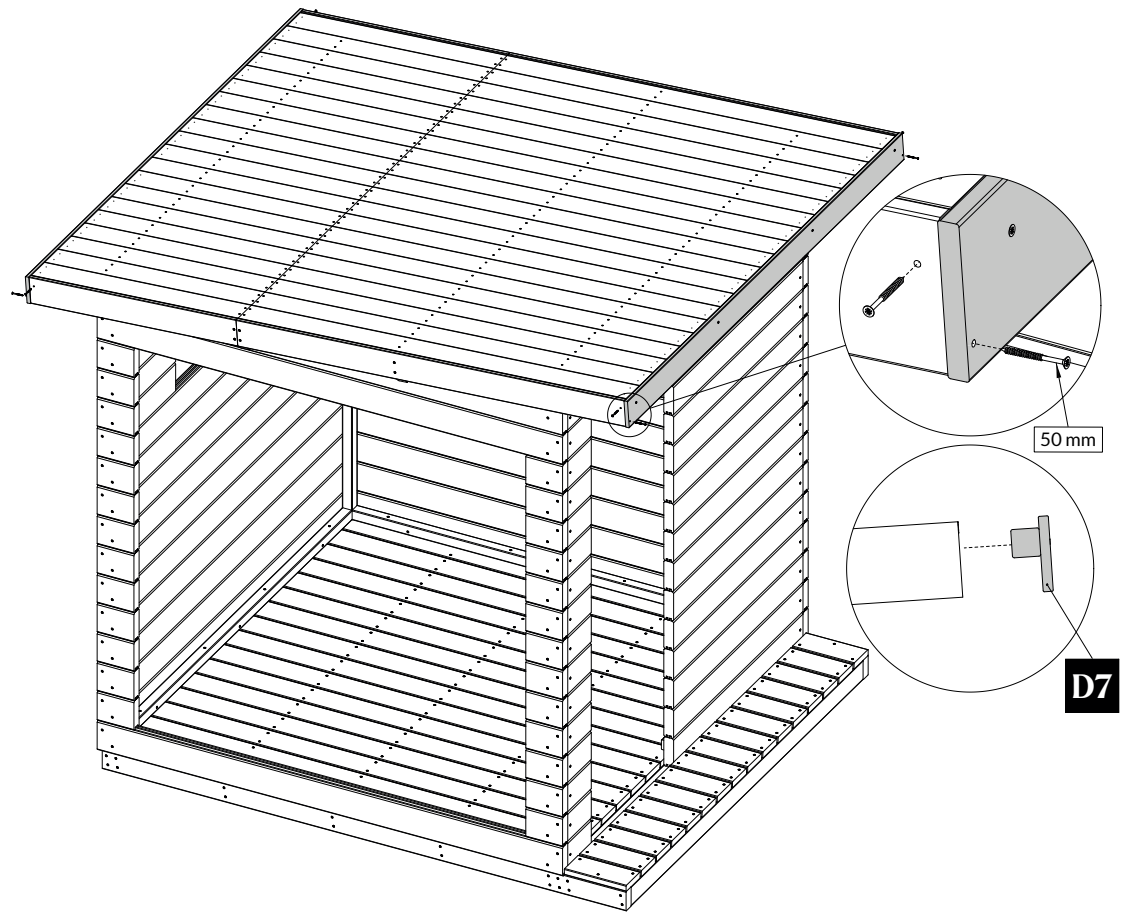

50mm x8

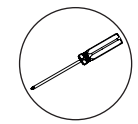
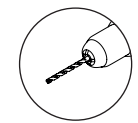

A|1→ B|1→ C|1→2→3→4→ D|1→2→3→4→5→6→7→8→9→
E|1→2→ F|1→2→3→ G|1→ H|1→2

D8

D9

A|1→ B|1→ C|1→2→3→4→ D|1→2→3→4→5→6→7→8→9→
E|1→2→ F|1→2→3→ G|1→ H|1→2

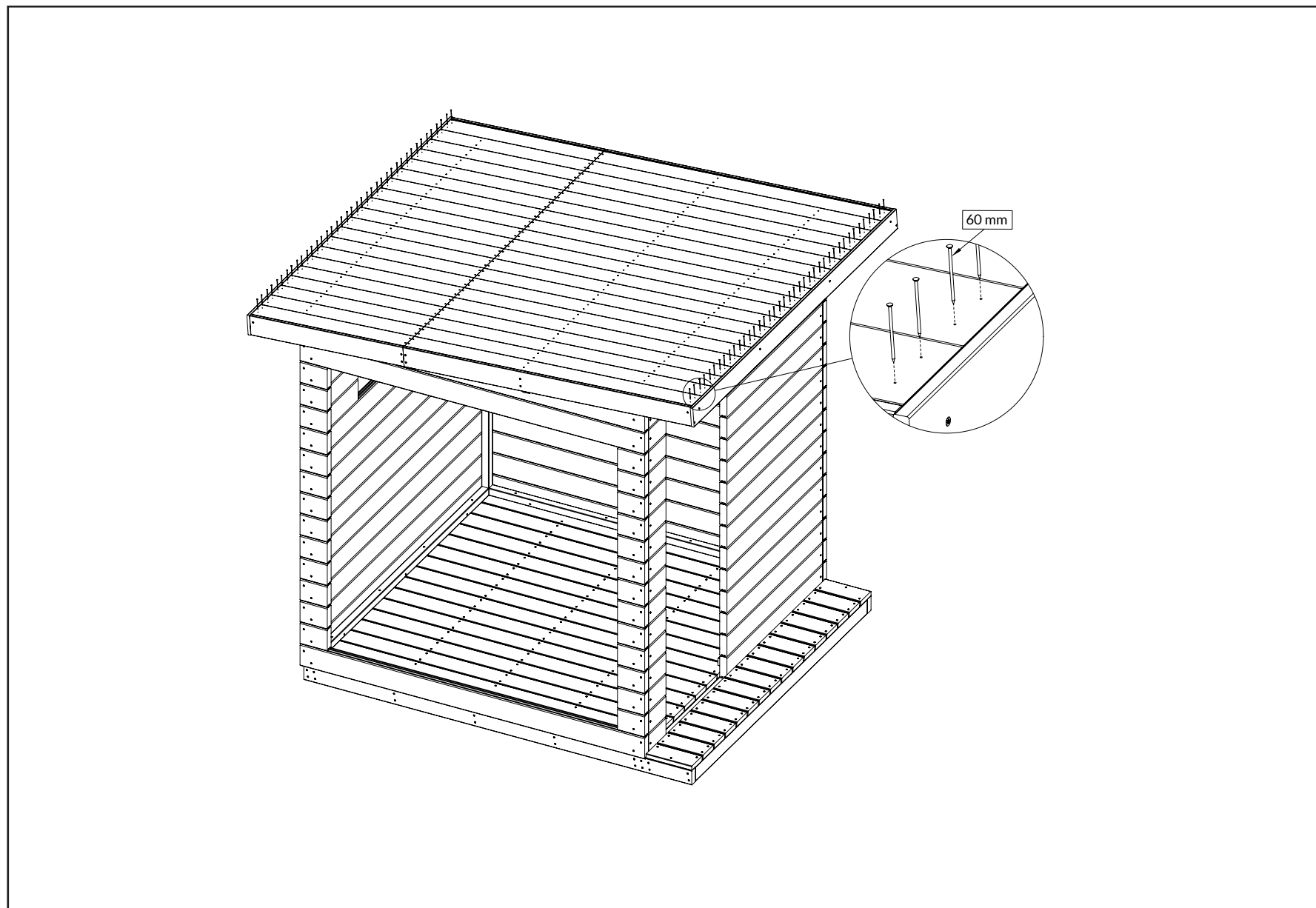

60mm



E

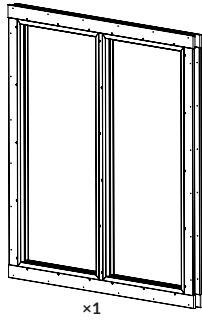
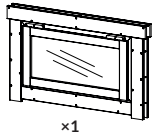

50mm

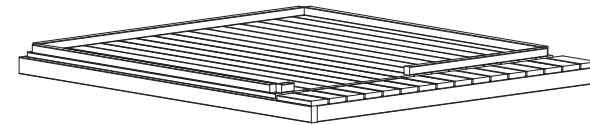
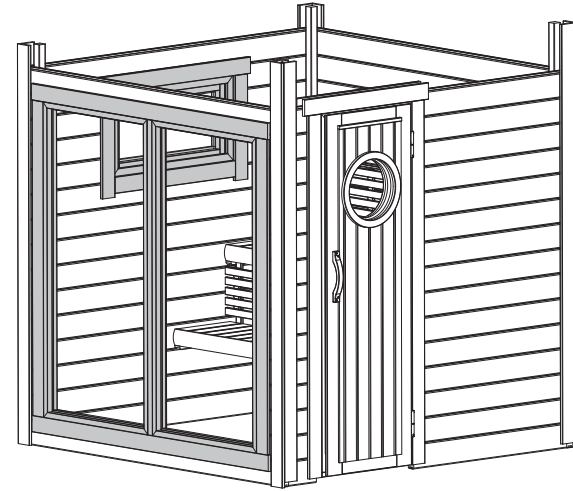
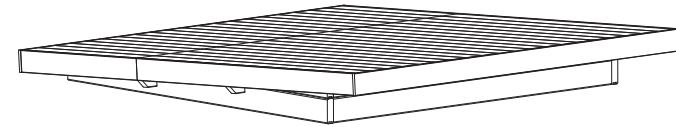

E

E1

A|1→ B|1→ C|1→2→3→4→ D|1→2→3→4→5→6→7→8→9→
E|1→2→ F|1→2→3→ G|1→ H|1→2

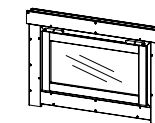
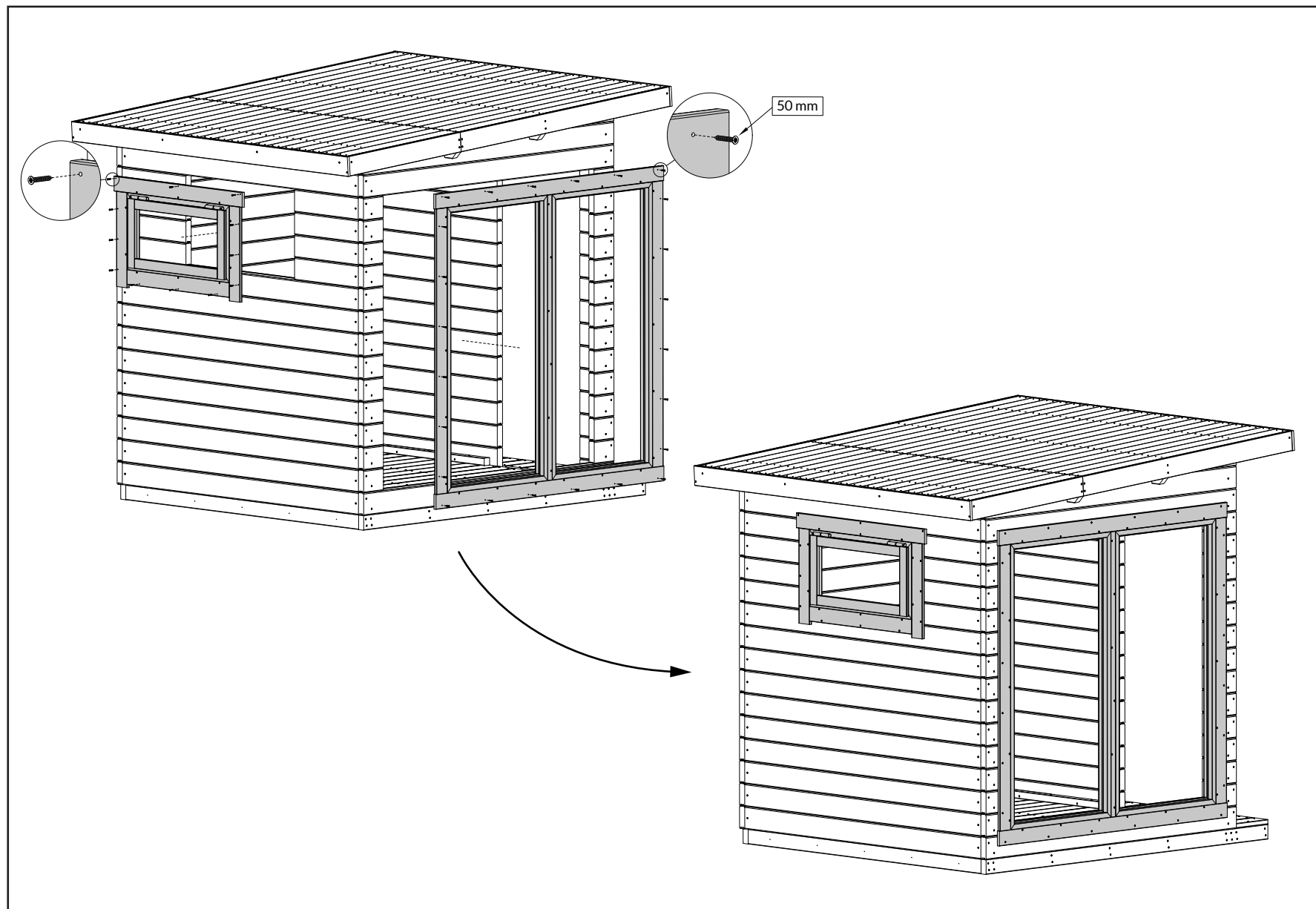

x1

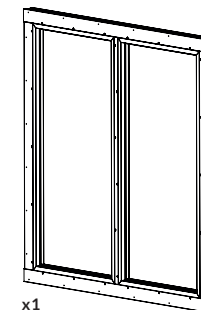

x1

50mm x36

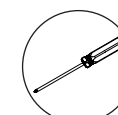
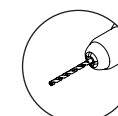
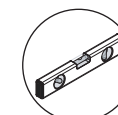

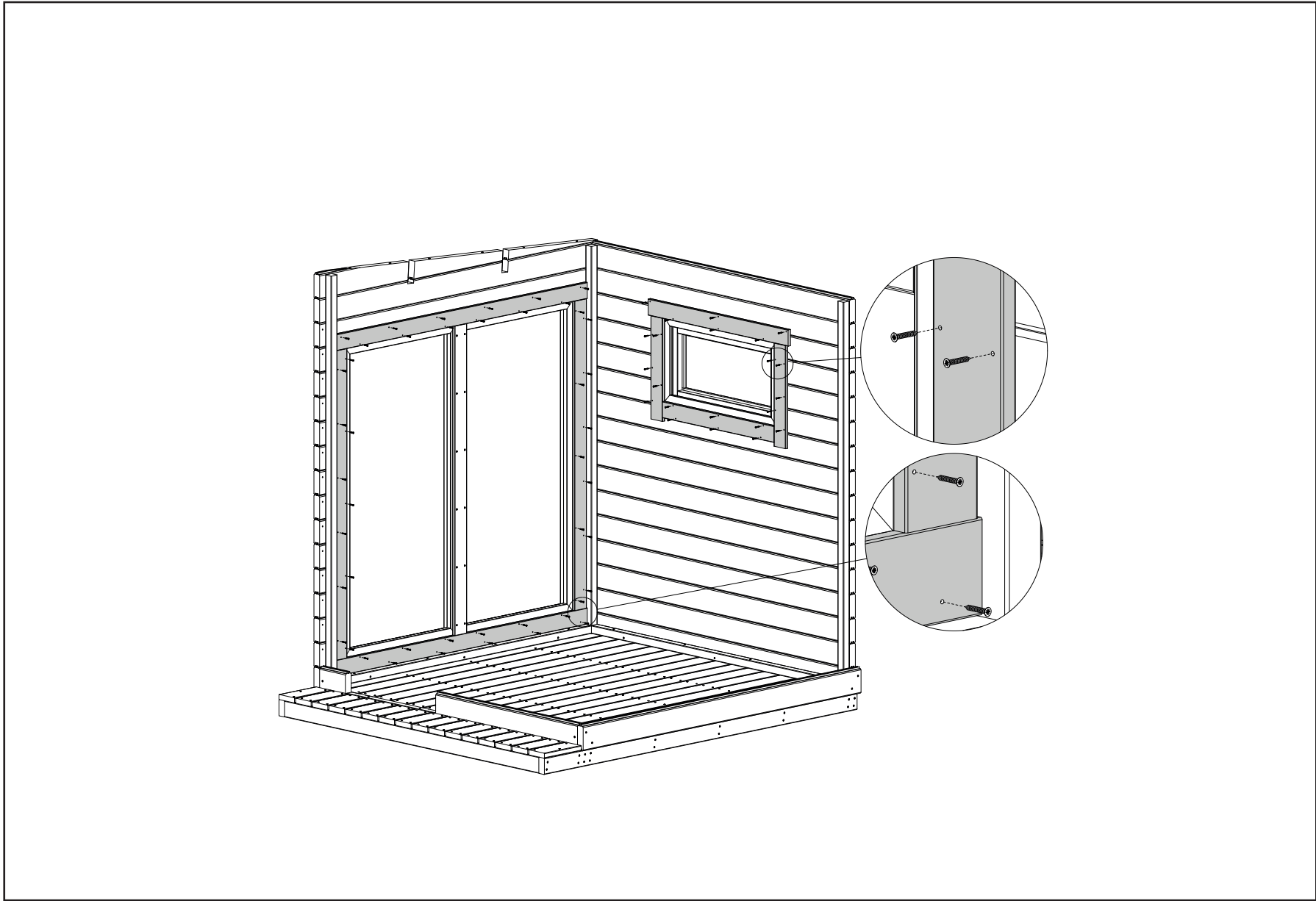

50mm x36

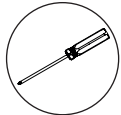
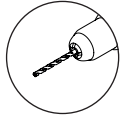
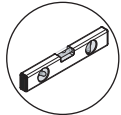



A|1→ B|1→ C|1→2→3→4→ D|1→2→3→4→5→6→7→8→9→
 E|1→2→ F|1→2→3→ G|1→ H|1→2

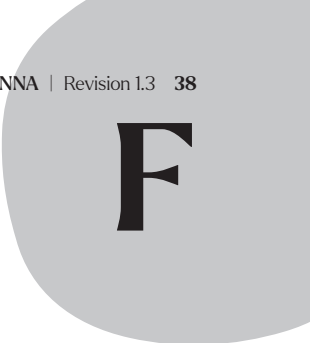

E2

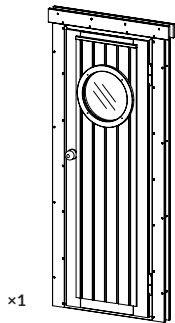

F



W28 □  
x1 (28x48) x 700mm (SWE-1)

-  50mm
-  60mm

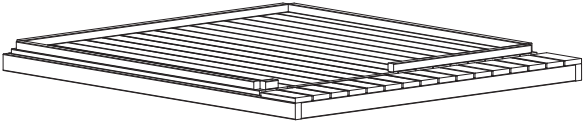
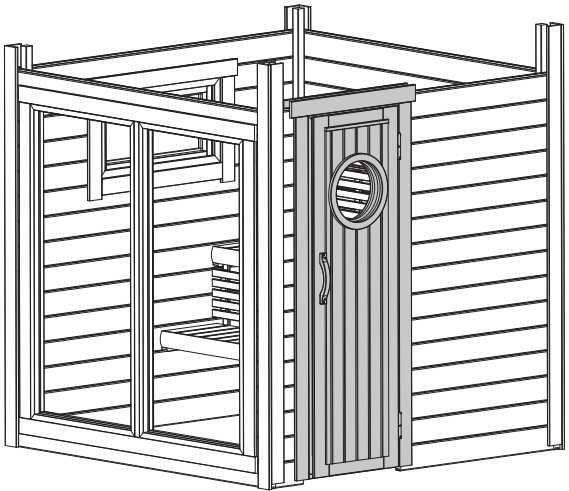

W28 x1

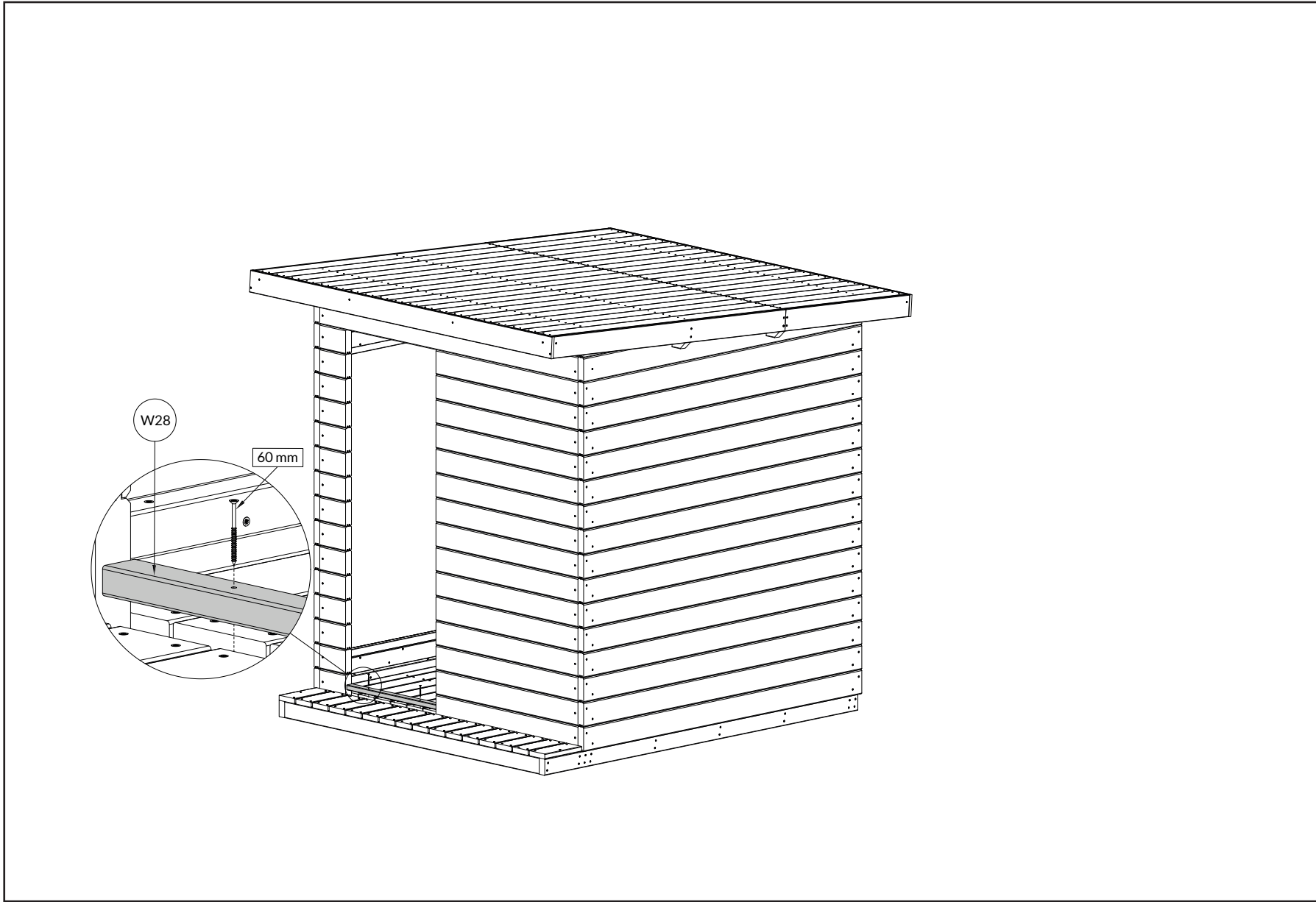

A|1→ B|1→ C|1→2→3→4→ D|1→2→3→4→5→6→7→8→9→
E|1→2→ F|1→2→3→ G|1→ H|1→2

F1

F2

A|1→ B|1→ C|1→2→3→4→ D|1→2→3→4→5→6→7→8→9→
E|1→2→ F|1→2→3→ G|1→ H|1→2

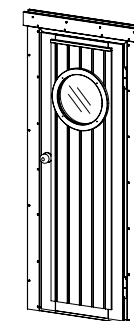
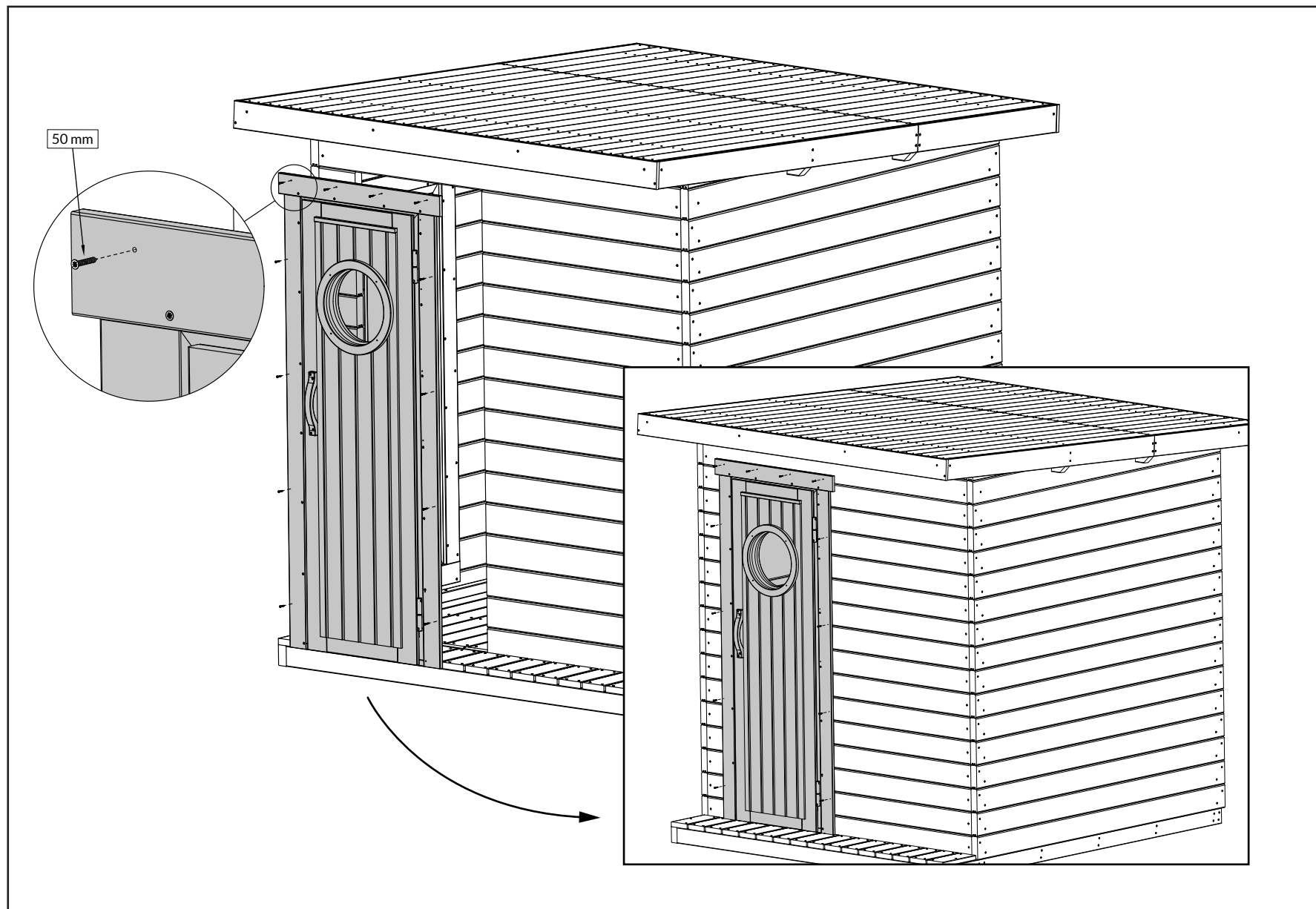

x1

50mm x12

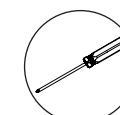
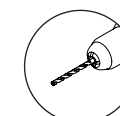
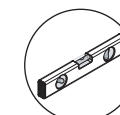

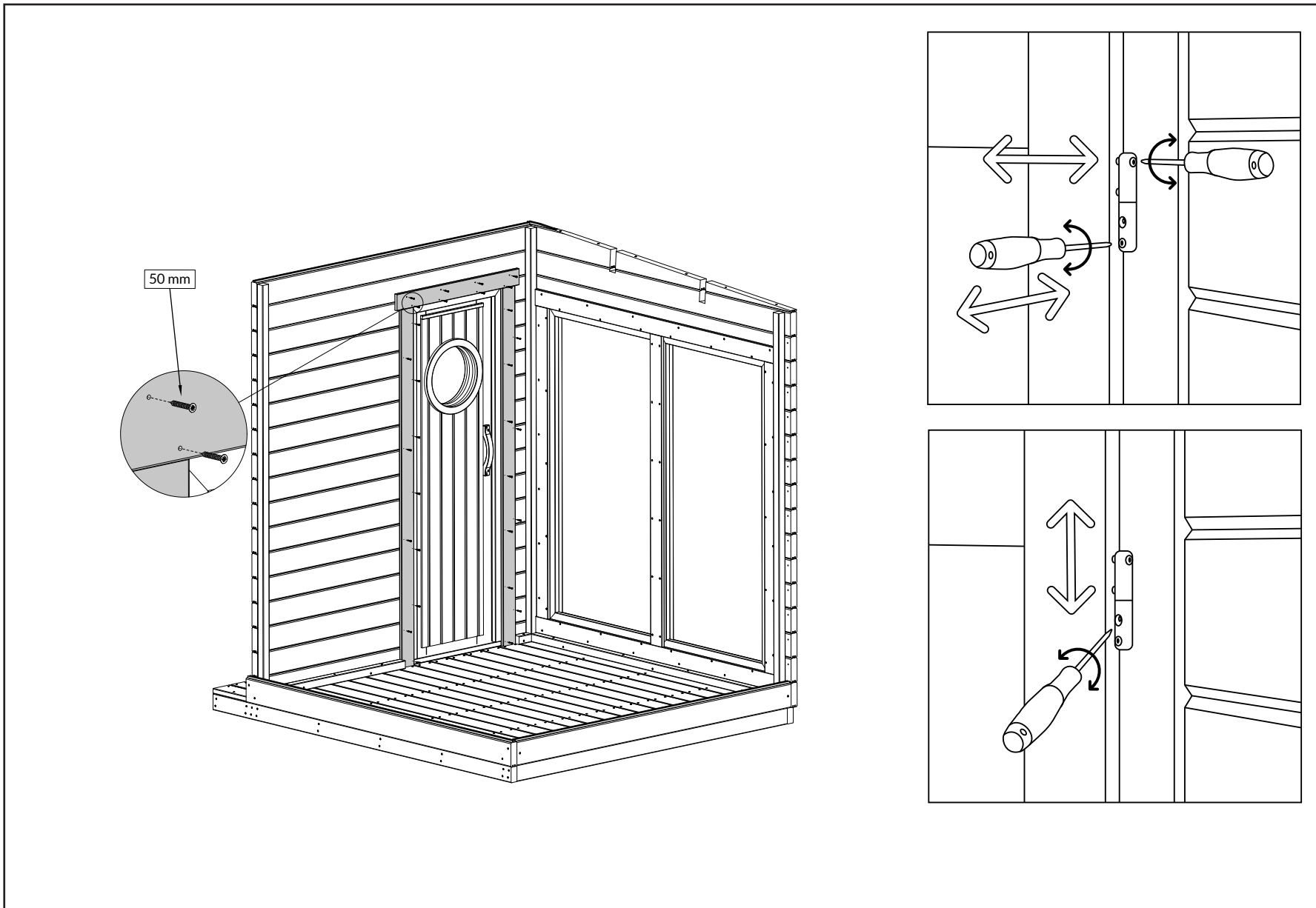

50mm x12

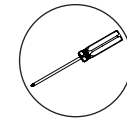
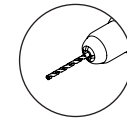
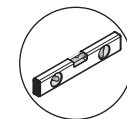



A|1→ B|1→ C|1→2→3→4→ D|1→2→3→4→5→6→7→8→9→
 E|1→2→ F|1→2→3→ G|1→ H|1→2

F3

G

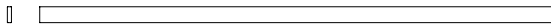
G

W29 
×2 (70×18) × 2265mm (TBE7-2)

W30 
×2 (90×18) × 2295mm (TBE8-2)

W31 
×2 (90×18) × 2160mm (TBE8-1)

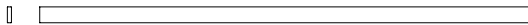
W32 
×2 (70×18) × 2160mm (TBE7-1)



50mm

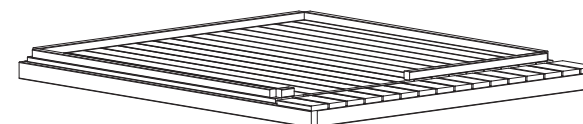
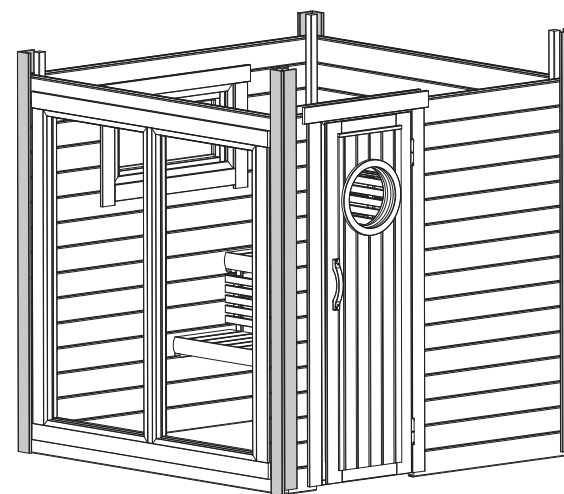

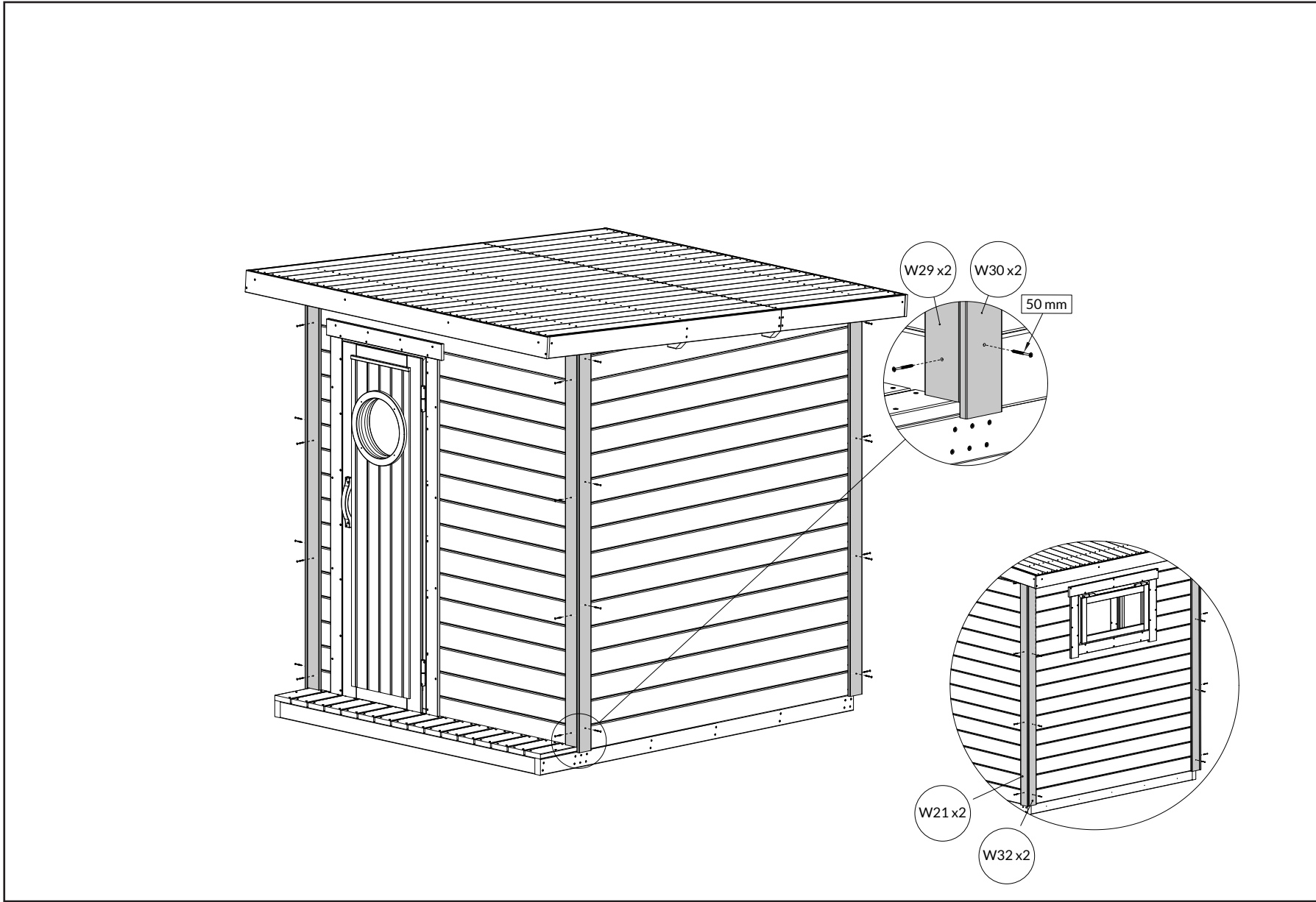

W29 x2

W30 x2

W31 x2

W32 x2

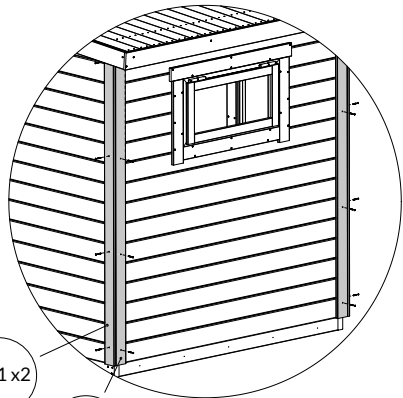
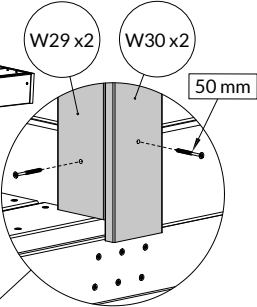

50mm x8

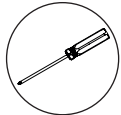
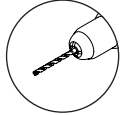

A|1→ B|1→ C|1→2→3→4→ D|1→2→3→4→5→6→7→8→9→
 E|1→2→ F|1→2→3→ G|1→ H|1→2

G1

H

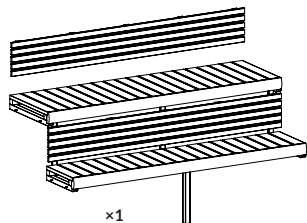

W33
x3 (43x43) x 1914mm (PF-1)



80mm

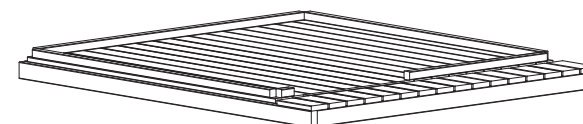
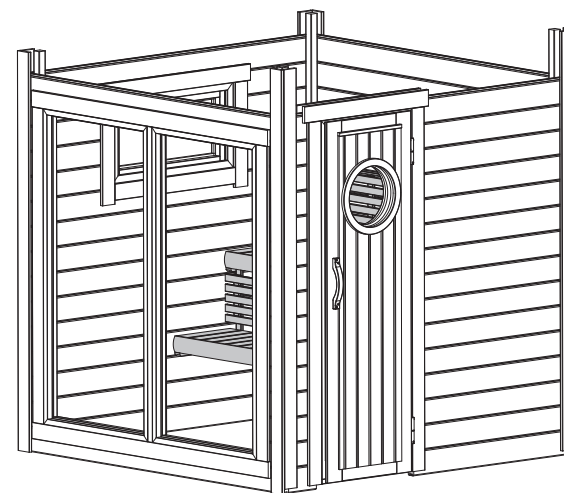

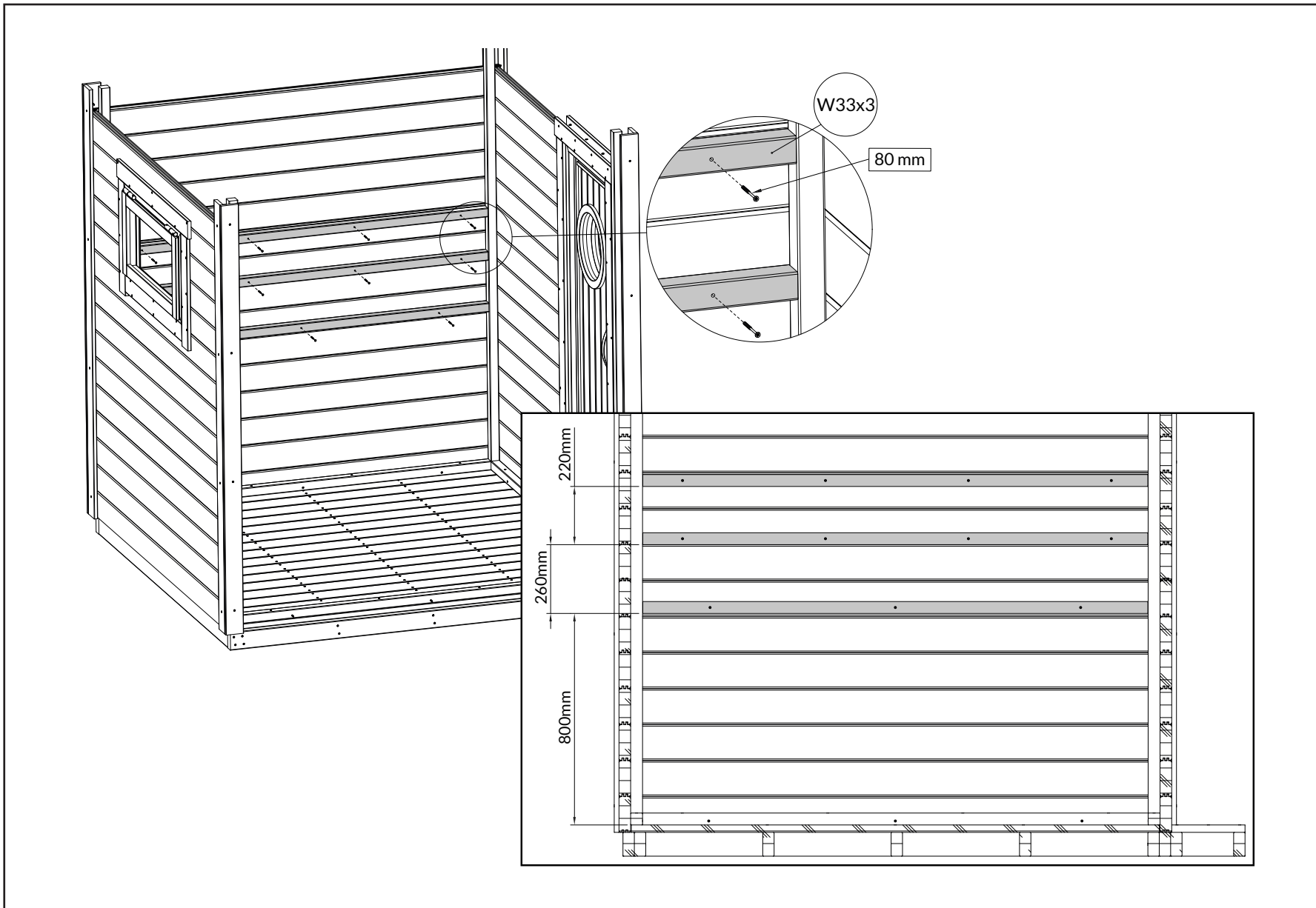

W33 x3

W33x3

80 mm

220mm
260mm
800mm

80mm x11

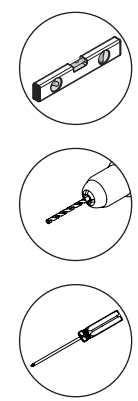

A|1→ B|1→ C|1→2→3→4→ D|1→2→3→4→5→6→7→8→9→
E|1→2→ F|1→2→3→ G|1→ H|1→2

H1

A|1→ B|1→ C|1→2→3→4→ D|1→2→3→4→5→6→7→8→9→
E|1→2→ F|1→2→3→ G|1→ H|1→2

H2

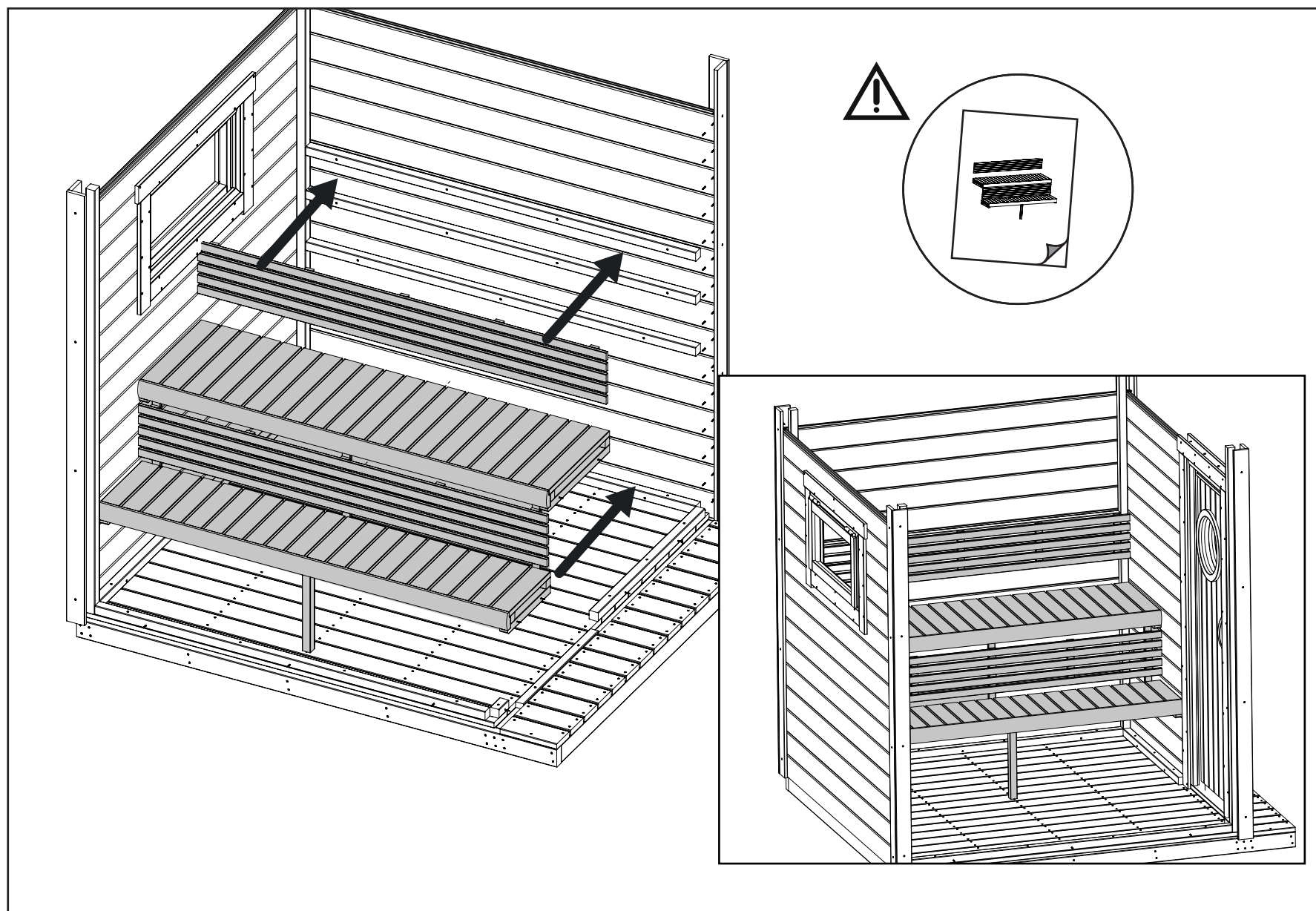
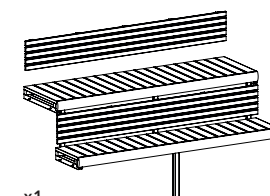

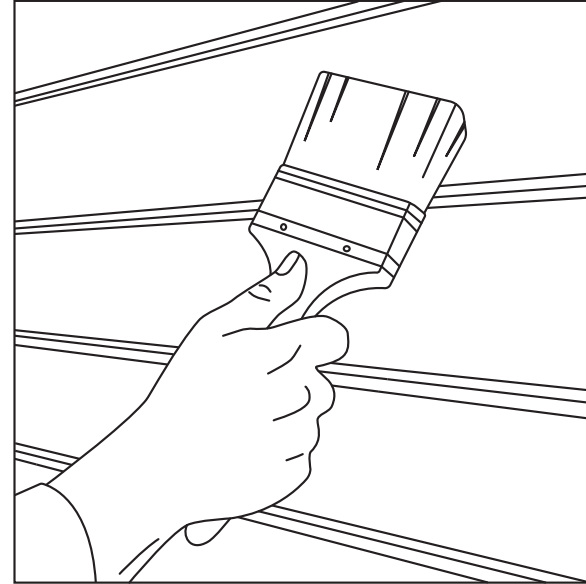
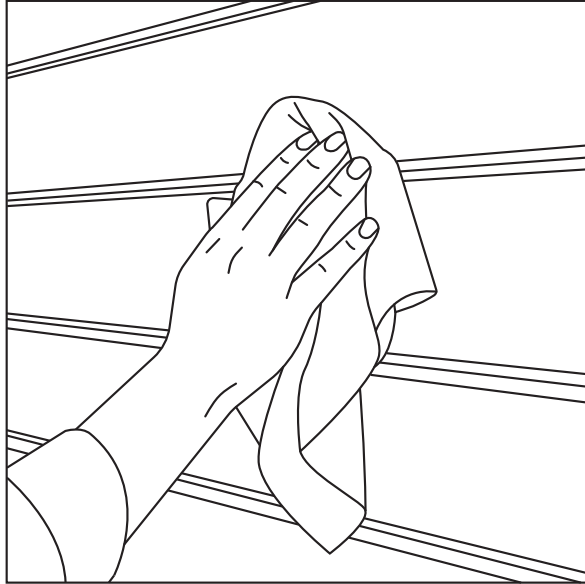

polhus.com

A series of horizontal dotted lines spanning the width of the page, providing a guide for handwriting practice.



Polhus was founded in Mora, a small town in the heart of Sweden, known for its craftsmanship tradition. We build wooden houses and saunas to bring joy, laughter and shared moments into your home and everyday life.

Crafting MOMENTS