

## Operating manual – Lifting system SE with SCT iSMPS

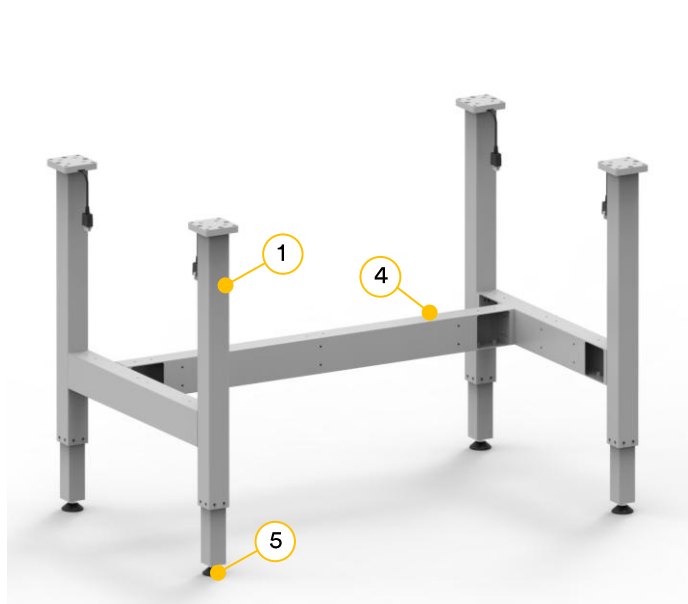

It is essential to read this operating manual thoroughly before commissioning the system. The manual must be kept in close proximity to the system for future reference.

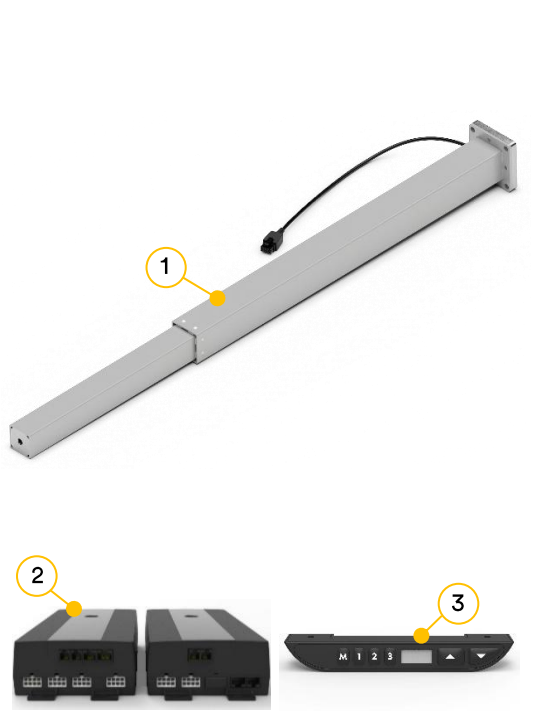

- ① Spindle lifting column of type SE
- ② Control box SCT iSMPS
- ③ Hand switch Memory

- Example of a frame with two lifting columns:
- ④ Crossbar
  - ⑤ Adjustable foot

Errors and technical changes reserved.

Ergoswiss AG does not assume any liability for operating errors or using the products outside of the intended purpose use.

At the time of delivery Ergoswiss AG will replace or repair defect products within accordance with the warranty provisions. In addition, Ergoswiss assumes no other liability.

For your questions and special custom demand Ergoswiss AG will be at your disposal.

**Ergoswiss AG**  
Nöllenstrasse 15a  
CH-9443 Widnau  
Tel.: +41 (0) 71 727 06 70  
Fax: +41 (0) 71 727 06 79

info@ergoswiss.com  
www.ergoswiss.com

## This operating manual applies to:

### Lifting system SE x3xx with Control box SCT iSMPS

Example.: Lifting system SE.3 4330 EU 12 (Article no.: 908.42036)

	Description	Standard variations
SE.3	Lifting element type	SE.3
4330	Number of lifting elements	1, 2, 3, 4
4330	Spindle pitch in mm	3 mm
4330	Stroke length in cm	30 cm
EU	Power cable	EU, CH, US
12	11 = Hand switch Up-Down ; 12 = Memory	12

### Frame SE x3xx with Control box SCT iSMPS

Example.: Frame SE.3 4330 1000 EU 12 (Article no.: 908.52073)

	Description	Standard variations
SE.3	Lifting element type	SE.3
4330	Number of lifting elements	4
4330	Spindle pitch in mm	3 mm
4330	Stroke length in cm	30 cm
1000	Distance between lifting elements	Crossbar
EU	Power cable	EU, CH, US
12	11 = Hand switch Up-Down ; 12 = Memory	12

### Other versions

	Description
s01-s99	Special version: adapter plate, table foot, fitting length, color, etc.

## Notes over the operating manual:

Lifting systems from Ergoswiss AG are intended for installation in an overall system (e.g. assembly table) and classified under the category of incomplete machines in accordance with the Machinery Regulation (EU) 2023/1230.

This operating manual contain information on the commissioning, handling and safety of the lifting system and are aimed at the further- user and manufacturer of the entire system. The further-user of this lifting system is obliged to create an operating manual with all usage information and hazard warnings for the entire system.

The declaration of incorporation is only valid for the Ergoswiss lifting system and not for the overall system created by the further-user.

## Table of content

<b>1</b>	<b>Safety requirements</b>	<b>4</b>
1.1	Explanations of the symbols and notes	4
<b>2</b>	<b>System description</b>	<b>5</b>
2.1	General information	5
2.2	Intended purpose use	5
2.2.1	General safety instructions	5
2.3	Target group and prior knowledge	6
2.4	Performance characteristics	7
2.4.1	Lifting column SE 13xx	7
2.4.2	Control box SCT2 iSMPS and SCT4 iSMPS	7
2.4.3	Hand switch Up/Down and Memory	7
2.4.4	System data	8
<b>3</b>	<b>Preparation for initial operation</b>	<b>9</b>
<b>4</b>	<b>Initial operation</b>	<b>10</b>
4.1	Plug detection	10
4.2	Duty cycle monitoring	10
<b>5</b>	<b>Operation with Hand switch Type Memory</b>	<b>11</b>
5.1	Operation with Hand switch Memory C	12
5.1.1	Drive Up / Down	12
5.1.2	Saving and approaching a memory position	12
5.1.3	Restore memory positions to factory settings «M-Pre»	13
5.1.4	Limit the stroke length (Container-Stop/Shelf-Stop)	14
5.1.5	Setting the shown height on the display «Height»	15
5.1.6	Changing the displayed unit of measurement (cm/inch) «Unit»	15
5.1.7	Deactivating / activating the tilt sensor «Sens»	16
5.1.8	Deactivating / activating the link detection «Link»	17
5.1.9	Change controller status primary/secondary «Pri-Sec»	17
5.1.10	Deactivating / activating max. speed under high load «Speed»	18
5.1.11	Query firmware (controller / hand switch)	18
5.1.12	Locking the movement (child protection)	19
5.1.13	Reference drive – Referencing the end positions	20
5.1.14	Basic initialization «Init»	21
5.2	Operation with Hand switch Memory T6	22
5.2.1	Drive Up / Down	22
5.2.2	Saving and approaching a memory position	22
5.2.3	Limit the stroke length (Container-Stop/Shelf-Stop)	23
5.2.4	Setting the shown height on the display «S 06»	24
5.2.5	Changing the displayed unit of measurement (cm/inch) «S 07»	24
5.2.6	Deactivating / activating the tilt sensor «S 08»	25
5.2.7	Restore memory positions to factory settings «S 13»	26
5.2.8	Locking the movement (child protection)	26
5.2.9	Reference drive – Referencing the end positions	27
5.2.10	Basic initialization «S 00»	28
<b>6</b>	<b>Synchronize 2 control boxes</b>	<b>29</b>
6.1	Cable connections	29
6.2	Initial operation of the synchronized systems	29
<b>7</b>	<b>Safety strip – Squeezing protection</b>	<b>30</b>
7.1	Commissioning	30
<b>8</b>	<b>Error codes and trouble shooting</b>	<b>31</b>
8.1	Error codes on the display	31
<b>9</b>	<b>Maintenance, cleaning and disposal</b>	<b>33</b>
<b>10</b>	<b>Declaration of Incorporation</b>	<b>34</b>

## 1 Safety requirements

The safety instructions must be paid attention to! If the system is operated improperly or not in accordance with the intended use, there may be a risk to persons and property!

Before installing and operating the lifting system, this operating manual must be read and understood. The manual must be kept in the close proximity to the system for future reference.

### 1.1 Explanations of the symbols and notes

The following explanations of symbols and notes must be observed. These are classified according to ISO 3864-2 (ANSI Z535.4).

#### DANGER



Indicates an imminent danger.  
Failure to follow the information will result in death or severe physical injury (disability).

#### WARNING



Indicates a potentially dangerous situation.  
Failure to follow the information will result in death or severe physical injury (disability).

#### ATTENTION



Indicates a potentially dangerous situation.  
Failure to follow the information will result in damage to property and minor or medium physical injuries will result.



**NOTE**  
Indicates general information, useful user tips and work recommendations, which have no impact on the health and safety of staff.

## 2 System description

### 2.1 General information

The basic functionality of a spindle lifting system SE by Ergoswiss AG is the lifting and lowering of work surfaces, machine parts, profile systems, etc.

An operative spindle lifting System SE consists of a minimum of following components:

- Lifting column SE
- Control box SCT iSMPS
- Hand switch
- Country specific power cable

The lifting column SE consists of two powder coated steel profiles which are guided with plastic guides. The inner profile is moved by an inline spindle drive. Up to 4 spindle lifting elements can be connected to one control box SCT4 iSMPS and be operated synchronously.

The high-performance control box SCTx iSMPS is equipped with two (SCT2) or four (SCT4) motor channels, which are adjusted synchronously by an encoder converter. Due to the optimised driving comfort, the end positions are gently approached as low-speed zones up to the standstill. An integrated tilt sensor reacts to the system tipping and can prevent potentially dangerous situations. Additional functions, such as the synchronisation of two control boxes or the connection of safety strips (squeezing protection) can be used.

With the hand switch Memory the lifting system can be operated comfortably, the work surface will be adjusted steplessly in its height.

The current height of the work surface is shown continuously on the display (in cm or inches). In addition, up to three different memory positions can be saved and approached individually. Errors that occur are also shown on the display.

### 2.2 Intended purpose use

System is designed for:	NOT scope of application:
<ul style="list-style-type: none"> <li>→ Height adjustment of worktops</li> <li>→ Height adjustment of machine parts</li> <li>→ Height adjustment of profile systems</li> <li>→ ... the list is not exhaustive</li> </ul>	<ul style="list-style-type: none"> <li>→ Clamping tool or press</li> <li>→ Security component</li> <li>→ Lifting platforms / personnel transport only in consultation with Ergoswiss AG</li> </ul>

#### 2.2.1 General safety instructions

<b>ATTENTION</b>	
	<p>The safety instructions must be paid attention to! If the system is operated improperly or not in accordance with the intended use, there may be a risk to persons and property!</p>

**The lifting system may be used if:**

- it is located in closed rooms, in a dry and non-explosive environment.
- the ambient temperature is between +10 °C and +40 °C.
- the relative humidity range is between 30% and 85% (non-condensing).
- there are no strong electromagnetic fields nearby.
- This device can be used by children aged 8 and over and by persons with reduced physical, sensory or mental abilities or lack of experience and knowledge if they are supervised or have been instructed in the safe use of the device and the resulting dangers to understand.

**The lifting system must not be:**

- operated outside of the performance data (max. tensile, compressive, bending moment loads).
- subjected to impulse, impact and impact forces (e.g. setting down loads).
- operated with an incorrect mains voltage! Adhere to the type plate of the control box!
- designed for continuous operation (below the duty cycle).
- operated on unstable or sloping ground.
- operated with impermissible or non-designated components.  
(e.g. different types of lifting elements; replacement of the control (control software))
- operated with damaged components.
- opened, reworked or rebuilt.
- operated if the power cable is not freely accessible. Disconnect the power cord in the event of a fault.
- Children must not play with the device. Cleaning and user maintenance shall not be made by children without supervision.

When installing and operating the lifting system, the intended use of the entire system must be adhered to. Commissioning is prohibited until the entire system complies with the provisions of the Machinery Regulation (EU) 2023/1230. For this purpose, it is essential to perform a risk analysis, so that possible residual hazards can be reacted to (e.g. through constructive measures or through instructions in the operating manual and/or through safety indication on the system). In the event of improper use, the liability of Ergoswiss AG and the general operating permit for the lifting system will expire.

## **2.3 Target group and prior knowledge**

---

Before installing and operating the lifting system, this operating manual must be read and understood. The manual must be kept in close proximity to the system for future reference.

This operating manual addresses the following groups of people:

The **manufacturer of the overall system** who integrates this lifting system into an overall system and integrates this operating manual into the operating manual for the overall system.

The **commissioning personnel** who install the lifting system in a workplace, a machine, etc. and put it into operation. For commissioning basic mechanical and electrical knowledge are required.

## 2.4 Performance characteristics

### 2.4.1 Lifting column SE 13xx

	Lifting column SE.3 13xx
Cross-section	50 x 50 mm (1.97" x 1.97")
Standard stroke length	300 (12")
Installation length	Stroke length + 340 mm (13.39") Lower block position = stroke length + 337 mm (13.27")
Weight	SE.3 1330 = 4.7 kg (10.4 lbs)
Max. allowed pressure load	1'500 N (337 lbf)
Max. allowed tensile load	1'500 N (337 lbf)
Max. allowed bending moment	Mb stat. 300 Nm (221 lbf·ft) ① Mb dyn. 120 Nm (89 lbf·ft) ①
Power consumption	5 A per lifting column (at maximum load)
Voltage	24 V
Lifting speed	9 mm/s (0.35 "/s)
Noise level	< 60 dBA
Protection class (DIN EN 60529)	IP 20
Electrical connection	Molex MiniFit plug 8 Pin; Cable length 1'800 m (71")
End switch	No (reading Encoder)
Tested product life	5'000 cycles with 300 mm (12") stroke length 1'500 N (337 lbf) pressure load, duty cycle 2/18 ②

① stat. = during standstill; dyn. = during stroke movement

② Duty Cycle 2/18; operating max. 2 min, pause 18 min

### 2.4.2 Control box SCT2 iSMPS and SCT4 iSMPS

Dimension (L x B x H)	309 x 120 x 55 mm (12.2" x 4.7" x 2.2")
Weight	SCT2: 1.12 kg (2.47 lbs) SCT4: 1.24 kg (2.73 lbs)
Supply voltage	EU: 207 – 254.4 V 50 Hz 4.5 A US: 103.5 – 127.2 V 60 Hz 7.4 A
Primary standby power	< 0.6 W
Power	580 VA ; 20 A @ 29 V DC
Protection class (DIN EN 60529)	IP 20
Performance Level (DIN EN 13849-1)	PL b
Firmware	1.10

### 2.4.3 Hand switch Up/Down and Memory

Electrical connection	RJ-12 plug 6 Pin; Cable length 2 m (79")
Protection class (DIN EN 60529)	IP 30
Firmware	0.34 (SCT Memory C); 0.49 (SCT Memory T6)

**2.4.4 System data**

# lifting elements	Max. system load [kg] (lbs)	Stroke length [mm] (in)	Lifting element Type	Control box SCT iSMPS		Lifting speed	② Duty cycle [On/Off]
				230 V	110 V		
1	150 (330)	300 (12")	① 1330	V1801	V3801	9 mm/s (0.35 ''s)	2/18 min
2	300 (660)	300 (12")	① 1330	V1801	V3801		
3	450 (990)	300 (12")	① 1330	V1801	V3801		
4	600 (1'320)	300 (12")	① 1330	V1801	V3801		
5	650 (1'430)	300 (12")	① 1330	2x V1801	2x V3801		
6	700 (1'540)	300 (12")	① 1330	2x V1801	2x V3801		
7	750 (1'650)	300 (12")	① 1330	2x V1801	2x V3801		
8	800 (1'760)	300 (12")	① 1330	2x V1801	2x V3801		

① Lifting column SE

② Duty cycle 2/18; operating max. 2 min, pause 18 min

**NOTE**

The lifting system can be subjected to uneven loads as long ...



- the max. load on the single lifting element is not exceeded,
- the max. bending torque of the lifting element is not exceeded,
- the entire system is located on sufficient safe ground

... and the entire plant has been constructed in accordance with the provisions of the mechanical equilibrium. → Conducting a risk analysis

**ATTENTION**



High pulse / impact forces due to the discontinuation of loads are not allowed.  
(e.g. discontinuation of loads in feed with crane or forklift)



### 3 Preparation for initial operation

#### ATTENTION



During mounting of the control box the power cable needs to be disconnected from the mains!

#### ATTENTION



Connecting homemade products to the control box is prohibited!  
Only use supplied components.



#### NOTE

The control box has an integrated tilting sensor as standard. To ensure the smooth normal operation, the control box must be fixed rigidly to the system before initial commissioning. (e.g. below the tabletop)



#### NOTE

In some cases, the lifting element must be equipped with an additional motor-to-control box adaptor cable.

1. Connect the motor cables to the control box in the correct order from **1** to **4**.  
(Automatic plug detection on all sockets)
2. Connect the hand switch to the control box.  
If necessary, optional components can now be connected (e.g. safety strips, sync cable).
3. Connect the power cable to the control box.



#### NOTE

Before connecting the power cable to the mains the following must be verified:  
→ Does the mains voltage correspond to the value on the name plate of the control box?  
→ Are the plugs of the motor cable connected to the correct sockets (**1** to **4**)?  
→ Is the entire lifting system assembled according to the assembly instructions?

4. Connect power cable to the mains.

## 4 Initial operation

### ATTENTION



Danger of squeezing during height adjustment!

### ATTENTION



It must be possible to fully retract the lifting element to its lower block position at any time (also in the operating state).  
If the lifting element cannot retract completely and hits a stop before it reached its lower block position, the zero position is set incorrectly. This leads to a collision when moving up to the upper block position.

### ATTENTION







The system may only be fully loaded after the initial operation has been completed.  
During the initial operation, the lifting system may be loaded with max. 50% of the system load.



#### NOTE

During the initial operation, the lifting system drives with half the speed.

1. Keep the buttons  and  pressed simultaneously to drive the lower block position.  
The system moves downwards at half speed. Upward movement is disabled.
2. After reaching the block position, the system will drive out a few millimeters.  
Afterwards the control box will emit 3 signal sounds.
3. let go of the buttons  and .

After reaching the block position, the lower and the upper position will be stored automatically.  
The initial operation is completed.



#### NOTE

The lower position is 3 mm (0.12") higher than the block position. The upper position depends on the lifting element type, resp. of the control box software.

### 4.1 Plug detection

The control box can detect whether a lifting element is plugged into the relevant socket.

The control box only recognizes during the lifting movement whether a lifting element has been removed.  
After plugging out or replacing a lifting element the system must be reset to synchronize all connected lifting elements.

### 4.2 Duty cycle monitoring

The duty cycle monitoring checks the ratio between the operation time and standstill time. To avoid overheating of the system a duty cycle of 2/40 (ON/OFF) should be maintained.

The maximum continuous operating time is 2 minutes. Afterwards a pause of at least 40 minutes needs to be observed before the system can be operated again.

## 5 Operation with Hand switch Type Memory

Hand switch SCT Memory C – Article no.124.00293



Hand switch SCT Memory T6 – Article no. 124.00281



### NOTE

When using a Hand switch of the Type Up / Down (Article no. 124.00292 or 124.00280) only the following sections are relevant..

- 5.1.1 Drive Up / Down
- 5.1.13 Reference drive

## 5.1 Operation with Hand switch Memory C

### 5.1.1 Drive Up / Down

This function is used for easy height adjustment of the system.

Press the button  or .





Keep the button pressed until the desired working height is reached.

### 5.1.2 Saving and approaching a memory position

This function allows you to save a specific position/height and recall it at a later time with the press of a button. Using the 3 memory buttons and 4 memory levels, up to 12 different positions can be saved and recalled.

1. Press and hold the **M** button for 3 seconds.
2. You will then enter the individual memory levels (P0–P3).
  - Up to 3 positions can be stored per level.
  - The levels are color-coded on the side (left):
    - P0: no color
    - P1: yellow
    - P2: orange
    - P3: purple

The color coding allows you to easily identify the active memory level at any time.

3. Use the  or  buttons to select the desired level, then press the **M** button.
4. Move to the desired position and press the **M** button three times briefly.
5. Within 5 seconds, press one of the memory buttons   . After the saving process, the control unit emits one signal tone.

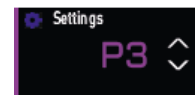
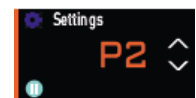
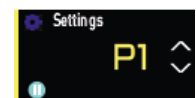











The position is now stored under the selected button and can be overwritten at any time using the same procedure.

#### Approaching a memory position:

Press and hold the selected memory button    until the desired working height is reached.

### 5.1.3 Restore memory positions to factory settings «M-Pre»

With this function it is possible to set all changed memory positions back to factory settings.

1. Press and hold   and  buttons simultaneously for 4 seconds.  
→ The display shows «Use».
2. Use the  or  buttons to select «M-Pre».
3. Confirm the selection «M-Pre» by pressing the **M** button.
4. Use the  or  button to select «Yes» or «No».
5. Confirm with the **M** button.
6. Press the   or  buttons to exit the mode.

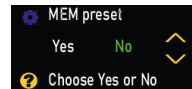

### 5.1.4 Limit the stroke length (Container-Stop/Shelf-Stop)

These two features can be used to limit the stroke length of the lifting system (e.g. if a container is under the table).



**NOTE**

The Shelf-Stop position limits the upper end position.  
The Container-Stop position limits the lower end position.



**NOTE**

To delete a set Shelf-stop position, a new one has to be done with the same procedure.  
To delete a set Container-stop position, a new one has to be done with the same procedure.

#### 5.1.4.1 Limit upper end position - Shelf-Stop «Upper»

To define a shelf stop position, proceed as follows:

1. Keep the buttons and pressed simultaneously for 4 seconds.  
→ The display shows «Use».
2. Use the or buttons to select «Upper».
3. Confirm the selection «Upper» with the button **M**.
4. Press the button or to drive to the desired Shelf-Stop position.
5. Confirm with the button **M**.
6. Press the button or to leave the menu mode.



#### 5.1.4.2 Limit lower end position – Container-Stop «Lower»











To define a container stop position, proceed as follows:

1. Keep the buttons and pressed simultaneously for 4 seconds.  
→ The display shows «Use».
2. Use the or buttons to select «Lower».
3. Confirm the selection «Lower» with the button **M**.
4. Press the button or to drive to the desired Container-Stop position.
5. Confirm with the button **M**.
6. Press the button or to leave the menu mode.



### 5.1.5 Setting the shown height on the display «Height»











The displayed height can be adjusted with this feature.

1. Keep the buttons   and  pressed simultaneously for 4 seconds.  
→ The display shows «Use».
2. Press the button  or  until «Height» is selected.
3. Confirm the selection «Height» with the button **M**.  
→ The display shows the current height.
4. Measure the height of the table.
5. Press the button  or  to adjust the measured height.
6. Confirm with the button **M**.
7. Press the button   or  to leave the menu mode.



### 5.1.6 Changing the displayed unit of measurement (cm/inch) «Unit»

This function can be used to change the height unit on the display from «cm» to «inch» or from «inch» to «cm».

1. Keep the buttons   and  pressed simultaneously for 4 seconds.  
→ The display shows «Use».
2. Press the button  or  until «Unit» is selected.
3. Confirm the selection «Unit» with the button **M**.  
→ The display blinks «cm» or «inch».
4. Press the button  or  to select the desired measurement unit.
5. Confirm with the button **M**.
6. Press the button   or  to leave the menu mode.

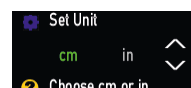

The unit of measurement on the display has now been changed from centimeters (cm) to inches (inch) or from inches to centimeters (2.54 cm = 1 inch).

### 5.1.7 Deactivating / activating the tilt sensor «Sens»

The control box has an integrated tilt sensor, which is activated by default.

The 0° inclination of the control is initialized during initial operation or reset. If the inclination of the control exceeds 2.5° (e.g. inclined table), the control box stops the lifting movement.

After triggering the tilt sensor, the system moves back by 10 mm (0.4"). If the inclination cannot be corrected (e.g. by driving in the opposite direction), a «Reference drive» must be performed.

## ATTENTION



The tilt sensor is not a safety element!  
There is still a risk of injury before the tilt sensor triggers.











### NOTE

In addition to a collision, the tilt sensor can be triggered by various causes. Therefore, the following should be observed:



- Install the control box rigidly before initial operation or reset.  
→ So that the inclination of 0° is properly initialized.
- After the system is moved, the tilt sensor should be reinitialized  
→ Perform a «Reference drive» (see chapter 5.1.13).
- For mobile applications (e.g. table on castors), the tilt sensor should be deactivated.

This function can be used to deactivate the active tilt sensor or to reactivate the deactivated tilt sensor.



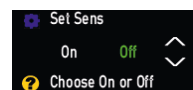







1. Keep the buttons   and  pressed simultaneously for 4 seconds.  
→ The display shows «Use».
2. Press the button  or  until «Sens» is selected.
3. Confirm the selection «Sens» with the button **M**.
4. Use the  or  buttons to select «on» or «off».
5. Confirm with the button **M**.
6. Press the button   or  to leave the menu mode.
7. If the tilt sensor is activated, the message «E dd» appears.  
For the new initialization of the tilt sensor, a «Reference drive» must now be performed.





### 5.1.8 Deactivating / activating the link detection «Link»





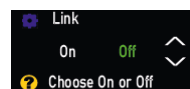





Up to two controllers can be linked together (depending on the system combination). If automatic link detection is enabled or disabled in the motor configuration, the link function can be activated or deactivated accordingly via this setting.

1. Keep the buttons   and  pressed simultaneously for 4 seconds.  
→ The display shows «Use».
2. Press the button  or  until «Link» is selected.
3. Confirm the selection «Link» with the button **M**.
4. Use the  or  buttons to select «On» (activating) or «Off» (deactivating).
5. Confirm with the button **M**.
6. Press the button   or  to leave the menu mode.



### 5.1.9 Change controller status primary/secondary «Pri-Sec»

This service allows switching the controller status between *Primary* and *Secondary*. The user can define which controller functions as the main controller (*Primary*) and which as the secondary controller (*Secondary*). Operation of the unit is then possible only via the Primary controller.

1. Keep the buttons   and  pressed simultaneously for 4 seconds.  
→ The display shows «Use».
2. Press the button  or  until «Pri-Sec» is selected.
3. Confirm the selection «Pri-Sec» with the button **M**.
4. Use the  or  buttons to select «Pri» (primary) or «Sec» (secondary).
5. Confirm with the button **M**.
6. Press the button   or  to leave the menu mode.

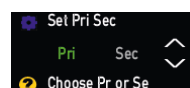

### 5.1.10 Deactivating / activating max. speed under high load «Speed»

This service allows the maximum speed limit under high load to be enabled or disabled. If the upper limit of the control range is reached, the system reduces the speed according to the configuration settings when the function is disabled. When the function is enabled, the controller attempts to maintain the maximum possible speed. Under certain extreme conditions, however, this may not be possible. In such cases, error E7A is displayed. Use of this service is only permitted after consultation with customer support and in special cases.

1. Keep the buttons **1** **2** and **▲** pressed simultaneously for 4 seconds.  
→ The display shows «Use».
2. Press the button **▲** or **▼** until «Speed» is selected.
3. Confirm the selection «Speed» with the button **M**.
4. Use the **▲** or **▼** buttons to select «Yes» (activating) or «No» (deactivating).
5. Confirm with the button **M**.
6. Press the button **1** **2** or **3** to leave the menu mode.

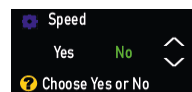

### 5.1.11 Query firmware (controller / hand switch)





This service allows the firmware version of both the controller and the hand switch to be easily read via the hand switch. This function provides the user with information, for example, when customer support requests the current firmware version to check the system status and provide targeted assistance.

1. Keep the buttons **1** **2** and **▲** pressed simultaneously for 4 seconds.  
→ The display shows «Use».
2. Use the **▲** or **▼** buttons to select «Ctr Unit Rev» to query the firmware version of the controller, or «Handset Rev» to display the firmware version of the hand switch.
3. Press the button **1** **2** or **3** to leave the menu mode.



### 5.1.12 Locking the movement (child protection)

The locking function can be used to lock the control panel of the hand switch to prevent unintentional operation of the lifting system.

By activating the locking function, the lifting system can no longer move. Neither a movement with the buttons  or  nor moving to a memory position    is possible.

The lifting system is in the locked state as long as it is not deactivated.

## ATTENTION



The locking function is not a safety element and does not avert danger!

#### Activate:

- Keep the buttons   and  pressed simultaneously for 4 seconds.  
→ The control gives an acoustic signal to confirm the activation.

The lifting system is now locked and the display shows «E 65».

If any of the buttons on the hand switch is pressed, a signal tone sound and the system will not move.

#### Deactivate:

- Keep the buttons   and  pressed simultaneously for 4 seconds.  
→ The control gives an acoustic signal to confirm the deactivation.

The system is not locked anymore and can be operated normally.

### 5.1.13 Reference drive – Referencing the end positions

#### ATTENTION



Before the reset, it must be ensured that:





- the lifting element can retract completely.
- the lifting system is loaded with a maximum of 50% of the maximum allowed system load.

If the lifting element cannot retract completely and hits a stop before it reached its lower block position, the zero position is set incorrectly. This leads to a collision when moving up to the upper block position.



#### NOTE

During restoring to the factory settings, the lifting system drives with half the speed.

1. If possible: Drive to lowest position with the button .  
→ This saves time because the system only drives with half speed when doing a reset.
2. Keep the buttons  and  pressed simultaneously to drive the lower block position.  
The system moves downwards at half speed. Upward movement is disabled.
3. After reaching the block position, the system will drive out a few millimeters.  
Afterwards the control box will emit 3 signal sounds.
4. Let go of the buttons  and .

After reaching the block position, the lower and the upper position will be stored automatically.  
The Reference drive is completed.

### 5.1.14 Basic initialization «Init»

#### ATTENTION



Before restoring to factory settings, it must be ensured that:

- the lifting element can retract completely.
- the lifting system is loaded with a maximum of 50% of the maximum allowed system load.

If the lifting element cannot retract completely and hits a stop before it reached its lower block position, the zero position is set incorrectly. This leads to a collision when moving up to the upper block position.



#### NOTE

During restoring to the factory settings, the lifting system drives with half the speed.

When restoring the factory settings, the entire system is newly set up again. All settings such as Memory positions or End positions are lost.

1. If possible: Drive to lowest position with the button .
  - This saves time because the system only drives with half speed when doing a reset.
2. If needed, the system can now be rewired
  - a. Remove the cable from the mains.
  - b. Rewire the system: More lifting elements, synchronization cables or safety strips can now be connected.
  - c. Connect the power cable to the mains.
3. Keep the buttons and pressed simultaneously for 4 seconds.
  - The display shows «Use».
4. Press the button or until «Init» is selected.
5. Confirm the selection «Init» with the button **M**.
  - The control gives an acoustic signal to confirm.
6. Use the or buttons to select «Yes» or «No» and confirm with the **M** button.
7. Press the button or to leave the menu mode.
  - The display shows «E dC».
8. Do an initial operation according to chapter 4.

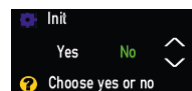

---

## 5.2 Operation with Hand switch Memory T6

---

### 5.2.1 Drive Up / Down

---

This function is used for easy height adjustment of the system.



Press the button  or .

Keep the button pressed until the desired working height is reached.

### 5.2.2 Saving and approaching a memory position



---

With this function it is possible to memorise a certain position/height and approach it at a later time by pushing one button. With the 3 memory buttons up to 3 different positions can be stored and approached.

1. Drive to the desired position and press the button **M** 3 times.
2. Press one of the buttons    within 5 seconds.  
After saving the control box will emit 1 signal sound.

The memory position is now stored under the pressed button.

**To approach a stored memory position:**

Keep one of the buttons    pressed until the desired working height is reached.

### 5.2.3 Limit the stroke length (Container-Stop/Shelf-Stop)

These two features can be used to limit the stroke length of the lifting system (e.g. if a container is under the table).



**NOTE**

The Shelf-Stop position limits the upper end position.  
The Container-Stop position limits the lower end position.



**NOTE**

To delete a set Shelf-stop position, a new one has to be done with the same procedure.  
To delete a set Container-stop position, a new one has to be done with the same procedure.

#### 5.2.3.1 Limit upper end position - Shelf-Stop «S 04»

To define a Shelf-Stop position, proceed as follows:

1. Keep the buttons and pressed simultaneously for 4 seconds.  
→ The display shows «S 01», while the «S» is blinking.
2. Press the button or until «S 04» is selected.
3. Confirm the selection «S 04» with the button **M**.  
→ The display stops blinking.
4. Press the button or to drive to the desired Shelf-Stop position.
5. Confirm with the button **M**.  
→ The display shows «S 04».
6. Press the button or to leave the menu mode.



#### 5.2.3.2 Limit lower end position – Container-Stop «S 05»











To define a Container-Stop position, proceed as follows:

1. Keep the buttons and pressed simultaneously for 4 seconds.  
→ The display shows «S 01», while the «S» is blinking.
2. Press the button or until «S 05» is selected.
3. Confirm the selection «S 05» with the button **M**.  
→ The display stops blinking.
4. Press the button or to drive to the desired Container-Stop position.
5. Confirm with the button **M**.  
→ The display shows «S 05».
6. Press the button or to leave the menu mode.



### 5.2.4 Setting the shown height on the display «S 06»











The displayed height can be adjusted with this feature.

1. Keep the buttons   and  pressed simultaneously for 4 seconds.  
→ The display shows «S 01», while the «S» is blinking.
2. Press the button  or  until «S 06» is selected.
3. Confirm the selection «S 06» with the button **M**.  
→ The display shows the current height, while the «cm» is blinking.
4. Measure the height of the table.
5. Press the button  or  to adjust the measured height.
6. Confirm with the button **M**.
7. Press the button   or  to leave the menu mode.



### 5.2.5 Changing the displayed unit of measurement (cm/inch) «S 07»

This function can be used to change the height unit on the display from «cm» to «inch» or from «inch» to «cm».

1. Keep the buttons   and  pressed simultaneously for 4 seconds.  
→ The display shows «S 01», while the «S» is blinking.
2. Press the button  or  until «S 07» is selected.
3. Confirm the selection «S 07» with the button **M**.  
→ The display blinks «cm» or «inch».
4. Press the button  or  to select the desired measurement unit.
5. Confirm with the button **M**.
6. Press the button   or  to leave the menu mode.



*The unit of measurement on the display has now been changed from centimeters (cm) to inches (inch) or from inches to centimeters (2.54 cm = 1 inch).*



### 5.2.6 Deactivating / activating the tilt sensor «S 08»

The control box has an integrated tilt sensor, which is activated by default.

The 0° inclination of the control is initialized during initial operation or reset. If the inclination of the control exceeds 2.5° (e.g. inclined table), the control box stops the lifting movement.

After triggering the tilt sensor, the system moves back by 10 mm (0.4"). If the inclination cannot be corrected (e.g. by driving in the opposite direction), a «Reference drive» must be performed.

## ATTENTION



The tilt sensor is not a safety element!  
There is still a risk of injury before the tilt sensor triggers.

### NOTE

In addition to a collision, the tilt sensor can be triggered by various causes. Therefore, the following should be observed:



- Install the control box rigidly before initial operation or reset.  
→ So that the inclination of 0° is properly initialized.
- After the system is moved, the tilt sensor should be reinitialized  
→ Perform a «Reference drive» (see chapter 5.2.9).
- For mobile applications (e.g. table on castors), the tilt sensor should be deactivated.

This function can be used to deactivate the active tilt sensor or to reactivate the deactivated tilt sensor.

1. Keep the buttons   and  pressed simultaneously for 4 seconds.  
→ The display shows «S 01», while the «S» is blinking.



2. Press the button  or  until «S 08» is selected.



3. Confirm the selection «S 0» with the button **M**.

The control gives an acoustic signal to confirm the change;

- If the tilt sensor has been deactivated, the control box will emit 3 signal sounds (short-short-long).
- When the tilt sensor has been activated, the control box will emit 1 signal sound.

4. If the tilt sensor is activated, the message «E dd» appears.  
For the new initialization of the tilt sensor, a «Reference drive» must now be performed.

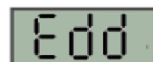









### 5.2.7 Restore memory positions to factory settings «S 13»

With this function it is possible to set all changed memory positions back to factory settings.







**NOTE**

The memory positions will be reset to the pre-saved positions.

1. Keep the buttons   and  pressed simultaneously for 4 seconds.  
→ The display shows «S 01», while the «S» is blinking.
2. Press the button  or  until «S 13» is selected.
3. Confirm the selection «S 13» with the button **M**.  
→ The display stops blinking.
4. Press the button   or  to leave the menu mode.

### 5.2.8 Locking the movement (child protection)

The locking function can be used to lock the control panel of the hand switch to prevent unintentional operation of the lifting system.

By activating the locking function, the lifting system can no longer move. Neither a movement with the buttons  or  nor moving to a memory position    is possible.

The lifting system is in the locked state as long as it is not deactivated.

**ATTENTION**



The locking function is not a safety element and does not avert danger!

**Activate:**

- Keep the buttons   and  pressed simultaneously for 4 seconds.  
→ The control gives an acoustic signal to confirm the activation.

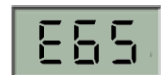

The lifting system is now locked and the display shows «E 65».

If any of the buttons on the hand switch is pressed, a signal tone sound and the system will not move.

**Deactivate:**

- Keep the buttons   and  pressed simultaneously for 4 seconds.  
→ The control gives an acoustic signal to confirm the deactivation.

The system is not locked anymore and can be operated normally.

### 5.2.9 Reference drive – Referencing the end positions

#### ATTENTION



Before the reset, it must be ensured that:





- the lifting element can retract completely.
- the lifting system is loaded with a maximum of 50% of the maximum allowed system load.

If the lifting element cannot retract completely and hits a stop before it reached its lower block position, the zero position is set incorrectly. This leads to a collision when moving up to the upper block position.



#### NOTE

During restoring to the factory settings, the lifting system drives with half the speed.

1. If possible: Drive to lowest position with the button .  
→ This saves time because the system only drives with half speed when doing a reset.
2. Keep the buttons  and  pressed simultaneously to drive the lower block position.  
The system moves downwards at half speed. Upward movement is disabled.
3. After reaching the block position, the system will drive out a few millimeters.  
Afterwards the control box will emit 3 signal sounds.
4. Let go of the buttons  and .

After reaching the block position, the lower and the upper position will be stored automatically.  
The Reference drive is completed.

### 5.2.10 Basic initialization «S 00»

#### ATTENTION



Before the Basic initialization it must be ensured that:

- the lifting element can retract completely.
- the lifting system is loaded with a maximum of 50% of the maximum allowed system load.

If the lifting element cannot retract completely and hits a stop before it reached its lower block position, the zero position is set incorrectly. This leads to a collision when moving up to the upper block position.



#### NOTE

During restoring to the factory settings, the lifting system drives with half the speed.

When restoring the factory settings, the entire system is newly set up again. All settings such as Memory positions or End positions are lost.

1. If possible: Drive to lowest position with the button .
  - This saves time because the system only drives with half speed when doing a reset.
2. If needed, the system can now be rewired
  - d. Remove the cable from the mains.
  - e. Rewire the system: More lifting elements, synchronization cables or safety strips can now be connected.
  - f. Connect the power cable to the mains.
3. Keep the buttons and pressed simultaneously for 4 seconds.
  - The display shows «S 01», while the «S» is blinking.
4. Press the button or until «S 00» is selected.
5. Confirm the selection «S 00» with the button **M**.
  - The control gives an acoustic signal to confirm.
6. Press the button or to leave the menu mode.
  - The display shows «E dC».
7. Do an initial operation according to chapter 4.

## 6 Synchronize 2 control boxes

### 6.1 Cable connections

Up to 4 lifting elements can be connected to one control box SCT iSMPS.

By cascading (synchronizing) multiple control boxes they can be controlled simultaneously with just one hand switch.



With the SYNC-2 cable SCT (124.00183) 2 control boxes can be connected and synchronised.

The length of the SYNC-2 cable is 4'000 mm (157").

The SYNC cable cannot be extended.

If necessary, the motor cables can be extended!

### 6.2 Initial operation of the synchronized systems

1. Connect the motor cables of the lifting elements to the control box in the correct order from **1** to **4**.  
(Automatic plug detection on all sockets)
2. Connect the control boxes using the SYNC-2 cable.
3. Connect hand switch to desired control box.  
Only one hand switch is necessary. The control box with the hand switch is the master control box. All other control boxes are subordinated.
4. Connect the power cables to the control boxes.



**NOTE**

Before connecting the power cable to the mains the following must be verified:  
→ Does the mains voltage correspond to the value on the name plate of the control box?  
→ Are the plugs of the motor cable connected to the correct sockets (**1** to **4**)?  
→ Is the entire lifting system assembled according to the assembly instructions?

5. Connect power cable to the mains.
6. Perform the initial operation according to chapter 4.

## 7 Safety strip – Squeezing protection

### ATTENTION



With lifting systems of Ergoswiss AG it is important to make sure that no objects or people are trapped during the lifting movement.  
Danger of squeezing during lifting movement!

Attach the safety strip to an assumed squeeze zone. If the safety strip gets squeezed while the system moves, the motor will stop instantly and turn back for 5 motor rotations (ca. 15 mm (0.6'')).

The safety strip (124.00157) consists of:

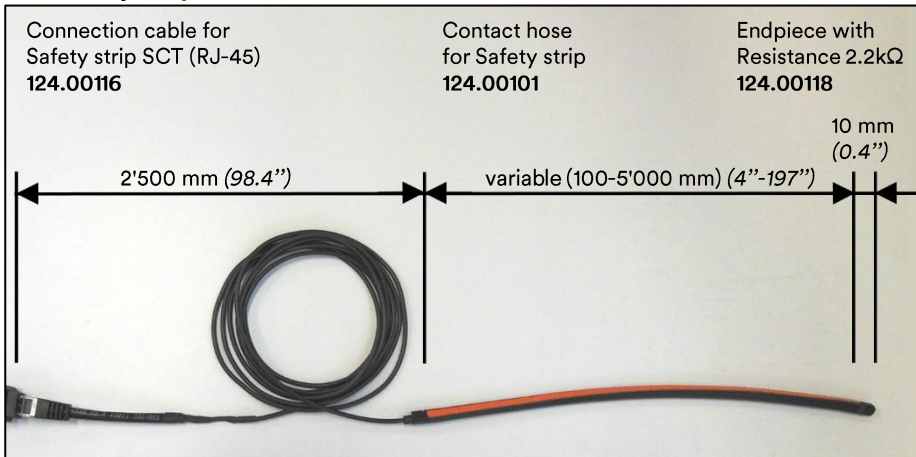

#### Functional properties of the contact tube

Contact angle	< 80 °
Switching pressure	< 25 N bei 23 °C
Switching travel	< 2 mm bei 23 °C
Minimum bending radius	B1 120 mm / B2 150 mm B3 20 mm / B4 20 mm
Max. tensile load	20 N

#### Electrical properties

Terminal resistance	2.2 kΩhm
Max. switching capacity	250 mW
Max. voltage	DC 24 V
Current min. / max.	1 mA / 10 mA

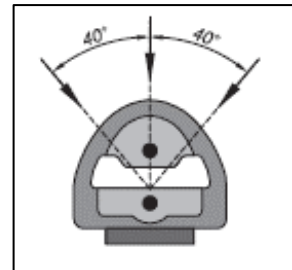
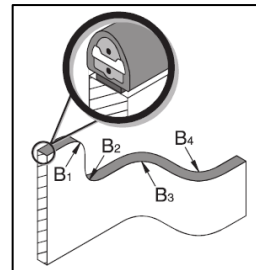

### 7.1 Commissioning

<b>Gluing the contact tube in the squeeze zone</b>	
<ol style="list-style-type: none"> <li>Clean and degrease the contact face.</li> <li>Remove 10-15 cm (4'' to 6'') of protective film from the adhesive surface.</li> <li>Place it on the contact face and press on well.</li> <li>Repeat steps 2 and 3 until the contact tube is completely glued on.</li> <li>Maximum adhesion is reached after 24 h.</li> </ol>	
<b>Initial operation of control box with the safety strip</b>	<b>Adding the safety strip to existing control box</b>
<ol style="list-style-type: none"> <li>Wire the control box according to chapter 3.</li> <li>The safety strip is connected in step 2.</li> <li>Perform an initial operation according to chapter 4.</li> </ol>	<ol style="list-style-type: none"> <li>Perform a Basic initialization («Init» or «S 00») according to chapter 5.1.14 or 5.2.10.</li> <li>The safety strip is connected in step 2.b.</li> </ol>

## 8 Error codes and trouble shooting

### 8.1 Error codes on the display

Display	Description	Trouble shooting
E 60	Motor voltage supply below the permissible minimum	Check power supply. Connect power cable.
E 61	Total current has exceeded the programmed limit	System overloaded → Remove load from system System jammed → Remove clamped object Motor not connected correctly → Insert the motor cable correctly
E 62	User's input is invalid (Container-Stop or Shelf-Stop cannot be set)	Container-Stop must be defined beneath the Shelf-Stop, and Shelf-Stop must be defined above the Container-Stop (see chapter 5.1.4 or 5.2.3)
E 63	Inconsistent or damaged Motor control parameters recognized	Reprogram the control box → Contact customer support
E 64	Tilt sensor has been triggered (Inclination too high)	1) Undo the tilt. (e.g. by driving in the opposite direction) 2) Perform a Reference drive (see chapter 5.1.13 or 5.2.9)
E 65	Movement blocked (child lock)	See chapter 5.1.12 or 5.2.8
E 66	Safety strip was triggered	Remove jammed object
E 69	Safety strip is missing	Connect or replace the safety strip
E 6F	Lifting movement monitoring	System overloaded → Remove load from system System jammed → Remove clamped object Motor not connected correctly → Insert the motor cable correctly
E 71	Hall sensor → wrong motor direction	Contact customer support
E 73	Motor missing → no electricity	Check whether all motor cables are plugged in correctly
E 74	SYNC cable not recognized	1) Check if SYNC cable is plugged in. 2) Perform a Basic initialization «Init» or «S 00» (see chapter 5.1.14 or 5.2.10)
E 78	Over-current on a motor	System overloaded → Remove load from system System jammed → Remove clamped object Motor not connected correctly → Insert the motor cable correctly
E 79	SYNC error (Connection error)	1) Check if SYNC cable is plugged in. 2) Perform a Basic initialization «Init» or «S 00» (see chapter 5.1.14 or 5.2.10)
E 80	Battery Check in progress	Wait a few seconds and until the operation can be resumed.
E 7A	Position difference of the motors	Perform a Reference drive (see chapter 5.1.13 or 5.2.9)
E 7C	The control box has the slave role. Commands for motor are not possible.	Perform a Basic initialization «Init» or «S 00» (see chapter 5.1.14 or 5.2.10)

E C9	Lock due to Duty cycle monitoring. The maximum operating time has been reached.	To protect against overheating, operation is blocked in the following minutes. Wait a few minutes until the drive has cooled down, then the system is ready for operation again.
E CC	Motor turns faster than expected by the control box	Contact customer support
E D5	Motor position is not transmitted to control	1) Connect the motor cable. 2) Perform a «Reference drive» (see chapter 5.1.13 or 5.2.9)
E D7	Short circuit on one or more motor channels	Contact customer support
E D9	Motor current sensor or driver defective	Contact customer support
E DB	User has set limits incorrectly	Contact customer support
E DC	Control box must be restored to factory settings	Perform a Basic initialization «Init» or «S 00» (see chapter 5.1.14 or 5.2.10)
E DD	Control box must be reset	Perform a Reference drive (see chapter 5.1.13 or 5.2.9)

## ATTENTION



If the system malfunctions, do not open any system components!  
Risk of electrical shock!  
Contact customer service.



## 9 Maintenance, cleaning and disposal

The lifting system is maintenance-free during normal operation throughout its entire lifespan.

### ATTENTION



The control box and the hand switch must only be cleaned with a dry or damp cloth. Before cleaning, the power cable has to be separated from the mains!  
No liquid is allowed to enter the plug connections!

Repairs must only be conducted by specialists. Only original replacement parts may be used. For all repair work the system must always be unloaded and voltage-free.

### ATTENTION



In no case may the control box be opened! There is the risk of an electrical shock!

When decommissioning and disposing of the lifting system the electronic parts must be disposed of separately. The system consists of components that can be fully recycled and thus they are quite safe from an environmental protection perspective. The electronic parts comply with the RoHs directive.

The lifting system is not covered by the Electrical and Electronic Equipment Act (WEEE Directive 2012/19/EU).

Lifting systems from Ergoswiss AG are intended for installation in an overall system (e.g. assembly table) and classified under the category of incomplete machines in accordance with the Machinery Regulation (EU) 2023/1230.

Therefore, these systems are not intended for private use.

## 10 Declaration of Incorporation



Ergoswiss AG  
Nöllenstrasse 15a  
9443 Widnau  
Schweiz

Tel. +41 (0) 71 727 0670  
Fax +41 (0) 71 727 0679  
info@ergoswiss.com  
www.ergoswiss.com

### EG Declaration of Incorporation in the sense of the Machinery Regulation (EU) 2023/1230 annex V, Part B

We hereby declare that for the incomplete machine „spindle lifting system”, for ergonomically height adjustable workplaces or similar, with the variants

Lifting system SLA xxxx SCT	(Art. Nr. 903.xxxxx)
Lifting system SLG xxxx SCT	(Art. Nr. 904.xxxxx)
Lifting system SE xxxx SCT	(Art. Nr. 908.xxxxx)
Lifting system SQ xxxx SCT	(Art. Nr. 907.xxxxx)

the following essential requirements of the Machinery Regulation (EU) 2023/1230 are applied and complied with:

1.1.2.; 1.1.3.; 1.1.5.; 1.1.6.; 1.2.; 1.3.2.; 1.3.4.; 1.3.9.; 1.5.1.; 1.5.3.; 1.5.4.; 1.5.7.; 1.5.8.; 1.5.9.

In particular the applied harmonized standards:

EN 1005	Safety of machinery: Physical performance
EN ISO 12100	Safety of machinery: 2011
EN 60335	Safety of electrical appliances for household use (110V version: UL 60950)
EN 61000	Electromagnetic compatibility: EMC (110V version: FCC Part 15 Class A)

specific technical documentation have been created in accordance with annex IV, part B, and will be sent to the national authorities by registered letter or electronically, if the request is justified, and this incomplete machine is in conformity with the relevant provisions of other EU Directives and Regulations:

89/391/EG	Safety and health of workers
2023/988/EU	Regulation on general product safety
2014/30/EU	Directive on electromagnetic compatibility
2014/35/EU	Low voltage directive

Furthermore, we declare that this incomplete machine may only be commissioned if it has been determined that the machine in which the incomplete machine is to be installed complies with the provisions of the Machinery Regulation (EU) 2023/1230 and our assembly and service operating instructions have been followed.

Widnau, 26. November 2025  
Martin Keller  
Managing Director / CEO

Document responsibility EU:

Ergoswiss Deutschland GmbH  
Kronenstrasse 1  
DE-72555 Metzingen