

# Valli



## A symbol for connection<sup>1</sup>

Valli's malleable design embodies the fluid needs of contemporary work spaces. A research-based sofa collection offering visual and audio privacy conducive to tranquility in some instances, and in others, fostering the causal encounters that make good workplaces great.

sciiavello

## Knowledge-led innovation

---

Schiavello's future-focused design philosophy is founded on extensive research conducted by our Schiavello Design Studio and People and Culture Consulting teams. Led by strategic insight into how businesses and employees function, these products help achieve goals and solve problems within the workspace furniture industry.



## Contents

Designer  
1 — 2

Work Spaces  
3 — 4

Valli Sofa Collection  
7 — 20

Features  
21 — 22

Specifications  
23 — 28

ColourLab  
29 — 30

# Inspired by nature. Designed for the workplace.

Mirroring the peace and tranquility found in the quiet depths of a mountain valley or uninhibited cave, Valli, – pronounced Var-ley – offers a welcomed moment of pause in the atmospheric workplace.

The collection's side walls descend gracefully yet imposingly, providing a sense of enclosure and sound absorption. Visually, the signature stitch detail traces Valli's contoured form as a river might cut through a landscape, leading the eye to appreciate it from multiple angles.

Valli is a new world: close in proximity but distant in energy, providing a dedicated space for whatever serves one best: creativity, collaboratively or rejuvenation.



# SCHIAVELLO *DESIGN STUDIO*

The Schiavello Design Studio is made up of a number of multi-disciplinary designers and engineers with expertise in industrial design, interior design and product engineering. Supported by an array of trade-based professionals, the technically focused team brings a diverse expertise to new and evolved product development.

Maintaining thoughtful, innovative and research-driven outlooks on workplace design, the Schiavello Design Studio has been the driving force behind a number of the company's most successful solutions. The most notable concepts include Krossi – the first and only Australian made and designed sit/stand desk – in 2013, the pioneering Climate malleable workplace system in 2010, and the industry-leading acoustics 'room within a room', Focus Quiet Room collection in 2019.

Now, introducing the latest sofa collection Valli in 2022, the studio continues to develop solutions catering to changing typology, business and people needs and technology requirements. All while maintaining product quality, longevity, effortless visual appeal and environmental sustainability.

---



### Transition Space

Circulation paths between spaces optimise information exchange within the workplace community. These serendipitous places allow for impromptu moments to pause, meet or converse.

# Spaces within the new workplace

The new purpose of the workplace is to bring individuals and teams together in an environment that intuitively fosters connection, wellbeing and productivity.

A collection of complementary spaces, varying in purpose and function, enable a broad scope of activities based on today's diverse needs.

Each of our research-led products have been designed in consideration to this holistic framework. Together contributing to a balanced and thriving workplace.

### Retreat Space

A refuge away from the action in order to focus, relax and reflect. A space that allows confidential discussions and focused work. Utilised by individuals without an assigned work point to connect or focus.

### Community Space

A collective space supporting semi formal or spontaneous interaction. A place for co-workers to have lunch or a coffee catch up and to connect. A place for teams to network or socialise.

### Meeting Space

Teams gathering to present and share information. A space to learn and interact physically and virtually. These spaces can be flexible to accommodate diverse gatherings of teams.

### Resident Space

The resident space supports task and team based work allowing people to connect and collaborate. A collection of integrated spaces, providing choice over how and where you work to suit the needs of group and the individual in a collegial environment.

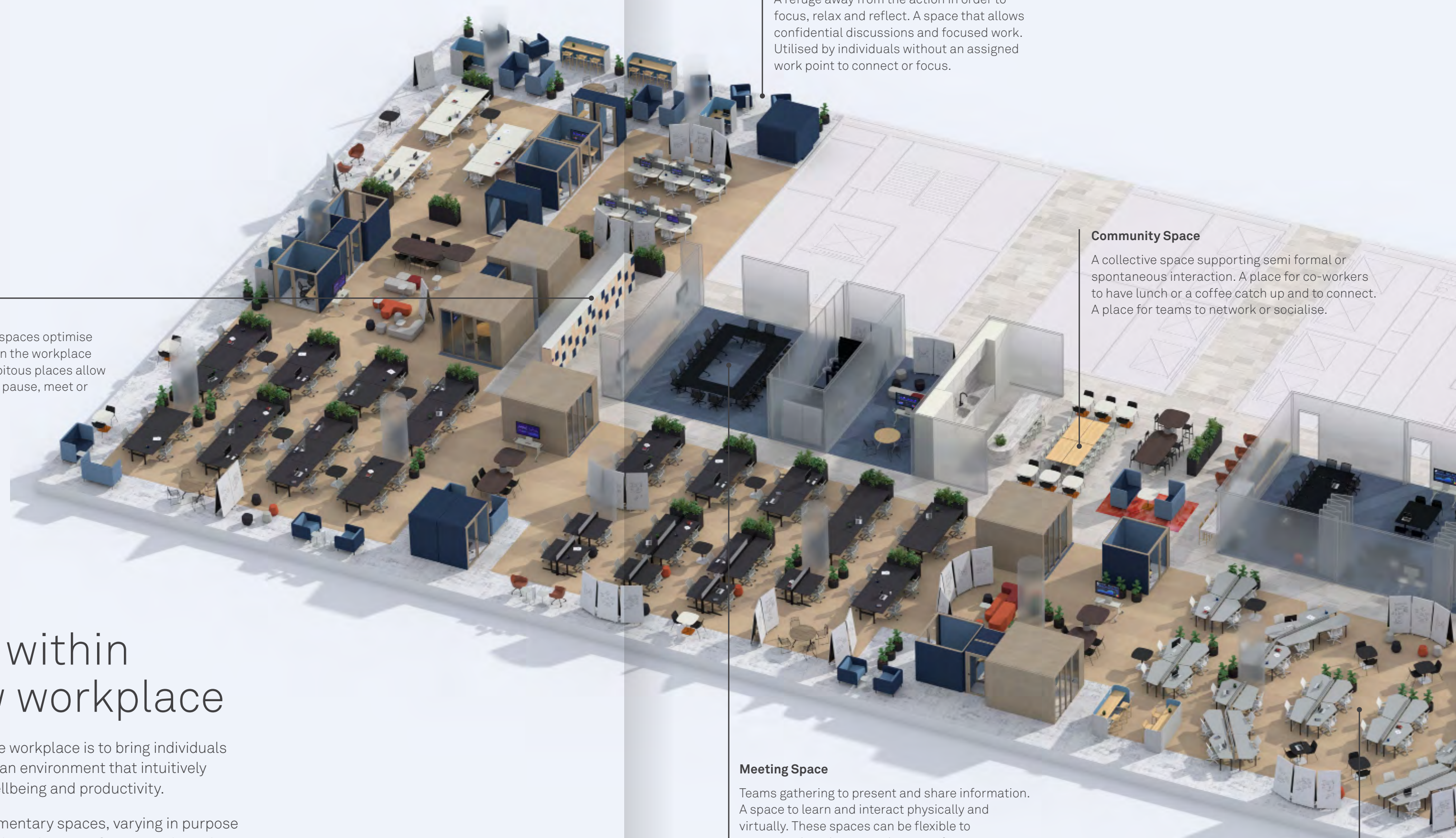

# Introducing Valli Sofa Collection



## An open invitation to converge and contemplate

Valli is the latest line demonstrating Schiavello's extensive research into movement and psychology, ever centred on understanding and supporting human behaviour in the workplace. To this end, the collection accommodates a range of uses, easily adapted from an incidental laptop perch to a semi-enclosed conversation zone, or welcoming waiting lounge. Its upholstery extends an open invitation to converge and contemplate.



# Change is not resisted but optimised

With its versatile form, the collection responds to its placement. Whether nestled straight-backed against a wall or positioned as a centrepiece for the hub of office life, the Valli collection is endlessly adaptive. A curated Valli collection can be used to efficiently delineate between key work zones, such as Community and Retreat, and even customised to evoke the distinct tone of an Executive Suite if desired. The collection recognises a time in the workplace where change is not to be resisted but optimised.





## Prosper beyond the desk

The optional addition of power charging points enables productivity to prosper beyond the desk. The seamless integration of these points celebrates both physical connection to colleagues in the workplace mindful of today's remote working reality, and providing an opportunity for digital connection.



## Moves with you

Portable by design, Valli enables agile adaptability and ease of movement. Developed by Schiavello for maximum functionality and efficiency, Valli Drift's exclusive custom castor glides enable responsive reconfiguration at any point in time – whether it be for a team discussion, group presentation or solitary, focused work. In this way, these non-fixed pieces are a versatile solution, able to set and reset the pace of a workplace.

Inspired by the precise detail of tailored clothing, the inset stitching detail has been applied with exacting perseverance, despite the pliant stretch of the fabric. The subtle colour contrast of the trim guides the eye along the solid arms, before cascading down, grounding the seating in place.



# A mediator between connection and concentration

Every crafted, considered detail in the collection has been derived – through the principles of malleable design – to empower the diverse and fast-changing needs of contemporary work spaces.

**Valli Cove** – In busy open spaces, take a moment to pause, enveloped in the tactile, insular comfort of expertly upholstered walls. This visual and audio privacy supports both quiet conversation and solo focus.

**Valli Drift** – Socially charged and engaging, a seat here is an open invite to connection and conversation. It's to-the-floor upholstery design encases custom caster glides to enable easy movement.

**Valli Float** – Effortless and inviting, these portable pieces provide an easy place to sit, connect and engage. It's research-led ergonomic design provides a structured comfort conducive to clear thinking.

Brought to life with Schiavello's own ColourLab selection of tactile fabric and leather upholstery options, and feature trim colour combinations. With the added choice of powder-coated steel legs or custom castor glides, a myriad of customisation possibilities only enhance Valli's adaptable nature.



# Features

The 'structured comfort' approach is achieved with ergonomic considerations, including tested height from floor dimensions, back support and armrests that allow for various seating positions.

The choice of how the finishes selected across all elements come together is yours – with extensive material combinations, castor or powder coated leg and integrated power options available.

This collection has been developed in alignment with Schiavello's sustainability values complying with GECA.

Integrated power



Feature trim



Ergonomic support

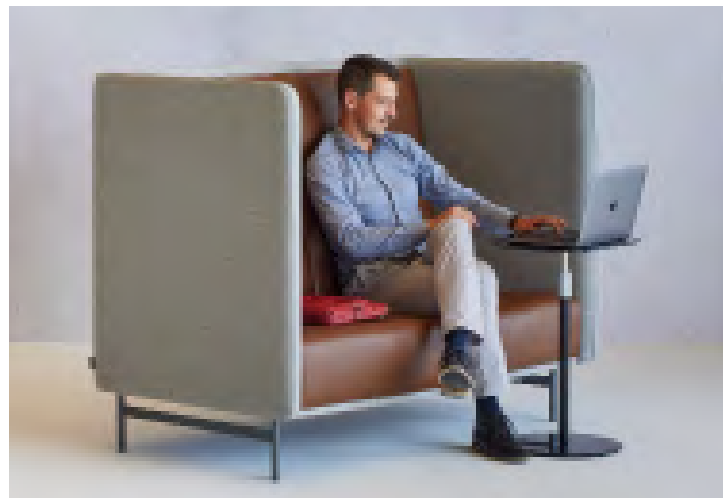

Castor glides

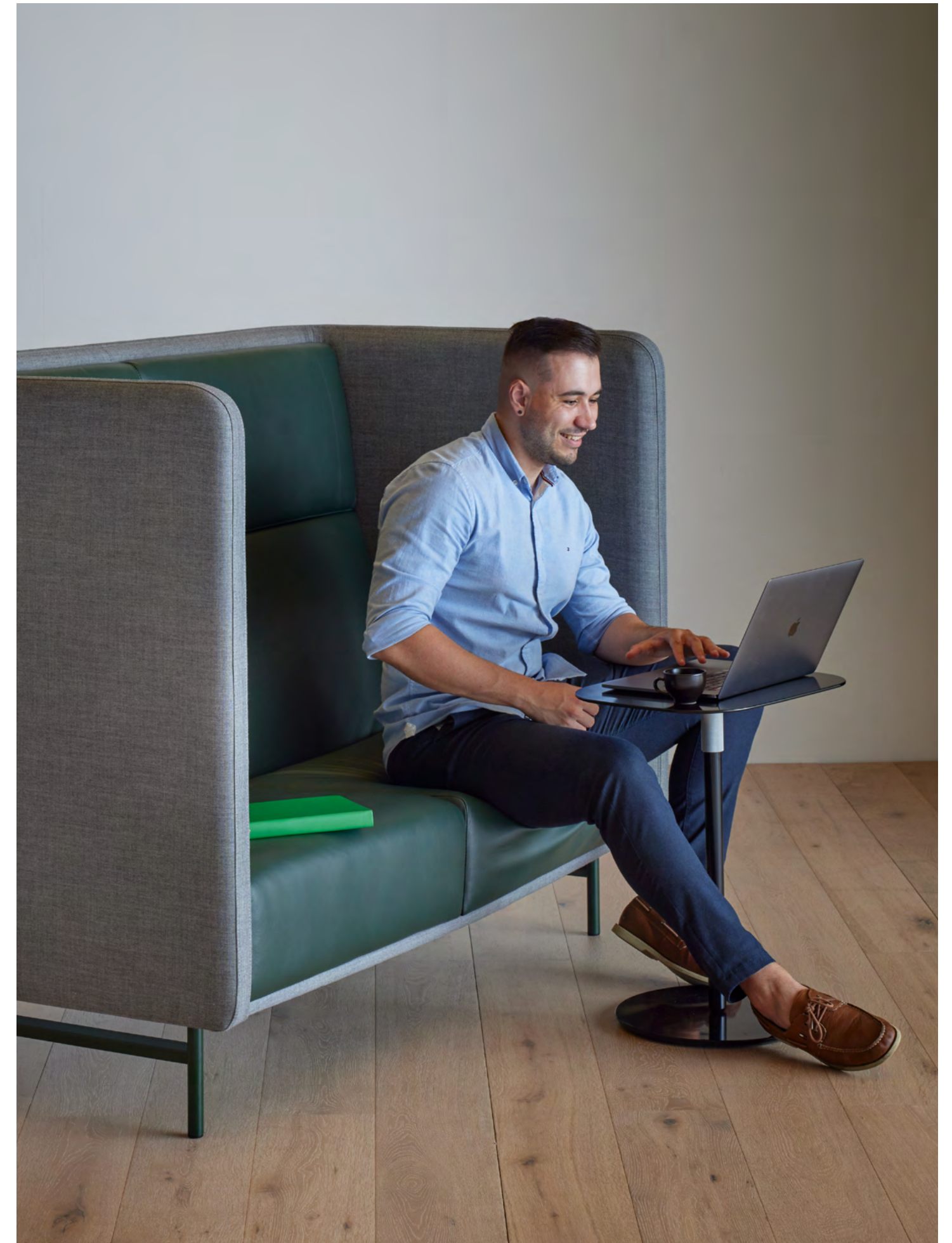

# Specifications

# Specifications

Functionality and versatility lies at the heart of the design.  
Available in low and high back and one, two or three seaters.

## Cove

### Cross section

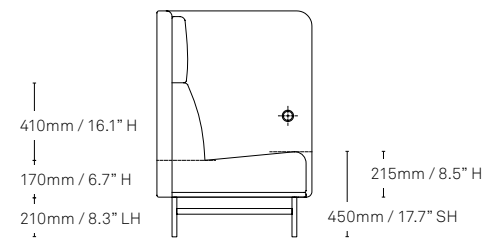

### One-seater

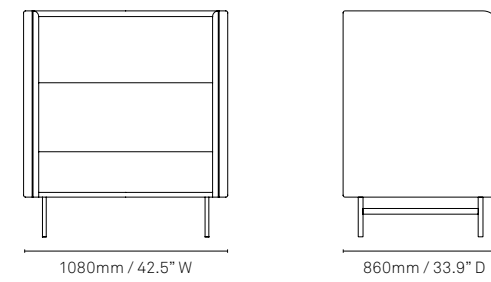
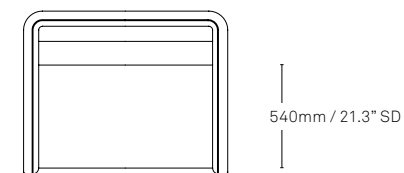

### Two-seater

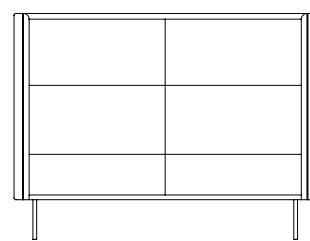
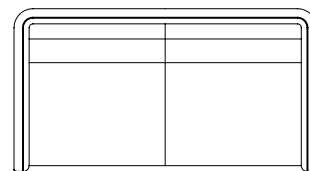

### Three-seater

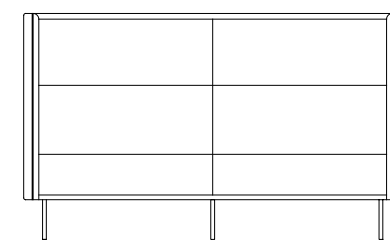
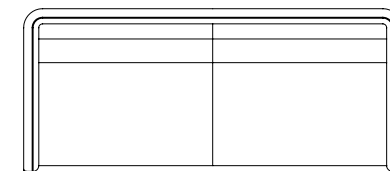

## Float

### Cross section

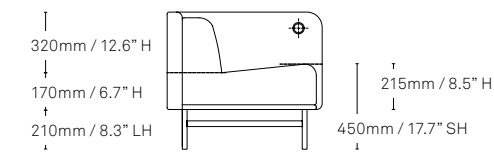

### One-seater

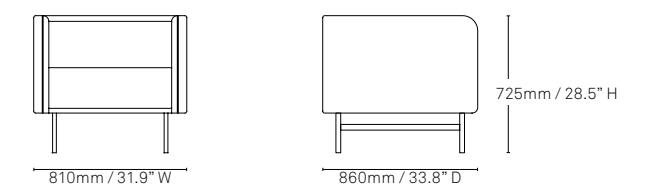
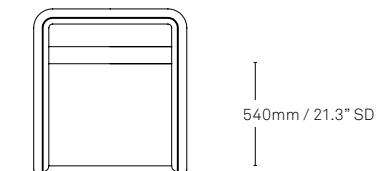

### Two-seater

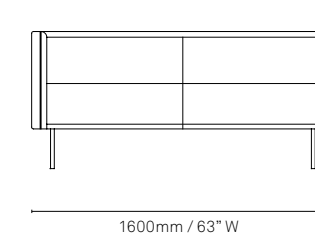
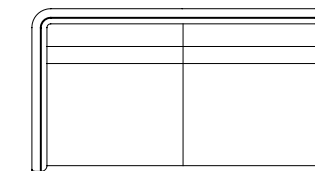

### Three-seater

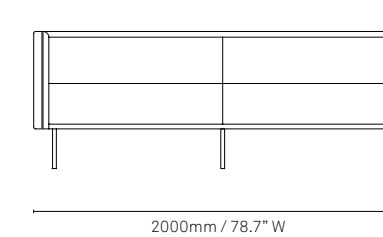
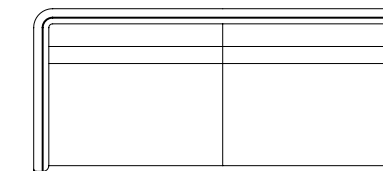

**Drift**

Cross section

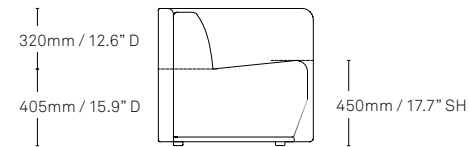

One-seater

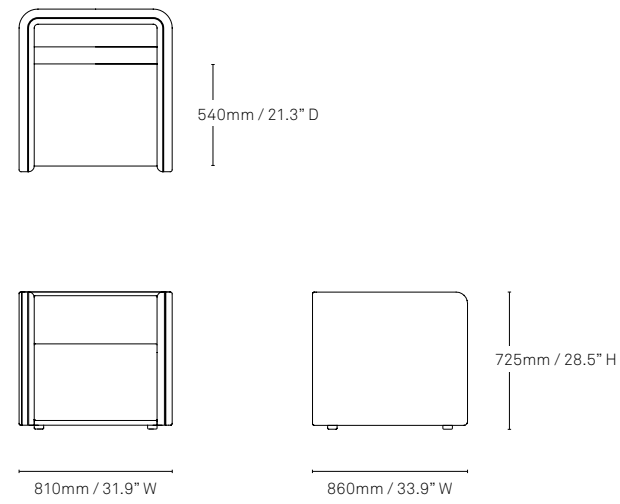

Two-seater

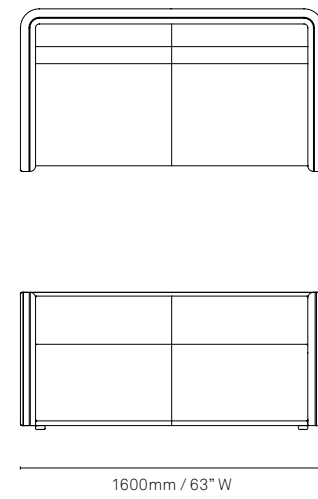

Three-seater

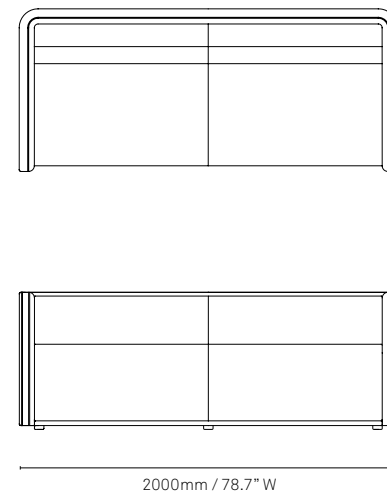

# ColourLab

# ColourLab

Curated by Giulio Ridolfo and developed by Schiavello, Colourlab brings a considered and cohesive palette of finishes suited to the needs of working and living environments. The palette beautifully balances colour, texture and layering across a variety of materials.

To review complete list of Valli finishes please [click here](#).

---

## ColourLab materials and finishes

1. Laminate
2. Timber Natural
3. Timber Paint
4. Timber Wash
5. Leather
6. Fabric
7. Metal Powder Coat

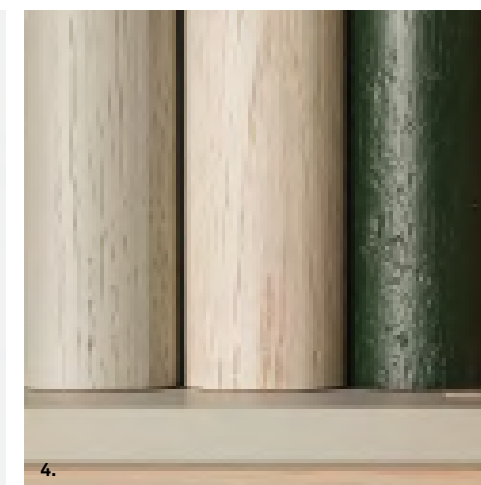



## Ecology and sustainability

Schiavello's most important commitment to sustainability is the company-wide Environmental Management System under ISO 14001. The environmental design principles realised means we design for the environment, focusing on efficient energy use and minimum emissions, longevity and durability, re-use and recycling of our products.

Our principles of ME WE (Materials, Energy, Waste Emissions) give us a simple way to think about how our operations impact the environment.

Printed on an Australian made paper stock that is PEFC Certified and made from elemental chlorine-free bleached pulp sourced from sustainably managed forests and non-controversial sources. It is manufactured by an ISO 14001 certified mill using renewable energy sources.



FS 604920 EMS 604919

## About Schiavello

Schiavello is a multi-disciplinary company dedicated to developing intelligent, inspiring, ecological and resilient solutions for the office, the home and public spaces.

Schiavello's concepts and products are developed in Australia by applying a design process that brings together the company's core design principles and engineering with the creativity of local and international designers.

The Schiavello head office and world-class manufacturing facilities are integral to our continually developing rich tapestry of knowledge. This knowledge ultimately assists us in informing the right solutions and tools for each organisation's needs and people, allowing us to consistently achieve our philosophy that 'Anything is possible'.

To find a Schiavello showroom or partner in your area, please visit <https://schiavellofurniture.com>

All intellectual property rights and copyrights are reserved. Nothing contained in this brochure may be reproduced without written permission. Schiavello Group Pty Ltd reserves the right to change any or all details without prior notice. All dimensions stated within this document are nominal and/or approximate only and subject to variation.

SCH/BVALLI23-C

**1 – Connection**

*Noun*

a relationship in which a person or thing is linked or associated with something else.

**2 – Connected**

*Adjective*

Brought together or into contact so that a real or notional link is established.



Valli: a tailored solution to compliment the fluid needs of the contemporary workplace.

<https://schiavellofurniture.com/products/valli-cove>