

Glass Systems and Solutions

Price List 29A

Effective December 16, 2019



Table of Contents

Introduction	Contact Information	iii
	Finish Codes	iv
	Product Shipping Schedule	v
	Warranty Policy	vii
	Terms of Sale	viii
	Application Guide	ix
DRS Rails, Channels and Accessories		1
Center Hung Patch Fittings and Designer Pivots		39
Offset Hung Patch Fittings		65
Headers and Accessories		71
Closers and Hardware		91
Locksets for Glass Doors		109
Pulls and Handles		123
Sliding Systems		139
MANET Pivoting/Sliding Door Systems		205
Panic Hardware		225

Contact Information

dormakaba USA, INC.
Dorma Drive, Drawer AC
Reamstown, PA 17567-0411

Office Hours

Monday–Friday
8:00 AM to 6:00 PM EST

Phone

800-523-8483
717-336-3881

Email

glassorders.us@dormakaba.com

Email requesting quotes

glassestimates.us@dormakaba.com

FAX

888-238-4401



Finish Codes

	dormakaba GMBH Finish #	Ref. dormakaba USA Finish #	BHMA Equivalent	Reference dormakaba Code
Anodized Aluminum Parts				
Mill	100	719	719	ML
Clear	101/150	628	628	CL
Anodized Brass	105	606	606	SB
Similar to Stainless Steel	107/113	107/113	670	SSS
Dark Bronze	108	710	710	DB
Black	109	711	711	BK
Aluminum Color	114	718	718	EV-1
Polished Chrome	122	625	672	ARC
Special Anodized	199	199	—	SA
Brass				
Polished Brass with Lacquer	502	605	605	PBL
Polished Brass without Lacquer	503	—	—	PB
Satin Brass without Lacquer	599	728	728	SB
Polished Nickel	618	618	618	PN
Satin Nickel (Similar to Satin Stainless)	619	619	619	SN
Steel or Stainless Steel				
Satin Chrome Plated	500	626	626	SC
Polished Chrome Plated	501	625	625	PC
Satin Stainless Steel	700	630	630	SS
Polished Stainless Steel	701	629	629	PS
Bronze				
Satin Bronze without Lacquer	600	612	612	SBZ
Polished Bronze without Lacquer	601	611	611	PBZ
Dark Bronze Oxidized, Oil Rubbed	602	613	613	10B
Special Clad (Plating)				
Special Clad (Plated) Finish	299	299	—	SPL
Painted or Powder Coated				
Primer	314	600	600	PR
Special Paint/Powder	399	999	—	SF
Aluminum	689	689	689	SBZ
Dark Bronze	690	690	690	PBZ
Satin Bronze	691	691	691	10B
Black	693	693	693	BK
Dark Duranodic Bronze	695	695	695	DB
Gold	696	696	696	—
Plastic Parts				
Black	803	693	693	BK
Similar to 101/150 Clear	807	689	—	—
Similar to Satin Stainless	808	—	—	—

List \$

Finish Sample	Item # 925.001 (includes finishes 101, 108, 109, 503, 599, 600, 601, 700, 701)	30
----------------------	--	----

NOTES:

- Custom powder or paint finishes ordered as 399 or 999, non-standard cladding ordered as 299, or non-standard anodizing ordered as 199 must be approved by dormakaba prior to quoting. Not all custom finishes are possible at the published list prices. If a non-standard finish request is approved by dormakaba for processing, a quote will be required.
- dormakaba always reserves the right to refuse any custom finish order.
- Finish # is dormakaba's numerical representation within the part number.
- Please contact factory for special finishes.
- Note that full length finished extrusions may include clamping marks to be cut off in field prior to installation.
- dormakaba finishes are representative of industry recognized BHMA or other finishes. Exact match from dormakaba to a base metal finish, a competitors product, or from lot to lot is never guaranteed.

Product Shipping Schedule

Key	Orders received by 2:00 PM EST	Mon.	Tues.	Wed.	Thurs.	Fri.
①	Non-Fabricated items ship in 1 business day	Tues.	Wed.	Thurs.	Fri.	*Mon.
③	Standard Fabricated and Non-Standard Fabricated items ship in up to 3 business days	Thurs.	Fri.	*Mon.	*Tues.	*Wed.
⑤	Custom Fabricated items ship in up to 5 business days	*Mon.	*Tues.	*Wed.	*Thurs.	*Fri.
SO	Special Fabricated/Finishes and Special Order items	up to 5 weeks				
SW	Special Order custom product globally sourced from dormakaba factory	up to 8 weeks				
Q	Quote —Lead time and pricing quoted on individual basis	quoted lead time				

* Indicates the following week.

NOTE: Above fabrication schedule is based on 10 fabrication items per order. For fabrication orders over 10 per order, contact Customer Service for a custom schedule.

①	NON-FABRICATED	<ul style="list-style-type: none"> Select Patch Fittings and Accessories; see individual price pages for details. RTS88 and BTS80 Closers and Accessories in limited finishes. Select Handles; see individual price pages for details. (Excludes custom handles.)
③	STANDARD FABRICATED	<ul style="list-style-type: none"> Select DRS Rails and Accessories; see individual price pages for details. (Excludes Miters.) Select DRS Dri-Fit™ Sidelite rails; see individual price pages for details. (Excludes Miters.) Select 4-1/8" or 4-1/2" Headers; see individual price pages for details. (Excludes Miters.) NOTE: All headers are shipped with closers installed unless supplied from select service or requested otherwise. U-Channels and Dri-Fit™ Channels, any length. Select Mechanical Channel components; see individual price pages for details. Select Manual Slider Systems; see individual price pages for details. (Excludes Syncro & DORMOTION.)
③	NON-STANDARD FABRICATED	<ul style="list-style-type: none"> Select 4-1/8" or 4-1/2" Headers fabricated to special lengths (standard 2-3/4" pivot point, standard finishes). NOTE: All headers are shipped with closers installed unless supplied from select service or requested otherwise.
⑤	CUSTOM FABRICATED	<ul style="list-style-type: none"> Miters (DRS Rails, Headers, Dri-Fit™ Sidelites and U-Channel) at any length and any angle. EMSL 2765 Shear Locks installed in DRS Rails and/or Headers (standard or non-standard Fab lengths).
SO	SPECIAL FABRICATED/ FINISHES	<ul style="list-style-type: none"> Special pivot point preparations, other than 2-3/4" pivot point, DRS Rails and/or Headers). Vertical Stile, Floating Header, Offset Pivot preparation and/or installation.
	SPECIAL FABRICATED/ FINISHES	<ul style="list-style-type: none"> Orders requiring competitor (non-dormakaba) hardware preparation or installation are scheduled on a project basis once all competitor product/templates are received. Allow up to five (5) weeks from that point. HSW/FSW systems see notes below.
SO	SPECIAL ORDER	<ul style="list-style-type: none"> Special finishes will be scheduled based on required process capacity. Allow up to five (5) weeks. Paint/Powder Coat capacity based on back log; last in last out (LIFO) at time of purchase order. Allow up to five (5) weeks. <p>No returns accepted on special order items.</p>
SW	SPECIAL ORDER	<ul style="list-style-type: none"> Custom product will be scheduled based on required production capacity from a global dormakaba factory. Allow up to eight (8) weeks. <p>No returns accepted on special order items.</p>
Q	QUOTE	<ul style="list-style-type: none"> Quote — Lead time and pricing quoted on individual basis.

Orders

- We reserve the right to decline the whole or part of orders in which price, finishes, quantity of goods, or credit status of the buyer is not satisfactory to us.
- We reserve the right to discontinue items or change specifications at any time without notice and without incurring any obligations.
- dormakaba cannot be held liable for extended delivery dates that may result in the cancellation of an order.
- Minimum order of \$50.00 (net invoice before shipping or other charges).
- HSW/FSW and custom finished MUTO Telescopic system lead-times are quoted at time of order. Lead-times will vary based on the complexity of the order.
- Order scheduling is based on capacity at time of order.

Material Finishes

- Custom powder or paint finishes ordered as 399 or 999, non-standard cladding ordered as 299, or non-standard anodizing ordered as 199 must be approved by dormakaba prior to quoting. dormakaba always reserves the right to refuse any custom finish order. Please contact factory for special finishes.
- Not all custom finishes are possible at the published list prices. If a non-standard finish request is approved by dormakaba for processing, a quote will be required.
- Any custom powder or wet coat orders (399 or 999) will include a net charge of \$200 per purchase order.
- Finish numbers are dormakaba's numerical representation within the part number. dormakaba finishes are representative of industry recognized BHMA or other finishes. Exact match from dormakaba to a base metal finish, a competitor's product, or from lot to lot is never guaranteed.
- Note that full length finished extrusions may include clamping marks to be cut off in field prior to installation.

Terms of Sale Prices

- All prices shown are in U.S. Dollars and are subject to change without notice.
- All prices quoted here are exclusive of transportation, insurance costs, duties, and any taxes. Buyer agrees to pay all taxes unless Buyer has provided dormakaba USA with an exemption resale certificate in the appropriate form for the jurisdiction of Buyer's place of business and any jurisdiction to which Products are to be directly shipped, or unless the sale is otherwise exempt from these taxes. Buyer agrees to indemnify and hold dormakaba USA harmless for any liability for tax in connection with the sale, as well as the collection or withholding thereof, including penalties and interest thereon.
- Prices on acknowledged orders are firm for shipment within three months of order date.
- All other orders subject to price in effect at time of shipment.

Order Entry

For optimal production lead please provide as all required information on your purchase order or order forms.

- Production timeline starts once a clean order is received and if necessary, customer signoff is provided. Published lead times and promise dates do not account for time delays stemming from customer requirements (drawings, approvals, etc.).
- Orders will be entered once all relevant details have been received, which results in a clean order (part numbers, glass thickness, cut dimensions, finish codes, customer drawings and templates, resulting customer sign-off if required, and any other pertinent information). Any delay in obtaining these details will delay order entry and acknowledgement.

Acknowledgments

Acknowledgements are exact copies of the manufacturing order and should be checked upon receipt. If acknowledgement is incorrect, please notify dormakaba Customer Service immediately.

Order Changes

1. Non-Fabricated: changes may be made up to 4 business hours after the order is acknowledged, unless the order has been packed. Changes, regardless of the timing, may result in order rescheduling. Orders canceled more than 4 hours after order acknowledgment will incur a 50% minimum restocking fee (except when published lead time is more than 3 days).
2. Standard or Non-Standard Fabricated: changes may be made up to 24 hours after the order is acknowledged, or later if production/fabrication of the order has not started. Changes or cancellations are subject to rescheduling and change fees, based on order progress and un-recoupable production costs at time of request. Charges determined at dormakaba's discretion.
3. Custom & Special Fabrication/Finishes: changes may be made up to 24 hours after the order is acknowledged, or later if production/fabrication of the order has not started. Changes or cancellations are subject to rescheduling and change fees, based on type of change requested, order progress, and un-recoupable production costs at time of request. Charges determined at dormakaba's discretion, up to the full acknowledged order pricing.

Shipping

- FedEx will ship a maximum of 130 united inches (length + circumference) @ 108" maximum length.
- Accelerated shipping is available at customer expense. Orders are not guaranteed to ship same day.
- dormakaba is committed to using the most efficient method of shipping orders unless otherwise specified.
- Additional expenses to dormakaba as a result of special packaging request from customer will be added to the customer invoice & may extend lead time.

Delivery

Ship dates are contingent upon conditions at time of acknowledgement and can be subject to delays due to strikes and/or other labor issues, material shortages, equipment failure, fire, flood, or other acts of God, or causes beyond our control. dormakaba is not liable under any circumstances for consequential damages arising from such delays.

Freight Policy

All goods are shipped F.O.B. Reamstown, PA. Shipments will be prepaid and charges added to the invoice for customers with

accounts and COD for orders under \$1,000.00 net for non-account holders. Freight charges are prepaid and allowed on any one order to one destination (Mainland U.S.A) by carrier of dormakaba choice, for orders with net price of \$5,000.00 minimum.

Seller makes no representation or commitment as to the time of deliveries and/or installation can be made against this order. Estimated shipment dates and times are a guideline only. Seller shall not be liable for any loss, damage, injury, failure, delay in performance, delivery or installation caused by strikes, riots, war governmental restrictions and regulations, acts of God, or any other resultant conditions beyond the reasonable control of Seller.

Damaged freight is the sole responsibility of the Buyer. It is recommended that the Buyer follow guidelines as provided by the freight carrier, and that visible or suspected freight damage be indicated on the bill of lading at the time of delivery, and claims be filed with the freight carrier within five working days of receipt to avoid potential claim rejection. Additional freight insurance is

available upon Buyer's request and will be provided at the Buyer's expense.

Preparing or Installing Competitor Hardware

Orders requiring competitor (non-dormakaba) hardware preparation or installation are scheduled on a project basis once all required information is received. Allow 5 weeks once all required information (i.e. a clean order) has been submitted. Larger orders will impact lead time.

By ordering product requiring custom (including non-dormakaba hardware) fabrication, the Buyer acknowledges and accepts responsibility to provide the most recent, correct, and applicable templates, drawings and manuals to ensure correct fabrication. dormakaba retains final discretion on competitor hardware that does not match customer-provided documentation and is not liable for any resulting charges or delays.

Anything not on this list is subject to a minimum of 5-week lead time. Competitor prep charges and lead times may be reviewed based on complexity.

Option	Function	Manufacturer	Model	Not Compatible with 2-1/2" DRS Rails *
CMP HDWP	Auto Operator	Besam	SW200i-CP	X
		Horton	4800LE	X
		LCN	Astro Swing	X
			2810-CP	X
		Stanley	Magic Swing	
	Closer	Glynn Johnson	100 Series	X
		Jackson	2011M22	
		LCN	2030-CP	X
			3077-CP	X
			3610-CP	X
			6030-CP	X
		Rixson	28 BTM Arm	X
	554 BTM Arm		X	
	Top, Bottom Pivots, Sets	IVES	7255	
			H340	
		Rixson	340	
			345	
370			X	
587				
CMP E-LOCK	Mag Lock	Dynalock	3002	
		Schlage	M490	
		SDC	1511	
		Securitron	M32	X
			M62	X
	M82			
	M680			
	Mag Lock (Double)	Securitron	DM62	X
	Shear Lock	Locknetics	GF3000/TRD/BRD	X
			280+	X
			422	X
Securitron		SAM B	X	
		SAM2	X	
1224				

Terms

1% 10 Days, Net 30.

Limited Warranty

dormakaba USA, Inc. ("dormakaba" or "Seller") warrants to Buyer (Distributor or Dealer and its agents, employees, successors, installers, technicians, and/or assigns) all products they manufacture to be free from defects in material and workmanship, under normal use and service.

THIS WARRANTY IS MADE EXPRESSLY IN LIEU OF ANY OTHER WARRANTIES, WHETHER EXPRESSED OR IMPLIED, INCLUDING ANY WARRANTY OF MERCHANTABILITY, FITNESS FOR A PARTICULAR PURPOSE, TITLE OR NON-INFRINGEMENT AND IN LIEU OF ANY OTHER OBLIGATIONS OR LIABILITIES ON THE PART OF THE DORMAKABA USA AND THE DORMAKABA USA NEITHER ASSUMES NOR AUTHORIZES ANY PERSON TO ASSUME FOR IT ANY OTHER LIABILITY OR OBLIGATIONS IN CONNECTION WITH THE SALE OF SUCH PRODUCTS BY THE BUYER.

Seller's sole obligation under these warranties, during the period after date of manufacture as listed above, shall be to issue credit, repair or replace any items or part thereof which is proved to be other than as warranted.

Seller shall have the sole right to determine whether such parts shall be repaired or replaced or whether credit shall be issued. No allowance shall be made for any labor charges for replacement of parts, adjustments or repairs, or any other work. In no event shall Seller be liable for collateral or consequential damages.

If goods are claimed to be other than as warranted, seller, upon notice promptly given, will either examine the goods at their site or issue shipping instructions for return to seller (transportation costs prepaid by buyer). These warranties shall not extend to any goods or parts thereof which have been subjected to misuse or neglect, damage by accident, rendered defective by reason of improper installation or by the performance of repairs, modifications or attachment to other products outside of seller's plant.

Because dormakaba has no control over conditions under which its products are used, dormakaba specifically does not warrant the adequacy or sufficiency of any device or recommendations given to buyer. Nor does dormakaba warrant that every dormakaba product complies with every code, standard or regulation in every community except as specifically stated in a published dormakaba catalog or in writing by an officer of the company. Nor is dormakaba bound by the terms of buyer's agreements with other parties.

Warranty Periods

All dormakaba closers that are BHMA certified to ANSI A156.4 Grade 1 Standard for Door Controls-Closers, except U1500 Series, are covered by a 25-year warranty. This includes BTS Series concealed floor closers, except where noted.

All fire/life safety products that are BHMA certified to ANSI A156.15 Grade 1 Standard for Closer-Holder Release Devices carry a 25-year warranty on the closer mechanism and a 2-year warranty on any electrical or electronic component.

The RTS Series overhead-concealed closers carry a 5-year warranty.

All other products not mentioned above carry a 2-year warranty.

All interior wall systems including HSW, FSW, PURE, PURE Enclose, Prive, and Fusion include a five (5) year warranty from date of substantial completion, exclusive of glass, wood doors, labor, or competitors' products or components. All door hardware components within the system such as door handles, electronic locking devices, etc. revert to the original component warranty.

All dormakaba products including MUNDUS, Universal, TENSOR, DRS, Headers, MUTO Premium and Comfort, RS-120, DRS-120, AGILE 150, MANET, BEYOND, and Exit Hardware are covered by a 2-year warranty.

Prior to returning any electronic locking devices, customers must speak with dormakaba technical support to verify the units have been installed correctly.

Limitations

Seller's obligation under this warranty is limited to repair, replacement or issuing credit for any items or parts proven to be other than warranted, which shall be returned to dormakaba USA with transportation charges prepaid and which after examination, prove to be defective.

Seller retains the sole right to determine whether such parts shall be repaired or replaced, or whether credit shall be issued. Seller is not responsible for defects or damages caused by failure to follow manufacturer's instructions and directives, normal use, wear and tear, water damage, variations or disruptions in the power supply, transient voltage, consumable materials, vandalism, civil disorder, fires, storms, floods, acts of God, misuse or abuse.

Seller is not responsible for labor, travel, or other costs and charges arising from product replacement, adjustment, repair or any other work, which are the sole responsibility of the Buyer and are not covered by the terms of this warranty. In no event shall Seller be liable to Buyer for any incidental, consequential, liquidated, exemplary, punitive, or other indirect damages, including without limitation, profits or loss of use damages arising out of the manufacture, sale, supplying, or failure or delay in supplying the products or the services related thereto, whether based upon warranty, contract, tort, strict liability, or otherwise, should not exceed the price paid for the product or service. Said warranty shall not apply to such products which shall have been installed, altered, or repaired by any person not expressly authorized in writing for such purpose by Seller, or subjected to misuse, negligence, or accident. dormakaba is not responsible for defects, damages, injuries or any condition resulting from alteration by any company or entity other than dormakaba. In the event that the Buyer, its agents, employees, successors, installers, technicians, owner, and/or assigns tampers with, misuses, removes any parts, or adds any parts or equipment, Buyer agrees to indemnify, save and hold harmless dormakaba, its agents, employees, successors, and/or assigns, from any and all liability, damages, or losses, including reasonable attorney's fees, arising out of, or incidental to, the aforementioned conduct.

Inspection and Rejection

All products shall be examined by Buyer upon receipt of Buyer. If products are damaged upon receipt or do not conform to agreed specifications, products shall not be moved from point of delivery, and a written claim must be filed with dormakaba USA within 5 business days of date of delivery. Upon receipt of a written claim for damage or nonconforming products, Seller will notify Buyer in writing if products are to be returned, or if products will be repaired or if a credit will be issued. Whether products are returned or repaired or whether a credit is issued, is with dormakaba's full and complete discretion, subject to the limited warranty set forth below, and shall be Buyer's sole remedy at law or equity.

Returned Goods

- Goods determined defective within the terms of our warranty may be returned for replacement. Goods returned due to any other factors are subject to a 35% restocking fee.
- For all returns contact the factory for a "Return of Goods Authorization" number (RGA). All returns must bear the RGA number provided. Unauthorized returns will not be accepted. The complete RGA policy is available upon request.
- All returns must be shipped to:
dormakaba USA Inc.
Returns Department
1 Dorma Drive
Reamstown, PA 17567
- To protect our customers from liability, do not sign the delivery receipt until shipment has been inspected thoroughly.
- Customer is responsible to make necessary notations on the delivery receipt after inspection. Failure to note damaged items and/or shortages on the receipt releases dormakaba from all liability; therefore, customer is responsible for any replacement costs.
- If damage or shortage is noted, please notify your dormakaba customer service representative within 48 hours of receiving your shipment.

Controlling Provisions

To the extent there is a conflict between these Terms and Conditions of Sale and Buyer's purchase order, these Terms and Conditions of Sale shall be controlling.

Governing Law

Any contract between the parties shall be construed and governed in accordance with the laws of the state of Indiana.

Termination

Each purchase order issued by Buyer in connection with Seller's quotation is subject to acceptance by Seller. If Buyer defaults in the payment of any sum due Seller or commits any other breach of any of the terms or conditions herein or if there is a material change in the ownership or financial condition of the Buyer which is considered unsatisfactory to Seller, Seller may, without prejudice to any other rights which may have accrued or which may accrue to it, whether under contract or at law or equity, refuse to accept any purchase order and may terminate any order immediately.

Indemnification

Buyer will indemnify, defend, and hold harmless (including payment of reasonable attorneys' fees and court costs), dormakaba USA's and its employees, agents, and permitted assigns against all liability to third parties that (1) arises from Buyer's negligence or willfully, wrongful, wanton, or reckless conduct that results in death or bodily injury or damage to real or tangible personal property; or (2) arises from or in connection with Buyer's use or resale of any product furnished under this Agreement that violates any third party's trade secrets, proprietary information, trademark, copyright or patent rights.

Application Guide

Type P Door

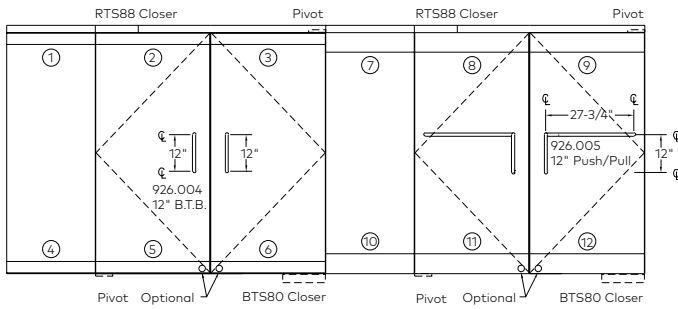

Type BP Door

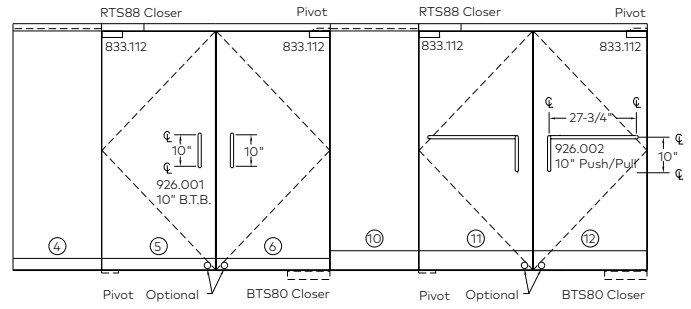

Key

- 1 3-5/8" (92) or 4" (102) DRS Top Dri-Fit® Sidelite Rail (Fixed Panel)
- 2 3-5/8" (92) or 4" (102) DRS Top Rail × 8836 or 8534
- 3 3-5/8" (92) or 4" (102) DRS Top Rail × 355.0 or 355.9
- 4 3-5/8" (92) or 4" (102) DRS Bottom Dri-Fit® Sidelite Rail (Fixed Panel)
- 5 3-5/8" (92) or 4" (102) DRS Bottom Rail × 8852 × with or without Lock
- 6 3-5/8" (92) or 4" (102) DRS Bottom Rail × 355.1 or 7422 with or without Lock
- 7 6" (152) or 10" (254) DRS Top Dri-Fit® Sidelite Rail (Fixed Panel)
- 8 6" (152) or 10" (254) DRS Top Rail × 8836 or 8534
- 9 6" (152) or 10" (254) DRS Top Rail × 355.0 or 355.9
- 10 6" (152) or 10" (254) DRS Bottom Dri-Fit® Sidelite Rail (Fixed Panel)
- 11 6" (152) or 10" (254) DRS Bottom Rail × 8852 × with or without Lock
- 12 6" (152) or 10" (254) DRS Bottom Rail × 355.1 or 7422 × with or without Lock

NOTE: Throughout the Price List, measurements are shown as inches (mm), for example: 3/8" (10).

Type A Door

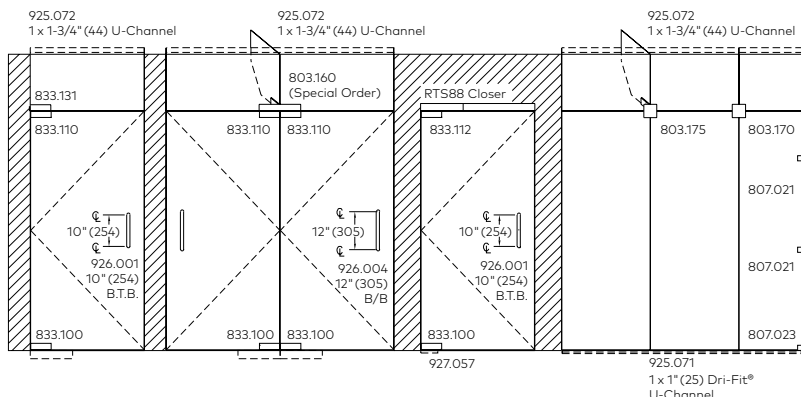
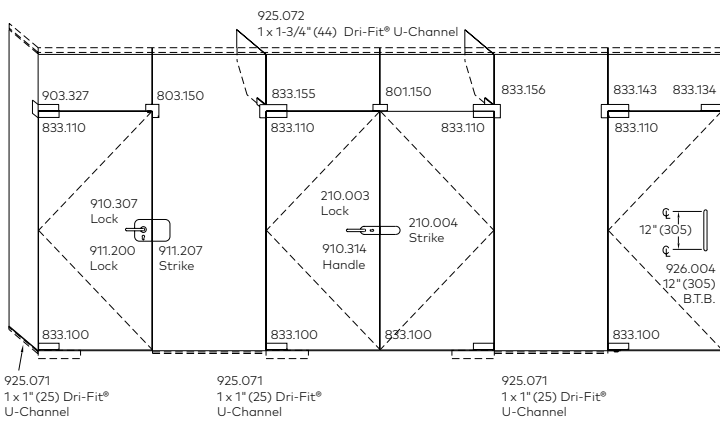

DRS Rails, Dri-Fit® U-Channels, and Accessories

	Select Service	2
DRS Rails	Ordering Guide	4
	Standard DRS Rails (35-3/4")	5
	Top Rails	6
	Bottom Rails	12
	Bottom Rail Locking	17
DRS Accessories and Options	Options and Prep Charges	23
	DRS Rails Covers and End Caps	24
	Vertical Stiles	26
	Weather Brush/Weather Seal	26
DRS Dri-Fit® Sidelite Rails	Ordering Guide	27
	Dri-Fit® Sidelite Rails	28
	Dri-Fit® Options and Accessories	30
	DRS Sidelite Rail Shim	31
	Saddles and Thresholds	31
Glazing and Dri-Fit® U-Channels and Dri-Fit® Sidelite Accessories	Glazing and Dri-Fit® U-Channels and Dri-Fit® Sidelite Accessories	32
	Dri-Fit® U-Channel for 3/8", 1/2" and 5/8", 3/4" Glass	32
	Dri-Fit® U-Channel for End Cap (Snap Fit)	33
	Dri-Fit® U-Channel Gasket	33
DRS Accessories and Options	DRS Rail Locks	34
	Cylinders	34
	BTS Hardware — Offset Arms and Pivots	35
	RTS88 Hardware — Arms and Pivots	36
	DRS Options	36
	Mechanical Channel and End Cap	37
	Polycarbonate Glazing Accessories	38

Select Service Quick Ship – DRS Rails and Accessories

Select service should be used for small quantities of popular dormakaba products that require shipment within 24 hours. The program includes patch fittings, DRS rails, headers, concealed closers and pivots, and pulls and handles. (Customer responsible for shipping costs FOB.)

Subject to Availability

Next Business Day Service (Shipment when Purchase Order is received prior to 4:00 PM EST).

Examples: dormakaba receives P.O. at 3:59 PM on Monday, order will ship by close of business on Tuesday.
 dormakaba receives P.O. at 3:59 PM on Friday, order will ship by close of business on the following Monday.

Notes:

- Standard freight and discount schedules and terms of sale apply. Please refer to the current price list for full details.
- dormakaba reserves the right to limit quantities or decline an order if the credit status of the buyer is not satisfactory to dormakaba.
- Orders cannot be cancelled.
- Select Service Quick Ship available only in the United States.
- All prices are in U.S. dollars.
- Products and prices are subject to change without notice.
- Limited quantities available.

Key

N "New" to Select Service, Available in East and West Coast Warehouse

■ Available in East and West Coast Warehouse

E Available only in East Coast Warehouse

W Available only in West Coast Warehouse

DRS Rails and Accessories

Choose top or bottom rail and rail height from the four options:

1/2" Glass

Ref. #	Warehouse	Product	Top/Bottom	U/M	Height	Locking	Style	Finish	List \$
234.011.101.SS	E	DRS Rail	Top	Ea.	2-1/2"	No	SQ	101	352
234.011.108.SS	E	DRS Rail	Top	Ea.	2-1/2"	No	SQ	108	367
234.011.700.SS	E	DRS Rail	Top	Ea.	2-1/2"	No	SQ	700	433
225.001.101.SS	E	DRS Rail	Top	Ea.	3-5/8"	No	SQ	101	225
225.001.700.SS	E	DRS Rail	Top	Ea.	3-5/8"	No	SQ	700	348
225.401.101.SS	E	DRS Rail	Top	Ea.	4"	No	SQ	101	225
225.401.700.SS	E	DRS Rail	Top	Ea.	4"	No	SQ	700	348
234.037.101.SS	E	DRS Rail	Bottom	Ea.	2-1/2"	No	SQ	101	339
234.037.108.SS	E	DRS Rail	Bottom	Ea.	2-1/2"	No	SQ	108	354
234.037.700.SS	E	DRS Rail	Bottom	Ea.	2-1/2"	No	SQ	700	420
234.017.101.SS	E	DRS Rail	Bottom	Ea.	2-1/2"	Yes	SQ	101	378
234.017.108.SS	E	DRS Rail	Bottom	Ea.	2-1/2"	Yes	SQ	108	393
234.017.700.SS	E	DRS Rail	Bottom	Ea.	2-1/2"	Yes	SQ	700	459
225.006.101.SS	E	DRS Rail	Bottom	Ea.	3-5/8"	No	SQ	101	212
225.006.700.SS	E	DRS Rail	Bottom	Ea.	3-5/8"	No	SQ	700	335
225.005.101.SS	E	DRS Rail	Bottom	Ea.	3-5/8"	Yes	SQ	101	251
225.005.700.SS	E	DRS Rail	Bottom	Ea.	3-5/8"	Yes	SQ	700	374
225.406.101.SS	E	DRS Rail	Bottom	Ea.	4"	No	SQ	101	212
225.406.700.SS	E	DRS Rail	Bottom	Ea.	4"	No	SQ	700	335
225.405.101.SS	E	DRS Rail	Bottom	Ea.	4"	Yes	SQ	101	251
225.405.700.SS	E	DRS Rail	Bottom	Ea.	4"	Yes	SQ	700	374

NOTE: Top rails include 8836 arm. Bottom rails include 8852 pivot. See page 3 for details.

DRS Top Rails for Center Hung Doors
 Choose top or bottom rail and rail height from the four options:

Ref. #	Warehouse	Product	Top/Bottom	Locking	Height	Cover	Style	Glass	Finish	List \$
33900146	☒	DRS Cover	—	No	2-1/2"	COV	SQ	3/8"-9/16" (10-14)	101	58
33900147	☒	DRS Cover	—	No	2-1/2"	COV	SQ	3/8"-9/16" (10-14)	108	84
33900148	☒	DRS Cover	—	No	2-1/2"	COV	SQ	3/8"-9/16" (10-14)	700	148
33900149	☒	DRS Cover	Bottom	Yes	2-1/2"	COV	SQ	3/8"-9/16" (10-14)	101	63
33900150	☒	DRS Cover	Bottom	Yes	2-1/2"	COV	SQ	3/8"-9/16" (10-14)	108	92
33900151	☒	DRS Cover	Bottom	Yes	2-1/2"	COV	SQ	3/8"-9/16" (10-14)	700	163
33900012	☒	DRS Cover	—	—	3-5/8"	COV	SQ	1/2" (12)	101	45
33900014	☒	DRS Cover	—	—	3-5/8"	COV	SQ	1/2" (12)	108	71
33900013	☒	DRS Cover	—	—	3-5/8"	COV	SQ	1/2" (12)	700	122
33900010	☒	DRS Cover	—	—	4"	COV	SQ	1/2" (12)	101	45
33900011	☒	DRS Cover	—	—	4"	COV	SQ	1/2" (12)	700	122
33900152	☒	DRS End Cap	—	—	2-1/2"	End Cap	SQ	1/2" (12)	101	34
33900153	☒	DRS End Cap	—	—	2-1/2"	End Cap	SQ	1/2" (12)	109	34
33900154	☒	DRS End Cap	—	—	2-1/2"	End Cap	SQ	1/2" (12)	619	68
33900015	☒	DRS End Cap	—	—	3-5/8"	End Cap	SQ	—	101	26
33900017	☒	DRS End Cap	—	—	3-5/8"	End Cap	SQ	—	109	26
33900016	☒	DRS End Cap	—	—	3-5/8"	End Cap	SQ	—	619	56
33900018	☒	DRS End Cap	—	—	4"	End Cap	SQ	—	101	26
33900019	☒	DRS End Cap	—	—	4"	End Cap	SQ	—	619	56

NOTES

- 109 finish end caps are used for 108 or 109 finish rails.
- End cap prices shown are for set of two.
- **619** finish end caps are used for 700 finish rails.

Ref. #	Warehouse	Product	Description	Finish	List \$
225.999.108.SS	☒	CYL	Mortise cylinder for DRS lock, with split ring	108	21
225.999.500.SS	☒	CYL	Mortise cylinder for DRS lock, with split ring	500	21
225.998.108.SS	☒	TT	Mortise thumb-turn for DRS lock, with split ring	108	21
225.998.500.SS	☒	TT	Mortise thumb-turn for DRS lock, with split ring	500	21
225.994.108.SS	☒	DUMY	Mortise dummy (blank) cylinder for DRS lock, split ring	108	15
225.994.500.SS	☒	DUMY	Mortise dummy (blank) cylinder for DRS lock, with split ring	500	15

DRS Top Rails Consist of:

Qty	U/M	HDW
1	Ea.	8836 Arm
1	Ea.	Top Rail
1	Set	Covers
1	Set	End Caps

DRS Bottom Rails Consist of:

1	Ea.	8852 Pivot
1	Ea.	Bottom Rail
1	Set	Covers
1	Set	End Caps
1 (Locking)	Ea.	Brass Lock

DRS Bottom Rails Consist of:

1	Ea.	8852 Pivot
1	Ea.	Bottom Rail
1	Set	Covers
1 (Non-Locking)	Set	End Caps

DRS Rails, Channels & Accessories

Patch Fittings & Designer Pivots

Offset Hung Patch Fittings

Headers & Accessories

Closers & Hardware

Locksets

Pulls & Handles

Sliding Systems

MANET

Panic Hardware

DRS Rails

Ordering Guide

Bottom Rail

10L	— 10" Bottom Rail w/ Lock
6L	— 6" Bottom Rail w/ Lock
4L	— 4" Bottom Rail w/ Lock
358L	— 3-5/8" Bottom Rail w/ Lock
25L	— 2-1/2" Bottom Rail w/ Lock
10	— 10" Bottom Rail
6	— 6" Bottom Rail
4	— 4" Bottom Rail
358	— 3-5/8" Bottom Rail
25	— 2-1/2" Bottom Rail

Top Rail Hardware

8836	— RTS End Load Arm
355.0	— Top Rail Insert (15 mm pin)
355.9	— Top Rail, Side Load, Adjustable Insert (Not Available w/ 2-1/2" Rail)
NONE	— None

Less Covers

Ordered Less Covers or Cladding

Model
DRS
NO

Rail Location

Top & Bottom — TOPBTM
Bottom — BTM
Top — TOP

DRS	EC2	TOP	358	STK	SQ	8836	8852	continued below
------------	------------	------------	------------	------------	-----------	-------------	-------------	-----------------

End Cap for Rail (1 each) — EC1	2-1/2" Top Rail — 25	Stock Length — 35-3/4" (907) — STK	Square Rail — SQ	8852	— Bottom Rail Arm for 8852 Floor Pivot
End Cap for Rail (2 each) — EC2	3-5/8" Top Rail — 358	Custom Length — SPECIFY	Tapered Rail ¹ — TP	355.1	— Bottom Rail Insert for BTS (Not Available w/ 2-1/2" Rail)
No End Cap for Rail — NONE	4" Top Rail — 4	Rail Length	Top Rail Profile	7422	— BTM Rail Arm for BTS/7471K
	6" Top Rail — 6			NONE	— None
	10" Top Rail — 10				

End Cap

Top Rail

Bottom Rail Hardware

Glass Thickness

9/16	— 9/16" (14) Tempered Laminated Glass
11/16	— 11/16" (17) Tempered Laminated Glass
13/16	— 13/16" (20) Tempered Laminated Glass
1/2	— 1/2" (12) Glass
3/8	— 3/8" (10) Glass
5/8	— 5/8" (16) Glass ²
3/4	— 3/4" (19) Glass ²

Bottom Rail Lock

NONE	— None
PANIC	— DG1000/DG1300 Prep
BRASSLK125	— Brass Lock for 2-1/2" Rail
BRASSLK178	— Brass Lock
BRASSLK1916	— Brass Lock

Vertical Stiles

VERTPACK	— Vertical Stiles
NONE	— None

Custom Preps

HDWPREP	— Custom Prep/Install of DORMA Hardware
CMP HDWP	— Competitor Hardware Prep
CMP HDW1	— Competitor Hardware Prep/Install
CMP SHEAR	— Competitor Electromagnetic Shear Lock or Magnetic Lock Armature Prep
NO	

1/2	NONE	NONE	NONE	101	NONE	NO
------------	-------------	-------------	-------------	------------	-------------	-----------

Magnetic Shear Lock — 2765	Thumb Turn x Thumb Turn — TTXTT	101	— Clear Anodized (CL)
DG1000/DG1300 Prep — PANIC	Thumb Turn x Dummy — TTXDUMY	108	— Dark Bronze (DB)
None — NONE	Cylinder x Thumb Turn — CYLXTT	109	— Black Anodized (BK)
Top Rail Lock	Cylinder x Dummy — CYLXDUMY	503	— Polished Brass w/o Lacquer (PB)
	None — NONE	599	— Satin Brass w/o Lacquer (SB)
		600	— Satin Bronze w/o Lacquer (SBZ)
		601	— Polished Bronze w/o Lacquer (PB2)
		700	— Satin Stainless Steel (SS/US32D)
		701	— Polished Stainless Steel (PS/US32)

Cylinder for Brass Lock

Standard Finish

199	— Special Anodized (Specify)
299	— Special Cladding (Specify)
399	— Special Paint or Powder Coat (Specify)

Finish Custom^{3,4}

1 Tapered Rail (TP) available only with 2-1/2", 3-5/8", and 4" rails.
 2 5/8" (16) and 3/4" (19) glass (Not available with 4" high rail).
 3 dormakaba reserves the right to refuse Custom Finishes.
 4 All Custom Finishes require customer sign-off/approval of color chip.

Standard DRS Rails (35-3/4")

35-3/4" Stock Rails									
Ref #	Rail Height	HDW	Profile	U/M	TOP/BTM	NLCK/LCK	Glass Thickness	101 ³	700 ³
225.001	3-5/8"	8836	SQ	Ea.	TOP	—	1/2" (12)	221	341
225.021	3-5/8"	8836	TP	Ea.	TOP	—	1/2" (12)	221	341
225.401	4"	8836	SQ	Ea.	TOP	—	1/2" (12)	221	341
225.421	4"	8836	TP	Ea.	TOP	—	1/2" (12)	221	341
225.003	3-5/8"	355.0	SQ	Ea.	TOP	—	1/2" (12)	192	313
225.023	3-5/8"	355.0	TP	Ea.	TOP	—	1/2" (12)	192	313
225.403	4"	355.0	SQ	Ea.	TOP	—	1/2" (12)	192	313
225.423	4"	355.0	TP	Ea.	TOP	—	1/2" (12)	192	313
225.006	3-5/8"	8852	SQ	Ea.	BTM	NLCK	1/2" (12)	208	328
225.026	3-5/8"	8852	TP	Ea.	BTM	NLCK	1/2" (12)	208	328
225.406	4"	8852	SQ	Ea.	BTM	NLCK	1/2" (12)	208	328
225.426	4"	8852	TP	Ea.	BTM	NLCK	1/2" (12)	208	328
225.010	3-5/8"	7422	SQ	Ea.	BTM	NLCK	1/2" (12)	223	344
225.030	3-5/8"	7422	TP	Ea.	BTM	NLCK	1/2" (12)	223	344
225.410	4"	7422	SQ	Ea.	BTM	NLCK	1/2" (12)	223	344
225.430	4"	7422	TP	Ea.	BTM	NLCK	1/2" (12)	223	344
225.005	3-5/8"	8852	SQ	Ea.	BTM	LCK	1/2" (12)	246	367
225.025	3-5/8"	8852	TP	Ea.	BTM	LCK	1/2" (12)	246	367
225.405	4"	8852	SQ	Ea.	BTM	LCK	1/2" (12)	246	367
225.425	4"	8852	TP	Ea.	BTM	LCK	1/2" (12)	246	367
225.009	3-5/8"	7422	SQ	Ea.	BTM	LCK	1/2" (12)	262	382
225.029	3-5/8"	7422	TP	Ea.	BTM	LCK	1/2" (12)	262	382
225.418	4"	7422	SQ	Ea.	BTM	LCK	1/2" (12)	262	382
225.429	4"	7422	TP	Ea.	BTM	LCK	1/2" (12)	262	382

³ Standard or Non-Standard Fabricated; lead time up to 3 business days.

- DRS Rails, Channels & Accessories
- Patch Fittings & Designer Pivots
- Offset Hung Patch Fittings
- Headers & Accessories
- Closers & Hardware
- Locksets
- Pulls & Handles
- Sliding Systems
- MANET
- Panic Hardware

DRS Top Rails, Type P, Finished Door Size 24" (610) to 48" (1219)

Default 1/2" (12) unless otherwise specified

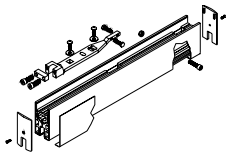

Square (SQ) DRS Top Rail –
8836 (928.006) Arm

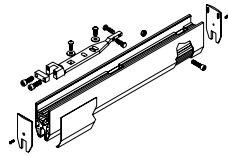

Tapered (TP) DRS Top Rail –
8836 (928.006) Arm

Select Service DRS Top Rail Square (SQ) with 8836 (928.006) Arm				101	108	700
Profile	Ref. #	U/M	Glass Thickness	①	①	①
(25) 2-1/2" Rail Height						
SQ	234.011.SS	Ea.	1/2" (12)	352	367	433
(358) 3-5/8" Rail Height						
SQ	225.001.SS	Ea.	1/2" (12)	225	—	348

				Standard Finishes \$				Custom Finishes \$		
DRS Top Rail Square (SQ) or Tapered (TP) with 8836 (928.006) Arm				101	108/109	503/599	600/601	700/701	199/399	299
Profile	Ref. #	U/M	Glass Thickness	③	③	⑤0	⑤0	③	⑥	⑥
(25) 2-1/2" Rail Height										
SQ	234.061	Ea.	3/8" (10)	352	367	529	616	433	627	713
SQ	234.011	Ea.	1/2" (12)	352	367	529	616	433	627	713
SQ	234.091	Ea.	5/8" (16)	393	407	591	688	484	700	799
SQ	234.204	Ea.	3/4" (19)	393	407	591	688	484	700	799
SQ	234.122	Ea.	9/16" (14)	440	455	617	704	521	715	801
SQ	234.125	Ea.	11/16" (17)	481	495	679	776	572	788	887
SQ	234.300	Ea.	13/16" (20)	481	495	679	776	572	788	887
TP	234.064	Ea.	3/8" (10)	352	367	529	616	433	627	713
TP	234.014	Ea.	1/2" (12)	352	367	529	616	433	627	713
TP	234.116	Ea.	5/8" (16)	393	407	591	688	484	700	799
TP	234.119	Ea.	3/4" (19)	393	407	591	688	484	700	799
TP	234.128	Ea.	9/16" (14)	440	455	617	704	521	715	801
TP	234.131	Ea.	11/16" (17)	481	495	679	776	572	788	887
TP	234.307	Ea.	13/16" (20)	481	495	679	776	572	788	887
(358) 3-5/8" Rail Height										
SQ	225.040	Ea.	3/8" (10)	225	254	445	516	348	489	588
SQ	225.001	Ea.	1/2" (12)	225	254	445	516	348	489	588
SQ	225.002	Ea.	5/8" (16)	251	278	470	541	366	515	614
SQ	225.051	Ea.	3/4" (19)	251	278	470	541	366	515	614
SQ	225.011	Ea.	9/16" (14)	313	342	533	604	436	577	676
SQ	225.012	Ea.	11/16" (17)	339	366	558	629	454	603	702
SQ	225.300	Ea.	13/16" (20)	339	366	558	629	454	603	702
TP	225.043	Ea.	3/8" (10)	225	254	445	516	348	489	588
TP	225.021	Ea.	1/2" (12)	225	254	445	516	348	489	588
TP	225.196	Ea.	9/16" (14)	313	342	533	604	436	577	676

DRS Top Rails, Type P, Finished Door Size 24" (610) to 48" (1219)

Default 1/2" (12) unless otherwise specified

Select Service DRS Top Rail Square (SQ) with 8836 (928.006) Arm					101	700
Profile	Ref. #	U/M	Glass Thickness	①	①	
(4) 4" Rail Height						
SQ	225.401.SS	Ea.	1/2" (12)	225	348	

				Standard Finishes \$				Custom Finishes \$		
DRS Top Rail Square (SQ) or Tapered (TP) with 8836 (928.006) Arm				101	108/109	503/599	600/601	700/701	199/399	299
Profile	Ref. #	U/M	Glass Thickness	③	③	SO	SO	③	Q	Q
(4) 4" Rail Height										
SQ	225.442	Ea.	3/8" (10)	225	254	445	516	348	489	588
SQ	225.401	Ea.	1/2" (12)	225	254	445	516	348	489	588
SQ	225.013	Ea.	9/16" (14)	313	342	533	604	436	577	676
TP	225.443	Ea.	3/8" (10)	225	254	445	516	348	489	588
TP	225.421	Ea.	1/2" (12)	225	254	445	516	348	489	588
TP	225.198	Ea.	9/16" (14)	313	342	533	604	436	577	676
(6) 6" Rail Height										
SQ	225.140	Ea.	3/8" (10)	464	483	698	713	518	724	827
SQ	225.111	Ea.	1/2" (12)	464	483	698	713	518	724	827
SQ	225.150	Ea.	5/8" (16)	490	509	725	739	547	750	853
SQ	225.161	Ea.	3/4" (19)	490	509	725	739	547	750	853
SQ	225.015	Ea.	9/16" (14)	552	571	786	801	606	812	915
SQ	225.016	Ea.	11/16" (17)	578	597	813	827	635	838	941
SQ	225.360	Ea.	13/16" (20)	578	597	813	827	635	838	941
(10) 10" Rail Height										
SQ	225.340	Ea.	3/8" (10)	682	695	966	1,028	821	970	1,070
SQ	225.311	Ea.	1/2" (12)	682	695	966	1,028	821	970	1,070
SQ	225.019	Ea.	5/8" (16)	765	778 SO	1,080	1,149	921	1,086	1,198
SQ	225.031	Ea.	3/4" (19)	765	778 SO	1,080	1,149	921	1,086	1,198
SQ	225.017	Ea.	9/16" (14)	770	783	1,054	1,116	909	1,058	1,158
SQ	225.018	Ea.	11/16" (17)	853	866	1,168	1,237	1,009	1,174	1,286

- Laminated**
- ① Non-Fabricated item, ships in 1 business day.
 - ③ Standard or Non-Standard Fabricated; lead time up to 3 business days.
 - SO Special Fabricated/Finish or Special Order; lead time up to 5 weeks.

NOTES:

- Laminated options include 1 ea. tube of adhesive (934.800) and 4 ea. mixing tips (934.805) up to 52" rail.
- Applicator gun sold separately (934.801)
- Specify overall rail size and finish when ordering.
- Rails exceeding 48" (1219) will add a list charge per 12" (305), rounding up to the next full foot dimension (i.e. 60" between 48" and 52").
- Shear Locks can be ordered complete with Headers or can be ordered as a separate sales order line item.
- Base Price Includes Rail, Rail Covers/Cladding where appropriate, End Caps and Installed Hardware.
- All 108 finish DRS Rails will be provided with black (109) end caps.
- Reference Options and Prep Charges at the end of rail section.

DRS Rails, Channels & Accessories
 Patch Fittings & Designer Pivots
 Offset Hung Patch Fittings
 Headers & Accessories
 Closers & Hardware
 Locksets
 Pulls & Handles
 Sliding Systems
 MANET
 Panic Hardware

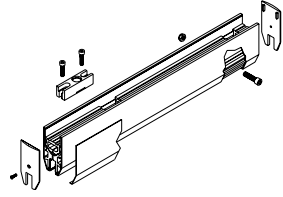
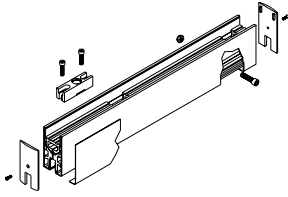

Square (SQ) DRS Top Rail —
355.0 (904.610) Insert

Tapered (TP) DRS Top Rail —
355.0 (904.610) Insert

				Standard Finishes \$				Custom Finishes \$		
DRS Top Rail Square (SQ) or Tapered (TP) with 355.0 (904.610) Insert				101	108/109	503/599	600/601	700/701	199/399	299
Profile	Ref. #	U/M	Glass Thickness	3	3	SO	SO	3	Q	Q
(25) 2-1/2" Rail Height										
SQ	234.062	Ea.	3/8" (10)	323	338	500	587	404	598	684
SQ	234.012	Ea.	1/2" (12)	323	338	500	587	404	598	684
SQ	234.092	Ea.	5/8" (16)	364	378	562	659	455	671	770
SQ	234.205	Ea.	3/4" (19)	364	378	562	659	455	671	770
SQ	234.123	Ea.	9/16" (14)	411	426	588	675	492	686	772
SQ	234.126	Ea.	11/16" (17)	452	466	650	747	543	759	858
SQ	234.301	Ea.	13/16" (20)	452	466	650	747	543	759	858
TP	234.065	Ea.	3/8" (10)	323	338	500	587	404	598	684
TP	234.015	Ea.	1/2" (12)	323	338	500	587	404	598	684
TP	234.117	Ea.	5/8" (16)	364	378	562	659	455	671	770
TP	234.120	Ea.	3/4" (19)	364	378	562	659	455	671	770
TP	234.129	Ea.	9/16" (14)	411	426	588	675	492	686	772
TP	234.132	Ea.	11/16" (17)	452	466	650	747	543	759	858
TP	234.308	Ea.	13/16" (20)	452	466	650	747	543	759	858
(358) 3-5/8" Rail Height										
SQ	225.041	Ea.	3/8" (10)	196	225	416	487	319	460	559
SQ	225.003	Ea.	1/2" (12)	196	225	416	487	319	460	559
SQ	225.020	Ea.	5/8" (16)	222	249	441	512	337	486	585
SQ	225.053	Ea.	3/4" (19)	222	249	441	512	337	486	585
SQ	225.032	Ea.	9/16" (14)	284	313	504	575	407	548	647
SQ	225.033	Ea.	11/16" (17)	310	337	529	600	425	574	673
SQ	225.301	Ea.	13/16" (20)	310	337	529	600	425	574	673
TP	225.044	Ea.	3/8" (10)	196	225	416	487	319	460	559
TP	225.023	Ea.	1/2" (12)	196	225	416	487	319	460	559
TP	225.216	Ea.	9/16" (14)	284	313	504	575	407	548	647

DRS Top Rails, Type P, Finished Door Size 24" (610) to 48" (1219)

Default 1/2" (12) unless otherwise specified

				Standard Finishes \$					Custom Finishes \$	
DRS Top Rail Square (SQ) or Tapered (TP) with 355.0 (904.610) Insert				101	108/109	503/599	600/601	700/701	199/399	299
Profile	Ref. #	U/M	Glass Thickness	③	③	⑤①	⑤①	③	①	①
(4) 4" Rail Height										
SQ	225.409	Ea.	3/8" (10)	196	225	416	487	319	460	559
SQ	225.403	Ea.	1/2" (12)	196	225	416	487	319	460	559
SQ	225.034	Ea.	9/16" (14)	284	313	504	575	407	548	647
TP	225.444	Ea.	3/8" (10)	196	225	416	487	319	460	559
TP	225.423	Ea.	1/2" (12)	196	225	416	487	319	460	559
TP	225.218	Ea.	9/16" (14)	284	313	504	575	407	548	647
(6) 6" Rail Height										
SQ	225.141	Ea.	3/8" (10)	435	454	669	684	489	695	798
SQ	225.113	Ea.	1/2" (12)	435	454	669	684	489	695	798
SQ	225.151	Ea.	5/8" (16)	461	480	696	710	518	721	824
SQ	225.163	Ea.	3/4" (19)	461	480	696	710	518	721	824
SQ	225.036	Ea.	9/16" (14)	523	542	757	772	577	783	886
SQ	225.037	Ea.	11/16" (17)	549	568	784	798	606	809	912
SQ	225.361	Ea.	13/16" (20)	549	568	784	798	606	809	912
(10) 10" Rail Height										
SQ	225.341	Ea.	3/8" (10)	653	667	937	999	792	941	1,041
SQ	225.313	Ea.	1/2" (12)	653	667	937	999	792	941	1,041
SQ	225.046	Ea.	5/8" (16)	736	749 ^{⑤①}	1,051	1,120	892	1,057	1,169
SQ	225.052	Ea.	3/4" (19)	736	749 ^{⑤①}	1,051	1,120	892	1,057	1,169
SQ	225.038	Ea.	9/16" (14)	741	754	1,025	1,087	880	1,029	1,129
SQ	225.039	Ea.	11/16" (17)	824	837	1,139	1,208	980	1,145	1,257

Laminated

- ③ Standard or Non-Standard Fabricated; lead time up to 3 business days.
- ⑤① Special Fabricated/Finish or Special Order; lead time up to 5 weeks.

NOTES:

- Laminated options include 1 ea. tube of adhesive (934.800) and 4 ea. mixing tips (934.805) up to 52" rail.
- Applicator gun sold separately (934.801)
- Specify overall rail size and finish when ordering.
- Rails exceeding 48" (1219) will add a list charge per 12" (305), rounding up the next full foot dimension (i.e. between 48" - 52").
- Shear Locks can be ordered complete with Headers or can be ordered as a separate sales order line item.
- Base Price Includes Rail, Rail Covers/Cladding where appropriate, End Caps and Installed Hardware.
- All 108 finish DRS Rails will be provided with black (109) end caps.
- Reference Options and Prep Charges at the end of rail section.

DRS Rails, Channels & Accessories
Patch Fittings & Designer Pivots
Offset Hung Patch Fittings
Headers & Accessories
Closers & Hardware
Locksets
Pulls & Handles
Sliding Systems
MANET
Panic Hardware

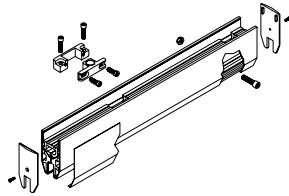
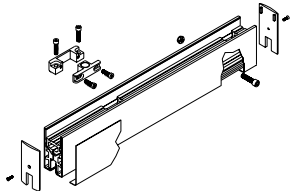

Square (SQ) DRS Top Rail –
355.9 (904.091) Pivot Insert

Tapered (TP) DRS Top Rail –
355.9 (904.091) Pivot Insert

Standard Finishes \$

Custom Finishes \$

DRS Top Rail Square (SQ) or Tapered (TP)
with 355.9 (904.091) Pivot Insert

Profile	Ref. #	U/M	Glass Thickness	Standard Finishes \$				Custom Finishes \$		
				101	108/109	503/599	600/601	700/701	199/399	299
				3	3	SO	SO	3	Q	Q
(25) 2-1/2" Rail Height										
SQ	234.063	Ea.	3/8" (10)	351	366	528	615	432	626	712
SQ	234.013	Ea.	1/2" (12)	351	366	528	615	432	626	712
SQ	234.094	Ea.	5/8" (16)	392	406	590	687	483	699	798
SQ	234.206	Ea.	3/4" (19)	392	406	590	687	483	699	798
SQ	234.287	Ea.	9/16" (14)	439	454	616	703	520	714	800
SQ	234.288	Ea.	11/16" (17)	480	494	678	775	571	787	886
SQ	234.289	Ea.	13/16" (20)	480	494	678	775	571	787	886
TP	234.066	Ea.	3/8" (10)	351	366	528	615	432	626	712
TP	234.016	Ea.	1/2" (12)	351	366	528	615	432	626	712
TP	234.118	Ea.	5/8" (16)	392	406	590	687	483	699	798
TP	234.121	Ea.	3/4" (19)	392	406	590	687	483	699	798
TP	234.130	Ea.	9/16" (14)	439	454	616	703	520	714	800
TP	234.133	Ea.	11/16" (17)	480	494	678	775	571	787	886
TP	234.140	Ea.	13/16" (20)	480	494	678	775	571	787	886
(358) 3-5/8" Rail Height										
SQ	225.042	Ea.	3/8" (10)	224	253	444	515	347	488	587
SQ	225.004	Ea.	1/2" (12)	224	253	444	515	347	488	587
SQ	225.022	Ea.	5/8" (16)	250	277	469	540	365	514	613
SQ	225.054	Ea.	3/4" (19)	250	277	469	540	365	514	613
SQ	225.186	Ea.	9/16" (14)	312	341	532	603	435	576	675
SQ	225.187	Ea.	11/16" (17)	338	365	557	628	453	602	701
SQ	225.302	Ea.	13/16" (20)	338	365	557	628	453	602	701
TP	225.045	Ea.	3/8" (10)	224	253	444	515	347	488	587
TP	225.024	Ea.	1/2" (12)	224	253	444	515	347	488	587
TP	225.220	Ea.	9/16" (14)	312	341	532	603	435	576	675
(4) 4" Rail Height										
SQ	225.417	Ea.	3/8" (10)	224	253	444	515	347	488	587
SQ	225.404	Ea.	1/2" (12)	224	253	444	515	347	488	587
SQ	225.188	Ea.	9/16" (14)	312	341	532	603	435	576	675
TP	225.445	Ea.	3/8" (10)	224	253	444	515	347	488	587
TP	225.424	Ea.	1/2" (12)	224	253	444	515	347	488	587
TP	225.222	Ea.	9/16" (14)	312	341	532	603	435	576	675

DRS Top Rails, Type P, Finished Door Size 24" (610) to 48" (1219)

Default 1/2" (12) unless otherwise specified

				Standard Finishes \$				Custom Finishes \$		
DRS Top Rail Square (SQ) or Tapered (TP) with 355.9 (904.091) Pivot Insert				101	108/109	503/599	600/601	700/701	199/399	299
Profile	Ref. #	U/M	Glass Thickness	3	3	SO	SO	3	Q	Q
(6) 6" Rail Height										
SQ	225.142	Ea.	3/8" (10)	463	482	697	712	517	723	826
SQ	225.114	Ea.	1/2" (12)	463	482	697	712	517	723	826
SQ	225.152	Ea.	5/8" (16)	489	508	724	738	546	749	852
SQ	225.164	Ea.	3/4" (19)	489	508	724	738	546	749	852
SQ	225.190	Ea.	9/16" (14)	551	570	785	800	605	811	914
SQ	225.191	Ea.	11/16" (17)	577	596	812	826	634	837	940
SQ	225.362	Ea.	13/16" (20)	577	596	812	826	634	837	940
(10) 10" Rail Height										
SQ	225.342	Ea.	3/8" (10)	681	694	965	1,027	820	969	1,069
SQ	225.314	Ea.	1/2" (12)	681	694	965	1,027	820	969	1,069
SQ	225.194	Ea.	5/8" (16)	764	777 SO	1,079	1,148	920	1,085	1,197
SQ	225.195	Ea.	3/4" (19)	764	777 SO	1,079	1,148	920	1,085	1,197
SQ	225.192	Ea.	9/16" (14)	769	782	1,053	1,115	908	1,057	1,157
SQ	225.193	Ea.	11/16" (17)	852	865	1,167	1,236	1,008	1,173	1,285

Laminated

3 Standard or Non-Standard Fabricated; lead time up to 3 business days.
 SO Special Fabricated/Finish or Special Order; lead time up to 5 weeks.

NOTES:

- Laminated options include 1 ea. tube of adhesive (934.800) and 4 ea. mixing tips (934.805) up to 52" rail.
- Applicator gun sold separately (934.801)
- Specify overall rail size and finish when ordering.
- Rails exceeding 48" (1219) will add a list charge per 12" (305), rounding up the next full foot dimension (i.e. between 48"- 52").
- Shear Locks can be ordered complete with Headers or can be ordered as a separate sales order line item.
- Base Price Includes Rail, Rail Covers/Cladding where appropriate, End Caps and Installed Hardware.
- All 108 finish DRS Rails will be provided with black (109) end caps.
- Reference Options and Prep Charges at the end of rail section.

Accessories

Model	U/M	Ref. #	Description	List \$
8836	Ea.	928.006	7/8" End Load Top Arm, RTS	58
355.0	Ea.	904.610	Top Rail Insert for 15 mm Pin	29
355.9	Ea.	904.091	Top Rail Adjustable Insert	58
LGAA	Ea.	934.801	3M™ Scotch-Weld™ EPX™ plus II applicator with 2:1 and 1:1 plunger	330
LGA	Ea.	934.800	3M™ Scotch-Weld™ Urethane Adhesive, DP 605 NS, off white, 1 tube per 52" of pre-assembled rail	78
MTIPS	Set	934.805	3M™ Scotch-Weld™ EPX™ plus II mixing square nozzle, 5.3 mm (4 tips pers set)	10
				List Add \$
PANIC			Prep for Glass Panic/Deadbolt Push Bar Device in rail	80
ELCK PREP			dormakaba EMSL Shearlock, or EML Magnetic Lock armature preparation and installation in DRS rail	175
HDWPREP			Prep and Install of non-standard dormakaba hardware (i.e., offset pivots, arms, etc.) in DRS rail	80
CMP HDWP			Competitors hardware only prep. in DRS rail (charge may be reviewed based on complexity)	95
CMP HDWI			Competitors hardware preparation and installation in DRS rails	160
CMP SHEAR			Competitors Electro-Magnetic Shear Lock or Magnetic Lock Armature Preparation only in DRS rails	300
MITER			Miter cut charge	65
				Net Add \$
POWDER			All Custom powder coated orders will include a net charge per purchase order.	200

NOTE: Scotch-Weld™ Urethane Adhesive, Scotch-Weld™ EPX™ plus II applicator, and Scotch-Weld™ EPX™ plus II mixing square nozzle are trademarks of 3M.

DRS Rails, Channels & Accessories
 Patch Fittings & Designer Pivots
 Offset Hung Patch Fittings
 Headers & Accessories
 Closers & Hardware
 Locksets
 Pulls & Handles
 Sliding Systems
 MANET
 Panic Hardware

DRS Bottom Rails, No Lock

Default 1/2" (12) unless otherwise specified

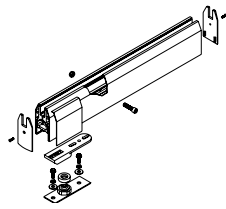
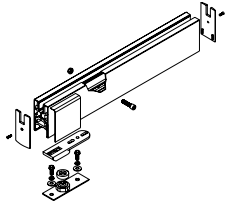

Square (SQ) DRS Bottom Rail
No Lock – 8852 (928.055) Pivot

Tapered (TP) DRS Bottom Rail
No Lock – 8852 (928.055) Pivot

Select Service DRS Bottom Rail Square (SQ) with 8852 (928.055) Pivot				101	108	700
Profile	Ref. #	U/M	Glass Thickness	①	①	①
(25) 2-1/2" Rail Height						
SQ	234.037.SS	Ea.	1/2" (12)	339	354	420
(358) 3-5/8" Rail Height						
SQ	225.006.SS	Ea.	1/2" (12)	212	—	335

				Standard Finishes \$				Custom Finishes \$		
DRS Bottom Rail Square (SQ) or Tapered (TP) with 8852 (928.055) Pivot				101	108/109	503/599	600/601	700/701	199/399	299
Profile	Ref. #	U/M	Glass Thickness	③	③	⑤0	⑤0	③	④	④
(25) 2-1/2" Rail Height										
SQ	234.073	Ea.	3/8" (10)	339	354	516	603	420	614	700
SQ	234.037	Ea.	1/2" (12)	339	354	516	603	420	614	700
SQ	234.219	Ea.	5/8" (16)	380	394	578	675	471	687	786
SQ	234.227	Ea.	3/4" (19)	380	394	578	675	471	687	786
SQ	234.174	Ea.	9/16" (14)	427	442	604	691	508	702	788
SQ	234.177	Ea.	11/16" (17)	468	482	667	763	559	775	874
SQ	234.302	Ea.	13/16" (20)	468	482	667	763	559	775	874
TP	234.076	Ea.	3/8" (10)	339	354	516	603	420	614	700
TP	234.032	Ea.	1/2" (12)	339	354	516	603	420	614	700
TP	234.168	Ea.	5/8" (16)	380	394	578	675	471	687	786
TP	234.171	Ea.	3/4" (19)	380	394	578	675	471	687	786
TP	234.180	Ea.	9/16" (14)	427	442	604	691	508	702	788
TP	234.183	Ea.	11/16" (17)	468	482	667	763	559	775	874
TP	234.309	Ea.	13/16" (20)	468	482	667	763	559	775	874
(358) 3-5/8" Rail Height										
SQ	225.085	Ea.	3/8" (10)	212	241	432	503	335	476	575
SQ	225.006	Ea.	1/2" (12)	212	241	432	503	335	476	575
SQ	225.213	Ea.	5/8" (16)	238	265	457	528	353	502	601
SQ	225.056	Ea.	3/4" (19)	238	265	457	528	353	502	601
SQ	225.061	Ea.	9/16" (14)	300	329	520	591	423	564	663
SQ	225.062	Ea.	11/16" (17)	326	353	545	616	441	590	689
SQ	225.303	Ea.	13/16" (20)	326	353	545	616	441	590	689
TP	225.088	Ea.	3/8" (10)	212	241	432	503	335	476	575
TP	225.026	Ea.	1/2" (12)	212	241	432	503	335	476	575
TP	225.226	Ea.	9/16" (14)	300	329	520	591	423	564	663

DRS Bottom Rails, No Lock

Default 1/2" (12) unless otherwise specified

Select Service DRS Bottom Rail Square (SQ) with 8852 (928.055) Pivot					101	700
Profile	Ref. #	U/M	Glass Thickness	①	①	
(4) 4" Rail Height						
SQ	225.406.SS	Ea.	1/2" (12)	212	335	

DRS Bottom Rail Square (SQ) or Tapered (TP) with 8852 (928.055) Pivot	Standard Finishes \$					Custom Finishes \$	
	101	108/109	503/599	600/601	700/701	199/399	299

Profile	Ref. #	U/M	Glass Thickness	③	③	⑤0	⑤0	③	④	④
(4) 4" Rail Height										
SQ	225.414	Ea.	3/8" (10)	212	241	432	503	335	476	575
SQ	225.406	Ea.	1/2" (12)	212	241	432	503	335	476	575
SQ	225.063	Ea.	9/16" (14)	300	329	520	591	423	564	663
TP	225.438	Ea.	3/8" (10)	212	241	432	503	335	476	575
TP	225.426	Ea.	1/2" (12)	212	241	432	503	335	476	575
TP	225.228	Ea.	9/16" (14)	300	329	520	591	423	564	663
(6) 6" Rail Height										
SQ	225.147	Ea.	3/8" (10)	451	470	685	700	505	711	814
SQ	225.106	Ea.	1/2" (12)	451	470	685	700	505	711	814
SQ	225.154	Ea.	5/8" (16)	477	496	712	726	534	737	840
SQ	225.156	Ea.	3/4" (19)	477	496	712	726	534	737	840
SQ	225.065	Ea.	9/16" (14)	539	558	773	788	593	799	902
SQ	225.066	Ea.	11/16" (17)	565	584	800	814	622	825	928
SQ	225.363	Ea.	13/16" (20)	565	584	800	814	622	825	928
(10) 10" Rail Height										
SQ	225.344	Ea.	3/8" (10)	669	682	953	1,015	808	957	1,057
SQ	225.306	Ea.	1/2" (12)	669	682	953	1,015	808	957	1,057
SQ	225.069	Ea.	5/8" (16)	752	765 ^{⑤0}	1,067	1,136	908	1,073	1,185
SQ	225.070	Ea.	3/4" (19)	752	765 ^{⑤0}	1,067	1,136	908	1,073	1,185
SQ	225.067	Ea.	9/16" (14)	757	770	1,041	1,103	896	1,045	1,145
SQ	225.068	Ea.	11/16" (17)	840	853	1,155	1,224	996	1,161	1,273

- Laminated**
- ① Non-Fabricated item, ships in 1 business day.
 - ③ Standard or Non-Standard Fabricated; lead time up to 3 business days.
 - ⑤0 Special Fabricated/Finish or Special Order; lead time up to 5 weeks.

- NOTES:**
- Laminated options include 1 ea. tube of adhesive (934.800) and 4 ea. mixing tips (934.805) up to 52" rail.
 - Applicator gun sold separately (934.801)
 - Specify overall rail size and finish when ordering.
 - Rails exceeding 48" (1219) will add a list charge per 12" (305), rounding up the next full foot dimension (i.e. between 48" - 52").
 - Base Price Includes Rail, Rail Covers/Cladding where appropriate, End Caps and Installed Hardware.
 - All 108 finish DRS Rails will be provided with black (109) end caps.
 - Reference Options and Prep Charges at the end of rail section.

DRS Rails, Channels & Accessories
 Patch Fittings & Designer Pivots
 Offset Hung Patch Fittings
 Headers & Accessories
 Closers & Hardware
 Locksets
 Pulls & Handles
 Sliding Systems
 MANET
 Panic Hardware

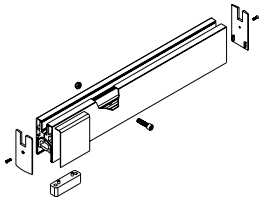

Square (SQ) DRS Bottom Rail
No Lock – 355.1 (904.020) Insert

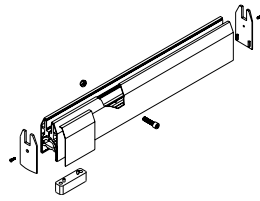

Tapered (TP) DRS Bottom Rail
No Lock – 355.1 (904.020) Insert

					Standard Finishes \$				Custom Finishes \$		
DRS Bottom Rail Square (SQ) or Tapered (TP) with 355.1 (904.020) Insert					101	108/109	503/599	600/601	700/701	199/399	299
Profile	Ref. #	U/M	Glass Thickness	3	3	SO	SO	3	Q	Q	
(358) 3-5/8" Rail Height											
SQ	225.086	Ea.	3/8" (10)	204	233	424	495	327	468	567	
SQ	225.008	Ea.	1/2" (12)	204	233	424	495	327	468	567	
SQ	225.214	Ea.	5/8" (16)	230	257	449	520	345	494	593	
SQ	225.058	Ea.	3/4" (19)	230	257	449	520	345	494	593	
SQ	225.071	Ea.	9/16" (14)	292	321	512	583	415	556	655	
SQ	225.072	Ea.	11/16" (17)	318	345	537	608	433	582	681	
SQ	225.304	Ea.	13/16" (20)	318	345	537	608	433	582	681	
TP	225.089	Ea.	3/8" (10)	204	233	424	495	327	468	567	
TP	225.028	Ea.	1/2" (12)	204	233	424	495	327	468	567	
TP	225.230	Ea.	9/16" (14)	292	321	512	583	415	556	655	
(4) 4" Rail Height											
SQ	225.415	Ea.	3/8" (10)	204	233	424	495	327	468	567	
SQ	225.408	Ea.	1/2" (12)	204	233	424	495	327	468	567	
SQ	225.073	Ea.	9/16" (14)	292	321	512	583	415	556	655	
TP	225.439	Ea.	3/8" (10)	204	233	424	495	327	468	567	
TP	225.428	Ea.	1/2" (12)	204	233	424	495	327	468	567	
TP	225.232	Ea.	9/16" (14)	292	321	512	583	415	556	655	
(6) 6" Rail Height											
SQ	225.148	Ea.	3/8" (10)	443	462	677	692	497	703	806	
SQ	225.108	Ea.	1/2" (12)	443	462	677	692	497	703	806	
SQ	225.165	Ea.	5/8" (16)	469	488	704	718	526	729	832	
SQ	225.158	Ea.	3/4" (19)	469	488	704	718	526	729	832	
SQ	225.075	Ea.	9/16" (14)	531	550	765	780	585	791	894	
SQ	225.076	Ea.	11/16" (17)	557	576	792	806	614	817	920	
SQ	225.364	Ea.	13/16" (20)	557	576	792	806	614	817	920	
(10) 10" Rail Height											
SQ	225.346	Ea.	3/8" (10)	661	674	945	1,007	800	949	1,049	
SQ	225.308	Ea.	1/2" (12)	661	674	945	1,007	800	949	1,049	
SQ	225.091	Ea.	5/8" (16)	744	757 ^{SO}	1,059	1,128	900	1,065	1,177	
SQ	225.092	Ea.	3/4" (19)	744	757 ^{SO}	1,059	1,128	900	1,065	1,177	
SQ	225.077	Ea.	9/16" (14)	749	762	1,033	1,095	888	1,037	1,137	
SQ	225.078	Ea.	11/16" (17)	832	845	1,147	1,216	988	1,153	1,265	

Laminated 3 Standard or Non-Standard Fabricated; lead time up to 3 business days.
SO Special Fabricated/Finish or Special Order; lead time up to 5 weeks.

NOTES:

- Laminated options include 1 ea. tube of adhesive (934.800) and 4 ea. mixing tips (934.805) up to 52" rail.
- Applicator gun sold separately (934.801)
- Specify overall rail size and finish when ordering.
- Rails exceeding 48" (1219) will add a list charge per 12" (305), rounding up the next full foot dimension (i.e. between 48" - 52").
- All 108 finish DRS Rails will be provided with black (109) end caps.
- Reference Options and Prep Charges at the end of rail section.

DRS Bottom Rails, No Lock

Default 1/2" (12) unless otherwise specified

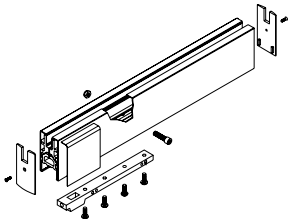

Square (SQ) DRS Bottom Rail
No Lock – 7422 (227.002) Arm

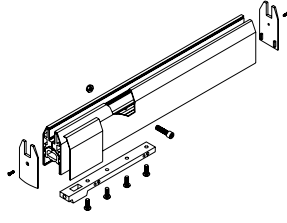

Tapered (TP) DRS Bottom Rail
No Lock – 7422 (227.002) Arm

				Standard Finishes \$					Custom Finishes \$	
DRS Bottom Rail Square (SQ) or Tapered (TP) with 7422 (227.002) Arm				101	108/109	503/599	600/601	700/701	199/399	299
Profile	Ref. #	U/M	Glass Thickness	3	3	SO	SO	3	Q	Q
(25) 2-1/2" Rail Height										
SQ	234.075	Ea.	3/8" (10)	355	370	532	619	436	630	716
SQ	234.039	Ea.	1/2" (12)	355	370	532	619	436	630	716
SQ	234.221	Ea.	5/8" (16)	396	410	594	691	487	703	802
SQ	234.229	Ea.	3/4" (19)	396	410	594	691	487	703	802
SQ	234.176	Ea.	9/16" (14)	443	458	620	707	524	718	804
SQ	234.179	Ea.	11/16" (17)	484	498	682	779	575	791	890
SQ	234.303	Ea.	13/16" (20)	484	498	682	779	575	791	890
TP	234.078	Ea.	3/8" (10)	355	370	532	619	436	630	716
TP	234.036	Ea.	1/2" (12)	355	370	532	619	436	630	716
TP	234.170	Ea.	5/8" (16)	396	410	594	691	487	703	802
TP	234.173	Ea.	3/4" (19)	396	410	594	691	487	703	802
TP	234.182	Ea.	9/16" (14)	443	458	620	707	524	718	804
TP	234.185	Ea.	11/16" (17)	484	498	682	779	575	791	890
TP	234.310	Ea.	13/16" (20)	484	498	682	779	575	791	890
(358) 3-5/8" Rail Height										
SQ	225.087	Ea.	3/8" (10)	228	257	448	519	351	492	591
SQ	225.010	Ea.	1/2" (12)	228	257	448	519	351	492	591
SQ	225.215	Ea.	5/8" (16)	254	281	473	544	369	518	617
SQ	225.060	Ea.	3/4" (19)	254	281	473	544	369	518	617
SQ	225.101	Ea.	9/16" (14)	316	345	536	607	439	580	679
SQ	225.102	Ea.	11/16" (17)	342	369	561	632	457	606	705
SQ	225.315	Ea.	13/16" (20)	342	369	561	632	457	606	705
TP	225.090	Ea.	3/8" (10)	228	257	448	519	351	492	591
TP	225.030	Ea.	1/2" (12)	228	257	448	519	351	492	591
TP	225.234	Ea.	9/16" (14)	316	345	536	607	439	580	679
(4) 4" Rail Height										
SQ	225.416	Ea.	3/8" (10)	228	257	448	519	351	492	591
SQ	225.410	Ea.	1/2" (12)	228	257	448	519	351	492	591
SQ	225.103	Ea.	9/16" (14)	316	345	536	607	439	580	679
TP	225.440	Ea.	3/8" (10)	228	257	448	519	351	492	591
TP	225.430	Ea.	1/2" (12)	228	257	448	519	351	492	591
TP	225.236	Ea.	9/16" (14)	316	345	536	607	439	580	679

DRS Rails, Channels & Accessories
Patch Fittings & Designer Pivots
Offset Hung Patch Fittings
Headers & Accessories
Closers & Hardware
Locksets
Pulls & Handles
Sliding Systems
MANET
Panic Hardware

				Standard Finishes \$				Custom Finishes \$		
DRS Bottom Rail Square (SQ) or Tapered (TP) with 7422 (227.002) Arm				101	108/109	503/599	600/601	700/701	199/399	299
Profile	Ref. #	U/M	Glass Thickness	③	③	⑤①	⑤①	③	①	①
(6) 6" Rail Height										
SQ	225.149	Ea.	3/8" (10)	467	486	701	716	521	727	830
SQ	225.110	Ea.	1/2" (12)	467	486	701	716	521	727	830
SQ	225.167	Ea.	5/8" (16)	493	512	728	742	550	753	856
SQ	225.160	Ea.	3/4" (19)	493	512	728	742	550	753	856
SQ	225.115	Ea.	9/16" (14)	555	574	789	804	609	815	918
SQ	225.116	Ea.	11/16" (17)	581	600	816	830	638	841	944
SQ	225.365	Ea.	13/16" (20)	581	600	816	830	638	841	944
(10) 10" Rail Height										
SQ	225.348	Ea.	3/8" (10)	685	698	969	1,031	824	973	1,073
SQ	225.310	Ea.	1/2" (12)	685	698	969	1,031	824	973	1,073
SQ	225.093	Ea.	5/8" (16)	768	781 ^{⑤①}	1,083	1,152	924	1,089	1,201
SQ	225.112	Ea.	3/4" (19)	768	781 ^{⑤①}	1,083	1,152	924	1,089	1,201
SQ	225.117	Ea.	9/16" (14)	773	786	1,057	1,119	912	1,061	1,161
SQ	225.118	Ea.	11/16" (17)	856	869	1,171	1,240	1,012	1,177	1,289

Laminated ^③ Standard or Non-Standard Fabricated; lead time up to 3 business days.
^{⑤①} Special Fabricated/Finish or Special Order; lead time up to 5 weeks.

NOTES:

- Laminated options include 1 ea. tube of adhesive (934.800) and 4 ea. mixing tips (934.805) up to 52" rail.
- Applicator gun sold separately (934.801)
- Specify overall rail size and finish when ordering.
- Rails exceeding 48" (1219) will add a list charge per 12" (305), rounding up the next full foot dimension (i.e. between 48"- 52").
- All 108 finish DRS Rails will be provided with black (109) end caps.
- Reference Options and Prep Charges at the end of rail section.

Accessories

Model	U/M	Ref. #	Description	List \$
8852	Ea.	928.055	7/8" End Load Bottom Arm, RTS	46
355.1	Ea.	904.020	Bottom Rail Insert for 15 mm Pin	37
7422	Ea.	227.002	Bottom Rail Adjustable Insert	61
LGAA	Ea.	934.801	3M™ Scotch-Weld™ EPX™ plus II applicator with 2:1 and 1:1 plunger	330
LGA	Ea.	934.800	3M™ Scotch-Weld™ Urethane Adhesive, DP 605 NS, off white, 1 tube per 52" of pre-assembled rail	78
MTIPS	Set	934.805	3M™ Scotch-Weld™ EPX™ plus II mixing square nozzle, 5.3 mm (4 tips per set)	10
				List Add \$
PANIC			Prep for Glass Panic/Deadbolt Push Bar Device in rail	80
ELCK PREP			dormakaba EMSL Shearlock, or EML Magnetic Lock armature preparation and installation in DRS rail	175
HDWPREP			Prep and Install of non-standard dormakaba hardware (i.e., offset pivots, arms, etc.) in DRS rail	80
CMP HDWP			Competitors hardware only prep. in DRS rail (charge may be reviewed based on complexity)	95
CMP HDWI			Competitors hardware preparation and installation in DRS rails	160
CMP SHEAR			Competitors Electro-Magnetic Shear Lock or Magnetic Lock Armature Preparation only in DRS rails	300
MITER			Miter cut charge	65
				Net Add \$
POWDER			All Custom powder coated orders will include a net charge per purchase order.	200

NOTE: Scotch-Weld™ Urethane Adhesive, Scotch-Weld™ EPX™ plus II applicator, and Scotch-Weld™ EPX™ plus II mixing square nozzle are trademarks of 3M.

DRS Bottom Rails, Locking

Default 1/2" (12) unless otherwise specified

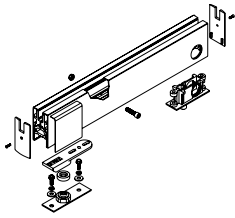

Square (SQ) DRS Bottom Rail Locking – 8852 (928.055) Pivot

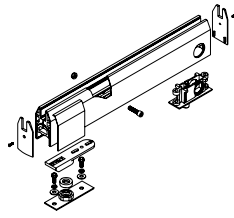

Tapered (TP) DRS Bottom Rail Locking – 8852 (928.055) Pivot

Select Service DRS Locking Bottom Rail Square (SQ) with 8852 (928.055) Pivot						
Profile	Ref. #	U/M	Glass Thickness	101	108	700
(25) 2-1/2" Rail Height						
SQ	234.017.SS	Ea.	1/2" (12)	378	393	459
(358) 3-5/8" Rail Height						
SQ	225.005.SS	Ea.	1/2" (12)	251	—	374

		Standard Finishes \$					Custom Finishes \$			
DRS Locking Bottom Rail Square (SQ) or Tapered (TP) with 8852 (928.055) Pivot				101	108/109	503/599	600/601	700/701	199/399	299
Profile	Ref. #	U/M	Glass Thickness	3	3	SO	SO	3	Q	Q
(25) 2-1/2" Rail Height										
SQ	234.067	Ea.	3/8" (10)	416	431	593	680	497	691	777
SQ	234.017	Ea.	1/2" (12)	416	431	593	680	497	691	777
SQ	234.216	Ea.	5/8" (16)	457	471	655	752	548	764	863
SQ	234.222	Ea.	3/4" (19)	457	471	655	752	548	764	863
SQ	234.186	Ea.	9/16" (14)	504	519	681	768	585	779	865
SQ	234.189	Ea.	11/16" (17)	545	559	743	840	636	852	951
SQ	234.304	Ea.	13/16" (20)	545	559	743	840	636	852	951
TP	234.070	Ea.	3/8" (10)	416	431	593	680	497	691	777
TP	234.031	Ea.	1/2" (12)	416	431	593	680	497	691	777
TP	234.101	Ea.	5/8" (16)	457	471	655	752	548	764	863
TP	234.104	Ea.	3/4" (19)	457	471	655	752	548	764	863
TP	234.192	Ea.	9/16" (14)	504	519	681	768	585	779	865
TP	234.195	Ea.	11/16" (17)	545	559	743	840	636	852	951
TP	234.311	Ea.	13/16" (20)	545	559	743	840	636	852	951
(358) 3-5/8" Rail Height										
SQ	225.079	Ea.	3/8" (10)	251	280	471	542	374	515	614
SQ	225.005	Ea.	1/2" (12)	251	280	471	542	374	515	614
SQ	225.210	Ea.	5/8" (16)	277	304	496	567	392	541	640
SQ	225.055	Ea.	3/4" (19)	277	304	496	567	392	541	640
SQ	225.119	Ea.	9/16" (14)	339	368	559	630	462	603	702
SQ	225.120	Ea.	11/16" (17)	365	392	584	655	480	629	728
SQ	225.316	Ea.	13/16" (20)	365	392	584	655	480	629	728
TP	225.082	Ea.	3/8" (10)	251	280	471	542	374	515	614
TP	225.025	Ea.	1/2" (12)	251	280	471	542	374	515	614
TP	225.238	Ea.	9/16" (14)	339	368	559	630	462	603	702

DRS Rails, Channels & Accessories
Patch Fittings & Designer Pivots
Offset Hung Patch Fittings
Headers & Accessories
Closers & Hardware
Locksets
Pulls & Handles
Sliding Systems
MANET
Panic Hardware

Select Service DRS Locking Bottom Rail Square (SQ) with 8852 (928.055) Pivot				101	700
Profile	Ref. #	U/M	Glass Thickness	①	①
(4) 4" Rail Height					
SQ	225.405.SS	Ea.	1/2" (12)	251	374

DRS Locking Bottom Rail Square (SQ) or Tapered (TP) with 8852 (928.055) Pivot				Standard Finishes \$				Custom Finishes \$		
Profile	Ref. #	U/M	Glass Thickness	③	③	Ⓢ	Ⓢ	③	Ⓢ	
(4) 4" Rail Height										
SQ	225.411	Ea.	3/8" (10)	251	280	471	542	374	515	614
SQ	225.405	Ea.	1/2" (12)	251	280	471	542	374	515	614
SQ	225.121	Ea.	9/16" (14)	339	368	559	630	462	603	702
TP	225.432	Ea.	3/8" (10)	251	280	471	542	374	515	614
TP	225.425	Ea.	1/2" (12)	251	280	471	542	374	515	614
TP	225.240	Ea.	9/16" (14)	339	368	559	630	462	603	702
(6) 6" Rail Height										
SQ	225.144	Ea.	3/8" (10)	490	509	724	739	544	750	853
SQ	225.105	Ea.	1/2" (12)	490	509	724	739	544	750	853
SQ	225.153	Ea.	5/8" (16)	516	535	751	765	573	776	879
SQ	225.155	Ea.	3/4" (19)	516	535	751	765	573	776	879
SQ	225.123	Ea.	9/16" (14)	578	597	812	827	632	838	941
SQ	225.124	Ea.	11/16" (17)	604	623	839	853	661	864	967
SQ	225.366	Ea.	13/16" (20)	604	623	839	853	661	864	967
(10) 10" Rail Height										
SQ	225.343	Ea.	3/8" (10)	708	721	992	1,054	847	996	1,096
SQ	225.305	Ea.	1/2" (12)	708	721	992	1,054	847	996	1,096
SQ	225.127	Ea.	5/8" (16)	791	804 Ⓢ	1,106	1,175	947	1,112	1,224
SQ	225.128	Ea.	3/4" (19)	791	804 Ⓢ	1,106	1,175	947	1,112	1,224
SQ	225.125	Ea.	9/16" (14)	796	809	1,080	1,142	935	1,084	1,184
SQ	225.126	Ea.	11/16" (17)	879	892	1,194	1,263	1,035	1,200	1,312

- Laminated**
- ① Non-Fabricated item, ships in 1 business day.
 - ③ Standard or Non-Standard Fabricated; lead time up to 3 business days.
 - Ⓢ Special Fabricated/Finish or Special Order; lead time up to 5 weeks.

- NOTES:**
- Laminated options include 1 ea. tube of adhesive (934.800) and 4 ea. mixing tips (934.805) up to 52" rail.
 - Applicator gun sold separately (934.801)
 - Specify overall rail size and finish when ordering.
 - Rails exceeding 48" (1219) will add a list charge per 12" (305), rounding up the next full foot dimension (i.e. between 48" - 52").
 - Base Price Includes Rail, Rail Covers/Cladding where appropriate, End Caps and Installed Hardware.
 - All 108 finish DRS Rails will be provided with black (109) end caps.
 - Reference Options and Prep Charges at the end of rail section.

DRS Bottom Rails, Locking

Default 1/2" (12) unless otherwise specified

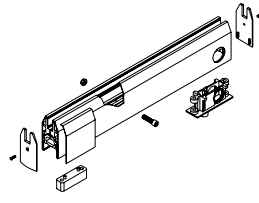
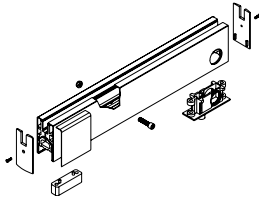

Square (SQ) DRS Bottom Rail
Locking — 355.1 (904.020) Insert

Tapered (TP) DRS Bottom Rail
Locking — 355.1 (904.020) Insert

				Standard Finishes \$					Custom Finishes \$	
DRS Locking Bottom Rail Square (SQ) or Tapered (TP) with 355.1 (904.020) Insert				101	108/109	503/599	600/601	700/701	199/399	299
Profile	Ref. #	U/M	Glass Thickness	3	3	50	50	3	Q	Q
(358) 3-5/8" Rail Height										
SQ	225.080	Ea.	3/8" (10)	243	272	463	534	366	507	606
SQ	225.007	Ea.	1/2" (12)	243	272	463	534	366	507	606
SQ	225.211	Ea.	5/8" (16)	269	296	488	559	384	533	632
SQ	225.057	Ea.	3/4" (19)	269	296	488	559	384	533	632
SQ	225.129	Ea.	9/16" (14)	331	360	551	622	454	595	694
SQ	225.130	Ea.	11/16" (17)	357	384	576	647	472	621	720
SQ	225.317	Ea.	13/16" (20)	357	384	576	647	472	621	720
TP	225.083	Ea.	3/8" (10)	243	272	463	534	366	507	606
TP	225.027	Ea.	1/2" (12)	243	272	463	534	366	507	606
TP	225.242	Ea.	9/16" (14)	331	360	551	622	454	595	694
(4) 4" Rail Height										
SQ	225.412	Ea.	3/8" (10)	243	272	463	534	366	507	606
SQ	225.407	Ea.	1/2" (12)	243	272	463	534	366	507	606
SQ	225.131	Ea.	9/16" (14)	331	360	551	622	454	595	694
TP	225.433	Ea.	3/8" (10)	243	272	463	534	366	507	606
TP	225.427	Ea.	1/2" (12)	243	272	463	534	366	507	606
TP	225.244	Ea.	9/16" (14)	331	360	551	622	454	595	694
(6) 6" Rail Height										
SQ	225.145	Ea.	3/8" (10)	482	501	716	731	536	742	845
SQ	225.107	Ea.	1/2" (12)	482	501	716	731	536	742	845
SQ	225.162	Ea.	5/8" (16)	508	527	743	757	565	768	871
SQ	225.157	Ea.	3/4" (19)	508	527	743	757	565	768	871
SQ	225.133	Ea.	9/16" (14)	570	589	804	819	624	830	933
SQ	225.134	Ea.	11/16" (17)	596	615	831	845	653	856	959
SQ	225.367	Ea.	13/16" (20)	596	615	831	845	653	856	959

DRS Rails, Channels & Accessories
Patch Fittings & Designer Pivots
Offset Hung Patch Fittings
Headers & Accessories
Closers & Hardware
Locksets
Pulls & Handles
Sliding Systems
MANET
Panic Hardware

				Standard Finishes \$					Custom Finishes \$	
DRS Locking Bottom Rail Square (SQ) or Tapered (TP) with 355.1 (904.020) Insert				101	108/109	503/599	600/601	700/701	199/399	299
Profile	Ref. #	U/M	Glass Thickness	3	3	SO	SO	3	Q	Q
(10) 10" Rail Height										
SQ	225.345	Ea.	3/8" (10)	700	713	984	1,046	839	988	1,088
SQ	225.307	Ea.	1/2" (12)	700	713	984	1,046	839	988	1,088
SQ	225.137	Ea.	5/8" (16)	783	796 ^{SO}	1,098	1,167	939	1,104	1,216
SQ	225.138	Ea.	3/4" (19)	783	796 ^{SO}	1,098	1,167	939	1,104	1,216
SQ	225.135	Ea.	9/16" (14)	788	801	1,072	1,134	927	1,076	1,176
SQ	225.136	Ea.	11/16" (17)	871	884	1,186	1,255	1,027	1,192	1,304

Laminated ³ Standard or Non-Standard Fabricated; lead time up to 3 business days.
^{SO} Special Fabricated/Finish or Special Order; lead time up to 5 weeks.

NOTES:

- Laminated options include 1 ea. tube of adhesive (934.800) and 4 ea. mixing tips (934.805) up to 52" rail.
- Applicator gun sold separately (934.801)
- Specify overall rail size and finish when ordering.
- Rails exceeding 48" (1219) will add a list charge per 12" (305), rounding up the next full foot dimension (i.e. between 48" - 52").
- Base Price Includes Rail, Rail Covers/Cladding where appropriate, End Caps and Installed Hardware.
- All 108 finish DRS Rails will be provided with black (109) end caps.
- Reference Options and Prep Charges at the end of rail section.

DRS Bottom Rails, Locking

Default 1/2" (12) unless otherwise specified

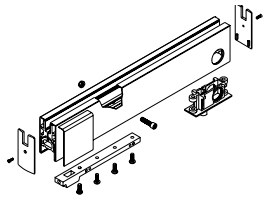

Square (SQ) DRS Bottom Rail Locking – 7422 (227.002) Arm

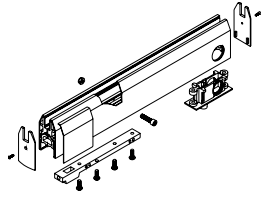

Tapered (TP) DRS Bottom Rail Locking – 7422 (227.002) Arm

				Standard Finishes \$					Custom Finishes \$	
DRS Locking Bottom Rail Square (SQ) or Tapered (TP) with 7422 (227.002) Arm				101	108/109	503/599	600/601	700/701	199/399	299
Profile	Ref. #	U/M	Glass Thickness	3	3	SO	SO	3	Q	Q
(25) 2-1/2" Rail Height										
SQ	234.069	Ea.	3/8" (10)	432	447	609	696	513	707	793
SQ	234.019	Ea.	1/2" (12)	432	447	609	696	513	707	793
SQ	234.218	Ea.	5/8" (16)	473	487	671	768	564	780	879
SQ	234.226	Ea.	3/4" (19)	473	487	671	768	564	780	879
SQ	234.188	Ea.	9/16" (14)	520	535	697	784	601	795	881
SQ	234.191	Ea.	11/16" (17)	561	575	759	856	652	868	967
SQ	234.305	Ea.	13/16" (20)	561	575	759	856	652	868	967
TP	234.072	Ea.	3/8" (10)	432	447	609	696	513	707	793
TP	234.035	Ea.	1/2" (12)	432	447	609	696	513	707	793
TP	234.103	Ea.	5/8" (16)	473	487	671	768	564	780	879
TP	234.115	Ea.	3/4" (19)	473	487	671	768	564	780	879
TP	234.194	Ea.	9/16" (14)	520	535	697	784	601	795	881
TP	234.197	Ea.	11/16" (17)	561	575	759	856	652	868	967
TP	234.312	Ea.	13/16" (20)	561	575	759	856	652	868	967
(358) 3-5/8" Rail Height										
SQ	225.081	Ea.	3/8" (10)	267	296	487	558	390	531	630
SQ	225.009	Ea.	1/2" (12)	267	296	487	558	390	531	630
SQ	225.212	Ea.	5/8" (16)	293	320	512	583	408	557	656
SQ	225.059	Ea.	3/4" (19)	293	320	512	583	408	557	656
SQ	225.168	Ea.	9/16" (14)	355	384	575	646	478	619	718
SQ	225.169	Ea.	11/16" (17)	381	408	600	671	496	645	744
SQ	225.318	Ea.	13/16" (20)	381	408	600	671	496	645	744
TP	225.084	Ea.	3/8" (10)	267	296	487	558	390	531	630
TP	225.029	Ea.	1/2" (12)	267	296	487	558	390	531	630
TP	225.246	Ea.	9/16" (14)	355	384	575	646	478	619	718

DRS Rails, Channels & Accessories
Patch Fittings & Designer Pivots
Offset Hung Patch Fittings
Headers & Accessories
Closers & Hardware
Locksets
Pulls & Handles
Sliding Systems
MANET
Panic Hardware

Standard Finishes \$

Custom Finishes \$

DRS Locking Bottom Rail Square (SQ) or Tapered (TP) with 7422 (227.002) Arm				101	108/109	503/599	600/601	700/701	199/399	299
Profile	Ref. #	U/M	Glass Thickness	3	3	SO	SO	3	Q	Q
(4) 4" Rail Height										
SQ	225.413	Ea.	3/8" (10)	267	296	487	558	390	531	630
SQ	225.418	Ea.	1/2" (12)	267	296	487	558	390	531	630
SQ	225.170	Ea.	9/16" (14)	355	384	575	646	478	619	718
TP	225.434	Ea.	3/8" (10)	267	296	487	558	390	531	630
TP	225.429	Ea.	1/2" (12)	267	296	487	558	390	531	630
TP	225.248	Ea.	9/16" (14)	355	384	575	646	478	619	718
(6) 6" Rail Height										
SQ	225.146	Ea.	3/8" (10)	506	525	740	755	560	766	869
SQ	225.109	Ea.	1/2" (12)	506	525	740	755	560	766	869
SQ	225.166	Ea.	5/8" (16)	532	551	767	781	589	792	895
SQ	225.159	Ea.	3/4" (19)	532	551	767	781	589	792	895
SQ	225.172	Ea.	9/16" (14)	594	613	828	843	648	854	957
SQ	225.173	Ea.	11/16" (17)	620	639	855	869	677	880	983
SQ	225.368	Ea.	13/16" (20)	620	639	855	869	677	880	983
(10) 10" Rail Height										
SQ	225.347	Ea.	3/8" (10)	724	737	1,008	1,070	863	1,012	1,112
SQ	225.309	Ea.	1/2" (12)	724	737	1,008	1,070	863	1,012	1,112
SQ	225.139	Ea.	5/8" (16)	807	820 SO	1,122	1,191	963	1,128	1,240
SQ	225.208	Ea.	3/4" (19)	807	820 SO	1,122	1,191	963	1,128	1,240
SQ	225.174	Ea.	9/16" (14)	812	825	1,096	1,158	951	1,100	1,200
SQ	225.175	Ea.	11/16" (17)	895	908	1,210	1,279	1,051	1,216	1,328

Laminated 3 Standard or Non-Standard Fabricated; lead time up to 3 business days.
 SO Special Fabricated/Finish or Special Order; lead time up to 5 weeks.

NOTES:

- Laminated options include 1 ea. tube of adhesive (934.800) and 4 ea. mixing tips (934.805) up to 52" rail.
- Applicator gun sold separately (934.801)
- Specify overall rail size and finish when ordering.
- Rails exceeding 48" (1219) will add a list charge per 12" (305), rounding up the next full foot dimension (i.e. between 48"- 52").
- Base Price Includes Rail, Rail Covers/Cladding where appropriate, End Caps and Installed Hardware.
- All 108 finish DRS Rails will be provided with black (109) end caps.
- Reference Options and Prep Charges at the end of rail section.

Options and Prep Charges

Model	U/M	Ref. #	Description	101/108 ③	500/501 ⁽⁵⁰⁾
CYLDUMY	—	—	Cylinder x Dummy	36	36
CYLXYL	—	—	Cylinder x Cylinder	42	42
CYLXTT	—	—	Cylinder x Thumb Turn	42	42
TTXDUMY	—	—	Thumb Turn x Dummy	36	36
TTXTT	—	—	Thumb Turn x Thumb Turn	42	42
CYL	—	225.999	Mortise Cylinder for DRS Lock, with split ring	21	21
TT	—	225.998	Mortise Thumb Turn for DRS Lock, with split ring	21	21
DUMY	—	225.994	Mortise Dummy (Blank) Cylinder for DRS Lock, with split ring	15	15
					List \$
8852	Ea.	928.055	7/8" (22) End Load Bottom Arm, RTS		46
355.1	Ea.	904.020	Bottom Rail Insert for 15 mm Pin		37
7422	Ea.	227.002	Bottom Rail Adjustable Insert		61
BRASSLK 1916	Ea.	925.019	Bottom Rail Brass Door Lock, 1-9/16" (40) (5/8" (16) Throw)		39
BRASSLK 1916L	Ea.	925.119	Bottom Rail Brass Door Lock 1-9/16" (7/8" long throw fully retracted projects 1/4" below lock base)		54
BRASSLK 178	Ea.	925.018	Bottom Rail Brass Door Lock 1-15/16" (5/8" Throw). Not for use with DRS Rails. Requires 1-15/16" lock height clearance in rail		41
BRASSLK 25	Ea.	934.018	Bottom Rail Brass Door Lock, 1-9/16" (5/8" Throw) Modified for 2-1/2" Rail Only		77
BRASSLK 1916L 25	Ea.	934.017	Bottom Rail Brass Door Lock 1-9/16" (7/8" long throw fully retracted projects 1/4" below lock base) Modified for 2-1/2" Rail Only		90
LGAA	Ea.	934.801	3M™ Scotch-Weld™ EPX™ plus II applicator with 2:1 and 1:1 plunger		330
LGA	Ea.	934.800	3M™ Scotch-Weld™ Urethane Adhesive, DP 605 NS, off white, 1 tube per 52" of pre-assembled rail		78
MTIPS	Set	934.805	3M™ Scotch-Weld™ EPX™ plus II mixing square nozzle, 5.3 mm (4 tips per set)		10
					List Add \$
PANIC			Prep for Glass Panic/Deadbolt Push Bar Device in rail		80
ELCK PREP			dormakaba EMSL Shearlock, or EML Magnetic Lock armature preparation and installation in DRS rail		175
HDWPREP			Prep and Install of non-standard dormakaba hardware (i.e., offset pivots, arms, etc.) in DRS rail		80
CMP HDWP			Competitors hardware only prep. in DRS rail (charge may be reviewed based on complexity)		95
CMP HDWI			Competitors hardware preparation and installation in DRS rails		160
CMP SHEAR			Competitors Electro-Magnetic Shear Lock or Magnetic Lock Armature Preparation only in DRS rails		300
MITER			Miter cut charge		65
					Net Add \$
POWDER			All Custom powder coated orders will include a net charge per purchase order.		200

NOTE: Scotch-Weld™ Urethane Adhesive, Scotch-Weld™ EPX™ plus II applicator, and Scotch-Weld™ EPX™ plus II mixing square nozzle are trademarks of 3M.

DRS Rails,
Channels &
AccessoriesPatch Fittings
& Designer
PivotsOffset
Hung Patch
FittingsHeaders &
AccessoriesClosers &
Hardware









Locksets

Pulls &
HandlesSliding
Systems

MANET

Panic
Hardware



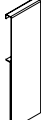

DRS Rail Covers and Endcaps

				Standard Finishes \$					Custom Finishes \$	
				101	108/109	503/599	600/601	700/701	199/399	299
Ref. #	U/M	Description	③	③	⑤0	⑤0	③	①	①	
2-1/2" Square Rail Covers										
	934.028	Ft. Anodized (3/8"-9/16" [8-14])	10	14	—	—	—	34	—	
	234.569	Ft. Cladded (3/8"-9/16" [8-14])	—	—	41	51	25	—	88	
	934.004	Ft. Anodized (5/8"-13/16" [16-20])	10	14	—	—	—	34	—	
	234.564	Ft. Cladded (5/8"-13/16" [16-20])	—	—	41	51	25	—	88	
2-1/2" Tapered Rail Covers										
	934.029	Ft. Anodized (3/8"-9/16" [8-14])	10	14	—	—	—	34	—	
	234.568	Ft. Cladded (3/8"-9/16" [8-14])	—	—	41	51	25	—	88	
	934.003	Ft. Anodized (5/8"-13/16" [16-20])	10	14	—	—	—	34	—	
	234.560	Ft. Cladded (5/8"-13/16" [16-20])	—	—	41	51	25	—	88	
3-5/8" Square Rail Cover										
	925.035	Ft. Anodized (3/8"-9/16" [8-14])	7	12	—	—	—	29	—	
	225.502	Ft. Cladded (3/8"-9/16" [8-14])	—	—	34	43	20	—	73	
	925.535	Ft. Anodized (5/8"-13/16" [16-20])	7	12	—	—	—	29	—	
	225.505	Ft. Cladded (5/8"-13/16" [16-20])	—	—	34	43	20	—	73	
3-5/8" Tapered Rail Cover										
	925.036	Ft. Anodized (3/8"-9/16" [8-14])	7	12	—	—	—	29	—	
	225.503	Ft. Cladded (3/8"-9/16" [8-14])	—	—	34	43	20	—	73	
4" Square Rail Cover										
	925.735	Ft. Anodized (3/8"-9/16" [8-14])	7	12	—	—	—	29	—	
	225.508	Ft. Cladded (3/8"-9/16" [8-14])	—	—	34	43	20	—	73	
4" Tapered Rail Cover										
	925.739	Ft. Anodized (3/8"-9/16" [8-14])	7	12	—	—	—	29	—	
	225.509	Ft. Cladded (3/8"-9/16" [8-14])	—	—	34	43	20	—	73	
6" Square Rail Cover										
	925.042	Ft. Anodized (3/8"-9/16" [8-14])	13	20	—	—	—	35	—	
	225.506	Ft. Cladded (3/8"-9/16" [8-14])	—	—	45	46	30	—	78	
	925.542	Ft. Anodized (5/8"-13/16" [16-20])	13	20	—	—	—	35	—	
	225.559	Ft. Cladded (5/8"-13/16" [16-20])	—	—	45	46	30	—	78	
10" Square Rail Cover										
	925.205	Ft. Anodized (3/8"-9/16" [8-14])	41	43	—	—	—	68	—	
	225.525	Ft. Cladded (3/8"-9/16" [8-14])	—	—	85	89	64	—	150	
	925.206	Ft. Anodized (5/8"-13/16" [16-20])	54	63	—	—	—	104	—	
	225.919	Ft. Cladded (5/8"-13/16" [16-20])	—	—	97	102	77	—	163	

- ① Non-Fabricated item, ships in 1 business day.
- ③ Standard or Non-Standard Fabricated; lead time up to 3 business days.
- ⑤0 Special Fabricated/Finish or Special Order; lead time up to 5 weeks.

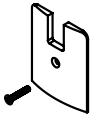
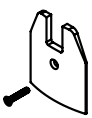
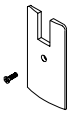
NOTES:

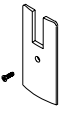
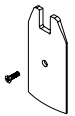
- Must specify length when ordering. dormakaba will cut to specified size, priced per foot (ft.) only.
- Maximum length for extrusion is 144" (3.7 m) before requiring splice/joint; 120" (3 m) for brass or bronze finish.
- 3-5/8" SQ End Cap available Select Service in 101, 108, and 700; 4" SQ End Cap available in 101 and 700.

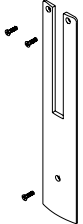
Model	Ref. #	U/M	Description	Standard Finishes \$			Custom Finishes \$		
				101/109	503/599/600/601	618/619	199/399	299	
				3	50	3	Q	Q	
2-1/2" Square Rail End Caps									
	934.040	Ea.	Anodized (3/8"-9/16" [8-14])	18	—	—	54	—	
	934.041	Ea.	Cladded (3/8"-9/16" [8-14])	—	42	36	—	54	
	934.036	Ea.	Anodized (5/8"-13/16" [16-20])	18	—	—	54	—	
	934.037	Ea.	Cladded (5/8"-13/16" [16-20])	—	42	36	—	54	
2-1/2" Tapered Rail End Caps									
	934.038	Ea.	Anodized (3/8"-9/16" [8-14])	18	—	—	54	—	
	934.039	Ea.	Cladded (3/8"-9/16" [8-14])	—	42	36	—	54	
	934.034	Ea.	Anodized (5/8"-13/16" [16-20])	18	—	—	54	—	
	934.035	Ea.	Cladded (5/8"-13/16" [16-20])	—	42	36	—	54	
3-5/8" Square Rail End Caps									
	925.033	Ea.	Anodized (3/8"-9/16" [8-14])	14	—	—	43	—	
	925.233	Ea.	Cladded (3/8"-9/16" [8-14])	—	86	30	—	86	
	925.533	Ea.	Anodized (5/8"-13/16" [16-20])	14	—	—	43	—	
	925.534	Ea.	Cladded (5/8"-13/16" [16-20])	—	86	30	—	86	
3-5/8" Tapered Rail End Caps									
	925.034	Ea.	Anodized (3/8"-9/16" [8-14])	14	—	—	43	—	
	925.234	Ea.	Cladded (3/8"-9/16" [8-14])	—	86	30	—	86	
4" Square Rail End Caps									
	925.733	Ea.	Anodized (3/8"-9/16" [8-14])	14	—	—	43	—	
	925.732	Ea.	Cladded (3/8"-9/16" [8-14])	—	86	30	—	86	
4" Tapered Rail End Caps									
	925.737	Ea.	Anodized (3/8"-9/16" [8-14])	14	—	—	43	—	
	925.738	Ea.	Cladded (3/8"-9/16" [8-14])	—	86	30	—	86	
6" Square Rail End Caps									
	925.028	Ea.	Anodized (3/8"-9/16" [8-14])	60	—	—	88	—	
	925.526	Ea.	Cladded (3/8"-9/16" [8-14])	—	68	65	—	104	
	925.528	Ea.	Anodized (5/8"-13/16" [16-20])	60	—	—	88	—	
	925.527	Ea.	Cladded (5/8"-13/16" [16-20])	—	68	65	—	104	
10" Square Rail End Caps									
	925.240	Ea.	Anodized (3/8"-9/16" [8-14])	74	—	—	121	—	
	925.241	Ea.	Cladded (3/8"-9/16" [8-14])	—	93	89	—	121	
					<u>101</u>	<u>109</u>		<u>199/399</u>	<u>299</u>
					3	50		Q	Q
	925.923	Ea.	Anodized (5/8"-13/16" [16-20])	96	96	—	—	149	—
925.924	Ea.	Cladded (5/8"-13/16" [16-20])	—	—	114	111	—	149	
POWDER All Custom powder coated orders will include a net charge per purchase order Net Add \$ 200									

NOTES: • 3-5/8" SQ End Cap available Select Service in 101, 108, and 700; 4" SQ End Cap available in 101 and 700.
 • End caps not available in true stainless steel. 500/501 Satin/Polished Chrome end caps supplied when 700/701 finish rails are ordered.
 • 619 satin nickel and 618 polished nickel supplied in place of 700 satin stainless and 701 polished stainless respectively.

DRS Rails, Channels & Accessories
 Patch Fittings & Designer Pivots
 Offset Hung Patch Fittings
 Headers & Accessories
 Closers & Hardware
 Locksets
 Pulls & Handles
 Sliding Systems
 MANET
 Panic Hardware

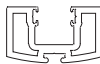
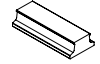
Model	Ref. #	U/M	Description	Standard Finishes \$			Custom Finishes \$		
				101	108/109	599	700/701	199/399	299
				3	3	SO	3	Q	Q
DRS Dri-Fit® Vertical Stile*									
	225.280	Ea.	3/8" (10)	177	225	525	433	557	575
	225.281	Ea.	1/2" (12)	177	225	525	433	557	575
			<ul style="list-style-type: none"> *. Vertical stiles for both glass thicknesses are priced as one (1) length and include end load cap and Dri-Fit® gasket. • Maximum length of 144" (3658) anodized or 120" (3048) clad. • 1-1/8" (29) x 1-7/8" (48) wide. • Requires Weather Brush or Seal. • Not available for 2-1/2" DRS rails. • Please provide total width of clear opening size (allows factory to make correct deductions for production). 						
									List \$
Weather Brush or Weather Seal									
	925.289	Ft.	Weather Brush						2
	925.288	Ft.	Weather Seal (Vinyl)						2

- ① Non-Fabricated item, ships in 1 business day.
- 3 Standard or Non-Standard Fabricated; lead time up to 3 business days.
- SO Special Fabricated/Finish or Special Order; lead time up to 5 weeks.

NOTE: DRS 10" Rails will project 1/32" (l) at both leading edges beyond the vertical door surface if combined with dormakaba Vertical Stiles.

DRS Dri-Fit® Sidelite Rails

Ordering Guide

Ordered Less Covers or Cladding —		NO	Rail Length	Specify	TP — Tapered Rail ¹	SQ — Square Rail	Dri-Fit® End Cap	Miter	Dri-Fit® Sidelite Profile	Dri-Fit® Saddle Height	Dri-Fit® Saddle Finish
							NONE EC2 EC1	0 1 2	1/2 3/8 3/4 1/4 1/8 NO	100 — Mill Aluminum 109 — Black Aluminum	
SDLT	358		35-3/4	SQ	1/2	101	EC2	0			100
SDLT	25	— 2-1/2" Dri-Fit™ sidelite Rail			1/2	101					
Dri-Fit® Model	358	— 3-5/8" Dri-Fit™ sidelite Rail			3/8	108					
	4	— 4" Dri-Fit™ sidelite Rail			9/16	109					
	6	— 6" Dri-Fit™ sidelite Rail			5/8	503					
	10	— 10" Dri-Fit™ sidelite Rail			11/16	599					
Dri-Fit® Rail Height					3/4	600					
					13/16	601					
						700					
						701					

- 1 Tapered Rail (TP) available with 2-1/2", 3-5/8", and 4" rails.
- 2 5/8" and 3/4" glass available only with 2-1/2", 3-5/8", 6", and 10" rails.
- 3 dormakaba reserves the right to refuse Custom Finishes.
- 4 All Custom Finishes require customer sign-off/approval of color chip.

Standard Finish

199	— Custom Anodized (Specify)
299	— Custom Cladding (Specify)
399	— Custom Paint or Powder Coat (Specify)

Finish Custom^{3,4}

- DRS Rails, Channels & Accessories
- Patch Fittings & Designer Pivots
- Offset Hung Patch Fittings
- Headers & Accessories
- Closers & Hardware
- Locksets
- Pulls & Handles
- Sliding Systems
- MANET
- Panic Hardware

DRS Dri-Fit® Sidelite Rails

				Standard Finishes \$			Custom Finishes \$			
DRS Dri-Fit® Sidelite Rails				101/108	109	503/599 600/601	700/701	199/399	299	
Profile	Ref. #	U/M	Glass Thickness	③	③	ⓈO	③	ⓈQ	ⓈQ	
Note: Dri-Fit® gasket shipped installed for cut to length orders; shipped loose for full length orders.										
(25) 2-1/2" Rail Height										
SQ	234.052	Ft.	3/8" (10)	40	48	140	83	77	179	
		Ln.		431	525	1,333	937	867	2,066	
SQ	234.046	Ft.	1/2" (12) & 9/16" (14)	40	48	140	83	77	179	
		Ln.		431	525	1,333	937	867	2,066	
SQ	234.232	Ft.	5/8" (16) & 11/16" (17)	40	48	140	83	77	179	
		Ln.		431	525	1,333	937	867	2,066	
SQ	234.233	Ft.	3/4" (19) & 13/16" (20)	40	48	140	83	77	179	
		Ln.		431	525	1,333	937	867	2,066	
TP	234.230	Ft.	3/8" (10)	40	48	140	83	77	179	
		Ln.		431	525	1,333	937	867	2,066	
TP	234.231	Ft.	1/2" (12) & 9/16" (14)	40	48	140	83	77	179	
		Ln.		431	525	1,333	937	867	2,066	
TP	234.134	Ft.	5/8" (16) & 11/16" (17)	40	48	140	83	77	179	
		Ln.		431	525	1,333	937	867	2,066	
TP	234.135	Ft.	3/4" (19) & 13/16" (20)	40	48	140	83	77	179	
		Ln.		431	525	1,333	937	867	2,066	
(358) 3-5/8" Rail Height										
SQ	225.200	Ft.	3/8" (10)	44	50	118	73	66	150	
		Ln.		478	549	1,117	819	737	1,725	
SQ	225.201	Ft.	1/2" (12) & 9/16" (14)	44	50	118	73	66	150	
		Ln.		478	549	1,117	819	737	1,725	
SQ	225.100	Ft.	5/8" (16) & 11/16" (17)	44	50	118	73	66	150	
		Ln.		478	549	1,117	819	737	1,725	
SQ	225.209	Ft.	3/4" (19) & 13/16" (20)	44	50	118	73	66	150	
		Ln.		478	549	1,117	819	737	1,725	
TP	225.203	Ft.	3/8" (10)	44	50	118	73	66	150	
		Ln.		478	549	1,117	819	737	1,725	
TP	225.202	Ft.	1/2" (12) & 9/16" (14)	44	50	118	73	66	150	
		Ln.		478	549	1,117	819	737	1,725	
									List Add \$	
GASKET		Install gasket charge per each stock length Dri-Fit® U-Channel							39	

③ Standard or Non-Standard Fabricated; lead time up to 3 business days.
 ⓈO Special Fabricated/Finish or Special Order; lead time up to 5 weeks.

NOTE

- Maximum length for Dri-Fit® Channel is 148" (3759) for anodized finishes, 144" (3658) for stainless steel, and 120" (3 m) for brass or bronze finishes before requiring a splice/joint.

DRS Dri-Fit® Sidelite Rails







				Standard Finishes \$			Custom Finishes \$			
DRS Dri-Fit® Sidelite Rails				101/108	109	503/599 600/601	700/701	199/399	299	
Profile	Ref. #	U/M	Glass Thickness	③	③	⑤①	③	②	②	
Note: Dri-Fit gasket shipped installed for cut to length orders; shipped loose for full length orders.										
(4) 4" Rail Height										
SQ	225.050	Ft.	3/8" (10)	44	50	118	73	66	150	
		Ln.		478	549	1,117	819	737	1,725	
SQ	225.049	Ft.	1/2" (12) & 9/16" (14)	44	50	118	73	66	150	
		Ln.		478	549	1,117	819	737	1,725	
TP	225.204	Ft.	3/8" (10)	44	50	118	73	66	150	
		Ln.		478	549	1,117	819	737	1,725	
TP	225.205	Ft.	1/2" (12) & 9/16" (14)	44	50	118	73	66	150	
		Ln.		478	549	1,117	819	737	1,725	
(6) 6" Rail Height										
SQ	225.224	Ft.	3/8" (10)	50	63	130	95	87	167	
		Ln.		549	702	1,235	1,078	984	1,925	
SQ	225.225	Ft.	1/2" (12) & 9/16" (14)	50	63	130	95	87	167	
		Ln.		549	702	1,235	1,078	984	1,925	
SQ	225.094	Ft.	5/8" (16) & 11/16" (17)	50	63	130	95	87	167	
		Ln.		549	702	1,235	1,078	984	1,925	
SQ	225.095	Ft.	3/4" (19) & 13/16" (20)	50	63	130	95	87	167	
		Ln.		549	702	1,235	1,078	984	1,925	
(10) 10" Rail Height										
SQ	225.048	Ft.	3/8" (10)	64	74	214	157	109	278	
		Ln.		714	831	2,058	1,807	1,243	3,230	
SQ	225.047	Ft.	1/2" (12) & 9/16" (14)	64	74	214	157	109	278	
		Ln.		714	831	2,058	1,807	1,243	3,230	
SQ	225.184	Ft.	5/8" (16) & 11/16" (17)	64	74	214	157	109	278	
		Ln.		714	831	2,058	1,807	1,243	3,230	
SQ	225.185	Ft.	3/4" (19)	64	74	214	157	109	278	
		Ln.		714	831	2,058	1,807	1,243	3,230	
									List Add \$	
GASKET		Install gasket charge per each stock length Dri-Fit® U-Channel							39	

③ Standard or Non-Standard Fabricated; lead time up to 3 business days.
 ⑤① Special Fabricated/Finish or Special Order; lead time up to 5 weeks.

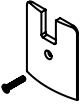
NOTE
 • Maximum length for Dri-Fit® Channel is 148" (3759) for anodized finishes, 144" (3658) for stainless steel, and 120" (3 m) for brass or bronze finishes before requiring a splice/joint.

DRS Rails, Channels & Accessories
 Patch Fittings & Designer Pivots
 Offset Hung Patch Fittings
 Headers & Accessories
 Closers & Hardware
 Locksets
 Pulls & Handles
 Sliding Systems
 MANET
 Panic Hardware

DRS Dri-Fit® Sidelite Rail Options and Accessories

				Standard Finishes \$			Custom Finishes \$		
				101/109	503/599/600/601	618/619	199/399	299	
Model	Ref. #	U/M	Description	3	SO	3	Q	Q	
2-1/2" Square Sidelite Rail End Caps									
	934.050	Ea.	Anodized (3/8"-9/16" [8-14])	18	—	—	54	—	
	934.051	Ea.	Cladded (3/8"-9/16" [8-14])	—	42	36	—	54	
	934.046	Ea.	Anodized (5/8"-13/16" [16-20])	18	—	—	54	—	
	934.047	Ea.	Cladded (5/8"-13/16" [16-20])	—	42	36	—	54	
2-1/2" Tapered Sidelite Rail End Caps									
	934.048	Ea.	Anodized (3/8"-9/16" [8-14])	18	—	—	54	—	
	934.049	Ea.	Cladded (3/8"-9/16" [8-14])	—	42	36	—	54	
	934.044	Ea.	Anodized (5/8"-13/16" [16-20])	18	—	—	54	—	
	934.045	Ea.	Cladded (5/8"-13/16" [16-20])	—	42	36	—	54	
3-5/8" Square Sidelite Rail End Caps									
	925.033	Ea.	Anodized (3/8"-9/16" [8-14])	14	—	—	43	—	
	925.233	Ea.	Cladded (3/8"-9/16" [8-14])	—	86	30	—	86	
	925.533	Ea.	Anodized (5/8"-13/16" [16-20])	14	—	—	43	—	
	925.534	Ea.	Cladded (5/8"-13/16" [16-20])	—	86	30	—	86	
3-5/8" Tapered Sidelite Rail End Caps									
	925.034	Ea.	Anodized (3/8"-9/16" [8-14])	14	—	—	43	—	
	925.234	Ea.	Cladded (3/8"-9/16" [8-14])	—	86	30	—	86	
4" Square Sidelite Rail End Caps									
	925.730	Ea.	Anodized (3/8"-9/16" [8-14])	14	—	—	43	—	
	925.731	Ea.	Cladded (3/8"-9/16" [8-14])	—	86	30	—	86	
4" Tapered Sidelite Rail End Caps									
	925.743	Ea.	Anodized (3/8"-9/16" [8-14])	14	—	—	43	—	
	925.740	Ea.	Cladded (3/8"-9/16" [8-14])	—	86	30	—	86	
Model	U/M	Ref. #	Description						List \$
SADDLE 1/8 (3)	Ft.	928.050	Saddle for 1/8" height						N/C
SADDLE 3/8 (10) and 1/2 (12)	Ft.	925.051	Saddle for 3/8" and 1/2" height						N/C
SADDLE 1/4 (6) and 3/4 (19)	Ft.	925.049	Saddle for 1/4" and 3/4" height						N/C
LSDL	Ft.	—	Less saddle per ft						Deduct 5
MITER	Ea.	—	Miter cut charge						65
								Net Add \$	
POWDER	All Custom powder coated orders will include a net charge per purchase order.							200	

3 Standard or Non-Standard Fabricated; lead time up to 3 business days.
 SO Special Fabricated/Finish or Special Order; lead time up to 5 weeks.

NOTES

- 3-5/8" SQ End Cap available Select Service in 101, 109, and 619; 4" SQ End Cap available in 101 and 619.
- End caps not available in true stainless steel. 619/618 Satin/Polished Nickel end caps supplied when 700/701 finish rails are ordered.

NOTES:

- If saddle is purchased individually, saddle is no longer no charge. Reference List price per ft. charge at end of sidelite accessory pages.
- Prices shown above are for saddles supplied with sidelite. Specify sidelite rail cut length, glass thickness, saddle height, and finish when ordering.
- Cut length of sidelite rail does not include end caps.
- Allow 3/16" per end cap ordered.
- Endcaps NOT included, please specify quantity required per sidelite.
- Saddle, gasket, and setting block included with each sidelite.
- Pricing per sidelite is per foot (ft).
- Maximum length for sidelite is 144" (3.7 m) before requiring splice/joint; 120" (3 m) for brass or bronze finish.

DRS Dri-Fit® Sidelite Rail Options and Accessories

				Standard Finishes \$			Custom Finishes \$		
				101/109	503/599/600/601	618/619	199/399	299	
6" Square Sidelite Rail End Caps							Q	Q	
	925.028	Ea.	Anodized (3/8"-9/16" [8-14])	60	-	-	88	-	
	925.526	Ea.	Cladded (3/8"-9/16" [8-14])	-	68	65	-	104	
	925.528	Ea.	Anodized (5/8"-13/16" [16-20])	60	-	-	88	-	
	925.527	Ea.	Cladded (5/8"-13/16" [16-20])	-	68	65	-	104	
10" Square Sidelite Rail End Caps									
	925.934	Ea.	Anodized (3/8"-9/16" [8-14])	74	-	-	121	-	
	925.922	Ea.	Cladded (3/8"-9/16" [8-14])	-	93	89	-	121	
					101	109		199/399	299
					3	SO		Q	Q
	925.921	Ea.	Anodized or Cladded (5/8"-11/16" [16-17])	96	96	114	114	149	149
							Net Add \$		
POWDER All Custom powder coated orders will include a net charge per purchase order							200		

- 3 Standard or Non-Standard Fabricated; lead time up to 3 business days.
- SO Special Fabricated/Finish or Special Order; lead time up to 5 weeks.

NOTES



- 3-5/8" SQ End Cap available Select Service in 101, 109, and 619; 4" SQ End Cap available in 101 and 619.
- End caps not available in true stainless steel. 619/618 Satin/Polished Nickel end caps supplied when 700/701 finish rails are ordered.

DRS Sidelite Rail Shim				List \$		
	925.134	Ea.	Stacking Glass Shim (no finish required)			2
				Rail	100	109
Saddles and Thresholds					3	3
	925.050	Ft.	Saddle 1/8" Head Typical	3-5/8"-10"	8	8
	934.135	Ft.	Saddle 1/8" Head Typical	2-1/2"	8	8
	925.049	Ft.	Saddle 1/4"	3-5/8"-10"	8	8
	934.136	Ft.	Saddle 1/4"	2-1/2"	8	8
	925.049	Ft.	Saddle 3/4"	3-5/8"-10"	8	8
	934.140	Ft.	Saddle 3/4"	2-1/2"	8	8
	925.051	Ft.	Saddle 3/8"	3-5/8"-10"	8	8
	934.137	Ft.	Saddle 3/8"	2-1/2"	8	8

DRS Rails, Channels & Accessories
Patch Fittings & Designer Pivots
Offset Hung Patch Fittings
Headers & Accessories
Closers & Hardware
Locksets
Pulls & Handles
Sliding Systems
MANET
Panic Hardware

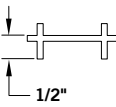
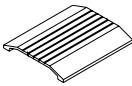
Glazing and Dri-Fit® U-Channels and Sidelite Accessories



				Rail	100	109
Saddles and Thresholds					3	3
	925.051	Ft.	Saddle 1/2"	3-5/8"–10"	8	8
	934.138	Ft.	Saddle 1/2"	2-1/2"	8	8
	925.058	Ft.	1/2" x 4" Threshold Available @ 16' Length	—	15	—

			Standard Finishes \$	Custom Finishes \$
Ref. #	U/M	Description	103	199/399
Glazing U-Channel			(S0)	(Q)
	925.059	Ft. 1" x 1" U-Channel bright silver anodized	7	26
	925.060	Ft. 1" x 2" U-Channel bright silver anodized	10	30



			Standard Finishes \$				Custom Finishes \$		
Ref. #	U/M	Description	101/108	109	113	503/599/600/601	700/701	199/399	299
			3	(S0)	3	(S0)	3	(Q)	(Q)

Note: Dri-Fit® gasket shipped installed for cut to length orders; shipped loose for full length orders.

Dri-Fit® U-Channel for 3/8" and 1/2" Glass

	925.071	Ft. 1" x 1" Dri-Fit®	11	15	15		32	
		Ln. Anodized (Gasket Included)	88	139	139		340	
	225.373	Ft. Cladded (Gasket Included)				39	23	48
		Ln.				351	239	445
	925.072	Ft. 1" x 1-3/4" Dri-Fit®	13	16	16		34	
		Ln. Anodized (Gasket Included)	113	151	151		365	
	225.374	Ft. Cladded (Gasket Included)				47	29	59
		Ln.				435	315	550







Dri-Fit® Channel for 5/8" and 3/4" Glass

	925.371	Ft. 1-1/4" x 1" Dri-Fit®	12	13			34	
		Ln. Anodized (Gasket Included)	103	126			365	
	225.371	Ft. Cladded (Gasket Included)				40	23	50
		Ln.				361	239	466
	925.372	Ft. 1-1/4" x 1-3/4" Dri-Fit®	13	15			35	
		Ln. Anodized (Gasket Included)	113	139			378	
	225.372	Ft. Cladded (Gasket Included)				47	28	59
		Ln.				435	302	550

NOTE

- Maximum length for Dri-Fit® U-Channel is 148" (3759) for anodized finishes (minimum useable length of 144"); 144" (3658) for stainless steel, and 120" (3 m) for brass or bronze finish before requiring splice/joint.
- Gasket shipped loose with full lengths unless otherwise requested (prep charge).
- Full lengths of 925.071, 925.072, 925.447, and 925.448 in 113 finish are 144" with gasket shipped loose.

Glazing and Dri-Fit® U-Channels and Sidelite Accessories

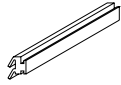
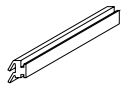
		Standard Finishes \$					Custom Finishes \$		
		101/108	109	113	503/599/600/601	700/701	199/399	299	
Ref. #	U/M Description	3	SO	3			Q	Q	
Dri-Fit® Channel for 3/8" and 1/2" Glass with mounting holes pre-drilled									
	925.447 Ln. 1" x 1" Dri-Fit® Anodized (Gasket Included; Shipped Loose)	142	147	201	—	—	343	—	
	925.448 Ln. 1" x 1-3/4" Dri-Fit® Anodized (Gasket Included; Shipped Loose)	162	169	222	—	—	414	—	
		Standard Finishes \$					Custom Finishes \$		
		101/108	109	113			199/399		
Ref. #	U/M Description	3	SO	SO			Q		
Dri-Fit® Channel for 5/8" and 3/4" Glass with mounting holes pre-drilled									
	925.445 Ln. 1-1/4" x 1" Dri-Fit® Anodized (Gasket Included; Shipped Loose)	142	147	181	—	—	343	—	
	925.446 Ln. 1-1/4" x 1-3/4" Dri-Fit® Anodized (Gasket Included; Shipped Loose)	162	169	217	—	—	414	—	
		803 (Black)	807 (Grey)						
	925.121 Ea. End cap for both 1" x 1" and 1" x 1-3/4"	5 ①	5 ①	—	—	—	—	—	
	925.122 Ea. End cap for both 1-1/4" x 1" and 1-1/4" x 1-3/4"	5 SO	5 SO	—	—	—	—	—	
Dri-Fit® Channel Gasket (Gasket is included in Dri-Fit® U-Channel and requires 2-1 length vs. U-channel)									
									List \$
									3
	925.075 Ft. Gasket for Vertical Stiles, 3/8" (10) and 5/8" (16) Glass								3
	925.148 Ft. Gasket for DRS, Dri-Fit® Sidelite Rails, and Dri-fit® U-Channel, 3/8" (10) and 5/8" (16) Glass NOTE: Gasket shipped loose with stock length Dri-Fit® Sidelite Rails and Dri-Fit® U-Channel.								1
	925.076 Ft. Gasket for Vertical Stiles, 1/2" (12) and 3/4" (19) Glass								3
	925.147 Ft. Gasket for DRS, Dri-Fit® Sidelite Rails, and Dri-Fit® U-Channel, 1/2" (12) and 3/4" (19) Glass NOTE: Gasket shipped loose with stock length Dri-Fit® Sidelite Rails and Dri-Fit® U-Channel.								1
GASKET	Install gasket charge per each stock length Dri-Fit® U-channel								39
MITER	Miter cut charge								65
									Net Add \$
POWDER	All Custom powder coated orders will include a net charge per purchase order								200













- ① Non-Fabricated item, ships in 1 business day.
- ③ Standard or Non-Standard Fabricated; lead time up to 3 business days.
- SO Special Fabricated/Finish or Special Order; lead time up to 5 weeks.

NOTES

- Must specify length when ordering. dormakaba will cut to specified size, priced per foot (Ft.) only.
- Maximum length for extrusion is 144" (3.7 m) before requiring splice/joint; 120" (3 m) for brass or bronze finish.

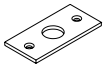
DRS Rails, Channels & Accessories
Patch Fittings & Designer Pivots
Offset Hung Patch Fittings
Headers & Accessories
Closers & Hardware
Locksets
Pulls & Handles
Sliding Systems
MANET
Panic Hardware

DRS Accessories

Model	Ref. #	U/M	Description	List \$				
DRS Rail Locks								
	925.019	Ea.	Brass Lock 1-9/16" 5/8" Throw					39 ^①
	925.119	Ea.	Bottom Rail Brass Door Lock 1-9/16" (7/8" long throw fully retracted projects 1/4" below lock base)					54 ^①
	925.018	Ea.	Brass Lock 1-15/16" 5/8" Throw. Not for use with DRS Rails. Requires 1-15/16" lock height clearance in rail.					41 ^①
	934.018	Ea.	Brass Door Lock, 1-9/16" (5/8" Throw) Modified for 2-1/2" Rail Only					77 ^③
	934.017	Ea.	Bottom Rail Brass Door Lock 1-9/16" (7/8" long throw fully retracted projects 1/4" below lock base) Modified for 2-1/2" Rail Only					90 ^③
	925.021	Ea.	Extended Lock Bolt 7/8" Throw					16 ^①
	925.022	Ea.	Square Lock Bolt					6 ^{SO}
				101	109	500/501	503/599	600/601
	932.033	Ea.	Dust Proof Strike Overall Length 1-1/2"	30 ^①	30 ^①	30 ^①	30 ^{SO}	30 ^{SO}
	925.140	Ea.	Strike Plate	15 ^①	15 ^①	15 ^①	15 ^{SO}	15 ^{SO}
							Finishes \$	
							101/108	500/501
Cylinders							^①	^①
	225.999	Ea.	Mortise cylinder for DRS lock, with split ring. (If cylinder requires Master Keying, lead time is Special Order ^{SO})				21	21
	225.998	Ea.	Mortise Thumb-Turn for DRS Lock, with split ring				21	21
	225.994	Ea.	Mortise Dummy (blank) Cylinder for DRS Lock, with split ring				15	15

- ① Non-Fabricated item, ships in 1 business day.
- ③ Standard or Non-Standard Fabricated; lead time up to 3 business days.
- SO Special Fabricated/Finish or Special Order; lead time up to 5 weeks.

NOTE: Cylinders supplied as Keyed Different (KD). For the Cylinder and Keying Options such as KA, see **Cylinder Types, Keying Options, and Keyways**

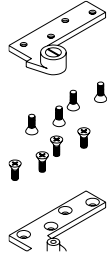
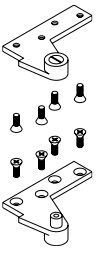
BTS Hardware – Offset Arms and Pivots				314 (Primer)	101	108/109	500/501	503/599	600/601/602
	929.034	Ea.	3/4" Offset Top Pivot (75120) (Specify Hand)	121 ^(SO)	121 ⁽¹⁾	121 ^(SO)	121 ⁽¹⁾	121 ^(SO)	121 ^(SO)
	929.019	Ea.	1-1/2" Offset Top Pivot (15120) (Specify Hand)	195 ^(SO)	195 ^(SO)	195 ^(SO)	195 ⁽¹⁾	195 ^(SO)	195 ^(SO)

				Finishes \$			
Model	Ref. #	U/M	Description	101	108/109	503/599	500/501

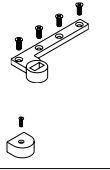
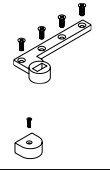
BTS Hardware – Offset Arms and Pivots				(1)	(1)	(SO)	(1)
	229.001 229.002	RH Ea. LH Ea.	75323 3/4" Offset Bottom Arm, BTS	82	82	82	82
	229.011 229.012	RH Ea. LH Ea.	15323 1-1/2" Offset Bottom Arm, BTS	199	199	199	199

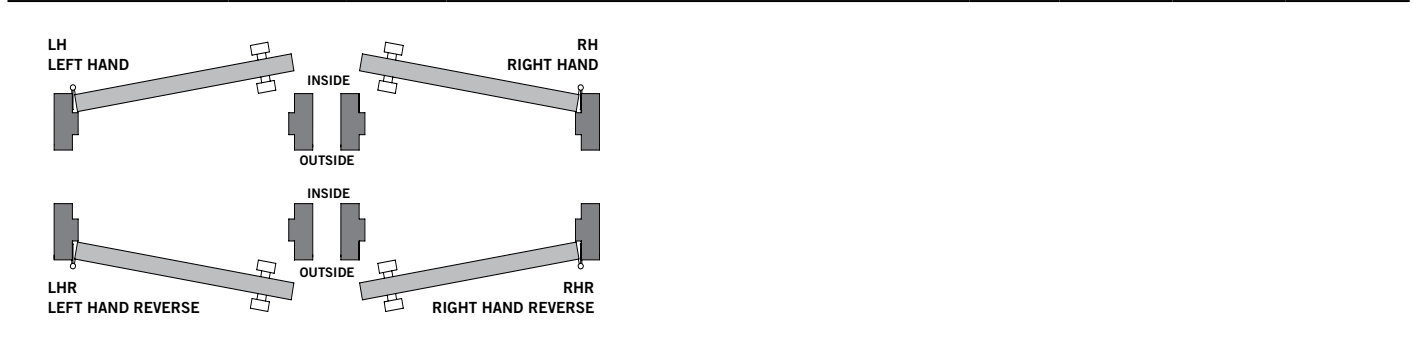

DRS Rails, Channels & Accessories
 Patch Fittings & Designer Pivots
 Offset Hung Patch Fittings
 Headers & Accessories
 Closers & Hardware
 Locksets
 Pulls & Handles
 Sliding Systems
 MANET
 Panic Hardware

RTS88 Hardware — Arms and Pivots

①

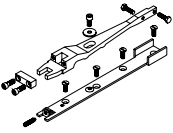
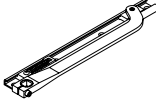
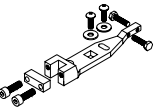
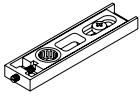
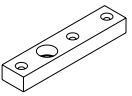
	228.001	Ea.	8534 7/8" End Load Top Arm, RTS	64
	928.009	Ea.	8812 Slide Arm for RTS Independent Hung Doors	87
	928.001	Ea.	8836S 7/8" End Load Top Arm, Glass Door Shoe, RTS	93
	927.062	Ea.	8062LOWER CH Top Walking Beam Pivot, Rail Portion Only	29
	927.050	Ea.	HD8062LOWER Heavy-Duty CH Walking Beam Top Pivot, Rail Portion Only	95



DRS Options

Option	Description	List \$
HDWPREP	Prep and installation of non-standard dormakaba hardware (i.e., offset pivots, arms, etc.) in DRS rail	80
CMP HDWP	Competitors hardware prep (charge may be reviewed based on complexity)	95
CMP HDWI	Competitors hardware preparation and installation	160
CMP SHEAR	Competitors Electro-Magnetic Shear Lock or Magnetic Lock Armature prep	300
		Net Add \$
POWDER	All Custom powder coated orders will include a net charge per purchase order.	200

① Non-Fabricated item, ships in 1 business day.

⑧ Special Fabricated/Finish or Special Order; lead time up to 5 weeks.

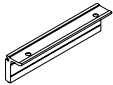
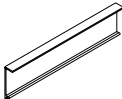
Mechanical Channel and Endcap

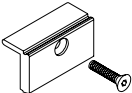
Model	Ref. #	U/M	Description	Standard Finishes \$	Custom Finishes \$
Mechanical Channel Base (No Glass Fabrication Required)				100	
	807.051	Ft.	3/8" (10) Base mechanical channel (157" [4 m] max. length) and clamps	69 ³	
	807.055	Ft.	1/2" (12) Base mechanical channel (157" [4 m] max. length) and clamps	69 ³	
	807.057	Ft.	5/8" (15) Base mechanical channel (157" [4 m] max. length) and clamps	71 ^(SO)	
	807.059	Ft.	3/4" (19) Base mechanical channel (157" [4 m] max. length) and clamps	71 ³	
				101	108*/109
Mechanical Channel Cover (No Glass Fabrication Required)				3	3 / (SO)
	807.053	Ft.	Clip-On Cover 157" (4 m) max. length	8	13* —
	207.153	Ft.	Clip-On Cover 157" (4 m) max. length	—	— 17
				199/399	299
				Q	Q
				—	—
				—	29
				—	29
*108, 199, 299, 399 cover max. length is 118" (3 m).					
Mechanical Channel Endcap					
	807.007	Ea.	Endcap 3/8"-1/2" (10-12)	19 ^(SO)	
	807.065	Ea.	Endcap 19/32"-3/4" (15-19)	24 ^(SO)	
Mechanical Channel Clamps				3	
	807.004	Ea.	3/8" (10)	21	
	807.085	Ea.	1/2" (12)	21	
	807.089	Ea.	3/4" (19)	27	
				^(SO)	
	807.087	Ea.	5/8" (15)	27	
					Net Add \$
POWDER	All Custom powder coated orders will include a net charge per purchase order.				200

³ Standard or Non-Standard Fabricated; lead time up to 3 business days.
^(SO) Special Fabricated/Finish or Special Order; lead time up to 5 weeks.

NOTES

- Base mechanical channel includes clamp brackets, first foot pulls two clamps and each remaining foot pulls one clamp per foot.
- Mechanical channel is not recommended for use with laminated glass.
- Max. length of mechanical channel cover in 108, 199, 299, 399 finish is 118" (3 m).

DRS Rails, Channels & Accessories
 Patch Fittings & Designer Pivots
 Offset Hung Patch Fittings
 Headers & Accessories
 Closers & Hardware
 Locksets
 Pulls & Handles
 Sliding Systems
 MANET
 Panic Hardware

Polycarbonate Glazing Accessories

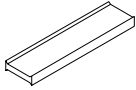
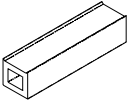
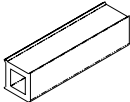
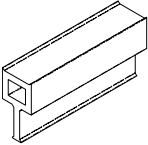
Model	Ref. #	U/M	Description	List \$
Bowtie				3
	757.026	Ft.	1/2" Polycarbonate Bowtie	4
	757.020	Ft.	5/8" Polycarbonate Bowtie	5
	757.023	Ft.	3/4" Polycarbonate Bowtie	6
Abutment				
	757.015	Ft.	1/2" Polycarbonate Abutment	6
	757.021	Ft.	5/8" Polycarbonate Abutment	7
	757.024	Ft.	3/4" Polycarbonate Abutment	8
90-Degree				
	757.017	Ft.	1/2" Polycarbonate, 90-Degree	6
	757.019	Ft.	5/8" Polycarbonate, 90-Degree	8
	757.018	Ft.	3/4" Polycarbonate, 90-Degree	10
3-Way				
	757.016	Ft.	1/2" Polycarbonate, 3-Way	9
	757.022	Ft.	5/8" Polycarbonate, 3-Way	10
	757.025	Ft.	3/4" Polycarbonate, 3-Way	11

Center Hung Patch Fittings and Designer Pivots

	Select Service	40
MUNDUS Center Hung Patch Fittings	Ordering Guide	42
	MUNDUS Premium & Comfort Patch Fittings/Transom & Sidelite Patch Fittings	43
	MUNDUS Premium Patch Fittings/Transom & Sidelite Patch Fittings	45
	Replacement Parts	48
	Accessories	49
Universal Center Hung Patch Fittings	Universal Center Hung Patch Fittings/Transom, Sidelite & Fin Patch Fittings	52
	Connectors	56
	Accessories	59
	Options	60
	Standard Sets	62
Designer Pivots	TENSOR Designer Pivot/Hinge	63
	BEYOND Pinch-Free Pivot	64

DRS Rails,
Channels &
Accessories

Patch Fittings
& Designer
Pivots

Offset
Hung Patch
Fittings

Headers &
Accessories

Closers &
Hardware

Locksets

Pulls &
Handles

Sliding
Systems

MANET

Panic
Hardware

Select Service Quick Ship — Patch Fittings and Designer Pivots

Universal patch fittings are the only Select Service fittings available at this time.

Select service should be used for small quantities of popular dormakaba products that require shipment within 24 hours. The program includes patch fittings, DRS rails, headers, concealed closers and pivots, and pulls and handles. Warehouses have been set up in the east and west for faster delivery nationwide. (Customer responsible for shipping costs FOB.)

Subject to Availability

Next Business Day Service (Shipment when Purchase Order is received prior to 4:00 PM EST).

Examples: dormakaba receives P.O. at 3:59 PM on Monday, order will ship by close of business on Tuesday. dormakaba receives P.O. at 3:59 PM on Friday, order will ship by close of business on the following Monday.

Notes:

- Standard freight and discount schedules and terms of sale apply. Please refer to the current price list for full details.
- dormakaba reserves the right to limit quantities or decline an order if the credit status of the buyer is not satisfactory to dormakaba.
- Orders cannot be cancelled.
- Select Service Quick Ship available only in the United States.
- All prices are in U.S. dollars.
- Products and prices are subject to change without notice.
- Limited quantities available.

Key

N "New" to Select Service, Available in East and West Coast Warehouse

■ Available in East and West Coast Warehouse

E Available only in East Coast Warehouse

W Available only in West Coast Warehouse

Patch Fittings and Designer Pivots

3/8" (10) to 1/2" (12) Glass

2-3/4" (70) pivot location

PN #	Warehouse	Product	Description	Location	Glass	Finish	List \$
833.110.101.SS	■	PT20	Use with PT21 WBP	Top patch	1/2" (12)	101	65
833.110.108.SS	□	PT20	Use with PT21 WBP	Top patch	1/2" (12)	108	79
833.110.700.SS	■	PT20	Use with PT21 WBP	Top patch	1/2" (12)	700	89
833.110.701.SS	□	PT20	Use with PT21 WBP	Top patch	1/2" (12)	701	89
833.112.101.SS	■	PT22	Use with RTS	Top patch	1/2" (12)	101	74
833.112.108.SS	□	PT22	Use with RTS	Top patch	1/2" (12)	108	89
833.112.700.SS	■	PT22	Use with RTS	Top patch	1/2" (12)	700	96
833.112.701.SS	□	PT22	Use with RTS	Top patch	1/2" (12)	701	96
833.100.101.SS	■	PT10	Use with BTS, 7471K, or 355.5	Bottom patch	1/2" (12)	101	70
833.100.108.SS	□	PT10	Use with BTS, 7471K, or 355.5	Bottom patch	1/2" (12)	108	83
833.100.700.SS	■	PT10	Use with BTS, 7471K, or 355.5	Bottom patch	1/2" (12)	700	93
833.100.701.SS	□	PT10	Use with BTS, 7471K, or 355.5	Bottom patch	1/2" (12)	701	93
833.111.101.SS	■	PT20	Use with PT21 WBP	Top patch	3/4" (19)	101	110
833.111.108.SS	□	PT20	Use with PT21 WBP	Top patch	3/4" (19)	108	132
833.111.700.SS	■	PT20	Use with PT21 WBP	Top patch	3/4" (19)	700	136
833.111.701.SS	□	PT20	Use with PT21 WBP	Top patch	3/4" (19)	701	136
833.113.101.SS	■	PT22	Use with RTS	Top patch	3/4" (19)	101	118
833.113.108.SS	□	PT22	Use with RTS	Top patch	1/2" (12)	108	141
833.113.700.SS	■	PT22	Use with RTS	Top patch	1/2" (12)	700	143
833.113.701.SS	□	PT22	Use with RTS	Top patch	1/2" (12)	701	143
833.101.101.SS	■	PT10	Use with BTS, 7471K, or 355.5	Bottom patch	3/4" (19)	101	113
833.101.108.SS	□	PT10	Use with BTS, 7471K, or 355.5	Bottom patch	3/4" (19)	108	136
833.101.700.SS	■	PT10	Use with BTS, 7471K, or 355.5	Bottom patch	3/4" (19)	700	139
833.101.701.SS	□	PT10	Use with BTS, 7471K, or 355.5	Bottom patch	3/4" (19)	701	139

DRS Rails,
Channels &
Accessories

Patch Fittings
& Designer
Pivots

Offset
Hung Patch
Fittings

Headers &
Accessories

Closers &
Hardware

Locksets

Pulls &
Handles

Sliding
Systems

MANET

Panic
Hardware

MUNDUS Patch Fittings

Ordering Guide

Product		Fitting		Insert	
MUNDUS		PT10	Bottom Patch	Blank	BLANK
		PT20	Top Patch	Stop	STOP
		PT30	Transom Patch	Pivot	PIVOT
		PT40	Transom & Sidelite Patch		
		PT41	Transom & Sidelite Patch		
		PT60	Premium Connector		
		PT61	Premium Connector		
		PT70	Premium Transom Connector		
MUNDUS	PT10	5/16 - 1/2	630		
	5/16"-1/2" (8-12) Glass	5/16 - 1/2	628	Clear Anodized	
	9/16" (14) Laminate	9/16	710	Dark Bronze	
	5/8"-3/4" (15-19) Glass	5/8 - 3/4	711	Black Anodized	
	11/16" (17) Laminate	11/16	728	Satin Brass	
	13/16"-7/8" (19-22) Laminate	13/16 - 7/8	630	Satin Stainless Steel	
			629	Polished Stainless Steel	
			880	Black Glass	
		Glass Thickness		Standard Finish	
				199	Custom Anodized (Specify)
				299	Custom Cladding (Specify)
				399	Custom Coated (Specify)
					Custom Finish^{1, 2, 3}

¹ For custom 199, 299, or 399 finishes, there may be minimum order quantities based on minimum lot charges. Lead time will be extended.

² dormakaba reserves the right to refuse Custom Finishes.

³ All Custom Finishes require customer sign-off/approval of color chip.

MUNDUS Premium & Comfort Patch Fittings

2-3/4" (70) Pivot Center Line, Center Hung

Type A, BP, and F Doors

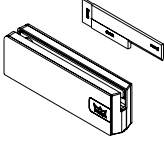
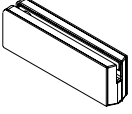
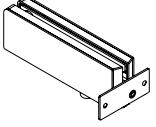
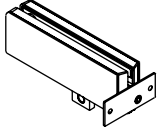
Model	Ref. #	U/M	Description	Standard Finishes \$					Custom Finishes \$	
				628 (101*)	710/711 (108/109*)	728 (599*)	630/629 (700/701*)	880	199/399	299
Bottom Patch PT10 (BTS, 7471K, 355.5, or 355.6)				3	3	SO	3	SO	SO	SO
	838.100	Ea.	5/16" – 1/2" (8–12)	113	113	157	183	308	191	308
	842.101	Ea.	9/16" (14) TLG	141	141	197	229	354	239	385
	842.102	Ea.	5/8" & 3/4" (15 & 19)	177	177	245	286	396	283	424
	842.104	Ea.	11/16" (17) TLG	208	208	288	336	436	345	518
	842.103	Ea.	13/16" & 7/8" (19 & 22) TLG	239	239	332	386	444	399	600
Top Patch PT20 (PT21M, PT24M, PT25M, or MUNDUS PT30, 40, 41 with Pivot)										
	838.200	Ea.	5/16" – 1/2" (8–12)	113	113	157	183	308	191	308
	842.201	Ea.	9/16" (14) TLG	141	141	197	229	354	239	385
	842.202	Ea.	5/8" & 3/4" (15 & 19)	177	177	245	286	396	283	424
	842.204	Ea.	11/16" (17) TLG	208	208	288	336	436	345	518
	842.203	Ea.	13/16" & 7/8" (19 & 22) TLG	239	239	332	386	444	399	600
Transom Patch PT30 with Pivot										
	838.300	Ea.	5/16" – 1/2" (8–12)	139	139	179	206	328	218	328
	842.301	Ea.	9/16" (14) TLG	175	175	214	248	376	274	410
	842.302	Ea.	5/8" & 3/4" (15 & 19)	227	227	268	279	422	312	468
	842.310	Ea.	11/16" (17) TLG	266	266	315	335	464	374	563
	842.309	Ea.	13/16" & 7/8" (19 & 22) TLG	306	306	362	387	472	433	649
Transom Patch PT30 with Stop										
	838.303	Ea.	5/16" – 1/2" (8–12)	139	139	179	206	328	218	328
	842.303	Ea.	9/16" (14) TLG	175	175	214	248	376	274	410
	842.304	Ea.	5/8" & 3/4" (15 & 19)	227	227	268	279	422	312	468
	842.311	Ea.	11/16" (17) TLG	266	266	315	335	464	374	563
	842.305	Ea.	13/16" & 7/8" (19 & 22) TLG	306	306	362	387	472	433	649

Note: PT30 comes with the wall plate (default) unless the Wall Anchor or Threaded Rod Anchor is requested.

Patch Fitting Options	Net Add \$
POWDER All Custom powder coated orders will include a net charge per purchase order.	200

* Old DORMA finish code

3 Standard or Non-Standard Fabricated; lead time up to 3 business days.
 SO Special Fabricated/Finish or Special Order; lead time up to 5 weeks.

NOTES:

- MUNDUS Premium reference numbers start with 842.
- MUNDUS Comfort reference numbers start with 838.
- Replacement part numbers do not correspond to "Premium" or "Comfort".
- All measurements are shown in inches (mm); for example 3/8" (10)
- See pages 78 and 79 for MUNDUS Header options

DRS Rails, Channels & Accessories
 Patch Fittings & Designer Pivots
 Offset Hung Patch Fittings
 Headers & Accessories
 Closers & Hardware
 Locksets
 Pulls & Handles
 Sliding Systems
 MANET
 Panic Hardware

MUNDUS Premium & Comfort Patch Fittings, Complete

2-3/4" (70) Pivot Center Line, Center Hung

Type A, BP, and F Doors

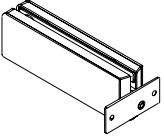
Model	Ref. #	U/M	Description	Standard Finishes \$				Custom Finishes \$		
				628 (101*)	710/711 (108/109*)	728 (599*)	630/629 (700/701*)	880	199/399	299
Transom Patch PT30 with Blank				③	③	SO	③	SO	SO	SO
	838.306	Ea.	5/16"–1/2" (8–12)	139	139	179	206	328	218	328
	842.306	Ea.	9/16" (14) TLG	175	175	214	248	376	274	410
	842.307	Ea.	5/8" & 3/4" (15 & 19)	227	227	268	279	422	312	468
	842.312	Ea.	11/16" (17) TLG	266	266	315	335	464	374	563
	842.308	Ea.	13/16" & 7/8" (19 & 22) TLG	306	306	362	387	472	433	649

Note: PT30 comes with the wall plate (default) unless the Wall Anchor or Threaded Rod Anchor is requested.

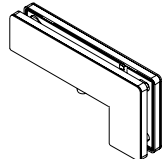
Transom/Sidelite Patch Fitting PT40 with Pivot				SO	SO	SO	SO	SO	SO	SO
	838.400	Ea.	5/16"–1/2" (8–12)	189	189	219	259	409	271	409
	842.401	Ea.	9/16" (14) TLG	237	237	275	349	470	339	511
	842.402	Ea.	5/8" & 3/4" (15 & 19)	308	308	343	391	517	368	552
	842.440	Ea.	11/16" (17) TLG	362	362	394	410	569	459	688
	842.409	Ea.	13/16" & 7/8" (19 & 22) TLG	415	415	428	466	579	521	782

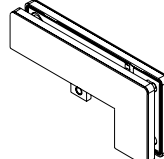
Transom/Sidelite Patch Fitting PT40 with Stop										
	838.403	Ea.	5/16"–1/2" (8–12)	189	189	219	259	409	271	409
	842.403	Ea.	9/16" (14) TLG	237	237	275	349	470	339	511
	842.404	Ea.	5/8" & 3/4" (15 & 19)	308	308	343	391	517	368	552
	842.441	Ea.	11/16" (17) TLG	362	362	394	410	569	459	688
	842.405	Ea.	13/16" & 7/8" (19 & 22) TLG	415	415	428	466	579	521	782

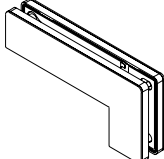
Transom/Sidelite Patch Fitting PT40 with Blank										
	838.406	Ea.	5/16"–1/2" (8–12)	189	189	219	259	409	271	409
	842.406	Ea.	9/16" (14) TLG	237	237	275	349	470	339	511
	842.407	Ea.	5/8" & 3/4" (15 & 19)	308	308	343	391	517	368	552
	842.442	Ea.	11/16" (17) TLG	362	362	394	410	569	459	688
	842.408	Ea.	13/16" & 7/8" (19 & 22) TLG	415	415	428	466	579	521	782

Patch Fitting Options			Net Add \$
POWDER	All Custom powder coated orders will include a net charge per purchase order.		200

* Old DORMA finish code

③ Standard or Non-Standard Fabricated; lead time up to 3 business days.

SO Special Fabricated/Finish or Special Order; lead time up to 5 weeks.

NOTES:

- MUNDUS Premium reference numbers start with 842.
- MUNDUS Comfort reference numbers start with 838.
- Replacement part numbers do not correspond to "Premium" or "Comfort".
- Epoxy and applicator tips are included in 9/16" (14), 11/16" (17), and 13/16"–7/8" (19–22) fittings.
- All measurements are shown in inches (mm); for example 3/8" (10).

MUNDUS Premium Patch Fittings, Complete

2-3/4" (70) Pivot Center Line, Center Hung

Type A, BP, and F Doors

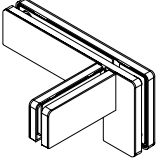
Model	Ref. #	U/M	Description	Standard Finishes \$					Custom Finishes \$	
				628 (101*)	710/711 (108/109*)	728** (599*)	630/629 (700/701*)	880	199/399	299
				(SO)	(SO)	(SO)	(SO)	(SO)	(SO)	(SO)
Transom/Sidelite/Fin Patch Fitting PT41 with Pivot (319.3), Left										
	842.410	Ea.	5/16" to 1/2" (8-12)	360	414	—	360	—	499	—
	842.411	Ea.	9/16" (14) TLG	396	450	—	396	—	536	—
	842.412	Ea.	5/8" & 3/4" (15-19)	447	515	—	447	—	588	—
	842.443	Ea.	11/16" (17) TLG	473	541	—	473	—	614	—
	842.472	Ea.	13/16" & 7/8" (19-22) TLG	494	562	—	494	—	634	—
Transom/Sidelite/Fin Patch Fitting PT41 with Stop (355.42), Left										
	842.413	Ea.	5/16" to 1/2" (8-12)	360	414	—	360	—	499	—
	842.414	Ea.	9/16" (14) TLG	396	450	—	396	—	536	—
	842.415	Ea.	5/8" & 3/4" (15-19)	447	515	—	447	—	588	—
	842.445	Ea.	11/16" (17) TLG	473	541	—	473	—	614	—
	842.473	Ea.	13/16" & 7/8" (19-22) TLG	494	562	—	494	—	634	—
Transom/Sidelite/Fin Patch Fitting PT41 with Blank (355.43), Left										
	842.416	Ea.	5/16" to 1/2" (8-12)	360	414	—	360	—	499	—
	842.417	Ea.	9/16" (14) TLG	396	450	—	396	—	536	—
	842.418	Ea.	5/8" & 3/4" (15-19)	447	515	—	447	—	588	—
	842.447	Ea.	11/16" (17) TLG	473	541	—	473	—	614	—
	842.419	Ea.	13/16" & 7/8" (19-22) TLG	494	562	—	494	—	634	—
Transom/Sidelite/Fin Patch Fitting PT41 with Pivot (319.3), Right										
	842.420	Ea.	5/16" to 1/2" (8-12)	360	414	—	360	—	499	—
	842.421	Ea.	9/16" (14) TLG	396	450	—	396	—	536	—
	842.422	Ea.	5/8" & 3/4" (15-19)	447	515	—	447	—	588	—
	842.444	Ea.	11/16" (17) TLG	473	541	—	473	—	614	—
	842.474	Ea.	13/16" & 7/8" (19-22) TLG	494	562	—	494	—	634	—
Patch Fitting Options										
POWDER	All Custom powder coated orders will include a net charge per purchase order.									
	200									

* Old DORMA finish code
 ** 8 weeks lead time for finish 728.

(SO) Special Fabricated/Finish or Special Order; lead time up to 5 weeks.

NOTES:

- MUNDUS Premium reference numbers start with 842.
- MUNDUS Comfort reference numbers start with 838.
- Replacement part numbers do not correspond to "Premium" or "Comfort".
- Epoxy and applicator tips are included in 9/16" (14), 11/16" (17), and 13/16"–7/8" (19–22) fittings.
- All measurements are shown in inches (mm); for example 3/8" (10).

DRS Rails, Channels & Accessories
 Patch Fittings & Designer Pivots
 Offset Hung Patch Fittings
 Headers & Accessories
 Closers & Hardware
 Locksets
 Pulls & Handles
 Sliding Systems
 MANET
 Panic Hardware

MUNDUS Premium Patch Fittings, Complete

2-3/4" (70) Pivot Center Line, Center Hung

Type A, BP, and F Doors

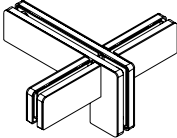
Model	Ref. #	U/M	Description	Standard Finishes \$				Custom Finishes \$		
				628 (101*)	710/711 (108/109*)	728** (599*)	630/629 (700/701*)	880	199/399	299
				(SO)	(SO)	(SO)	(SO)	(SO)	(SO)	(SO)
Transom/Sidelite/Fin Patch Fitting PT41 with Stop (355.42), Right										
	842.423	Ea.	5/16" to 1/2" (8-12)	360	414	—	360	—	499	—
	842.424	Ea.	9/16" (14) TLG	396	450	—	396	—	536	—
	842.425	Ea.	5/8" & 3/4" (15-19)	447	515	—	447	—	588	—
	842.446	Ea.	11/16" (17) TLG	473	541	—	473	—	614	—
	842.475	Ea.	13/16" & 7/8" (19-22) TLG	494	562	—	494	—	634	—
Transom/Sidelite/Fin Patch Fitting PT41 with Blank (355.43), Right										
	842.426	Ea.	5/16" to 1/2" (8-12)	360	414	—	360	—	499	—
	842.427	Ea.	9/16" (14) TLG	396	450	—	396	—	536	—
	842.428	Ea.	5/8" & 3/4" (15-19)	447	515	—	447	—	588	—
	842.449	Ea.	11/16" (17) TLG	473	541	—	473	—	614	—
	842.429	Ea.	13/16" & 7/8" (19-22) TLG	494	562	—	494	—	634	—
Transom/Sidelite/Fin Patch Fitting PT41 with Pivot (319.3), Left & Right										
	842.430	Ea.	5/16" to 1/2" (8-12)	576	664	—	576	—	840	—
	842.431	Ea.	9/16" (14) TLG	622	708	—	622	—	886	—
	842.432	Ea.	5/8" & 3/4" (15-19)	671	771	—	671	—	929	—
	842.450	Ea.	11/16" (17) TLG	700	801	—	700	—	959	—
	842.476	Ea.	13/16" & 7/8" (19-22) TLG	729	830	—	729	—	987	—
Transom/Sidelite/Fin Patch Fitting PT41 with Stop (355.42), Left & Right										
	842.433	Ea.	5/16" to 1/2" (8-12)	576	664	—	576	—	840	—
	842.434	Ea.	9/16" (14) TLG	622	708	—	622	—	886	—
	842.435	Ea.	5/8" & 3/4" (15-19)	671	771	—	671	—	929	—
	842.451	Ea.	11/16" (17) TLG	700	801	—	700	—	959	—
	842.477	Ea.	13/16" & 7/8" (19-22) TLG	729	830	—	729	—	987	—
Transom/Sidelite/Fin Patch Fitting PT41 with Blank (355.43), Left & Right										
	842.436	Ea.	5/16" to 1/2" (8-12)	576	664	—	576	—	840	—
	842.437	Ea.	9/16" (14) TLG	622	708	—	622	—	886	—
	842.438	Ea.	5/8" & 3/4" (15-19)	671	771	—	671	—	929	—
	842.452	Ea.	11/16" (17) TLG	700	801	—	700	—	959	—
	842.439	Ea.	13/16" & 7/8" (19-22) TLG	729	830	—	729	—	987	—

Patch Fitting Options

POWDER	All Custom powder coated orders will include a net charge per purchase order.	Net Add \$ 200
---------------	--	--------------------------

NOTES:

- MUNDUS Premium reference numbers start with 842.
- MUNDUS Comfort reference numbers start with 838.
- Replacement part numbers do not correspond to "Premium" or "Comfort".
- Epoxy and applicator tips are included in 9/16" (14), 11/16" (17), and 13/16" – 7/8" (19 – 22) fittings.
- All measurements are shown in inches (mm); for example 3/8" (10).

* Old DORMA finish code
** 8 weeks lead time for finish **728**.

(SO) Special Fabricated/Finish or Special Order; lead time up to 5 weeks.

MUNDUS Premium Patch Fittings, Complete

2-3/4" (70) Pivot Center Line, Center Hung

Type A, BP, and F Doors

Model	Ref. #	U/M	Description	Standard Finishes \$					Custom Finishes \$	
				628 (101*)	710/711 (108/109*)	728** (599*)	630/629 (700/701*)	880	199/399	299
				(SO)	(SO)	(SO)	(SO)	(SO)	(SO)	(SO)
Transom/Sidelite Connector PT60 with 1 Stop, 2 Blanks										
	842.600	Ea.	5/16" to 1/2" (8-12)	137	157	317	137	259	200	—
	842.601	Ea.	9/16" (14) TLG	158	178	338	158	280	220	—
	842.602	Ea.	5/8" & 3/4" (15-19)	199	228	424	199	331	289	—
	842.606	Ea.	11/16" (17) TLG	219	249	445	219	352	310	—
	842.603	Ea.	13/16" & 7/8" (19-22) TLG	225	254	450	225	357	315	—
Transom/Sidelite/Fin Connector PT61 - Left										
	842.610	Ea.	5/16" to 1/2" (8-12)	285	328	—	285	—	416	—
	842.611	Ea.	9/16" (14) TLG	321	364	—	321	—	452	—
	842.612	Ea.	5/8" & 3/4" (15-19)	346	398	—	346	—	504	—
	842.607	Ea.	11/16" (17) TLG	372	424	—	372	—	530	—
	842.604	Ea.	13/16" & 7/8" (19-22) TLG	393	445	—	393	—	551	—
Transom/Sidelite/Fin Connector PT61 - Right										
	842.613	Ea.	5/16" to 1/2" (8-12)	285	328	—	285	—	416	—
	842.614	Ea.	9/16" (14) TLG	321	364	—	321	—	452	—
	842.615	Ea.	5/8" & 3/4" (15-19)	346	398	—	346	—	504	—
	842.608	Ea.	11/16" (17) TLG	372	424	—	372	—	530	—
	842.605	Ea.	13/16" & 7/8" (19-22) TLG	393	445	—	393	—	551	—
Transom/Sidelite/Fin Connector PT61 - Left & Right										
	842.616	Ea.	5/16" to 1/2" (8-12)	501	576	—	501	—	757	—
	842.617	Ea.	9/16" (14) TLG	547	622	—	547	—	803	—
	842.618	Ea.	5/8" & 3/4" (15-19)	569	654	—	569	—	844	—
	842.609	Ea.	11/16" (17) TLG	599	684	—	599	—	875	—
	842.619	Ea.	13/16" & 7/8" (19-22) TLG	628	713	—	628	—	904	—
Transom Connector PT70 with 2 Ea. Stops/Blanks										
	842.700	Ea.	5/16" to 1/2" (8-12)	126	145	236	126	248	183	—
	842.701	Ea.	9/16" (14) TLG	152	171	262	152	274	209	—
	842.702	Ea.	5/8" & 3/4" (15-19)	187	215	312	187	317	326	—
	842.704	Ea.	11/16" (17) TLG	203	231	328	203	333	341	—
	842.703	Ea.	13/16" & 7/8" (19-22) TLG	213	241	338	213	343	352	—

Patch Fitting Options

POWDER All Custom powder coated orders will include a **net charge** per purchase order. **Net Add \$** 200

- NOTES:**
- MUNDUS Premium reference numbers start with 842.
 - MUNDUS Comfort reference numbers start with 838.
 - Replacement part numbers do not correspond to "Premium" or "Comfort".
 - Epoxy and applicator tips are included in 9/16" (14), 11/16" (17), and 13/16"–7/8" (19–22) fittings.
 - All measurements are shown in inches (mm); for example 3/8" (10).

* Old DORMA finish code
 ** 8 weeks lead time for finish **728**.

(SO) Special Fabricated/Finish or Special Order; lead time up to 5 weeks.

DRS Rails, Channels & Accessories
 Patch Fittings & Designer Pivots
 Offset Hung Patch Fittings
 Headers & Accessories
 Closers & Hardware
 Locksets
 Pulls & Handles
 Sliding Systems
 MANET
 Panic Hardware

MUNDUS Premium & Comfort Patch Fittings

Replacement Parts

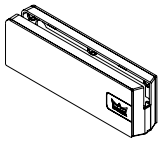
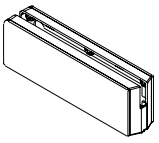
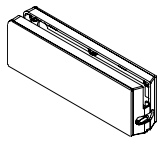
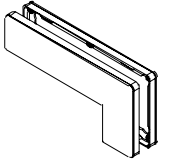
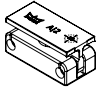
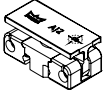
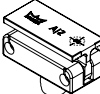



Model	Ref. #	U/M Description	Standard Finishes \$					Custom Finishes \$	
			628 (101*)	710/711 (108/109*)	728 (599*)	630/629 (700/701*)	880	199/399	299
Cover Patch Fittings			3	3	SO	3	SO	SO	SO
	842.199	Pr. Cover, patch fitting. Use with PT10 (branded)	52	—	—	64	192	—	—
	842.299	Pr. Cover, patch fitting. Use with PT10, PT20 (unbranded)	52	81	101	64	192	—	—
	842.399	Pr. Cover, patch fitting. Use with PT30	52	81	101	64	192	—	—
	842.499	Pr. Cover, patch fitting. Use with PT40	76	132	336	103	258	—	—
Patch Fitting Inserts									List \$
	842.800	Ea. Insert for PT10, 5/16"—1/2" (8—12). Use with BTS, 7417K, 355.5 or 355.6							56
	842.801	Ea. Insert for PT10, 9/16" (14). Use with BTS, 7417K, 355.5 or 355.6							62
	842.802	Ea. Insert for PT10, 5/8"—3/4" (16—19). Use with BTS, 7417K, 355.5 or 355.6							74
	842.803	Ea. Insert for PT10, 13/16"—7/8" (20—22). Use with BTS, 7417K, 355.5 or 355.6							92
	842.804	Ea. Insert for PT20, 5/16"—1/2" (8—12). Use with PT21M, PT24M, PT25M, or MUNDUS PT30, 40, 41 w Pivot							56
	842.805	Ea. Insert for PT20, 9/16" (14). Use with PT21M, PT24M, PT25M, or MUNDUS PT30, 40, 41 w Pivot							62
	842.806	Ea. Insert for PT20, 5/8"—3/4" (16—19). Use with PT21M, PT24M, PT25M, or MUNDUS PT30, 40, 41 w Pivot							74
	842.807	Ea. Insert for PT20, 13/16"—7/8" (20—22). Use with PT21M, PT24M, PT25M, or MUNDUS PT30, 40, 41 w Pivot							92
	842.808	Ea. Insert for PT30, PT40, PT41, Pivot, 5/16"—1/2" (8—12)							77
	842.809	Ea. Insert for PT30, PT40, PT41, Pivot, 9/16" (14)							79
	842.810	Ea. Insert for PT30, PT40, PT41, Pivot, 5/8"—3/4" (16—19)							82
	842.811	Ea. Insert for PT30, PT40, PT41, Pivot, 13/16"—7/8" (20—22)							93

* Old DORMA finish code

3 Standard or Non-Standard Fabricated; lead time up to 3 business days.
 SO Special Fabricated/Finish or Special Order; lead time up to 5 weeks.

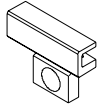
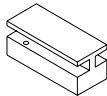
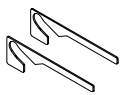
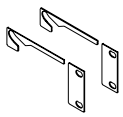
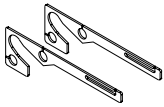
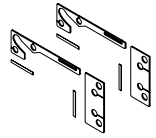
MUNDUS Premium & Comfort Patch Fittings

Replacement Parts & Accessories

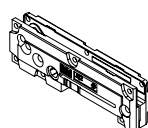
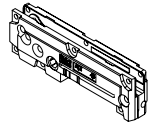
Model	Ref. #	U/M Description	List \$
	842.812	Ea. Insert for PT30, & PT40, Stop. 5/16"–7/8" (8–22)	55
	842.813	Ea. Insert for PT30, & PT40, Blank. 5/16"–9/16" (8–14)	43
	842.814	Ea. Insert for PT30, & PT40, Blank. 5/8"–7/8" (16–22)	49
Gaskets			
	842.820	St. Gasket for use with PT10, PT20, PT30 fittings (MUNDUS)	8
	842.824	St. Gasket for use with PT40 (MUNDUS)	14
	842.821	St. Tempered Laminate Gasket for use with PT10, PT20, PT30 fittings	10
	842.825	St. Tempered Laminate Gasket for use with PT40	18
Tempered Laminated Glass (TLG) Accessories			
	934.800	Ea. 3M™ Scotch-Weld™ Urethane Adhesive, DP 605 NS, off white, 1 tube per 20 fittings	78
	934.801	Ea. 3M™ Scotch-Weld™ EPX™ plus II applicator with 2:1 and 1:1 plunger	330
	934.805	Ea. 3M™ Scotch-Weld™ EPX™ plus II mixing square nozzle, 5.3; 4 tips per set (each tip supports 2 fittings/1 door)	10
Fitting Plates			
	842.840	Pr. MUNDUS Comfort Fitting Plates for PT10, PT20 (5/16"–1/2" [8–12])	63
	842.841	Pr. MUNDUS Comfort Fitting Plates for PT30 (5/16"–1/2" [8–12])	63

DRS Rails, Channels & Accessories

Patch Fittings & Designer Pivots

Offset Hung Patch Fittings

Headers & Accessories

Closers & Hardware

Locksets

Pulls & Handles



Sliding Systems

MANET

Panic Hardware

MUNDUS Premium & Comfort Patch Fittings

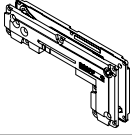
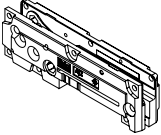
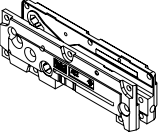
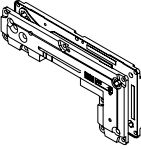
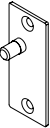
Accessories

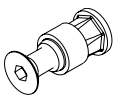
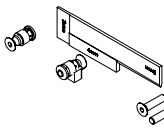
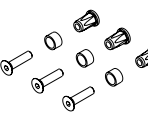
Fitting Plates			Standard Finishes \$			List \$
	842.842	Pr. MUNDUS Comfort Fitting Plates for PT40 (5/16"–1/2" [8–12])				93
	842.860	Pr. MUNDUS Premium Fitting Plates for PT10, PT20 (9/16"–7/8" [14–22])				102
	842.861	Pr. MUNDUS Premium Fitting Plates for PT30 (9/16"–7/8" [14–22])				102
	842.862	Pr. MUNDUS Premium Fitting Plates for PT40 (9/16"–7/8" [14–22])				147
			695/693 (108/109*)	728 (599*)	630/629 (700/701*)	
Wall Plate			3	SO	SO/3	
	838.313	Ea. Wall Plate, MUNDUS PT30	33	59	24	
Wall Anchor or Threaded Rod			List \$			
	901.133	Ea. Wall Anchor				12
	901.134	Ea. Threaded Rod Anchor				16
Accessory Packs			List \$			
	842.940	Pk. Accessory pack for PT10, PT20, PT30 for 5/16" to 1/2" glass. Single set.				7
	842.880	Pk. Accessory pack for PT10, PT20, PT30 for 5/16"–9/16" (8–14) glass				15
	842.881	Pk. Accessory pack for PT10, PT20, PT30 for 5/8"–3/4" (16–19) glass				16
	842.882	Pk. Accessory pack for PT10, PT20, PT30 for 13/16"–7/8" (20–22) glass				17
	842.883	Pk. Accessory pack for PT40, PT60 for 5/16"–9/16" (8–14) glass				16
	842.884	Pk. Accessory pack for PT40, PT60 for 5/8"–3/4" (16–19) glass				17
	842.885	Pk. Accessory pack for PT40, PT60 for 13/16"–7/8" (20–22) glass				18





3 Standard or Non-Standard Fabricated; lead time up to 3 business days.

* Old DORMA finish code

SO Special Fabricated/Finish or Special Order; lead time up to 5 weeks.

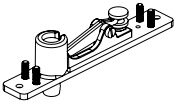
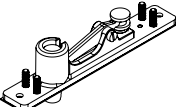
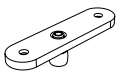
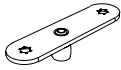
MUNDUS Premium & Comfort Patch Fittings

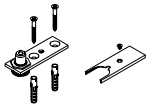
Accessories

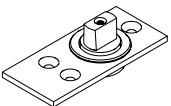
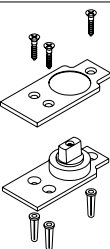
Model	Ref. #	U/M	Description	Standard Finishes \$			
				628 (101*)	710/711 (108/109*)	728 (599*)	630/629 (700/701*)
Top Pivots				3	3	3	3
	838.212	Ea.	MUNDUS PT21M pivot, Top Walking Beam Pivot, Frame	51	—	—	—
	838.211	Set	MUNDUS PT21M pivot, Top Walking Beam Pivot, Frame & Cover	68	68	68	68
	838.242	Ea.	MUNDUS PT24M pivot with mounting plate, mortise into ceiling	30	—	—	—
	838.243	Ea.	MUNDUS PT24M pivot with mounting plate, fasten onto ceiling	30	—	—	37 (630 only)
	838.251	Ea.	MUNDUS PT25M pivot, far right	19 (no finish)			
Floor Pivots				1	SO	SO	1
	201.106	Ea.	Complete, Adjustable Floor Pivot 5/16"–1/2" (8–12)	92	94	96	96
	901.079	Ea.	Adjustable Floor Pivot Cover Plate	20	23	24	25
	904.602	Ea.	Floor Pivot 5/16" (8) Clearance	47 ^{SO} (no finish)			
	229.003	Ea.	Complete, Floor Pivot with 3/4" (22) Clearance	74	74	74	74

3 Standard or Non-Standard Fabricated; lead time up to 3 business days.

* Old DORMA finish code

DRS Rails,
Channels &
Accessories

Patch Fittings
& Designer
Pivots

Offset
Hung Patch
Fittings

Headers &
Accessories

Closers &
Hardware

Locksets

Pulls &
Handles

Sliding
Systems

MANET

Panic
Hardware

Universal Patch Fittings, Complete

2-3/4" (70) Pivot Center Line, Center Hung

Type A, BP, and F Doors

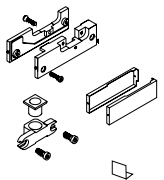
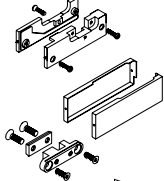
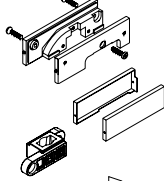
Model	Ref. #	U/M	Description	Standard Finishes \$					Custom Finishes \$	
				101	108/109	503/599	600/601	700/701	999	Cladding
Top Patch PT20 (PT21, 325.6, or 319.3)				3	3	SO	SO	3	SO	SO
 <p>End Cover 5/8" (16) & 3/4" (19)</p>	833.310	Ea.	3/8" (10)	65	79	112	150	89	108	195
	833.110	Ea.	1/2" (12)	65	79	112	150	89	108	195
	833.311	Ea.	5/8" (15)	110	132	155	213	136	153	277
	833.111	Ea.	3/4" (19)	110	132	155	213	136	153	277
Top Patch PT22 (RTS)										
 <p>End Cover 5/8" (16) & 3/4" (19)</p>	833.312	Ea.	3/8" (10)	74	89	120	158	96	117	205
	833.112	Ea.	1/2" (12)	74	89	120	158	96	117	205
	833.313	Ea.	5/8" (15)	118	141	163	220	143	160	287
	833.113	Ea.	3/4" (19)	118	141	163	220	143	160	287
Bottom Patch PT10 (BTS, 7471K, or 355.5)										
 <p>End Cover 5/8" (16) & 3/4" (19)</p>	833.300	Ea.	3/8" (10)	70	83	116	153	93	112	199
	833.100	Ea.	1/2" (12)	70	83	116	153	93	112	199
	833.301	Ea.	5/8" (15)	113	136	158	216	139	156	281
	833.101	Ea.	3/4" (19)	113	136	158	216	139	156	281
Patch Fitting Options									Net Add \$	
POWDER All Custom powder coated orders will include a net charge per purchase order.									200	

3 Standard or Non-Standard Fabricated; lead time up to 3 business days.

SO Special Fabricated/Finish or Special Order; lead time up to 5 weeks.



NOTES:

- Patch fitting covers for bronze finish are bronze plating over brass base metal.
- For 5/8" (16) and 3/4" (19) thick glass, a relief cut to the hole preparation will be required.

Universal Patch Fittings, Complete

2-3/4" (70) Pivot Center Line, Center Hung

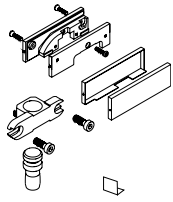
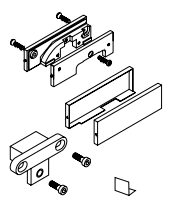
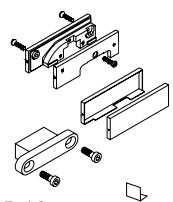
Type A, BP, and F Doors

Model	Ref. #	U/M	Description	Standard Finishes \$					Custom Finishes \$	
				101	108/109	503/599	600/601	700/701	999	Cladding
Transom Patch PT30 with Pivot (319.3)				(SO)	(SO)	(SO)	(SO)	(SO)	(SO)	(SO)
 <p>End Cover 5/8" (16) & 3/4" (19)</p>	833.330	Ea.	3/8" (10)	80	96	128	166	103	123	216
	833.131	Ea.	1/2" (12)	80	96	128	166	103	123	216
	833.321	Ea.	5/8" (15)	124	149	171	229	163	167	297
	833.121	Ea.	3/4" (19)	124	149	171	229	163	167	297
	Transom Patch PT30 with Stop (355.42)									
 <p>End Cover 5/8" (16) & 3/4" (19)</p>	833.332	Ea.	3/8" (10)	80	96	128	166	103	123	216
	833.132	Ea.	1/2" (12)	80	96	128	166	103	123	216
	833.333	Ea.	5/8" (15)	124	149	171	229	163	167	297
	833.133	Ea.	3/4" (19)	124	149	171	229	163	167	297
	Transom Patch PT30 with Blank (355.43)									
 <p>End Cover 5/8" (16) & 3/4" (19)</p>	833.334	Ea.	3/8" (10)	77	93	125	160	97	120	209
	833.134	Ea.	1/2" (12)	77	93	125	160	97	120	209
	833.335	Ea.	5/8" (15)	120	143	168	218	157	163	284
	833.135	Ea.	3/4" (19)	120	143	168	218	157	163	284
	Wall Plate					3 / (SO)			3 / (SO)	
	903.128	Ea.	Wall Plate	21	30 / 30	72	72	72 / 78		
	Wall Anchor or Threaded Rod									
	901.133	Ea.	Wall Anchor							12
	901.134	Ea.	Threaded Rod Anchor							16
Patch Fitting Options										Net Add \$
POWDER				All Custom powder coated orders will include a net charge per purchase order.						200

- 3 Standard or Non-Standard Fabricated; lead time up to 3 business days.
- (SO) Special Fabricated/Finish or Special Order; lead time up to 5 weeks.

- NOTES:**
- Patch fitting covers for bronze finish are bronze plating over brass base metal.
 - For 5/8" (16) and 3/4" (19) thick glass, a relief cut to the hole preparation will be required.

DRS Rails, Channels & Accessories
Patch Fittings & Designer Pivots
Offset Hung Patch Fittings
Headers & Accessories
Closers & Hardware
Locksets
Pulls & Handles
Sliding Systems
MANET
Panic Hardware

Universal Patch Fittings, Complete

2-3/4" (70) Pivot Center Line, Center Hung

Type A, BP, and F Doors

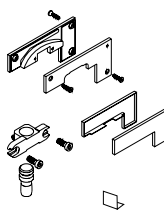
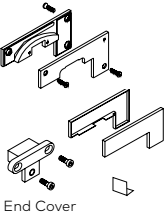
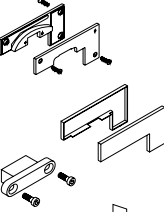
Model	Ref. #	U/M	Description	Standard Finishes \$					Custom Finishes \$	
				101	108/109	503/599	600/601	700/701	999	Cladding
Transom/Sidelite Patch Fitting PT40 with Pivot (319.3)				(SO)	(SO)	(SO)	(SO)	(SO)	(SO)	(SO)
 <p>End Cover 5/8" (16) & 3/4" (19)</p>	833.343	Ea.	3/8" (10)	120	144	189	197	170	163	256
	833.143	Ea.	1/2" (12)	120	144	189	197	170	163	256
	833.344	Ea.	5/8" (15)	137	165	223	239	203	180	310
	833.144	Ea.	3/4" (19)	137	165	223	239	203	180	310
Transom/Sidelite Patch Fitting PT40 with Stop (355.42)										
 <p>End Cover 5/8" (16) & 3/4" (19)</p>	833.336	Ea.	3/8" (10)	120	144	189	197	170	163	256
	833.136	Ea.	1/2" (12)	120	144	189	197	170	163	256
	833.337	Ea.	5/8" (15)	137	165	223	239	203	180	310
	833.137	Ea.	3/4" (19)	137	165	223	239	203	180	310
Transom/Sidelite Patch Fitting PT40 with Blank (355.43)										
 <p>End Cover 5/8" (16) & 3/4" (19)</p>	833.338	Ea.	3/8" (10)	116	139	185	193	166	158	216
	833.138	Ea.	1/2" (12)	116	139	185	193	166	158	216
	833.339	Ea.	5/8" (15)	132	158	218	234	199	174	259
	833.139	Ea.	3/4" (19)	132	158	218	234	199	174	259

Patch Fitting Options	Net Add \$
POWDER All Custom powder coated orders will include a net charge per purchase order.	200

- 3 Standard or Non-Standard Fabricated; lead time up to 3 business days.
- (SO) Special Fabricated/Finish or Special Order; lead time up to 5 weeks.

- NOTES:**
- Patch fitting covers for bronze finish are bronze plating over brass base metal.
 - For 5/8" (16) and 3/4" (19) thick glass, a relief cut to the hole preparation will be required.

Universal Patch Fittings, Complete

2-3/4" (70) Pivot Center Line, Center Hung

Type A, BP, and F Doors

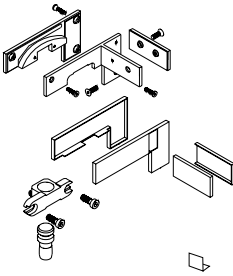
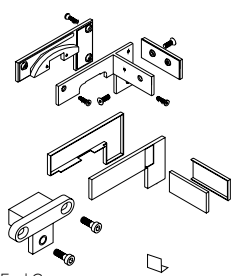
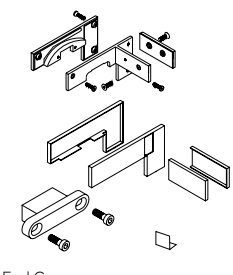
Model	Ref. #	U/M	Description	Standard Finishes \$					Custom Finishes \$	
				101	108/109	503/599	600/601	700/701	999	Cladding
Transom/Sidelite/Fin Patch Fitting PT41 with Pivot (319.3)				(SO)	(SO)	(SO)	(SO)	(SO)	(SO)	(SO)
 <p>End Cover 5/8" (16) & 3/4" (19)</p>	833.355	LH Ea.	3/8" (10)	296	356	391	391	368	361	508
	833.354	RH Ea.	3/8" (10)	296	356	391	391	368	361	508
	833.155	LH Ea.	1/2" (12)	296	356	391	391	368	361	508
	833.154	RH Ea.	1/2" (12)	296	356	391	391	368	361	508
	833.356	LH Ea.	5/8" (15)	370	444	480	489	458	434	636
	833.357	RH Ea.	5/8" (15)	370	444	480	489	458	434	636
	833.156	LH Ea.	3/4" (19)	370	444	480	489	458	434	636
833.157	RH Ea.	3/4" (19)	370	444	480	489	458	434	636	
Transom/Sidelite/Fin Patch Fitting PT41 with Stop (355.42)										
 <p>End Cover 5/8" (16) & 3/4" (19)</p>	833.391	LH Ea.	3/8" (10)	296	356	391	391	368	361	508
	833.393	RH Ea.	3/8" (10)	296	356	391	391	368	361	508
	833.191	LH Ea.	1/2" (12)	296	356	391	391	368	361	508
	833.193	RH Ea.	1/2" (12)	296	356	391	391	368	361	508
	833.392	LH Ea.	5/8" (15)	370	444	480	489	458	434	636
	833.394	RH Ea.	5/8" (15)	370	444	480	489	458	434	636
	833.192	LH Ea.	3/4" (19)	370	444	480	489	458	434	636
833.194	RH Ea.	3/4" (19)	370	444	480	489	458	434	636	
Transom/Sidelite/Fin Patch Fitting PT41 with Blank (355.43)										
 <p>End Cover 5/8" (16) & 3/4" (19)</p>	833.395	LH Ea.	3/8" (10)	292	352	386	386	364	356	504
	833.397	RH Ea.	3/8" (10)	292	352	386	386	364	356	504
	833.195	LH Ea.	1/2" (12)	292	352	386	386	364	356	504
	833.197	RH Ea.	1/2" (12)	292	352	386	386	364	356	504
	833.396	LH Ea.	5/8" (15)	366	440	476	485	454	430	631
	833.398	RH Ea.	5/8" (15)	366	440	476	485	454	430	631
	833.196	LH Ea.	3/4" (19)	366	440	476	485	454	430	631
833.198	RH Ea.	3/4" (19)	366	440	476	485	454	430	631	
Patch Fitting Options										List \$
NSTDFIN				Custom Fins may be available; other than 1/2" (12), verify with Customer Service.						160
										Net Add \$
POWDER				All Custom powder coated orders will include a net charge per purchase order.						200

(SO) Special Fabricated/Finish or Special Order; lead time up to 5 weeks.

NOTES:

- LH shown above.
- Patch fitting covers for bronze finish are bronze plating over brass base metal.
- All fins are designed for 1/2" (12) glass. Verify with Customer Service to determine if available for other than 1/2" (12).
- **Limited** quantities available for 3 business day lead-time. Verify availability at time of order.
- For 5/8" (16) and 3/4" (19) thick glass, a relief cut to the hole preparation will be required.

DRS Rails, Channels & Accessories
Patch Fittings & Designer Pivots
Offset Hung Patch Fittings
Headers & Accessories
Closers & Hardware
Locksets
Pulls & Handles
Sliding Systems
MANET
Panic Hardware

Transom and Sidelite Connectors, Complete

2-3/4" (70) Pivot Center Line

Type A, BP, and F Doors

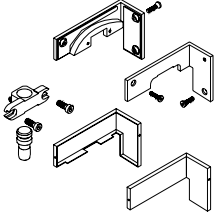
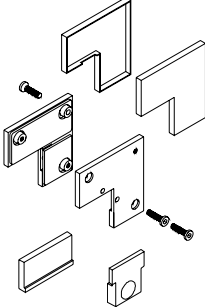
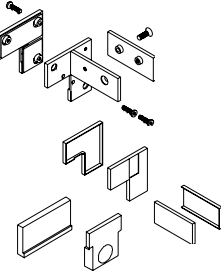
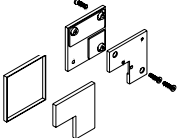
Model	Ref. #	U/M	Description	Standard Finishes \$				Custom Finishes \$	
				101	108/109	503	700/701	999	Cladding
Transom/90° Sidelite Patch Fitting PT42-90 with Pivot, (319.3)				(SO)	(SO)	(SO)	(SO)	(SO)	(SO)
	833.164	LH Ea.	1/2" (12)	835	887	—	967	963	1,302
	833.165	RH Ea.	1/2" (12)	835	887	—	967	963	1,302
Transom/Sidelite Connector PT60-61 with Stop and Blank Insert, (323.5)									
	803.150	Ea.	3/8" (10)	62	74	125	105	107	209
	803.150	Ea.	1/2" (12)	62	74	125	105	107	209
	803.452	Ea.	5/8" (15)	79	94	141	121	124	230
	803.452	Ea.	3/4" (19)	79	94	141	121	124	230
				Specify thickness (108 only)					
				Specify thickness (108 only)					
Transom/Sidelite/Fin Connector PT60-61 (Specify Thickness)									
	803.158	LH Ea.	3/8" (10)	62	74	—	105	129	209
	803.157	RH Ea.	3/8" (10)	62	74	—	105	129	209
	803.158	LH Ea.	1/2" (12)	62	74	—	105	129	209
	803.157	RH Ea.	1/2" (12)	62	74	—	105	129	209
Transom/Sidelite/Stop Connector PT62									
	803.173	Ea.	3/8" (10)	109	—	—	180	152	309
	803.173	Ea.	1/2" (12)	109	—	—	180	152	309
Patch Fitting Options									List \$
NSTDFIN	Custom Fins may be available; other than 1/2" (12), verify with Customer Service.							160	
									Net Add \$
POWDER	All Custom powder coated orders will include a net charge per purchase order.							200	

(SO) Special Fabricated/Finish or Special Order; lead time up to 5 weeks.

NOTES:

- All fins are designed for 1/2" (12) glass. Verify with Customer Service to determine if available for other than 1/2" (12).
- For 5/8" (15) and 3/4" (19) thick glass, a relief cut to the hole preparation will be required.

Transom and Sidelite Connectors, Complete

2-3/4" (70) Pivot Center Line

Type A, BP, and F Doors

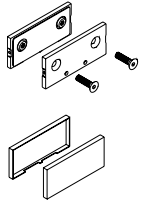
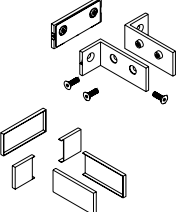
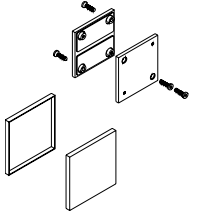
Model	Ref. #	U/M	Description	Standard Finishes \$				Custom Finishes \$		
				101	108/109	503/599	700/701	999	Cladding	
Transom Connector PT70 with 2 Ea. Stops/Blanks				(SO)	(SO)	(SO)	(SO)	(SO)	(SO)	
	801.150	Ea.	3/8" (10)	138	199	244	182	208	291	
	801.150	Ea.	1/2" (12)	138	199	244	182	208	291	
	801.158	Ea.	5/8" (15)	139	205	270	201	210	294	
	801.158	Ea.	3/4" (19) Specify Thickness	139	205	270	201	210	294	
Transom/Fin Connector PT71										
	801.161	Ea.	3/8" (10)	516	—	906	667	725	1,188	
	801.161	Ea.	1/2" (12)	516	—	906	667	725	1,188	
Sidelite Patch Fitting PT80										
	803.170	Ea.	3/8" (10)	126	—	—	207	174	226	
	803.170	Ea.	1/2" (12)	126	—	—	207	174	226	
	803.472	Ea.	5/8" (15) Specify Thickness	132	—	—	198	184	250	
	803.472	Ea.	3/4" (19) Specify Thickness	132	—	—	198	184	250	
Patch Fitting Options									List \$	
NSTDFIN	Custom Fins may be available; other than 1/2" (12), verify with Customer Service.									160
									Net Add \$	
POWDER	All Custom powder coated orders will include a net charge per purchase order.									200

(SO) Special Fabricated/Finish or Special Order; lead time up to 5 weeks.

NOTES:

- All fins are designed for 1/2" (12) glass. Verify with Customer Service to determine if available for other than 1/2" (12).
- For 5/8" (16) and 3/4" (19) thick glass, a relief cut to the hole preparation will be required.

DRS Rails, Channels & Accessories
Patch Fittings & Designer Pivots
Offset Hung Patch Fittings
Headers & Accessories
Closers & Hardware
Locksets
Pulls & Handles
Sliding Systems
MANET
Panic Hardware

Connector Fittings, Complete

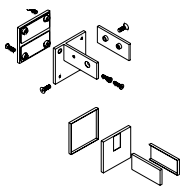
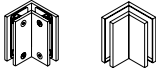
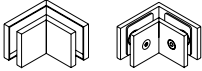
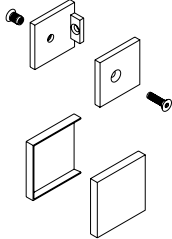
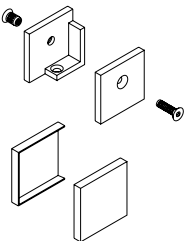
Model	Ref. #	U/M	Description	Standard Finishes \$			Custom Finishes \$	
				101	108/109	700/701	999	Cladding
Connector/Fin Fitting PT81				(S0)	(S0)	(S0)	(S0)	(S0)
	803.175	Ea.	3/8" (10)	548	—	724	76	919
	803.175	Ea.	1/2" (12)	548	—	724	76	919
90° Angled Connector PT80-90								
	803.171	Ea.	3/8" (10)	643	897 (108 only)	745	897	1,166
	803.171	Ea.	1/2" (12)	643	897 (108 only)	745	897	1,166
90° Angled Connector PT80-90 Short								
	803.470	Ea.	3/8" (10)	425	596 (108 only)	538	596	796
	803.470	Ea.	1/2" (12)	426	596 (108 only)	538	596	796
Edge Fitting PT90								
	807.021	Ea.	3/8" (10)	48	76	107	76	150
	807.021	Ea.	1/2" (12)	48	76 (108 only)	107	76	150
	807.210	Ea.	5/8" (15) Specify Thickness	56	66 (108 only)	111	98	129
	807.210	Ea.	3/4" (19) Specify Thickness	56	66 (108 only)	111	98	129
Corner Fitting PT91								
	807.023	Ea.	3/8" (10)	71	104 (108 only)	126	104	167
	807.023	Ea.	1/2" (12)	71	104 (108 only)	126	104	167
	807.211	Ea.	5/8" (15) Specify Thickness	76	110 (108 only)	131	110	144
	807.211	Ea.	3/4" (19) Specify Thickness	76	110 (108 only)	131	110	144
Patch Fitting Options								List \$
NSTDFIN	Custom Fins may be available; other than 1/2" (12), verify with Customer Service.							160
								Net Add \$
POWDER	All Custom powder coated orders will include a net charge per purchase order.							200







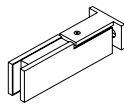

③ Standard or Non-Standard Fabricated; lead time up to 3 business days.

(S0) Special Fabricated/Finish or Special Order; lead time up to 5 weeks.

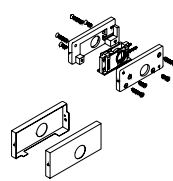
NOTES:

- All fins are designed for 1/2" (12) glass. Verify with Customer Service to determine if available for other than 1/2" (12).
- For 5/8" (16) and 3/4" (19) thick glass, a relief cut to the hole preparation will be required.

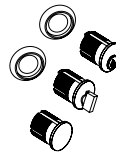
Connectors, Complete, and Accessories

Model	Ref. #	U/M	Description	Standard Finishes \$				Custom Finishes \$	
				101	108/109	503/599	700/701	999	Cladding
Top Patch Fitting PT29 with Wall Mount Pivot Fixing Plate				(SO)	(SO)	(SO)	(SO)	(SO)	(SO)
	833.314	Ea.	3/8" (10)	224	268	334	—	266	434
	833.109	Ea.	1/2" (12)	224	268	334	—	266	434
NOTE: 2-3/16" (55mm) Pivot Center Line Location. Bottom Pivot Must Use Same Pivot Point!									
	801.153	Ea.	3/8" (10)	170	203	264	234	213	343
	801.153	Ea.	1/2" (12)	170	203	264	234	213	343
Patch Lock Fitting AR20 Type F Door				3	3		3		
	801.124	Ea.	3/8" (10)	104	127	189	157	147	246
	801.122	Ea.	1/2" (12)	104	127	189	157	147	246
				(SO)	(SO)		(SO)		
	801.126	Ea.	5/8" (15)	184	208	270	238	227	351
	801.125	Ea.	3/4" (19)	184	208	270	238	227	351
Slide-On Bolt, 3/8" (10) glass only				(SO)					
	912.302	Ea.	3/4" (19)	98	—	—	—	—	—
Extended Bolt, 7/8" Throw				3					
	925.021	Ea.	Extended Bolt, 7/8" (22) Throw	16	—	—	—	—	—
NOTE: When fully retracted, bolt will remain extended 1/4" (6).									
Extended Bolt, 7/8" Throw				(SO)					
	925.022	Ea.	Square Bolt	6	—	—	—	—	—
								Standard Finishes \$	
								108	500/501
Cylinders for Patch Fitting Brass Lock								(1)	(SO)
	225.997	Ea.	Mortise cylinder for Patch Fitting lock, with blocking ring if cylinder requires master keying lead time goes to Special Order (SO)					21	21
	225.996	Ea.	Mortise Thumbturn for Patch Fitting Lock, with blocking ring					21	21
	225.995	Ea.	Mortise Dummy (blank) Cylinder for Patch Fitting Lock, with blocking ring					15	15
								Finishes \$	
Model	Ref. #	U/M	Description	101	109	500/501	503/599	600/601	
	932.033	Ea.	Dust Proof Strike Overall Length 1-1/2" (40)	30 (1)	30 (1)	30 (1)	30 (SO)	30 (SO)	



- (1) Non-Fabricated item, ships in 1 business day.
- (3) Standard or Non-Standard Fabricated; lead time up to 3 business days.
- (SO) Special Fabricated/Finish or Special Order; lead time up to 5 weeks.

NOTES:

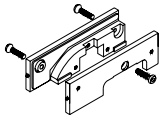
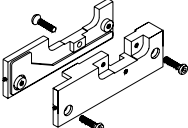
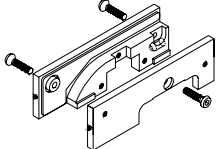
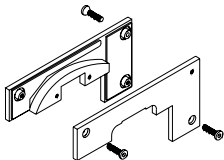
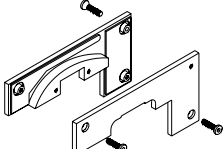
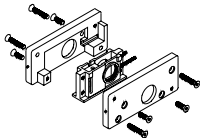
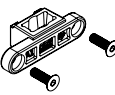

- All fins are designed for 1/2" (12) glass. Verify with Customer Service to determine if available for other than 1/2" (12).
- For 5/8" (16) and 3/4" (19) thick glass, a relief cut to the hole preparation will be required.

- DRS Rails, Channels & Accessories
- Patch Fittings & Designer Pivots
- Offset Hung Patch Fittings
- Headers & Accessories
- Closers & Hardware
- Locksets
- Pulls & Handles
- Sliding Systems
- MANET
- Panic Hardware

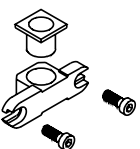
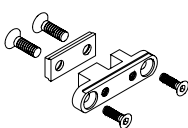
Center Hung Patch Fitting Options

	Ref. #	Model	Description	Standard Finishes \$				
				101	108	700/701	600	No Finish
	903.997	317.12	Fitting for PT10, PT20, PT22, 3/8" (10), or 1/2" (12) glass	—	—	—	—	30
	903.308	317.19	Fitting for PT10, PT20, PT22, PT30, 5/8" (15), or 3/4" (19) glass	—	—	—	—	60
	903.998	317.35	Fitting for PT30, 3/8" (10), or 1/2" (12) glass	—	—	—	—	30
	903.309	317.412	Fitting for PT40, 3/8" (10), or 1/2" (12) glass	—	—	—	—	68
	903.310	317.419	Fitting for PT40, 5/8" (15), or 3/4" (19) glass	—	—	—	—	68
	901.123	351.3	AR20 Patch lock Fitting, 3/8" (10), 1/2" (12), 5/8" (16), or 3/4" (19) glass	—	—	—	—	96
	903.105	319.1	Insert for PT 10 5/8" (15) – 3/4" (19) glass Use with BTS, 7471K, or 355.5	—	—	—	—	21
	903.115		Insert for PT 10 3/8" (10) – 1/2" (12) glass Use with BTS, 7471K, or 355.5	—	—	—	—	31
	903.111	319.2	Insert for PT20. Use with PT21, PT24, or PT30 with Pivot 319.3	—	—	—	—	17
	903.999	355.41	Insert for PT22 by RTS, Sideload	—	—	—	—	27

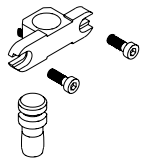
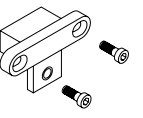
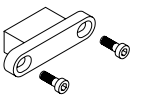
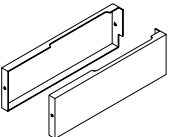
Center Hung Patch Fitting Options

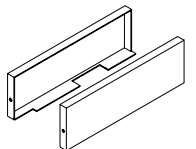
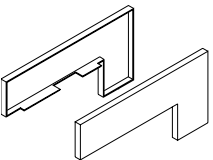
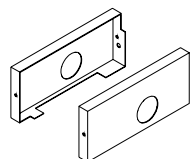
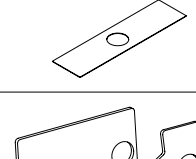
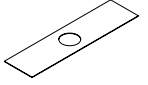
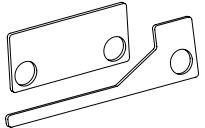
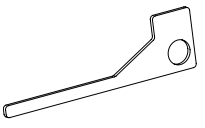
	Ref. #	Model	Description	Standard Finishes \$				
				101	108	700/701	600	No Finish
	903.125	319.3	Insert with pivot 319.3 for PT30, PT40, PT41, PT42	—	—	—	—	21
	903.127	355.42	Insert with stop for PT30, PT40, PT41	—	—	—	—	21
	903.126	355.43	Insert with blank for PT30, PT40, PT41	—	—	—	—	17
	903.104	340.1	Cover, patch fitting,. Use with PT10, PT20, PT22	24	45	48	110	—
	903.025	317.19	Cover, end angle, all PT10, PT20, PT22 x 5/8 (15) or 3/4 (19) glass	17	19	36	N/A	—
	903.124	340.5	Cover, patch fitting. Use with PT30	25	47	50	N/A	—
	903.144	340.4	Cover, patch fitting. Use with PT40	39	117	92	N/A	—
	903.261	351.4	Cover, AR20 patch lock fitting for 3/8" (10) and 1/2" (12) glass	96	108	148	N/A	—
	903.262	—	Cover, AR20 patch lock fitting for 5/8" (15) and 3/4" (19) glass	96	108	148	NA	—
	903.023	—	Cover, all PT30, PT40, PT41 x 5/8" (15) or 3/4" (19) glass	17	19	36	N/A	—
	903.140	—	Gasket 3 for use with PT40 fittings x 3/8" (10) or 5/8" (15) glass	—	—	—	—	4
	903.014	—	Gasket 2 for use with PT10, PT20, PT22, PT30 fittings x 1/2" (12) or 3/4" (19) glass	—	—	—	—	5

DRS Rails, Channels & Accessories

Patch Fittings & Designer Pivots

Offset Hung Patch Fittings

Headers & Accessories

Closers & Hardware

Locksets

Pulls & Handles

Sliding Systems

MANET

Panic Hardware

Patch Fitting Options	Net Add \$
POWDER	200

All Custom powder coated orders will include a **net charge** per purchase order.

Standard Center Hung Patch Fitting Set for Door

317.12
903.997

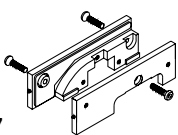

Fitting, 3/8" (10 or 1/2" (12) glass, PT10, PT20, PT22

317.19
903.308

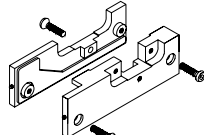

Fitting, 5/8" (15) or 3/4" (19) glass, PT10, PT20, PT22

319.1
903.105

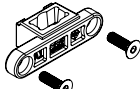

Insert for PT 10 5/8" (15) — 3/4" (19) glass use with BTS, 7471K, or 355.5

319.2
903.111

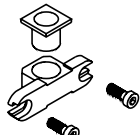

Insert fitting, PT20 x PT21

355.41
903.999

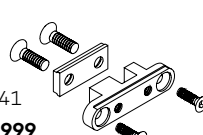

Insert fitting, PT22 x RTS

340.1
903.104

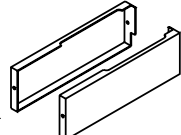

Patch fitting cover, all glass thicknesses, PT10, PT20, PT22

317.19
903.025

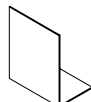

End cover, requested for 5/8" (15) or 3/4" (19) glass thicknesses, PT10, PT20, PT22

Standard Center Hung Patch Fitting Set for Transom PT30 Patch Fitting Guide

317.35
903.998

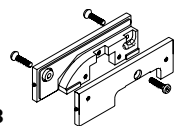

Fitting, 3/8" (10) or 1/2" (12) glass, PT30

317.19
903.308

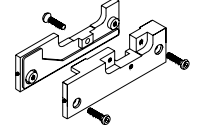

Fitting, 5/8" (15) or 3/4" (19) glass, PT30

319.3
903.125

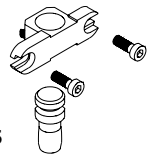

Insert fitting, PT30 x PT20

355.42
903.127

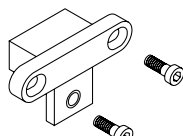

Insert fitting, PT30 when used as stop

319.3
903.126

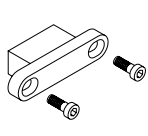

Insert fitting, PT30 x double acting door

340.5
903.124

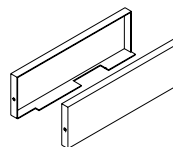

Patch fitting cover, all glass thicknesses, PT30

317.419
903.023

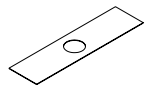

Cover PT30, 40, 41 5/8" (15), 3/4" (19) glass for 5/8" (15) or 3/4" (19) glass thicknesses, PT30

SENSOR Designer Pivot/Hinge

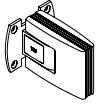
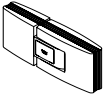





Model	Ref. #	U/M	Description	Finishes \$	
				114	113
TENSOR Glass to Wall				(SO)	3
	812.520	Pr.	3/8" (10) or 1/2" (12)	1,213	1,242
TENSOR Glass to Glass				(SO)	
	812.523	Pr.	3/8" (10) or 1/2" (12)	1,596	1,649

3 Standard or Non-Standard Fabricated; lead time up to 3 business days.
 (SO) Special Fabricated/Finish or Special Order; lead time up to 5 weeks.

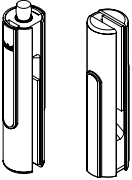
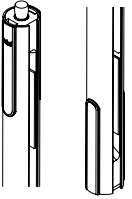
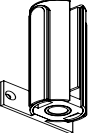
- DRS Rails, Channels & Accessories
- Patch Fittings & Designer Pivots
- Offset Hung Patch Fittings
- Headers & Accessories
- Closers & Hardware
- Locksets
- Pulls & Handles
- Sliding Systems
- MANET
- Panic Hardware

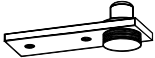
BEYOND Pinch-Free Pivot

Center Hung Double-Acting All-Glass Door System
 Safe pinch-free glass door operation for 3/8" and 1/2" (10 and 12) glass

Model	Ref. #	U/M	Description	Finishes \$	
				114	107
BEYOND Basic Pivot Set – Short				(SO)	(SO)
	Pivoting fitting set, short type, consists of: 1 top pivot fitting with pivot 15 dia., 1 bottom pivot fitting with insert for floor closer spindle or round pivot (ordered separately)				
	830.100	Set	3/8" (10)	600	733
	830.101	Set	1/2" (12)	600	—
BEYOND Basic Pivot Set – Long					
	Pivoting fitting, long type, with pivot dia. 15 at top and insert for floor closer spindle or round pivot at bottom (ordered separately). Please indicate "exact door height = glass measurement" with order.				
	830.110	Set	3/8" (10)	678	826
	830.111	Set	1/2" (12)	678	—
BEYOND Components					
	BEYOND Transom fitting, wall connector with plastic socket for top pivot				
	830.120	Ea.	3/8" (10)	285	347
	830.121	Ea.	1/2" (12)	298	—
	BEYOND Transom fitting, glass connector with plastic socket for top pivot				
	830.130	Ea.	3/8" (10)	290	354
	830.131	Ea.	1/2" (12)	290	—
				List \$	
BEYOND Components					(SO)
	901.106 .001	Ea.	Adjustable Floor Pivot 5/16" (8) to 1/2" (12) (no cover)		71
BEYOND Glass Connector					109
	830.320	Ea.	BEYOND glass connector for connection of sidelite at closing side 3/8" (10) and 1/2" (12)		42
Bearings and Bushings					List \$
	901.130	Ea.	Top pivot bearing (aluminum)		43
	805.194	Ea.	Eccentric socket, adjustable		54
	901.107	Ea.	Floor Bearing		78

(SO) Special Fabricated/Finish or Special Order; lead time up to 5 weeks.

Offset Hung Patch Fittings

Patch Fittings	For Single-Acting 1-11/16" (43) Offset Hung Doors	66
	For Single-Acting 5/16" (8), 3/8" (10) and 1/2" (12) Offset Hung Doors	69

NOTE: Refer to pages 91–108 for Closers and Hardware.

- DRS Rails, Channels & Accessories
- Patch Fittings & Designer Pivots
- Offset Hung Patch Fittings**
- Headers & Accessories
- Closers & Hardware
- Locksets
- Pulls & Handles
- Sliding Systems
- MANET
- Panic Hardware

1-11/16" (43 mm) Doors

Type A and F Doors – 3/8" (10) and 1/2" (12) Thick Glass

Offset Patch Fittings, Complete				Standard Finishes \$		Custom Finishes \$
Model	Ref. #	U/M	Description	101	108/109	107
Top of Door, Offset Patch Fitting 312.1				(S)	(S)	(S)
	902.110	Ea.	RH (LHR) (Shown)	255	364	362
	902.111	Ea.	LF (RHR)	255	364	362
Bottom of Door, Offset Patch Fitting 311.1						
	902.100	Ea.	RH (LHR) (Shown)	263	377	375
	902.101	Ea.	LF (RHR)	263	377	375
Transom, Offset Pivot Fitting 326.1						
	902.120	Ea.	RH (LHR) (Shown)	284	406	403
	902.121	Ea.	LF (RHR)	284	406	403
Transom/ Sidelite, Offset Pivot Fitting 327.1						
	902.140	Ea.	RH (LHR) (Shown)	333	479	476
	902.141	Ea.	LF (RHR)	333	479	476
Wall Anchor or Threaded Rod						List Add \$
	901.133	Ea.	Wall Anchor			12
	901.134	Ea.	Threaded Rod Anchor			16

(S) Special Fabricated/Finish or Special Order; lead time up to 5 weeks.

NOTES:

- Handing for angle of fin fittings viewed from outside and above as shown in diagram.
- Please specify glass thickness when ordering.

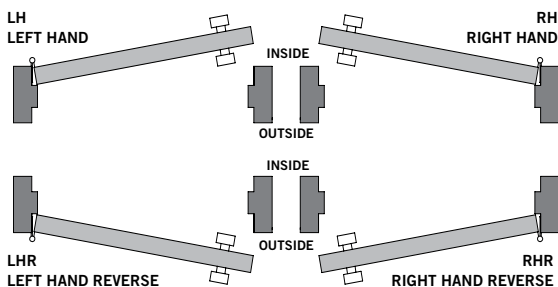

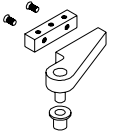
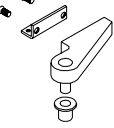
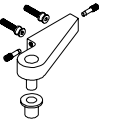
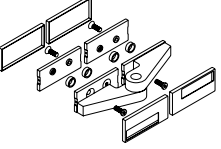
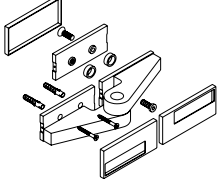
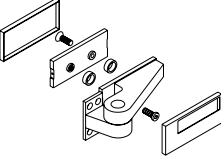
Offset Patch Fittings, Complete				Standard Finishes \$		Custom Finishes \$
Model	Ref. #	U/M	Description	101	108/109	107
Frame Mount Offset Patch Fitting 339.1				(S0)	(S0)	(S0)
	902.150	Ea.		151	219	314
Frame Mount Offset Patch Fitting 339.2						
	902.151	Ea.		151	219	314
Frame Mount Offset Patch Fitting 339.3						
	902.152	Ea.	RH (LHR)	151	219	314
	902.153	Ea.	LF (RHR)	151	219	314
Glass Door to Glass Sidelite Offset Patch Fitting 312.4						
	902.200	Ea.	RH (LHR) (Shown)	559	799	794
	902.201	Ea.	LF (RHR)	559	799	794
Wall to Glass Door Offset Patch Fitting 312.5						
	902.202	Ea.	RH (LHR) (Shown)	559	799	794
	902.203	Ea.	LF (RHR)	559	799	794
Wall to Glass Door Offset Patch Fitting 312.6						
	902.204	Ea.	RH (LHR) (Shown)	559	799	794
	902.205	Ea.	LF (RHR)	559	799	794

(S0) Special Fabricated/Finish or Special Order; lead time up to 5 weeks.

NOTES:

- Handing for angle of fin fittings viewed from outside and above as shown in diagram.
- USA HANDING SHOWN (OPPOSITE EUROPEAN HANDING).
- Please specify glass thickness when ordering.

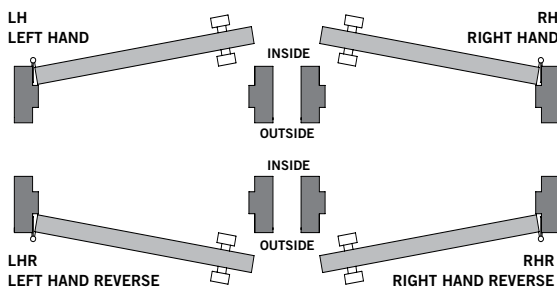

DRS Rails, Channels & Accessories
Patch Fittings & Designer Pivots
Offset Hung Patch Fittings
Headers & Accessories
Closers & Hardware
Locksets
Pulls & Handles
Sliding Systems
MANET
Panic Hardware

Offset Patch Fittings, Complete				Standard Finishes \$	
Model	Ref. #	U/M	Description	101	108/109
Top of Door Offset Patch Fitting 312.2 Type A & F shortened 19/32" (15) side only				(S0)	(S0)
	902.112	Ea.	3/8" (10) glass RH (LHR)	255	364
	902.113	Ea.	3/8" (10) glass LF (RHR)	255	364
	902.164	Ea.	1/2" (12) glass RH (LHR)	255	364
	902.165	Ea.	1/2" (12) glass LF (RHR)	255	364
Bottom of Door Offset Patch Fitting 311.2 Type A & F shortened 19/32" (15) side only					
	902.102	Ea.	3/8" (10) glass RH (LHR)	263	377
	902.103	Ea.	3/8" (10) glass LF (RHR)	263	377
	902.160	Ea.	1/2" (12) glass RH (LHR)	263	377
	902.161	Ea.	1/2" (12) glass LF (RHR)	263	377
Wall to Glass Door Offset Patch Fitting 312.7 Type A & F shortened 19/32" (15) side only					
	902.206	Ea.	3/8" (10) glass RH (LHR)	559	799
	902.207	Ea.	3/8" (10) glass LF (RHR)	559	799
	902.170	Ea.	1/2" (12) glass RH (LHR)	559	799
	902.171	Ea.	1/2" (12) glass LF (RHR)	559	799
Top of Door Offset Patch Fitting 312.3 Type A & F shortened 19/32" (15) top and side					
	902.114	Ea.	3/8" (10) glass RH (LHR)	255	364
	902.115	Ea.	3/8" (10) glass LF (RHR)	255	364
	902.166	Ea.	1/2" (12) glass RH (LHR)	255	364
	902.167	Ea.	1/2" (12) glass LF (RHR)	255	364
Bottom of Door Offset Patch Fitting 311.3 Type A & F shortened 19/32" (15) bottom and side					
	902.104	Ea.	3/8" (10) glass RH (LHR) (Shown)	263	377
	902.105	Ea.	1/2" (12 mm) glass LF (RHR)	263	377
	902.162	Ea.	3/8" (10) glass RH (LHR)	263	377
	902.163	Ea.	1/2" (12) glass LF (RHR)	263	377

(S0) Special Fabricated/Finish or Special Order; lead time up to 5 weeks.

NOTES:

- Handing for angle of fin fittings viewed from outside and above as shown in diagram.
- Please specify glass thickness when ordering.

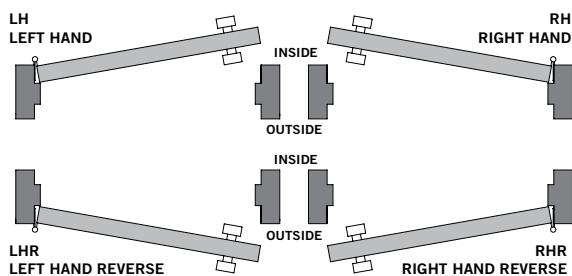

5/16" (8 mm), 3/8" (10 mm), and 1/2" (12 mm) Doors

Type A and F Doors – 3/8" (10) and 1/2" (12) Thick Glass

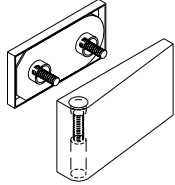
Offset Patch Fittings, Complete				Standard Finishes \$		Custom Finish \$
Model	Ref. #	U/M	Description	101	108	107
Top and Bottom of Door Offset Patch Fitting 412.1				(SO)	(SO)	(SO)
	912.040	Ea.	RH (LHR) (Shown)	249	284	334
	912.041	Ea.	LF (RHR)	249	284	334

(SO) Special Fabricated/Finish or Special Order; lead time up to 5 weeks.

NOTES:

- Handing for angle of fin fittings viewed from outside and above as shown in diagram.
- Please specify glass thickness when ordering.
- Maximum door weight 176 lb (80 kg).
- Maximum door width 43-1/4" (1100 mm).

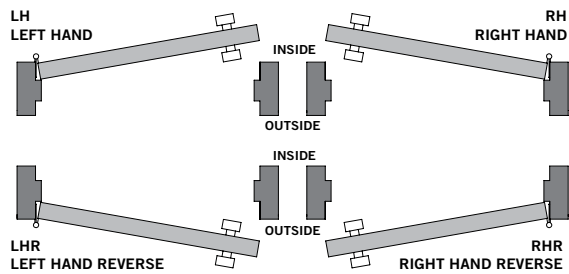

Headers and Accessories

	Select Service	72
Headers	Ordering Guide	73
	Standard Headers (36" and 72")	74
	Header — Single Opening	75
	Header — Paired Opening	76
	Narrow Header with PT21 — Single Opening	77
	Narrow Header with PT21 — Paired Opening	77
	MUNDUS PT21M Header — Single Opening	78
	MUNDUS PT21M Header — Paired Opening	78
	MUNDUS Narrow Header with PT21M — Single Opening	79
	MUNDUS Narrow Header with PT21M — Paired Opening	79
	Header Options	80
	RTS88 Options	80
	Optional Sidelite Headers	81
	Header Accessories and Service Parts	82
Floating Header for All-Glass Entrances with Transom	Ordering Guide	88
	Floating Header — Single Opening	89
	Floating Header — Paired Opening	89
	Floating Header with PT21M — Single Opening	90
	Floating Header with PT21M — Paired Opening	90

DRS Rails,
Channels &
Accessories

Patch Fittings
& Designer
Pivots

Offset
Hung Patch
Fittings

Headers &
Accessories

Closers &
Hardware

Locksets

Pulls &
Handles

Sliding
Systems

MANET

Panic
Hardware

Select Service Quick Ship — Headers and Accessories

Select service should be used for small quantities of popular dormakaba products that require shipment within 24 hours. The program includes patch fittings, DRS rails, headers, concealed closers and pivots, and pulls and handles. Warehouses have been set up in the east and west for faster delivery nationwide. (Customer responsible for shipping costs FOB.)

Subject to Availability

Next Business Day Service (Shipment when Purchase Order is received prior to 4:00 PM EST).

Examples: dormakaba receives P.O. at 3:59 PM on Monday, order will ship by close of business on Tuesday. dormakaba receives P.O. at 3:59 PM on Friday, order will ship by close of business on the following Monday.

Notes:

- Standard freight and discount schedules and terms of sale apply. Please refer to the current price list for full details.
- dormakaba reserves the right to limit quantities or decline an order if the credit status of the buyer is not satisfactory to dormakaba.
- Orders cannot be cancelled.
- Select Service Quick Ship available only in the United States.
- All prices are in U.S. dollars.
- Products and prices are subject to change without notice.
- Limited quantities available.

Key

N "New" to Select Service, Available in East and West Coast Warehouse

■ Available in East and West Coast Warehouse

E Available only in East Coast Warehouse

W Available only in West Coast Warehouse

Headers and Accessories

2-3/4" (70) Pivot Location

Ref. #	Warehouse	Product	Description	Finish	List \$
233.044.101.SS	E	Header	36" x 4.5" (914 x 114) with PT21 WBP (PT21 Pre-Installed)	101	176
233.044.700.SS	E	Header	36" x 4.5" (914 x 114) with PT21 WBP (PT21 Pre-Installed)	700	289
* 233.040.101.SSL	■	Header	36" x 4.5" (914 x 114) with RTS Prep (Prepared for RTS)	101	163
* 233.040.700.SSL	■	Header	36" x 4.5" (914 x 114) with RTS Prep (Prepared for RTS)	700	287
233.046.101.SS	E	Header	72" x 4.5" (1829 x 114) with 2 ea. PT21 WBP (PT21 Pre-Installed)	101	352
233.046.700.SS	E	Header	72" x 4.5" (1829 x 114) with 2 ea. PT21 WBP (PT21 Pre-Installed)	700	578
* 233.042.101.SSL	E	Header	72" x 4.5" (1829 x 114) with 2 ea. RTS88 Prep (Prepared for RTS)	101	326
* 233.042.700.SSL	E	Header	72" x 4.5" (1829 x 114) with 2 ea. RTS88 Prep (Prepared for RTS)	700	574

* Headers x RTS Prep are prepared for RTS installation. RTS sold separately.

Headers and Accessories

Ordering Guide

Doors/Panels

None	— No Door or Panels
2D/2P	— 2 Doors, 2 Panels w/Flat Covers
2D/2GP	— 2 Doors, 2 Panels w/Glazing Pockets
2D/1P	— 2 Doors, 1 Panel w/Flat Covers
2D/1GP	— 2 Doors, 1 Panel w/Glazing Pocket
2D	— 2 Doors
1D/2P	— 1 Door, 2 Panels w/Flat Covers
1D/2GP	— 1 Door, 2 Panel w/Glazing Pockets
1D/1P	— 1 Door, 1 Panel w/Flat Covers
1D/1GP	— 1 Door, 1 Panel w/Glazing Pocket
1D	— 1 Door

Glass Thickness

3/4
5/8
3/8
1/2

Cut Length Panel Two Specify

EC2 — Pack of 2 ea. End Caps

Length Specify — Specify Length

HDR _____ **1D** **FLTCVR** _____ **1/2** _____ continued below

HDR 1-3/4" x 4-1/8" (44 x 105) — **4-1/8**

Model 1-3/4" x 4-1/2" (44 x 114) — **4-1/2**

1-3/4" x 6" (44 x 152) — **6**

Header Width

FLTCVR _____ **Specify** — Specify Length

GLZCVR _____ **Cut Length Panel One**

Cover Options

Hardware

PT21
RTS88-5MM

Standard Spindle Location

Y
N

Closer Bumper Position

90
105

Closer Spring Size

SZ2
SZ4
BFE
BFI
SZ3

Miter

2
1

101 **RTS88-5MM** _____ **Y** _____ **105** **NHO** **SZ3** **SHEAR** _____

101 — Clear Anodized (CL) **LH** **RT588-5MM** **NHO** **SHEAR**

108 — Dark Bronze (DB) **RH** **PT21** **HO** **Shear Lock**

109 — Black Anodized (BK) **Hand** **PT21M** **Hold/Non-Hold Open**

503 — Polished Brass w/o Lacquer (PB)

599 — Satin Brass w/o Lacquer (SB)

600 — Satin Bronze w/o Lacquer (SBZ)

601 — Polished Bronze w/o Lacquer (PB2)

700 — Satin Stainless Steel (SS/US32D)

701 — Polished Stainless Steel (PS/US32)

Paired Hardware

Standard Finish

- 113** — Similar to Satin Stainless (Limited Availability)
- 199** — Custom Anodized Finishes (Specify)
- 299** — Custom Cladding (Specify)
- 399** — Powder Coated Finishes (Specify)

Custom Finish ^{1,2}

¹ dormakaba reserves the right to refuse Custom Finishes.
² All Custom Finishes require customer sign-off/approval of color chip.

DRS Rails, Channels & Accessories
 Patch Fittings & Designer Pivots
 Offset Hung Patch Fittings
 Headers & Accessories
 Closers & Hardware
 Locksets
 Pulls & Handles
 Sliding Systems
 MANET
 Panic Hardware

Standard Headers (36" and 72")

Ref. #	U/M	Length	Description	101 ③	700/701 ③
Single with 1-RTS88 (928.3xx) Installed, Flat Cover					
233.018	Ea.	36" (914)	4-1/8" (105)	381	493
233.040	Ea.	36" (914)	4-1/2" (114)	391	511
Single with 1-PT21 (801.117) Installed, Flat Cover					
233.036	Ea.	36" (914)	4-1/8" (105)	170	277
233.044	Ea.	36" (914)	4-1/2" (114)	171	280
Paired with 2-RTS88 (928.3xx) Installed, Flat Cover					
233.020	Ea.	72" (1829)	4-1/8" (105)	762	986
233.042	Ea.	72" (1829)	4-1/2" (114)	782	1,022
Paired with 2-PT21 (801.117) Installed, Flat Cover					
233.038	Ea.	72" (1829)	4-1/8" (105)	340	555
233.046	Ea.	72" (1829)	4-1/2" (114)	341	561
Single with 1-PT21M (838.212) Installed, Flat Cover					
233.021	Ea.	36" (914)	4-1/8" (105)	170	277
233.033	Ea.	36" (914)	4-1/2" (114)	171	280
Paired with 2-PT21M (838.212) Installed, Flat Cover					
233.022	Ea.	72" (1829)	4-1/8" (105)	340	555
233.035	Ea.	72" (1829)	4-1/2" (114)	341	561

③ Standard or Non-Standard Fabricated; lead time up to 3 business days.

Header, Single Opening

24" (610) to 48" (1219)

Ref. #	U/M	Length	Description	101	700
Select Service Header, Single less RTS				①	①
233.040.xxx.SS	Ea.	36" (914)	4-1/2" (114)	163	287
Select Service Header, Single with PT21				①	①
233.044.xxx.SS	Ea.	36" (914)	4-1/2" (114)	176	289

				Standard Finishes \$					Custom Finishes \$		
Model	Ref. #	U/M	Description	101	108/109	113	503/599	600/601	700/701	199/399	299

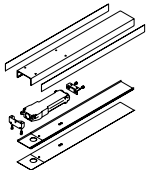
Single with 1-RTS88 (928.3xx) Installed, Flat Cover				Single Header Base Price							
	233.018	Ea.	4-1/8" (105)	393	409	433	590	757	508	564	978
	233.040	Ea.	4-1/2" (114)	403	421	—	619	798	527	593	1,034
	233.060	Ea.	6" (152)	454	473	498	656	828	572	649	1,109

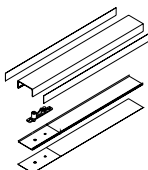
Single with 1-PT21 (801.117) Installed, Flat Cover				Single Header Base Price							
	233.036	Ea.	4-1/8" (105)	175	191	213	357	518	286	328	726
	233.044	Ea.	4-1/2" (114)	176	193	—	361	526	289	329	738
	233.064	Ea.	6" (152)	236	255	278	423	589	350	413	857

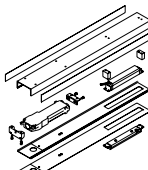
Single with 1-RTS88 (928.3xx) and 1-Shear Lock (933.025) Installed, Shear Lock Header Cap				Single Header Base Price							
	233.025	Ea.	4-1/8" (105)	1,980	1,997	2,043	2,237	2,410	2,141	2,173	2,687
	233.032	Ea.	4-1/2" (114)	1,993	2,012	—	2,272	2,459	2,163	2,241	2,744
	233.068	Ea.	6" (152)	2,041	2,061	2,108	2,303	2,481	2,205	2,258	2,818

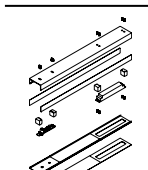
Single with 1-PT21 (801.117) and 1-Shear Lock (933.025) Installed				Single Header Base Price							
	233.023	Ea.	4-1/8" (105)	1,762	1,779	1,823	2,004	2,171	1,919	1,937	2,435
	233.043	Ea.	4-1/2" (114)	1,766	1,784	—	2,014	2,187	1,925	1,977	2,448
	233.072	Ea.	6" (152)	1,823	1,843	1,888	2,070	2,242	1,983	2,022	2,566

Header Options			List Add \$
PANIC	Prep for Glass Panic/Deadbolt Push Bar Device in dormakaba header, manual strike.		80
HDWPREP	Prep and Install of non-standard dormakaba hardware (e.g., offset pivots, arms, etc.) in dormakaba header.		80
ELOCKPREP	Prep and install of magnetic and electronic locks (e.g. EMLs and EMSLs)		300
CMP HDWP	Competitor hardware component preparation only for dormakaba header (e.g., pivots and arms). Charge may be reviewed based on complexity.		95
CMP HDWI	Competitors hardware preparation and installation (e.g., pivots and arms) in dormakaba header		160
CMP SHEAR	Competitors Shear Lock, Magnetic Lock, Overhead Concealed Closer prep and install in dormakaba header		300
MITER	Miter cut charge		65
			Net Add \$

NOTES:

- For headers with RTS, specify 90° or 105°, HO or NHO, and spring size.
- Anodized headers are finished 4 sides, clad are finished 3 sides.
- Reference header accessories for cladding purchased separately.
- Default pivot location is 2-3/4" (70) centerline unless otherwise specified.
- Specify finished header length for any header above.
- End caps are optional and sold in sets of two (2) each.
- Headers requiring RTS preparation, less closers, deduct \$240 list per closer.

- Specify "LC" at the end of reference number. Example: 223.018.LC
- CMP Charges do not include cost of competitors product. Customer responsible to provide competitors products if pre-installation of competitors product is desired.
- When pairing a glass panic with a header, denote the jamb condition and clear opening width. When installed against a finished wall, pivot distance will change to 3-1/2".

- ① Non-Fabricated item, can ship in 1 business day through Select Service. Program, quantities limited.
- ③ Standard or Non-Standard Fabricated; lead time up to 3 business days.
- ⑤⑥ Special Fabricated/Finish or Special Order; lead time up to 5 weeks.

DRS Rails, Channels & Accessories
Patch Fittings & Designer Pivots
Offset Hung Patch Fittings
Headers & Accessories
Closers & Hardware
Locksets
Pulls & Handles
Sliding Systems
MANET
Panic Hardware

Header, Paired Opening

48" (1219) to 92" (2438)

Ref. #	U/M	Length	Description	101	700
Select Service Header, Paired less RTS				①	①
233.042.xxx.SS	Ea.	72" (1829)	4-1/2" (114)	326	574
Select Service Header, Paired with PT21				①	①
233.046.xxx.SS	Ea.	72" (1829)	4-1/2" (114)	352	578

Model	Ref. #	U/M	Description	Standard Finishes \$					Custom Finishes \$	
				101	108/109	113	503/599	600/601	700/701	199/399
POWDER	All Custom powder coated orders will include a net charge per purchase order.									200

Paired with 2-RTS88 (928.3xx) Installed, Flat Cover				Paired Header Base Price							
	233.020	Ea.	4-1/8" (105)	786	818	866	1,180	1,514	1,016	1,128	1,956
	233.042	Ea.	4-1/2" (114)	806	842	—	1,238	1,596	1,054	1,186	2,068
	233.061	Ea.	6" (152)	908	946	996	1,312	1,656	1,144	1,298	2,218

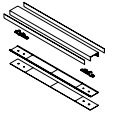
Paired with 2-PT21 (801.117) Installed, Flat Cover				Paired Header Base Price							
	233.038	Ea.	4-1/8" (105)	350	382	426	714	1,036	572	656	1,452
	233.046	Ea.	4-1/2" (114)	352	386	—	722	1,052	578	658	1,476
	233.065	Ea.	6" (152)	472	510	556	846	1,178	700	826	1,714

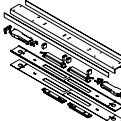
Paired with 2-RTS88 (928.3xx) and 2-Shear Locks (933.025) Installed, Shear Lock Header Cap				Paired Header Base Price							
	233.027	Ea.	4-1/8" (105)	3,960	3,994	4,086	4,474	4,820	4,282	4,346	5,374
	233.034	Ea.	4-1/2" (114)	3,986	4,024	—	4,544	4,918	4,326	4,482	5,488
	233.069	Ea.	6" (152)	4,082	4,122	4,216	4,606	4,962	4,410	4,516	5,636

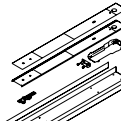
Paired with 1-RTS88 (928.3xx) and 1-PT21 (801.117) Installed, Flat Cover				Paired Header Base Price							
	233.019	Ea.	4-1/8" (105)	568	600	646	947	1,275	794	892	1,704
	233.041	Ea.	4-1/2" (114)	579	614	—	980	1,324	816	922	1,772
	233.062	Ea.	6" (152)	690	728	776	1,079	1,417	922	1,062	1,966

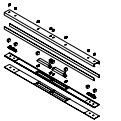
Paired with 2-PT21 (801.117) and 2-Shear Locks (933.025) Installed				Paired Header Base Price							
	233.024	Ea.	4-1/8" (105)	3,524	3,558	3,646	4,008	4,342	3,838	3,874	4,870
	233.045	Ea.	4-1/2" (114)	3,532	3,568	—	4,028	4,374	3,850	3,954	4,896
	233.063	Ea.	6" (152)	3,646	3,686	3,776	4,140	4,484	3,966	4,044	5,132

Header Options			List Add \$	
PANIC	Prep for Glass Panic/Deadbolt Push Bar Device in dormakaba header, manual strike.			80
HDWPREP	Prep and Install of non-standard dormakaba hardware (e.g., offset pivots, arms, etc.) in dormakaba header.			80
ELOCKPREP	Prep and install of magnetic and electronic locks (e.g. EMLs and EMSLs)			300
CMP HDWP	Competitor hardware component preparation only for dormakaba header (e.g., pivots and arms). Charge may be reviewed based on complexity.			95
CMP HDWI	Competitors hardware preparation and installation (e.g., pivots and arms) in dormakaba header			160
CMP SHEAR	Competitors Shear Lock, Magnetic Lock, Overhead Concealed Closer prep and install in dormakaba header			300
MITER	Miter cut charge			65
			Net Add \$	
POWDER	All Custom powder coated orders will include a net charge per purchase order.			200

NOTES:

- For headers with RTS, specify 90° or 105°, HO or NHO, and spring size.
- Anodized headers are finished 4 sides, clad are finished 3 sides.
- Reference header accessories for cladding purchased separately.
- Default pivot location is 2-3/4" (70) centerline unless otherwise specified.
- Specify finished header length for any header above.
- End caps are optional and sold in sets of two (2) each.
- Headers requiring RTS preparation, less closers, deduct \$240 list per closer.
- Specify "LC" at the end of reference number. Example: 223.018.LC
- CMP Charges do not include cost of competitors product. Customer

responsible to provide competitors products if pre-installation of competitors product is desired.

- When pairing a glass panic with a header, denote the jamb condition and clear opening width. When installed against a finished wall, pivot distance will change to 3-1/2".

- ① Non-Fabricated item, can ship in 1 business day through Select Service Program, quantities limited.
- ③ Standard or Non-Standard Fabricated; lead time up to 3 business days.
- Ⓢ Special Fabricated/Finish or Special Order; lead time up to 5 weeks.

Narrow Header with PT21, Single Opening

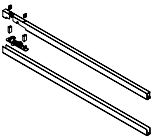
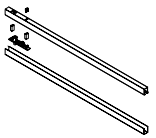
				Standard Finishes \$				
				101	109 only	700/701	399	299
Model	Ref. #	U/M	Description	5	SO	5/SO	Q	Q
Single with 1-PT21 (838.117) Installed, Flat Cover				Single Header Base Price				
	233.825	Ea.	1" (25) for 3/8"- 9/16" (10-15) glass widths	347	357	375	397	546
	233.821	Ea.	1.25" (32) for 5/8"- 13/16" (16-21) glass widths	347	357	375	397	546

DRS Rails, Channels & Accessories
Patch Fittings & Designer Pivots
Offset Hung Patch Fittings

Narrow Header with PT21, Paired Opening

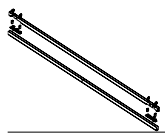
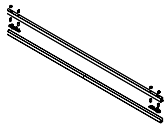
				Standard Finishes \$				
				101	109 only	700/701	399	299
Model	Ref. #	U/M	Description	5	SO	5/SO	Q	Q
Paired with 1-PT21 (838.117) Installed, Flat Cover				Paired Header Base Price				
	233.826	Ea.	1" (25) for 3/8"- 9/16" (10-15) glass widths	694	714	750	794	1,092
	233.822	Ea.	1.25" (32) for 5/8"- 13/16" (16-21) glass widths	694	714	750	794	1,092

Headers & Accessories
Closers & Hardware
Locksets
Pulls & Handles
Sliding Systems
MANET
Panic Hardware

MUNDUS PT21M Header, Single Opening

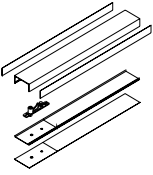
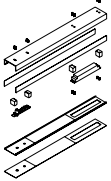
				Standard Finishes \$					Custom Finishes \$		
				101	108/109	113	503/599	600/601	700/701	199/399	299
Model	Ref. #	U/M	Description	3	3	3	(SO)	(SO)	3	(Q)	(Q)
Single with 1-PT21M (838.212) Installed, Flat Cover				Single Header Base Price							
	233.021	Ea.	4-1/8" (105)	175	191	213	357	518	286	328	726
	233.033	Ea.	4-1/2" (114)	176	193	—	361	526	289	329	738
	233.066	Ea.	6" (152)	236 (SO)	255 (SO)	278	423	589	350 (SO)	413	857
Single with 1-PT21M (838.212) and 1-Shear Lock (933.025) Installed											
	233.028	Ea.	4-1/8" (105)	1,762	1,779	1,823	2,004	2,171	1,919	1,937	2,435
	233.039	Ea.	4-1/2" (114)	1,766	1,784	—	2,014	2,187	1,925	1,977	2,448
	233.071	Ea.	6" (152)	1,823	1,843	1,888	2,070	2,242	1,983	2,022	2,566

MUNDUS PT21M Header, Paired Opening

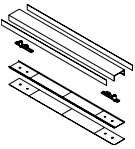
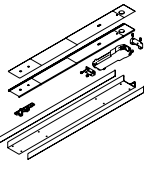
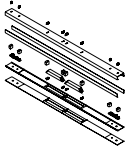
				Standard Finishes \$					Custom Finishes \$		
				101	108/109	113	503/599	600/601	700/701	199/399	299
Model	Ref. #	U/M	Description	3	3	3	(SO)	(SO)	3	(Q)	(Q)
Paired with 2-PT21M (838.212) Installed, Flat Cover				Paired Header Base Price							
	233.022	Ea.	4-1/8" (105)	350	382	426	714	1,036	572	656	1,452
	233.035	Ea.	4-1/2" (114)	352	386	—	722	1,052	578	658	1,476
	233.067	Ea.	6" (152)	472 (SO)	510 (SO)	556	846	1,178	700 (SO)	826	1,714
Paired with 1-RTS88 (928.3xx) and 1-PT21M (838.212) Installed, Flat Cover											
	233.026	Ea.	4-1/8" (105)	600	600	646	947	1,275	794	892	1,704
	233.037	Ea.	4-1/2" (114)	579	614	—	980	1,324	816	922	1,772
	233.070	Ea.	6" (152)	690 (SO)	728 (SO)	776	1,079	1,417	922 (SO)	1,062	1,966
Paired with 2-PT21M (838.212) and 2-Shear Locks (933.025) Installed											
	233.029	Ea.	4-1/8" (105)	3,524	3,558	3,646	4,008	4,342	3,838	3,874	4,870
	233.047	Ea.	4-1/2" (114)	3,532	3,568	—	4,028	4,374	3,850	3,954	4,896
	233.073	Ea.	6" (152)	3,646 (SO)	3,686 (SO)	3,776	4,140	4,484	3,966 (SO)	4,044	5,132

MUNDUS Narrow Header with PT21M, Single Opening

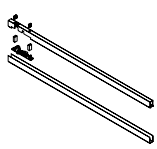
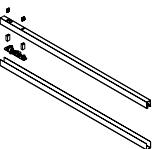
					Standard Finishes \$				
					101	109 only	700/701	399	299
Model	Ref. #	U/M	Description		Ⓟ	ⓈⓄ	Ⓟ/ⓈⓄ	Ⓠ	Ⓠ
Single with 1-PT21M (838.212) Installed, Flat Cover					Single Header Base Price				
	233.827	Ea.	1" (25) for 3/8"- 9/16" (10-15) glass widths		347	357	375	397	546
	233.823	Ea.	1.25" (32) for 5/8"- 13/16" (16-21) glass widths		347	357	375	397	546

MUNDUS Narrow Header with PT21M, Paired Opening

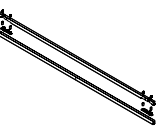
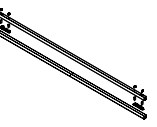
					Standard Finishes \$				
					101	109 only	700/701	399	299
Model	Ref. #	U/M	Description		Ⓟ	ⓈⓄ	Ⓟ/ⓈⓄ	Ⓠ	Ⓠ
Paired with 1-PT21M (838.212) Installed, Flat Cover					Paired Header Base Price				
	233.828	Ea.	1" (25) for 3/8"- 9/16" (10-15) glass widths		694	714	750	794	1,092
	233.824	Ea.	1.25" (32) for 5/8"- 13/16" (16-21) glass widths		694	714	750	794	1,092

DRS Rails, Channels & Accessories

Patch Fittings & Designer Pivots

Offset Hung Patch Fittings

Headers & Accessories

Closers & Hardware

Locksets

Pulls & Handles

Sliding Systems

MANET

Panic Hardware

Header Options

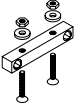
			Standard Finishes \$				Custom Finishes \$	
Header Stops			101	108/109	500/501	503/599	600/601/602	199/299/399
	233.989	Ea. Header Stop	23 ^①	23 ^①	52 ^①	52 ^①	52 ^⑩	69 ^⑩

RTS88 Options

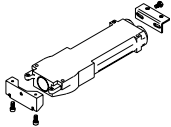

Model	Ref. #	U/M	Description	List Add \$
RTS88 Overhead Concealed Closer – Light Opening Force, Exterior Doors				③
	928.317	Ea.	105° HO BFE (5 mm Ext.)	259
	928.319	Ea.	105° NHO BFE (5 mm Ext.)	259
RTS88 Overhead Concealed Closer – Barrier Free (BFI) Interior Doors Only				
	928.321	Ea.	105° HO BFI (5 mm Ext.)	259
	928.323	Ea.	105° NHO BFI (5 mm Ext.)	259
RTS88 Overhead Concealed Closer – Hold Open Heavier Spring Sizes				
	928.329	Ea.	90° HO SZ 3 (5 mm Ext.)	259
	928.330	Ea.	105° HO SZ3 (5 mm Ext.)	259
RTS88 Overhead Concealed Closer – Non-Hold Open Heavier Spring Sizes				
	928.337	Ea.	105° NHO SZ 3 (5 mm Ext.)	259
	928.338	Ea.	90° NHO SZ3 (5 mm Ext.)	259

① Non-Fabricated item, can ship in 1 business day through Select Service Program, quantities limited.

③ Standard or Non-Standard Fabricated; lead time up to 3 business days.







NOTES:

- dormakaba requires the use of 5 mm Ext. spindles with all Herculite type door applications when supplied with RTS88 overhead concealed closers. This allows for optimum spindle engagement. Inadequate engagement can cause premature wear on the closers and hardware, voiding warranty.

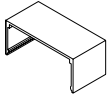
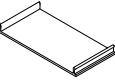
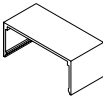
Optional Sidelite Headers

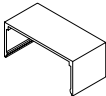
4-1/8" (105), 4-1/2" (114), and 6" (152) Wide × 1-3/4" (44)

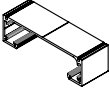
Sidelite Header Options

				Standard Finishes \$					Custom Finishes \$		
				101	108/109	113	503/599	600/601	700/701	199/399	299
	Ref. #	U/M	Description	3	3	3	SO	SO	3	Q	Q
Header with Flat Cover											
	233.700	Ft.	4-1/8" (105) Header with Flat Cover	16	20	25	48	61	29	55	82
			Q								
	233.705	Ft.	4-1/2" (114) Header with Flat Cover	18	22	—	54	69	32	63	92
	233.710	Ft.	6" (152) Header with Flat Cover	30	38	47	89	114	53	102	152
4-1/8" Header with Dri-Fit® (Includes gasket)											
	233.701	Ft.	4-1/8" (105) Header with 3/8" (10) Dri-Fit®	26	30	35	63	79	40	70	105
	233.702	Ft.	4-1/8" (105) Header with 1/2" (12) Dri-Fit®	26	30	35	63	79	40	70	105
	233.703	Ft.	4-1/8" (105) Header with 5/8" (15) Dri-Fit®	31	36	44	79	98	49	89	132
	233.704	Ft.	4-1/8" (105) Header with 3/4" (19) Dri-Fit®	31	36	44	79	98	49	89	132
4-1/2" Header with Dri-Fit® (Includes gasket)											
	233.706	Ft.	4-1/2" (114) Header with 3/8" (10) Dri-Fit®	30	34	—	76	94	47	86	126
	233.707	Ft.	4-1/2" (114) Header with 1/2" (12) Dri-Fit®	30	34	—	76	94	47	86	126
	233.708	Ft.	4-1/2" (114) Header with 5/8" (15) Dri-Fit®	33	38	—	85	106	52	97	142
	233.709	Ft.	4-1/2" (114) Header with 3/4" (19) Dri-Fit®	33	38	—	85	106	52	97	142
6" Header with Dri-Fit® (Includes gasket)											
	233.711	Ft.	6" (152) Header with 3/8" (10) Dri-Fit®	40	48	57	104	132	64	117	175
	233.712	Ft.	6" (152) Header with 1/2" (12) Dri-Fit®	40	48	57	104	132	64	117	175
	233.713	Ft.	6" (152) Header with 5/8" (15) Dri-Fit®	45	54	66	120	151	73	136	202
	233.714	Ft.	6" (152) Header with 3/4" (19) Dri-Fit®	45	54	66	120	151	73	136	202
										List Add \$	
MITER	Miter cut charge									65	
JAMB	Jamb prep charge includes blocking support if required. Allow up to 5 additional days lead-time.									65	
										Net Add \$	
POWDER	All Custom powder coated orders will include a net charge per purchase order.									200	





- 3 Standard or Non-Standard Fabricated; lead time up to 3 business days.
- SO Special Fabricated/Finish or Special Order; lead time up to 5 weeks.

NOTES:

- Must specify length when ordering. dormakaba will cut to specified size, priced per foot only.
- Maximum overall length 144" (3.66M) before requiring a splice joint; 120" (3M) for Brass and Bronze finishes.
- Above priced per foot for the combined parts defined.

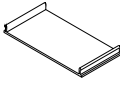
Header Accessories and Service Parts

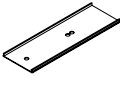
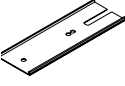
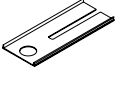
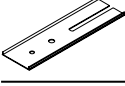
4-1/8" (105) Wide x 1-3/4" (44)

Ref. #	U/M	Description	Standard Finishes \$						Custom Finishes \$		
			101	108/109	113	503/599	600/601	700/701	199/399	299	
Header Tube, 4-1/8"											
	933.032	Ft.	4-1/8" (105) Header Tube, Anodized	11	13	16	—	—	—	36	—
	233.999	Ft.	4-1/8" (105) Header Tube with Clad on sides only	—	—	—	32	40	19	—	55
Header Flat Cover, 4-1/8"											
	933.030	Ft.	4-1/8" (105) Flat Cover, Anodized	5	7	9	—	—	—	19	—
	233.998	Ft.	4-1/8" (105) Flat Cover, with Clad on face only.	—	—	—	16	21	10	—	27
Floating Header Flat Cover											
	933.437	Ft.	6" (152) Floating Header Cover, Anodized	12	14	17	—	—	—	19	—
	233.891		4-1/8" (152) Floating Header Cover, with Clad on face only	—	—	—	26	24	22	—	36
Header Cover for RTS Adjustment, 4-1/8"											
	933.443	Ft.	4-1/8" (105) Cover for RTS Adjustment, Anodized	10	12	15	—	—	—	33	—
	233.892	Ft.	4-1/8" (105) Cover for RTS Adjustment, Clad on face only	—	—	—	28	36	16	—	49
Floating Header Cover for RTS Adjustment, 4-1/8"											
	933.447	Ft.	4-1/8" (105) Floating Header Cover for RTS Adjustment, Anodized	19	22	27	—	—	—	28	—
	233.894	Ft.	4-1/8" (105) Floating Header Cover for RTS Adjustment, Clad on face only	—	—	—	40	37	34	—	56
Floating Header Cover Caps, 4-1/8"											
	933.445	Ea.	4-1/8" (105) Floating RTS Cover Cap, Anodized	109	131	158	—	—	—	164	—
	233.893	Ea.	4-1/8" (105) Floating RTS Cover Cap, Clad on face only. Length is 3-15/16" (100mm)	—	—	—	240	218	196	—	327
	933.435	Ea.	4-1/8" (105) PT21 Cover Cap, Anodized	100	120	145	—	—	—	150	—
	233.890	Ea.	4-1/8" (105) PT21 Cover Cap, Clad on face only	—	—	—	220	201	181	—	301
Header Glazing Pocket/Cover, 4-1/8"											
	933.031	Ft.	3/8" (10) & 1/2" (12) glass	9	11	13	—	—	—	28	—
	233.997	Ft.	3/8" (10) & 1/2" (12) glass Clad on face only (Gasket Required)	—	—	—	25	33	15	—	44
	933.331	Ft.	5/8" (15) & 3/4" (19) glass	14	17	22	—	—	—	47	—
	233.986	Ft.	5/8" (15) & 3/4" (19) glass Clad on face only (Gasket Required)	—	—	—	41	52	24	—	71





- ③ Standard or Non-Standard Fabricated; lead time up to 3 business days.
- ⑤ Custom Fabricated; lead time up to 5 business days.
- SO Special Fabricated/Finish or Special Order; lead time up to 5 weeks.

NOTES:

- Must specify length when ordering header extrusions. dormakaba will cut to specified size, priced per foot only.
- Maximum overall length 144" (3.66M) before requiring a splice joint; 120" (3M) for Brass and Bronze finishes.

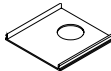
Header Accessories and Service Parts

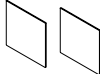
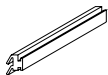
4-1/8" (105) Wide x 1-3/4" (44)

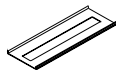
				Standard Finishes \$					Custom Finishes \$		
				101	108/109	113	503/599	600/601	700/701	199/399	299
Ref. #	U/M	Description		3	3	3	SO	SO	3	Q	Q
Header Cover Caps, 4-1/8"											
	933.029	Ea.	4-1/8" (105) RTS Cover Cap, Anodized	33	39	49	—	—	—	108	—
	233.996	Ea.	4-1/8" (105) RTS Cover Cap, Clad on face only. Length is 3-15/16" (100)	—	—	—	95	121	56	—	164
	933.505	Ea.	4-1/8" (105) PT21 Cover Cap, Anodized	28	34	43	—	—	—	94	—
	233.984	Ea.	4-1/8" (105) PT21 Cover Cap, Clad on Face Only. Length is 3-15/16"	—	—	—	82	105	48	—	142
Header End Cap				(109 only)				(399 only)			
	933.039	Ea.	4-1/8" (105) x 1-3/4" (44) Header End Cap, Anodized	20	24	29	—	—	—	64	—
	933.340	Ea.	4-1/8" (105) x 1-3/4" (44) Header End Cap, Clad	—	—	—	57	73	34	—	98
Floating Header End Cap				5	5				5		
	933.461	Pr.	1-13/16" (45) x 1-3/4" (44) Floating Header End Caps, Anodized	20	20	20	—	—	—	41	—
	933.464	Pr.	1-13/16" (45) x 1-3/4" (44) Floating Header End Caps, Clad	—	—	—	22	40	20	—	46
Dri-Fit® Gasket											
	925.148	Ft.	3/8" (10) & 5/8" (15) glass								1 3 (no finish options)
	925.147	Ft.	1/2" (12) & 3/4" (19) glass								1 3 (no finish options)
EMSL 2765 Shear Lock											
	933.025	Ea.	EMSL 2765 Shear Lock (Not Installed)								1,277 1 (no finish options)
EMSL Shear Lock Header Cap, 4-1/8"											
	933.021	Ea.	4-1/8" (105) Header Cap for Shear Lock, Anodized	10	11	33	—	—	—	32	—
	233.991	Ea.	4-1/8" (105) Header Cap for Shear Lock, Clad on face only. Length is 12-1/8" (308)	—	—	—	70	76	56	—	132

- ① Non-Fabricated item, ships in 1 business day.
- 3 Standard or Non-Standard Fabricated; lead time up to 3 business days.
- 5 Custom Fabricated; lead time up to 5 business days.
- SO Special Fabricated/Finish or Special Order; lead time up to 5 weeks.

NOTES

- Must specify length when ordering header extrusions. dormakaba will cut to specified size, priced per foot only.
- Maximum overall length 144" (3.66 m) before requiring a splice joint; 120" (3 m) for Brass and Bronze finishes.

DRS Rails, Channels & Accessories

Patch Fittings & Designer Pivots

Offset Hung Patch Fittings

Headers & Accessories

Closers & Hardware

Locksets

Pulls & Handles





Sliding Systems

MANET

Panic Hardware

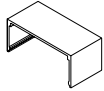
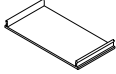
Header Accessories and Service Parts

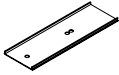
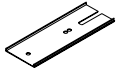
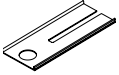
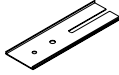
4-1/2" (114) Wide × 1-3/4" (44)

				Standard Finishes \$					Custom Finishes \$		
				101	108/109	113	503/599	600/601	700/701	199/399	299
	Ref. #	U/M	Description	3	3	3	SO	SO	3	Q	Q
Header Tube, 4-1/2"											
	933.033	Ft.	4-1/2" (114) Header Tube, Anodized	13	15	—	—	—	—	44	—
	233.995	Ft.	4-1/2" (114) Header Tube, with Clad on sides only	—	—	—	38	48	22	—	65
Header Flat Cover, 4-1/2"											
	933.034	Ft.	4-1/2" (114) Flat Cover, Anodized	5	7	—	—	—	—	19	—
	233.994	Ft.	4-1/2" (114) Flat Cover, with Clad on face only	—	—	—	16	21	10	—	27
Floating Header Flat Cover, 4-1/2"				5	5				5		
	933.441	Ft.	4-1/2" (114) Floating Header Cover, Anodized	12	14	—	—	—	—	39	—
	233.896	Ft.	4-1/2" (114) Floating Header Cover, with Clad on face only	—	—	—	35	45	21	—	60
Header Cover for RTS Adjustment, 4-1/2"				3	3				3		
	933.428	Ft.	4-1/2" (114) RTS Adjustment Cover, Anodized	19	22	—	—	—	—	61	—
	233.897	Ft.	4-1/2" (114) RTS Adjustment Cover, Clad on face only	—	—	—	53	69	32	—	93
Floating Header Cover for RTS Adjustment, 4-1/2"				5	5				5		
	933.430	Ft.	4-1/2" (114) Floating Header Cover for RTS Adjustment, Anodized	19	22	—	—	—	—	28	—
	233.899	Ft.	4-1/2" (114) Floating Header Cover for RTS Adjustment, Clad on face only	—	—	—	40	37	34	—	56
Floating Header Cover Cap, 4-1/2"											
	933.449	Ea.	4-1/2" (114) Floating RTS Cover Cap, Anodized	109	131	—	—	—	—	164	—
	233.898	Ea.	4-1/2" (114) Floating RTS Cover Cap, Clad on face only	—	—	—	240	218	196	—	327
	933.439	Ea.	4-1/2" (114) Floating PT21 Cover Cap, Anodized	121	145	—	—	—	—	399	—
	233.895	Ea.	4-1/2" (114) Floating PT21 Cover Cap, Clad on face only	—	—	—	351	448	206	—	605
Header Glazing Pocket/Cover, 4-1/2"				3	3				3		
	933.035	Ft.	3/8" (10) & 1/2" (12) glass	11	13	—	—	—	—	36	—
	233.993	Ft.	3/8" (10) & 1/2" (12) glass Clad on face only (Gasket Required)	—	—	—	32	40	19	—	55
	933.335	Ft.	5/8" (15) & 3/4" (19) glass	14	17	—	—	—	—	47	—
	233.985	Ft.	5/8" (15) & 3/4" (19) glass Clad on face only (Gasket Required)	—	—	—	41	52	24	—	71





- 3 Standard or Non-Standard Fabricated; lead time up to 3 business days.
- 5 Custom Fabricated; lead time up to 5 business days.
- SO Special Fabricated/Finish or Special Order; lead time up to 5 weeks.

NOTES:

- Must specify length when ordering header extrusions. dormakaba will cut to specified size, priced per foot only.
- Maximum overall length 144" (3.66 m) before requiring a splice joint; 120" (3 m) for Brass and Bronze finishes.
- Please note, 6" (152) header channel utilizes inserts from 4-1/8" (105) header design.

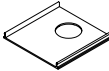
Header Accessories and Service Parts

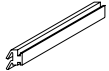
4-1/2" (114) Wide x 1-3/4" (44)

	Ref. #	U/M	Description	Standard Finishes \$						Custom Finishes \$	
				101	108/109	113	503/599	600/601	700/701	199/399	299
Header Cover Cap, 4-1/2"				3	3	3	SO	SO	3	Q	Q
	933.036	Ea.	4-1/2" (114) RTS Cover Cap, Anodized	33	39	—	—	—	—	108	—
	233.992	Ea.	4-1/2" (114) RTS Cover Cap, Clad on face only. Length is 3-15/16" (100)	—	—	—	95	121	56	—	164
	933.555	Ea.	4-1/2" (114) PT21 Cover Cap, Anodized	28	34	—	—	—	—	94	—
	233.988	Ea.	4-1/2" (114) PT21 Cover Cap, Clad on Face Only. Length is 3-15/16"	—	—	—	82	105	48	—	142
Header End Cap, 4-1/2"				(109 only)						(399 only)	
	933.040	Ea.	4-1/2" (114) x 1-3/4" (44) Header End Cap, Anodized	20	20	—	—	—	—	35	—
	933.341	Ea.	4-1/2" (114) x 1-3/4" (44) Header End Cap, Clad	—	—	—	22	40	20	—	46
Floating Header End Caps, 4-1/2"				5	5				5		
	933.462	Pr.	2" (50) x 1-3/4" (44) Floating Header End Caps, Anodized	20	20	—	—	—	—	35	—
	933.465	Pr.	2" (50) x 1-3/4" (44) Floating Header End Caps, Clad	—	—	—	22	40	20	—	46
Dri-Fit® Gasket											
	925.148	Ft.	3/8" (10) & 5/8" (15) glass		1	3	(no finish options)				
	925.147	Ft.	1/2" (12) & 3/4" (19) glass		1	3	(no finish options)				
EMSL 2765 Shear Lock											
	933.025	Ea.	EMSL 2765 Shear Lock (Not Installed)		1,277	1	(no finish options)				
	EMSL Shear Lock Header Cap, 4-1/2"				5	5		SO	SO	5	SO
	933.037	Ea.	4-1/2" (114) Header Cap for Shear Lock, Anodized	13	14	—	—	—	—	71	—
	233.990	Ea.	4-1/2" (114) Header Cap for Shear Lock, Clad on face only. Length is 12-1/8" (308).	—	—	—	76	84	59	—	133

- ① Non-Fabricated item, ships in 1 business day.
- Standard or Non-Standard Fabricated; lead time up to 3 business days.
- ⑤ Custom Fabricated; lead time up to 5 business days.
- SO Special Fabricated/Finish or Special Order; lead time up to 5 weeks.

NOTES:

- Must specify length when ordering header extrusions. dormakaba will cut to specified size, priced per foot only.
- Maximum overall length 144" (3.66M) before requiring a splice joint; 120" (3 m) for Brass and Bronze finishes.
- Please note, 6" (152) header channel utilizes inserts from 4-1/8" (105) header design.

DRS Rails, Channels & Accessories

Patch Fittings & Designer Pivots

Offset Hung Patch Fittings

Headers & Accessories

Closers & Hardware

Locksets

Pulls & Handles







Sliding Systems

MANET

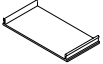
Panic Hardware

Header Accessories and Service Parts

6" (152) Wide × 1-3/4" (44) 437

Ref. #	U/M	Description	Standard Finishes \$						Custom Finishes \$		
			101	108/109	113	503/599	600/601	700/701	199/399	299	
			3	3	3	SO	SO	3	Q	Q	
Header Tube, 6"											
	933.432	Ft.	6" (152) Header Tube, Anodized	25	31	38	—	—	—	83	—
	233.987	Ft.	6" (152) Header Tube, Clad on sides only	—	—	—	73	93	43	—	125
Header Flat Cover, (6" and 4-1/8")											
	933.030	Ft.	6" (152) & 4-1/8" (105) Flat Cover, Anodized	5	7	9	—	—	—	19	—
	233.998	Ft.	6" (152) & 4-1/8" (105) Flat Cover, with Clad on face only.	—	—	—	16	21	10	—	27
Floating Header Flat Cover, (6" and 4-1/8")											
	933.437	Ft.	6" (152) & 4-1/8" (105) Floating Header Cover, Anodized	12	14	17	—	—	—	19	—
	233.891	Ft.	4-1/8" (105) Floating Header Cover, with Clad on face only.	—	—	—	26	24	22	—	36
Header Cover for RTS Adjustment, (6" and 4-1/8")											
	933.443	Ft.	6" (152) & 4-1/8" (105) Cover for RTS Adjustment, Anodized	10	12	15	—	—	—	33	—
	233.892	Ft.	6" (152) & 4-1/8" (105) Cover for RTS Adjustment, with Clad on face only.	—	—	—	28	36	16	—	49
Floating Header Cover for RTS Adjustment, (6" and 4-1/8")											
	933.447	Ft.	6" (152) & 4-1/8" (105) Floating Header Cover for RTS Adjustment, Anodized	19	22	27	—	—	—	28	—
	233.894	Ft.	6" (152) & 4-1/8" (105) Floating Header Cover for RTS Adjustment, Clad on face only	—	—	—	40	37	34	—	56
Floating Header Cover Caps, (6" and 4-1/8")											
	933.445	Ea.	6" (152) & 4-1/8" (105) Floating RTS Cover Cap, Anodized	109	131	158	—	—	—	164	—
	233.893	Ea.	6" (152) & 4-1/8" (105) Floating RTS Cover Cap, Clad on face only. Length is 3-15/16" (100)	—	—	—	240	218	196	—	327
	933.435	Ea.	6" (152) & 4-1/8" (105) PT21 Cover Cap, Anodized	100	120	145	—	—	—	150	—
	233.890	Ea.	6" (152) & 4-1/8" (105) PT21 Cover Cap, Clad on face only	—	—	—	220	201	181	—	301
Header Glazing Pocket/Cover, (6" and 4-1/8")											
	933.031	Ft.	3/8" (10) & 1/2" (12) glass	9	11	13	—	—	—	28	—
	233.997	Ft.	3/8" (10) & 1/2" (12) glass Clad on face only (Gasket Required)	—	—	—	25	33	15	—	44
	933.331	Ft.	5/8" (15) & 3/4" (19) glass	14	17	22	—	—	—	47	—
	233.986	Ft.	5/8" (15) & 3/4" (19) glass Clad on face only (Gasket Required)	—	—	—	41	52	24	—	71







- 3 Standard or Non-Standard Fabricated; lead time up to 3 business days.
- 5 Custom Fabricated; lead time up to 5 business days.
- SO Special Fabricated/Finish or Special Order; lead time up to 5 weeks.

NOTES:

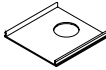
- Must specify length when ordering header extrusions. dormakaba will cut to specified size, priced per foot only.
- Maximum overall length 144" (3.66M) before requiring a splice joint; 120" (3M) for Brass and Bronze finishes.
- Please note, 6" (152) header channel utilizes inserts from 4-1/8" (105) header design.

Header Accessories and Service Parts

6" (152) Wide x 1-3/4" (44)

			Standard Finishes \$					Custom Finishes \$		
			101	108/109	113	503/599	600/601	700/701	199/399	299
Ref. #	U/M	Description	3	3	3	SO	SO	3	Q	Q
Header Cover Caps, (6" and 4-1/8")										
	933.029	Ea. 6" (152) & 4-1/8" (105) RTS Cover Cap, Anodized	33	39	49	—	—	—	108	—
	233.996	Ea. 6" (152) & 4-1/8" (105) RTS Cover Cap, Clad on face only. Length is 3-15/16" (100)	—	—	—	95	121	56	—	164
	933.505	Ea. PT21 Cover Cap, Anodized	28	34	43	—	—	—	94	—
	233.984	Ea. PT21 Cover Cap, Clad on Face Only. Length is 3-15/16" (100)	—	—	—	82	105	48	—	142
Header End Cap			(109 only)					(399 only)		
	933.467	Ea. 6" (152) x 1-3/4" (44) Header End Cap, Anodized	20	20	20	—	—	—	49	—
	933.468	Ea. 6" (152) x 1-3/4" (44) Header End Cap, Clad	—	—	—	22	40	20	—	57
Floating Header End Cap			5	5				5		
	933.463	Pr. 2-3/4" (69) x 1-3/4" (44) Floating Header End Caps, Anodized	20	20	20	—	—	—	49	—
	933.466	Pr. 2-3/4" (69mm) x 1-3/4" (44) Floating Header End Caps, Clad	—	—	—	22	40	20	—	57
Dri-Fit® Gasket										
	925.148	Ft. 3/8" (10) & 5/8" (15) glass		13		(no finish options)				
	925.147	Ft. 1/2" (12) & 3/4" (19) glass		13		(no finish options)				
EMSL 2765 Shear Lock										
	933.025	Ea. EMSL 2765 Shear Lock (Not Installed)		1,277	1	(no finish options)				
EMSL Shear Lock Header Cap, (6" and 4-1/8")			5	5		SO	SO	5	SO	SO
	933.021	Ea. 6" (152) & 4-1/8" (105) Header Cap for Shear Lock, Anodized.	10	11	33	—	—	—	32	—
	233.991	Ea. 6" (152) & 4-1/8" (105) Header Cap for Shear Lock, Clad on face only. Length is 12-1/8" (308)	—	—	—	70	76	56	—	132

- 3 Standard or Non-Standard Fabricated; lead time up to 3 business days.
- 5 Custom Fabricated; lead time up to 5 business days.
- SO Special Fabricated/Finish or Special Order; lead time up to 5 weeks.

NOTES:

- Must specify length when ordering header extrusions. dormakaba will cut to specified size, priced per foot only.
- Maximum overall length 144" (3.66M) before requiring a splice joint; 120" (3M) for Brass and Bronze finishes.
- Please note, 6" (152) header channel utilizes inserts from 4-1/8" (105) header design.

DRS Rails, Channels & Accessories

Patch Fittings & Designer Pivots

Offset Hung Patch Fittings

Headers & Accessories

Closers & Hardware

Locksets

Pulls & Handles

Sliding Systems

MANET

Panic Hardware

Floating Header for All-Glass Entrances with Transom

Ordering Guide

		Door Width Specify — Specify Width		Header Width 1-3/4" x 4-1/8" — 4-1/8 1-3/4" x 4-1/2" — 4-1/2 1-3/4" x 6" — 6		Doors/Panels 2D/SFH — 2 Door, Semi-Floating Header 2D/FFH — 2 Door, Full Floating Header 1D/SFH — 1 Door, Semi-Floating Header 1D/FFH — 1 Door, Full Floating Header	
FHDR				4-1/8	1D/FFH	1/2	continued below
FHDR Model		Specify NONE	Specify Header Length			1/2 3/8 5/8 3/4	Glass Thickness
	Hardware PT21 RTS88-5MM		Paired Hardware PT21M PT21 RTS88-5MM		Hold/Non-Hold Open NHO HO	Closer Spring Size SZ2 SZ4 BFE BFI SZ3	
101	RTS88-5MM	Y		105	NHO	SZ3	
101	— Clear Anodized (CL)	Y		105			
108	— Dark Bronze (DB)	N		90			
109	— Black Anodized (BK)		Standard Spindle Location		Closer Bumper Position		
503	— Polished Brass w/o Lacquer (PB)						
599	— Satin Brass w/o Lacquer (SB)						
600	— Satin Bronze w/o Lacquer (SBZ)						
601	— Polished Bronzed w/o Lacquer (PB2)						
700	— Satin Stainless Steel (SS/US32D)						
701	— Polished Stainless Steel (PS/US32)						

Standard Finish

- 113** — Similar to Satin Stainless (Limited Availability)
- 199** — Custom Anodized Finishes (Specify)
- 299** — Custom Cladding (Specify)
- 399** — Powder Coated Finishes (Specify)

1 dormakaba reserves the right to refuse Custom Finishes.

2 All Custom Finishes require customer sign-off/approval of color chip.

Finish Custom ^{1,2}

Floating Header, Single Opening

24" (610) to 48" (1219)



				Standard Finishes \$					Custom Finishes \$		
				101	108/109	113	503/599	600/601	700/701	199/399	299
Model	Ref. #	U/M	Description	(S)	(S)	(S)	(SO)	(SO)	(S)	(Q)	(Q)
Single Floating Header with 1-RTS88 (928.3xx) Installed				Single Header Base Price							
	233.418	Ea.	4-1/8" (105)	766	807	866	1,044	1,131	969	989	1,442
	233.440	Ea.	4-1/2" (114)	776	818	—	1,083	1,210	978	1,063	1,535
	233.640	Ea.	6" (152)	1,041	1,091	—	1,323	1,415	1,247	1,373	1,787
Single Floating Header with 1-PT21 (801.117) Installed											
	233.436	Ea.	4-1/8" (105)	542	580	635	802	893	734	758	1,188
	233.444	Ea.	4-1/2" (114)	573	616	—	981	1,240	767	1,101	1,609
	233.644	Ea.	6" (152)	817	864	—	1,081	1,177	1,012	1,142	1,533

Floating Header, Paired Opening

48" (1219) to 96" (2438)



				Standard Finishes \$					Custom Finishes \$		
				101	108/109	113	503/599	600/601	700/701	199/399	299
Model	Ref. #	U/M	Description	(S)	(S)	(S)	(SO)	(SO)	(S)	(Q)	(Q)
Paired Floating Header with 2-RTS88 (928.3xx) Installed				Paired Header Base Price							
	233.420	Ea.	4-1/8" (105)	1,532	1,614	1,732	2,088	2,262	1,938	1,978	2,884
	233.442	Ea.	4-1/2" (114)	1,552	1,636	—	2,166	2,420	1,956	2,126	3,070
	233.642	Ea.	6" (152)	2,082	2,182	—	2,646	2,830	2,494	2,746	3,574
Paired Floating Header with 2-PT21 (801.117) Installed											
	233.438	Ea.	4-1/8" (105)	1,084	1,160	1,270	1,604	1,786	1,468	1,516	2,376
	233.446	Ea.	4-1/2" (114)	1,146	1,232	—	1,962	2,480	1,534	2,202	3,218
	233.646	Ea.	6" (152)	1,634	1,728	—	2,162	2,354	2,024	2,284	3,066
Paired Floating Header with 1-RTS88 (928.3xx) and 1-PT21 (801.117) Installed											
	233.437	Ea.	4-1/8" (105)	1,308	1,387	1,501	1,846	2,024	1,703	1,747	2,630
	233.445	Ea.	4-1/2" (114)	1,349	1,434	—	2,064	2,450	1,745	2,164	3,144
	233.645	Ea.	6" (152)	1,858	1,955	—	2,404	2,592	2,259	2,515	3,320
Header Options											List Add \$
PANIC	Prep for Glass Panic/Deadbolt Push Bar Device in dormakaba header, manual strike.										80
HDWPREP	Prep. and Install of non-standard dormakaba hardware (e.g., offset pivots, arms, etc.) in dormakaba header.										95
ELOCKPREP	Prep and install of magnetic and electronic locks (e.g. EMLs and EMSLs)										300
CMP HDWP	Competitor hardware component preparation only for dormakaba header (e.g., pivots and arms). Charge may be reviewed based on complexity.										95
CMP HDWI	Competitors hardware preparation and installation (e.g., pivots and arms) in dormakaba header										160
CMP SHEAR	Competitors Shear Lock, Magnetic Lock, Overhead Concealed Closer prep and install in dormakaba header										300
											Net Add \$
POWDER	All Custom powder coated orders will include a net charge per purchase order.										200

DRS Rails, Channels & Accessories
Patch Fittings & Designer Pivots
Offset Hung Patch Fittings
Headers & Accessories
Closers & Hardware
Locksets
Pulls & Handles
Sliding Systems
MANET
Panic Hardware

Floating Header with PT21M, Single Opening

24" (610) to 48" (1219)

				Standard Finishes \$						Custom Finishes \$	
				101	108/109	113	503/599	600/601	700/701	199/399	299
Model	Ref. #	U/M	Description	(5)	(5)	(5)	(SO)	(SO)	(5)	(Q)	(Q)
Single Floating Header with 1-PT21M (838.212) Installed						Single Header Base Price					
	233.433	Ea.	4-1/8" (105)	542	580	635	802	893	734	758	1,188
	233.447	Ea.	4-1/2" (114)	573	616	—	981	1,240	767	1,101	1,609
	233.647	Ea.	6" (152)	817	864	—	1,081	1,177	1,012	1,142	1,533

Floating Header with PT21M, Paired Opening

48" (1219) to 96" (2438)

				Standard Finishes \$						Custom Finishes \$	
				101	108/109	113	503/599	600/601	700/701	199/399	299
Model	Ref. #	U/M	Description	(5)	(5)	(5)	(SO)	(SO)	(5)	(Q)	(Q)
Paired Floating Header with 2-PT21M (838.212) Installed						Paired Header Base Price					
	233.435	Ea.	4-1/8" (105)	1,084	1,160	1,270	1,604	1,786	1,468	1,516	2,376
	233.449	Ea.	4-1/2" (114)	1,146	1,232	—	1,962	2,480	1,534	2,202	3,218
	233.649	Ea.	6" (152)	1,634	1,728	—	2,162	2,354	2,024	2,284	3,066
Paired Floating Header with 1-RTS88 (928.3xx) and 1-PT21M (838.212) Installed											
	233.434	Ea.	4-1/8" (105)	1,308	1,387	1,501	1,846	2,024	1,703	1,747	2,630
	233.448	Ea.	4-1/2" (114)	1,349	1,434	—	2,064	2,450	1,745	2,164	3,144
	233.648	Ea.	6" (152)	1,858	1,955	—	2,404	2,592	2,259	2,515	3,320
Header Options											List Add \$
PANIC	Prep for Glass Panic/Deadbolt Push Bar Device in dormakaba header, manual strike.										80
HDWPREP	Prep. and install of non-standard dormakaba hardware (e.g., offset pivots, arms, etc.) in dormakaba header.										95
ELOCKPREP	Prep and install of magnetic and electronic locks (e.g. EMLs and EMSLs)										300
CMP HDWP	Competitor hardware component preparation only for dormakaba header (e.g., pivots and arms). Charge may be reviewed based on complexity.										95
CMP HDWI	Competitors hardware preparation and installation (e.g., pivots and arms) in dormakaba header										160
CMP SHEAR	Competitors Shear Lock, Magnetic Lock, Overhead Concealed Closer prep and install in dormakaba header										300
											Net Add \$
POWDER	All Custom powder coated orders will include a net charge per purchase order.										200

- (5) Custom Fabricated; lead time up to 5 business days.
- (SO) Special Fabricated/Finish or Special Order; lead time up to 5 weeks.

NOTES

- Must specify length when ordering. dormakaba will cut to specified size, priced per foot only.
- Maximum overall length 144" (3.66 m) before requiring a splice joint; 120" (3 m) for Brass and Bronze finishes.
- For floating Header with RTS, specify 90° or 105°, HO or NHO, and spring size.
- Headers requiring RTS preparation, less closers, deduct \$240 list per closer.
- Specify "LC" at the end of reference number. Example: 233.420.LC

Closers and Hardware

	Select Service	92
RTS88	Overhead Concealed Closers and Covers	95
	Closer and Pivot Hardware	96
BTS	BTS Floor Closers	100
	BTS Hardware	104
Hardware	Shear Locks	106
	Electromagnetic Locks	106
	Locks and Cylinders	107
	Strikes, Saddles, and Thresholds	108

DRS Rails,
Channels &
Accessories

Patch Fittings
& Designer
Pivots

Offset
Hung Patch
Fittings

Headers &
Accessories

Closers &
Hardware

Locksets

Pulls &
Handles

Sliding
Systems

MANET

Panic
Hardware

Select Service Quick Ship – Closers and Hardware

Select service should be used for small quantities of popular dormakaba products that require shipment within 24 hours. The program includes patch fittings, DRS rails, headers, concealed closers and pivots, and pulls and handles. Warehouses have been set up in the east and west for faster delivery nationwide. (Customer responsible for shipping costs FOB.)

Subject to Availability





Next Business Day Service (Shipment when Purchase Order is received prior to 4:00 PM EST).

Examples: dormakaba receives P.O. at 3:59 PM on Monday, order will ship by close of business on Tuesday.
 dormakaba receives P.O. at 3:59 PM on Friday, order will ship by close of business on the following Monday.

Notes:

- Standard freight and discount schedules and terms of sale apply. Please refer to the current price list for full details.
- dormakaba reserves the right to limit quantities or decline an order if the credit status of the buyer is not satisfactory to dormakaba.
- Orders cannot be cancelled.
- Select Service Quick Ship available only in the United States.
- All prices are in U.S. dollars.
- Products and prices are subject to change without notice.
- Limited quantities available.

Key

	"New" to Select Service, Available in East and West Coast Warehouse
	Available in East and West Coast Warehouse
	Available only in East Coast Warehouse
	Available only in West Coast Warehouse

Closers and Hardware

RTS Series

Ref. #	Warehouse	Package	Spring	Stop	NHO/HO	Extension	List \$
928.037.000.SS	■	RTS88	SZ3	105°	NHO	5 mm	259
928.030.000.SS	■	RTS88	SZ3	105°	HO	5 mm	259
928.038.000.SS	■	RTS88	SZ3	90°	NHO	5 mm	259
928.029.000.SS	■	RTS88	SZ3	90°	HO	5 mm	259
928.023.000.SS	■	RTS88	BFI	105°	NHO	5 mm	259
928.021.000.SS	■	RTS88	BFI	105°	HO	5 mm	259

RTS Accessories and Service Items

Ref. #	Warehouse	Model	Description	Finish	List \$
33600011	☐	CRNR BRKT	Header to side Jamb	—	6
928.002.000.SS	☐	8835	End load arm, 1" web	—	64
928.006.000.SS	☐	8836	End load arm, 7/8" web	—	58
928.004.000.SS	☐	8837	End load arm, 5/8" web	—	64
928.003.000.SS	☐	8838	End load arm, 3/4" web	—	64
928.009.000.SS	■	8812	Offset arm	—	87
928.055.000.SS	■	8852	Short floor pivot	—	46
928.056.000.SS	☐	8853	Tall floor pivot	—	56
928.053.500.SS	☐	8575	Cover, steel	500	120
928.053.689.SS	☐	8563	Cover, aluminum	101	50
928.063.000.SS	☐	* 8521E	2-5/16" (Add-On) spindle extension	—	42

* dormakaba recommends never combining RTS88 size BFI, BFE, or SZ2 closer with 8521E add-on extended spindle. These closers may not generate enough power to close and latch a door if used in combination with 8521E.

- DRS Rails, Channels & Accessories
- Patch Fittings & Designer Pivots
- Offset Hung Patch Fittings
- Headers & Accessories
- Closers & Hardware
- Locksets
- Pulls & Handles
- Sliding Systems
- MANET
- Panic Hardware

BTS Accessories and Service Items

Ref. #	Warehouse	Product	Hand	Finish	List \$
927.019.000.SS	■	BTS80 Sz. 3 (was BFE)	—	—	676
927.020.000.SS	■	BTS80 Sz. 4 (was STD)	—	—	676
927.021.000.SS	■	BTS80 Sz. 6 (was STRONG)	—	—	676
927.018.000.SS	■	BTS75V NHO 1-4	—	—	631
927.017.000.SS	■	BTS75V BF NHO 1-4	—	—	631
927.014.000.SS	■	BTS75V 90 HO 1-4	—	—	653
927.091.000.SS	■	74003 (spindle insert) 5/16" Clearance	—	—	51
927.092.000.SS	■	74005 (spindle insert) 1/2" Clearance	—	—	51
927.093.000.SS	☐	74007 (spindle insert) 5/8" Clearance	—	—	51
927.094.000.SS	■	74010 (spindle insert) 3/4" Clearance	—	—	51
927.096.000.SS	☐	74015 (spindle insert) 7/8" Clearance	—	—	64
927.097.000.SS	☐	74020 (spindle insert) 1-1/8" Clearance	—	—	64
227.003.700.SS	■	7410 (BTS80 cover plate)	—	700	109
227.003.602.SS	☐	7410 (BTS80 cover plate)	—	602	109
927.043.700.SS	■	7510 (BTS75V cover plate)	—	700	104
927.043.602.SS	☐	7510 (BTS75V cover plate)	—	602	104

Overhead Concealed Closers and Covers

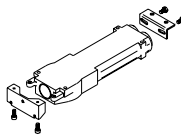
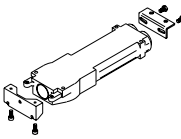
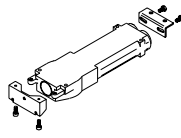
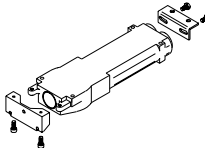
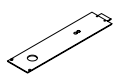
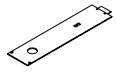
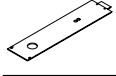
	Ref. #	U/M	Description	List \$
RTS88 Closers — Barrier Free Exterior (BFE)				
	928.017	Ea.	105° HO (5 mm ext.)*	259 ^①
	928.019	Ea.	105° NHO (5 mm ext.)*	259 ^①
RTS88 Closers — Barrier Free Interior (BFI)				
	928.021	Ea.	105° HO (5 mm ext.)*	259 ^①
	928.023	Ea.	105° NHO (5 mm ext.)*	259 ^①
	928.022	Ea.	105° NHO	259 ^①
RTS88 Closers — Hold Open				
	928.029	Ea.	90° (5 mm ext.) Size 3*	259 ^①
	928.030	Ea.	105° (5 mm ext.) Size 3*	259 ^①
	928.025	Ea.	105° Size 3	259 ^①
	928.027	Ea.	90° Size 3	259 ^①
RTS88 Closers — No Hold Open				
	928.037	Ea.	105° (5 mm ext.) Size 3*	259 ^①
	928.038	Ea.	90° (5 mm ext.) Size 3*	259 ^①
	928.032	Ea.	105° Size 3	259 ^①
	928.035	Ea.	90° Size 3	259 ^①
				Finishes \$
RTS88 Closers Covers**				
				101 108 600/601 500/501
	Model			(SO) (SO) (SO) (SO)
	8561	928.051	Ea. Cover when installed in Wood Header	50 50 — 120
	8563	928.052	Ea. Cover when installed in Aluminum Header	50 50 — —
	8575	928.053	Ea. Cover when installed in Steel Header	50 50 120 120

① Non-Fabricated item, ships in 1 business day
 ⑤ Non-Fabricated item, ships in 5 business days
 ⑥ Special Fabricated/Finish or Special Order; lead time up to 5 weeks.



NOTE:
 * dormakaba Glass requires the use of 5 mm extended spindles with ALL Herculite glass door applications when an OHCC is specified. This allows for optimum spindle bite. Inadequate bite can cause premature wear on the closers and hardware, potentially voiding warranty. Spring sizes other than what is listed above are available—please consult factory.

** Always use an auxillary stop in conjunction with RTS88 installations.

DRS Rails, Channels & Accessories
 Patch Fittings & Designer Pivots
 Offset Hung Patch Fittings
 Headers & Accessories
 Closers & Hardware
 Locksets
 Pulls & Handles
 Sliding Systems
 MANET
 Panic Hardware

Closer and Pivot Hardware

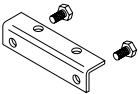

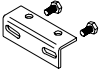
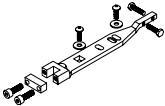
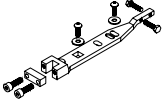
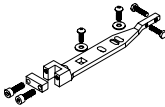
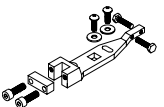
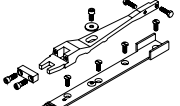
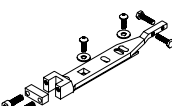
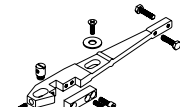
Brackets and Arms

Model	Ref. #	U/M	Description	Finishes \$
Brackets				101
				①
	928.012	Ea.	Round Angle Bracket (screws not included)	3
	928.997	Ea.	Screw Package	1
	928.013	Ea.	Corner Bracket	6
	928.999	Ea.	Screw Package	1
	928.014	Ea.	Slotted Angle Bracket (screws not included)	4
	928.997	Ea.	Screw Package	1
Top Arms				100/101
	8837	928.004	Ea. Rail Top Arm End Load 5/8" (16) web depth	64 ⑤
	8838	928.003	Ea. Rail Top Arm End Load 3/4" (19) web depth	64 ①
	8836	928.006	Ea. Rail Top Arm End Load 7/8" (22) web depth	58 ①
	8836S	928.001	Ea. Rail Short Top Arm End Load 7/8" (22) web depth	93 ⑥
	8534	228.001	Ea. Rail Top Arm End Load 7/8" (22) web depth	64 ⑥
	8835	928.002	Ea. Rail Top Arm End Load 1" (25) web depth	64 ⑥
	8831	928.007	Ea. Rail Top Arm Side Load 1/2" (13) web depth	64 ⑥

① Non-Fabricated item, ships in 1 business day
 ⑤ Non-Fabricated item, ships in 5 business days
 ⑥ Special Fabricated/Finish or Special Order; lead time up to 5 weeks.

Closer and Pivot Hardware

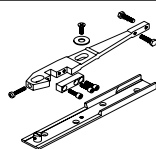
Arms and Pivots

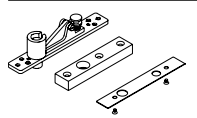
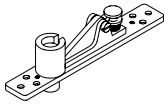
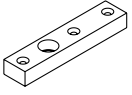
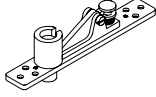
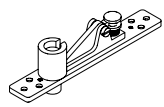
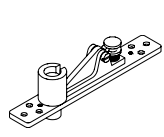
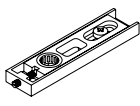
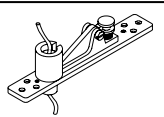
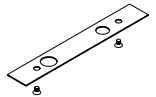
	Model	Ref. #	U/M	Description	Finishes \$			
Top Arms					100			
	8832	928.008	Ea.	Rail Top Arm Side Load 5/8" (16) web depth	146	(SO)		
	8812	928.009	Ea.	Rail Top Slide Arm 3/4" (19) Offset 3/4" (19) web depth	87	(S)		
Top Pivots					101	700/701		
	HD8062	927.066	Ea.	Walking Beam Pivot with 5/8" (16) Pin Complete Heavy Duty	229	(SO)	229	(SO)
	HD8062 TOP	927.065	Ea.	Top Walking Beam Pivot with 5/8" (16) Pin (HD)	104	(S)		
	HD8062 LOWER	927.050	Ea.	Top Walking Beam Pivot Door Portion (5/8" (16) Pin)	95	(S)		
	8062.5	927.063	Ea.	Top Walking Beam Pivot with 1/2" (13) Pin (Used for custom 1/2" (13) Receiver (Bearing) applications)	54	(S)		
	8062	927.064	Ea.	Top Walking Beam Pivot with 19/32" (15) Pin (Do not use with 355.0, 355.9, or 319.2 inserts) Use with 927.062 Lower.	48	(1)		
	PT21	801.117	Ea.	Top Walking Beam Pivot for use with inserts (Stan- dard Glass WBP) 355.0, 355.9, and 319.2 (904.610, 904.091, and 903.111 respectively)	51	(1)		
	8062 LOWER	927.062	Ea.	Top Walking Beam Pivot Door Portion (15 mm Pin) use with 8062 (Use with 927.065)	29	(1)		
					108	500/501	599	
	E8062	927.061	Ea.	Top Walking Beam Pivot Electrified (5/8" (16) Pin)	470	(SO)	470	(SO) 470
					108/109	503/599	600/601	700/701
	8062COV	227.004	Ea.	Top Walking Beam Pivot Cover Plate	17	(1)	17	(1) 17
						17	(SO)	17
						17	(SO)	17
								17

(1) Non-Fabricated item, ships in 1 business day
 (S) Non-Fabricated item, ships in 5 business days
 (SO) Special Fabricated/Finish or Special Order; lead time up to 5 weeks.

DRS Rails, Channels & Accessories
 Patch Fittings & Designer Pivots
 Offset Hung Patch Fittings
 Headers & Accessories
 Closers & Hardware
 Locksets
 Pulls & Handles
 Sliding Systems
 MANET
 Panic Hardware

Closer and Pivot Hardware

Pivots

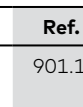
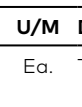
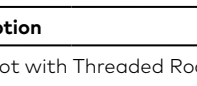
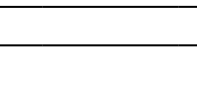
	Model	Ref. #	U/M	Description								List \$
	325.3 PT25	901.115	Ea.	Top Pivot with Threaded Rod								10 ^①
Finishes \$												
					101	108						
	325.6 PT24	901.116	Ea.	Top Pivot with 6 mm Mounting Plate	28 ^①	28 ^①						
							108/109			700		
	325.6 PT24	901.923	Ea.	3 mm Mounting Plate	28 ^①	31 ^①				37 ^①		
3/4" Top Offset Pivot					314 (Primer)	101	108/109	500/501	503/599	600/601/602		
		929.034	Ea.	3/4" Offset Top Pivot (75120) (Specify Hand)	121 ^{SO}	121 ^①	121 ^{SO}	121 ^①	121 ^{SO}	121 ^{SO}		
1-1/2" Top Offset Pivot												
		929.019	Ea.	1-1/2" Offset Top Pivot (15120) (Specify Hand)	195 ^{SO}	195 ^{SO}	195 ^{SO}	195 ^①	195 ^{SO}	195 ^{SO}		





① Non-Fabricated item, ships in 1 business day

SO Special Fabricated/Finish or Special Order; lead time up to 5 weeks.

NOTE: 75120 and 15120 in 700 or 701 Finish is Satin or Polished Chrome Bronze base metal.

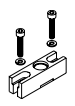
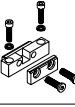
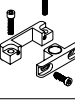
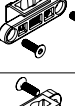
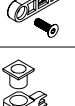
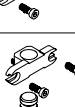
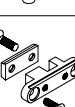
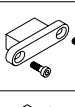
Closer and Pivot Hardware

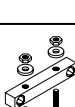
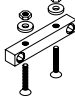
Inserts and Header Stops

	Model	Ref. #	U/M Description	List \$
Top Inserts				
	*355.0	904.610	Ea. Top Rail Insert for 15 mm Diameter Pin	29 ^①
	355.4	904.611	Ea. Top Rail Insert RTS	93 ^{SO}
	*355.9	904.091	Ea. Top Rail Adj. Insert	58 ^①
	319.1	903.105	Ea. Insert for PT 10 5/8" (15) – 3/4" (19) glass. Use with BTS, 7471K, or 355.5	21 ^①
		903.115	Ea. Insert for PT 10 3/8"(10) – 1/2" (12) glass. Use with BTS, 7471K, or 355.5	31 ^①
	*319.2	903.111	Ea. Top Fitting Insert for 15 mm Pin	17 ^①
	319.3	903.125	Ea. Top Fitting Pivot Insert	21 ^①
	355.41	903.999	Ea. Top Fitting Sideload Insert RTS88	27 ^①
	355.43	903.126	Ea. Top Fitting Insert Blank	17 ^①
	355.42	903.127	Ea. Top Fitting Insert Stop	21 ^①
Header Stops				
				Standard Finishes \$
				Custom Finishes \$
				101 108/109 500/501 503/599 600/601/602 199/299/399
	233.989	Ea. Header Stop	23 ^① 23 ^① 52 ^① 52 ^① 52 ^{SO} 69 ^{SO}	
Extension				
	**8521E	928.063	Ea. RTS88 Spindle Extension	42 ^③

- ① Non-Fabricated item, ships in 1 business day
- ③ Non-Fabricated item, ships in 3 business days
- SO Special Fabricated/Finish or Special Order; lead time up to 5 weeks.

* If using with walking beam top portion, use only with walking beam pivot PT21 (801.117). Other walking beam pins may not engage properly.

** dormakaba recommends never combining RTS88 size BFI, BFE, or SZ2 closer with 8521E add-on extended spindle. These closers may not generate enough power to close and latch a door if used in combination with 8521E.

DRS Rails, Channels & Accessories
 Patch Fittings & Designer Pivots
 Offset Hung Patch Fittings
 Headers & Accessories
 Closers & Hardware
 Locksets
 Pulls & Handles
 Sliding Systems
 MANET
 Panic Hardware

BTS Floor Closers

How to Determine Hand of Door

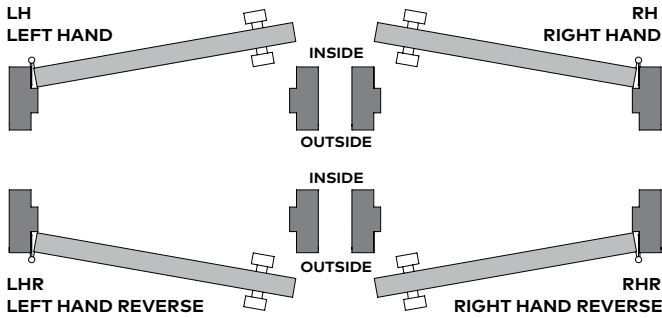

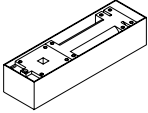
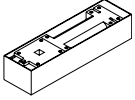
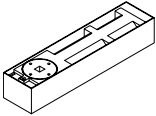
	Ref. #	U/M	Description	List \$
BTS75V Closers				①
	927.013	Ea.	HO 105°	653
	927.014	Ea.	HO 90°	653
	927.018	Ea.	NHO	631
BTS75V Closers – Barrier Free (BF)				
	927.016	Ea.	HO 90°	653
	927.017	Ea.	NHO	631
BTS80 Closers				
	927.020	Ea.	ANSI Size 4 (Standard)	676
	927.021	Ea.	ANSI Size 6 (Strong)	676
	927.019	Ea.	ANSI Size 3 (BFE)	676

- ① Non-Fabricated item, ships in 1 business day
- ② Non-Fabricated item, ships in 5 business days
- ③ Special Fabricated/Finish or Special Order; lead time up to 5 weeks.

NOTES:

- Cement box included with all BTS closers listed above. Additional cement boxes available.

BTS Floor Closers

Covers and Cement Boxes

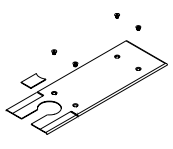
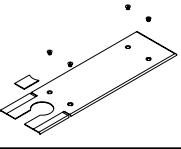
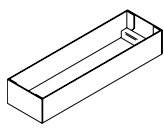
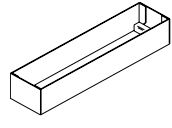
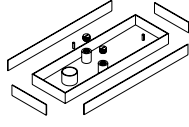
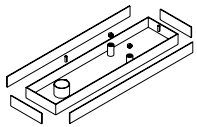
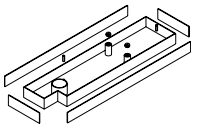
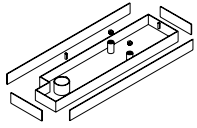
Model	Ref. #	U/M	Description	Finishes \$				
				503/599	600/602	*618/619	700/701	
Covers and Cement Boxes				(SO)	(SO)	(SO)	(1)	
	7510	927.043	Ea. BTS75V Cover	104	104	104	104	
	7410	227.003	Ea. BTS80 Cover	109	109	109	109	
							List \$	
	927.007	Ea.	BTS75V Cement Box					50 (3)
	927.008	Ea.	BTS80 Cement Box					51 (3)
	TP75V	927.049	Ea. BTS75V Terrazzo Cover CH					294 (3)
	TP80CH	927.046	Ea. BTS80 Terrazzo Cover CH					315 (3)
	TP80LH	927.047	Ea. BTS80 Terrazzo Cover LH 3/4" (19) Offset					343 (SO)
	TP80RH	927.048	Ea. BTS80 Terrazzo Cover RH 3/4" (19) Offset					343 (SO)

- (1) Non-Fabricated item, ships in 1 business day
- (3) Non-Fabricated item, ships in 3 business days
- (SO) Special Fabricated/Finish or Special Order; lead time up to 5 weeks.

* 618 and 619 satin and polished nickel respectively are BHMA finish codes.

DRS Rails, Channels & Accessories

Patch Fittings & Designer Pivots

Offset Hung Patch Fittings

Headers & Accessories

Closers & Hardware

Locksets



Pulls & Handles

Sliding Systems

MANET







Panic Hardware

BTS Spindles

	Model	Ref. #	U/M	Description	List \$
Bottom Spindles					
	74003	927.091	Ea.	5/16" (8) Spindle	51 ^①
	74005	927.092	Ea.	1/2" (13) Spindle	51 ^①
	74007	927.093	Ea.	5/8" (16) Spindle	51 ^①
	74010	927.094	Ea.	3/4" (19) Spindle	51 ^①
	74012	927.095	Ea.	13/16" (21) Spindle	64 ^⑤
	74015	927.096	Ea.	7/8" (22) Spindle	64 ^⑤
	74020	927.097	Ea.	1-1/8" (29) Spindle	64 ^⑤
	74025	927.098	Ea.	1-5/16" (33) Spindle	64 ^①
	74030	927.099	Ea.	1-1/2" (38) Spindle	64 ^①
	74035	927.100	Ea.	1-11/16" (43) Spindle	64 ^⑤
	74040	927.101	Ea.	1-7/8" (48) Spindle	64 ^{⑤⑩}
	74045	927.102	Ea.	2-1/16" (52) Spindle	64 ^{⑤⑩}
	74050	927.103	Ea.	2-5/16" (59) Spindle	64 ^{⑤⑩}

① Non-Fabricated item, ships in 1 business day
 ⑤ Non-Fabricated item, ships in 5 business days
 ⑩ Special Fabricated/Finish or Special Order; lead time up to 5 weeks.





BTS Spindles

Model	Ref. #	U/M	Description	List \$
Bottom 3° Offset Spindles				
	80003	927.104	Ea. 5/16" (8) Spindle Left Hand	51 ^①
		927.105	Ea. 5/16" (8) Spindle Right Hand	51 ^①
	80005	927.106	Ea. 1/2" (13) Spindle Left Hand	51 ^①
		927.107	Ea. 1/2" (13) Spindle Right Hand	51 ^①
	80010	927.108	Ea. 3/4" (19) Spindle Left Hand	51 ^①
		927.109	Ea. 3/4" (19) Spindle Right Hand	51 ^①
	80015	927.110	Ea. 7/8" (22) Spindle Left Hand	64 [Ⓢ]
		927.111	Ea. 7/8" (22) Spindle Right Hand	64 [Ⓢ]
	80020	927.112	Ea. 1-1/8" (29) Spindle Left Hand	64 [Ⓢ]
		927.113	Ea. 1-1/8" (29) Spindle Right Hand	64 [Ⓢ]
	80025	927.114	Ea. 1-5/16" (33) Spindle Left Hand	64 [Ⓢ]
		927.115	Ea. 1-5/16" (33) Spindle Right Hand	64 [Ⓢ]
	80030	927.116	Ea. 1-1/2" (38) Spindle Left Hand	64 [Ⓢ]
		927.117	Ea. 1-1/2" (38) Spindle Right Hand	64 [Ⓢ]

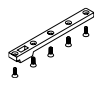
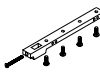
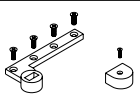

① Non-Fabricated item, ships in 1 business day
 Ⓢ Special Fabricated/Finish or Special Order; lead time up to 5 weeks.

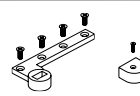
- DRS Rails, Channels & Accessories
- Patch Fittings & Designer Pivots
- Offset Hung Patch Fittings
- Headers & Accessories
- Closers & Hardware
- Locksets
- Pulls & Handles
- Sliding Systems
- MANET
- Panic Hardware

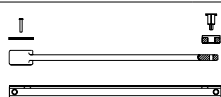
BTS Hardware

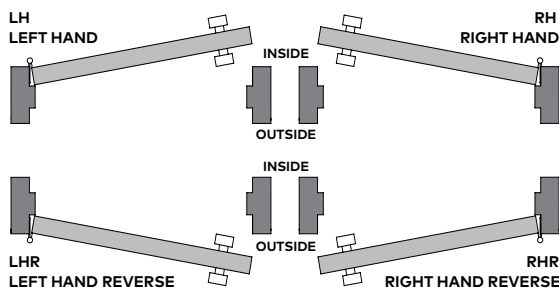
					Finishes \$				
Model	Ref. #	U/M	Description	101	108/109	503/599	600/601	500/501	
Bottom Arms				①	①	SO	SO	①	
 7421	227.001	Ea.	Bottom Arm	48	—	—	—	—	
 7422	227.002	Ea.	Bottom Arm	61	—	—	—	—	
Bottom 3/4" Offset Arm				107					
 75323	229.001	Ea.	Complete Right Hand	82	82	82	82	82	
	229.002	Ea.	Left Hand	82	82	82	82	82	
 75323 COV	929.006	Ea.	Offset Arm Cover Right Hand	24	24	24	24	24	
	929.007	Ea.	Left Hand	24	24	24	24	24	
Bottom 1-1/2" Offset Arm									
 15323	229.011	Ea.	Complete Right Hand	199	199	199	199	199	
	229.012	Ea.	Left Hand	199	199	199	199	199	
 15323 COV	929.037	Ea.	Offset Arm Cover Right Hand	30	30	30	30	30	
	929.038	Ea.	Left Hand	30	30	30	30	30	
 7451N/7453N	927.003	Ea.	Bottom Slide Arm	136 (100)					



Bottom/Floor Pivots				101/108 ^① 109 ^{SO}	503 ^① 599 ^{SO}	602 ^{SO}	700/701 ^①
 355.6	201.106	Ea.	Complete, Adjustable Floor Pivot 5/16" (8) to 1/2" (13) (includes cover, mounting hardware)	92	94	96	96
 901.079	901.079	Ea.	Adjustable Floor Pivot Cover Plate	20	23	24 ^{SO}	25

① Non-Fabricated item, ships in 1 business day

SO Special Fabricated/Finish or Special Order; lead time up to 5 weeks.

NOTE: 75323 & 15323 cover caps in 700 or 701 finish are Satin and Polished Chrome.

BTS Hardware

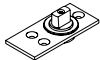
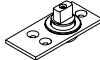
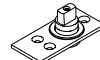
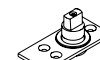
					101			
	355.5	904.602	Ea.	Floor Pivot 5/16" (8) Clearance	47 ^(SO)	—	—	—
	355.5 ext 5 mm	904.771	Ea.	Floor Pivot 1/2" (13) Clearance (5 mm ext.)	88 ^(SO)	—	—	—
	355.5 ext 10 mm	904.772	Ea.	Floor Pivot 11/16" (18) Clearance (10 mm ext.)	88 ^(SO)	—	—	—
	355.5 ext 15 mm	904.773	Ea.	Floor Pivot 15/16" (23) Clearance (15 mm ext.)	117 ^(SO)	—	—	—

① Non-Fabricated item, ships in 1 business day
 (SO) Special Fabricated/Finish or Special Order; lead time up to 5 weeks.

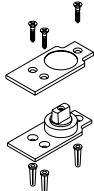
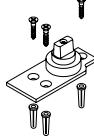
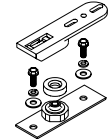
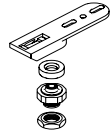
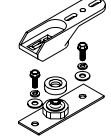
					Finishes \$				
Model	Ref. #	U/M	Description	101	108/109	503/599	600/601	700/701	
Floor Pivot with 3/4" Clearance				①	(SO)	(SO)	(SO)	①	
	7471K	229.003	Ea. Complete, Floor Pivot 3/4" (19) Clearance	74	74	74	74	74	
		929.008	Ea. Floor Pivot Cover	24	24	28	28	28 ①/(SO)	
Floor Pivots									
	7471K 5 mm ext.	229.051	Ea. Complete, Floor Pivot 15/16" (23) Clearance (5 mm ext.)	82	82	84	84	84	
List \$									
	8852	928.055	Ea. Bottom Pivot 7/8" (22) Web Depth (Adj. 3/8" (10)-5/8" (16))					46 ①	
	8855	928.058	Ea. Threshold Pivot 7/8" (22) Web Depth (Adj. 3/16" (5)-7/16" (11))					55 ①	
	8853	928.056	Ea. Bottom Pivot 1-9/16" (40) Web Depth (Adj. 1/4" (6)-1/2" (13))					56 ①	

① Non-Fabricated item, ships in 1 business day
 ⑤ Non-Fabricated item, ships in 5 business days
 (SO) Special Fabricated/Finish or Special Order; lead time up to 5 weeks.

DRS Rails, Channels & Accessories

Patch Fittings & Designer Pivots

Offset Hung Patch Fittings

Headers & Accessories

Closers & Hardware

Locksets

Pulls & Handles

Sliding Systems

MANET



Panic Hardware

Hardware

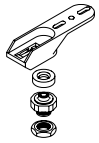
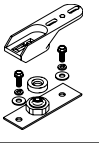
Floor Pivots

	8856	928.059	Ea. Threshold Pivot 1-3/8" (35) Web Depth (Adj. 3/16" (5)-7/16" (11))	55 ③
	8857	928.060	Ea. Bottom Pivot 1-9/16" (40) Web Depth (Adj. 3/16" (5)-7/16" (11))	55 ③

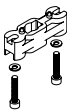
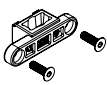
Bottom Inserts

	355.1	904.020	Ea. Rail Bottom Insert	37 ①
	319.1	903.105	Ea. Insert for PT10. For 3/8" (10) and 1/2" (12) glass. Use with BTS, 7471K, or 355.5	21 ①
		903.115	Ea. Insert for PT10 for 5/8" (16) and 3/4" (19) glass. Use with BTS, 7471K, or 355.5	31 ①

Shear Locks

	Ref. #	U/M Description	Finishes \$
EMSL Shear Locks			700
	933.025	Ea. EMSL 2765 Shear Lock not installed	1,277 ③

EML Magnetic Locks

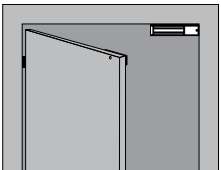
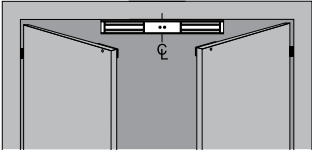
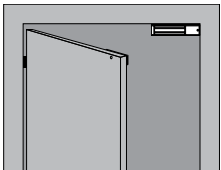
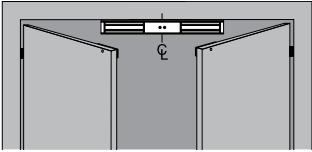
	08114722	Ea. EML 310 electromagnetic lock, single door, 1,500 lb (680 kg)	469
	08114742	Ea. EML 310 BA DP electromagnetic lock, single door, 1,500 lb (680 kg) with BA bond sensor and DP door position sensor	623
	08114842	Ea. EML 320 electromagnetic lock, double door, 1,500 lb (680 kg)	897
	08114862	Ea. EML 320 BA DP electromagnetic lock, double door, 1,500 lb (680 kg) with BA bond sensor and DP door position sensor	1,180
	925.811	Ea. EML 371 electromagnetic lock, single door, 750 lb (340 kg)	360
	925.812	Ea. EML 371 BA DP electromagnetic lock, single door, 750 lb (340 kg) with BA bond sensor and DP door position sensor	487
	925.810	Ea. EML 372 electromagnetic lock, double door, 750 lb (340 kg)	721
	925.813	Ea. EML 372 BA DP electromagnetic lock, double door, 750 lb (340 kg) with BA bond sensor and DP door position sensor	973











NOTE: Prices shown for EMSL or EML locks do not include factory fabrication or installation fees.

③ Non-Fabricated item, ships in 3 business days

Hardware

EML Magnetic Locks				Finishes \$
Model	Ref. #	Glass Thickness	Description	700
GDB14	925.882	1/2" (13)	Glass door bracket for EML-310 mag lock, single	163
GDB16	925.883	3/4" (19)	Glass door bracket for EML-310 mag lock, single	163
GDB24	925.884	1/2" (13)	Glass door bracket for EML-320 mag lock, double	326
GDB26	925.885	3/4" (19)	Glass door bracket for EML-320 mag lock, double	326
GDB714	925.886	1/2" (13)	Glass door bracket for EML-371 mag lock, single	163
GDB716	925.887	3/4" (19)	Glass door bracket for EML-371 mag lock, single	163
GDB724	925.888	1/2" (13)	Glass door bracket for EML-372 mag lock, double	326
GDB726	925.889	3/4" (19)	Glass door bracket for EML-372 mag lock, double	326

Locks and Cylinders

Locks				List \$
	925.019	Ea.	Brass Lock 1-9/16" (40) 5/8" (16) Throw (DRS Rail)	39 ^①
	925.119	Ea.	Brass Door Lock 1-9/16" (7/8" long throw fully retracted projects 1/4" below lock base)	54 ^⑤
	925.018	Ea.	Brass Lock 1-15/16" 5/8" Throw. Not for use with DRS Rails. Requires 1-15/16" lock height clearance in rail.	41 ^⑤
	925.021	Ea.	Extended Lock Bolt 1-7/8" (48) (5/8" (16) Throw, projects 1/4" (6) below lock base when fully retracted) (DRS Rail)	16 ^⑤
	925.022	Ea.	Square Lock Bolt	6 ^⑥
Cylinders				
				101/108 ^①
				500/501 ^⑥
	225.999	Ea.	Mortise Key Cylinder/ Split Ring (DRS)	21
	225.998	Ea.	Mortise Thumbturn Cylinder/ Split Ring (DRS)	21
	225.994	Ea.	Mortise Dummy (Blank) Cylinder for (DRS) Lock, with split ring	15
				101
	225.997	Ea.	Mortise Key Cylinder/ Blocking Ring (AR20)	21
	225.996	Ea.	Mortise Thumbturn Cylinder/ Blocking Ring (AR20)	21

① Non-Fabricated item, ships in 1 business day

⑤ Non-Fabricated item, ships in 5 business days





⑥ Special Fabricated/Finish or Special Order; lead time up to 5 weeks.

NOTES

- For Cylinder and Keying Options such as KA, see **Cylinder Types, Keying Options, and Keyways**.
- LH housing requires RH profile thumbturn cylinder; RH housing requires LH profile thumbturn cylinder.

* When retracted, long throw extends beyond lock base by 1/4" (6).



Hardware

Cylinders			108 ^①	500/501 ^{SO}
	225.995	Ea. Mortise Dummy (Blank) Cylinder for AR20 Lock, with blocking ring	15	15
	932.070	Ea. Mortise Cylinder Rose	17 (108 only)	17
			503/599	700 ^①
	901.003	Ea. Profile Key Cylinder	91	67
	901.002	Ea. Profile Thumbturn Cyl. RH Lock Housing	88	74
	901.004	Ea. LH Lock Housing	88	74

NOTES

- For Cylinder and Keying Options such as KA, see **Cylinder Types, Keying Options, and Keyways**.
- LH housing requires RH profile thumbturn cylinder; RH housing requires LH profile thumbturn cylinder.

Strikes, Saddles, Threshold

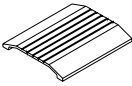
			Finishes \$				
	Ref #	U/M Description	101	109	500/501	503/599	600/601
Strikes							
	932.033	Ea. Dust Proof Strike Overall Length 1-1/2" (38)	30 ^①	30 ^①	30 ^①	30 ^{SO}	30 ^{SO}
				108/109	500		701
	925.140	Ea. Strike Plate	15 ^③	15 ^③	15 ^③	15 ^③	15 ^③
	932.908	Ea. Adjustable Strike	30 ^{SO}				
Saddles and Thresholds			100				
	925.058	Ft. 1/2" (13) x 4" (102) Threshold Available @ 16' Length	15 ^{SO}				

List \$

MITER	Miter cut charge per miter	65
-------	----------------------------	----

- ① Non-Fabricated item, ships in 1 business day
- ③ Non-Fabricated item, ships in 3 business days
- SO Special Fabricated/Finish or Special Order; lead time up to 5 weeks.

NOTES:

- Must specify length when ordering. dormkaba will cut to specified size, priced per foot only.
- Maximum length for extrusions is 144" (3.66 m) before requiring a splice joint; 120" (3 m) for Brass and Bronze finishes.

Locksets for Glass Doors

CLM9000	Ordering Guide	110
	Housing and Strikes Options	111
	Cast or Forged Levers	113
	Cylinder Types, Keying Options, and Keyways	115
Studio and Junior	Studio Lockset Housings and Strikes	116
	Junior Office Lockset Housings and Strikes	117
	Junior Office Classic Lockset	118
	Studio and Junior Levers, Knobs, and Accessories	119
ARCOS	ARCOS Lockset Housings and Strikes	120
	ARCOS Accessories	121
Locks for Sliding Doors	Locksets, Strikes, and Handles	122

DRS Rails,
Channels &
AccessoriesPatch Fittings
& Designer
PivotsOffset
Hung Patch
FittingsHeaders &
AccessoriesClosers &
Hardware

Locksets

Pulls &
HandlesSliding
Systems

MANET

Panic
Hardware

CLM9000

Ordering Guide

Trim

L118A	— Premium Designer Lever and A Rose
L117A	— Premium Designer Lever and A Rose
L114A	— Premium Designer Lever and A Rose
L112A	— Premium Designer Lever and A Rose
L110A	— Premium Designer Lever and A Rose
L109A	— Premium Designer Lever and A Rose
LVA	— Premium Curved Lever and A Rose
LNA	— Tapered Lever and A Rose
LFA	— Premium Curved Lever and A Rose
LDA	— Swept Lever and A Rose
LAA	— Premium Tubular No Return Lever and A Rose
LGA	— Curved No Return Lever
LTA	— Tubular Lever and A Rose and A Rose
LCA	— Curved Lever and A Rose
LRA	— Rectangular Lever and A Rose — (Default)

Lock Function

Classroom Intruder w/DB	9974
Storeroom	9080
Classroom	9070
Office/Entry (Alt F04) — (Default)	9053
Office/Entry	9050
Passage/Closet	9010

Less Levers

Less Both Levers/Roses	LLL
Less Both Levers	LB
Less Inside Lever/Rose	LILR
Less Outside Lever/Rose	LOLR

Glass Thickness

3/8"	— 3/8 (10)
1/2"	— 1/2" (12) — (Default)

Strike

LS	— Less Strike
STRKHSNG	— Strike Housing (Default)
WALLSTRK	— Wall Strike

CLM9	9053	C6	Y	LRA	700	LHR	1/2	STRKHSNG	XXXX
-------------	-------------	-----------	----------	------------	------------	------------	------------	-----------------	-------------

Model	CLM9	Conventional	D	N	Satin Stainless	700	RH	— Right Hand
		Combinated SFIC	C	Y — Default	Finish		RHR	— Right Hand Reverse
		Combination SFIC (6-Pin) (Default)	C6	Lever Handles			LH	— Left Hand
		SFIC w/Disposable Core	J				LHR	— Left Hand Reverse (Default)
		SFIC w/Temporary Construction Core	T					
		Less Conventional Core	L					
		Schlage LFIC (Less Core)	R					

Cylinder Type

Handing

Keying Options

See Page 113 for Keying Cylinder Options

CLM9000 Lockset Housing and Strikes

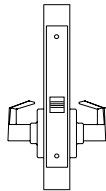
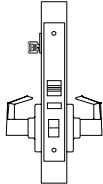
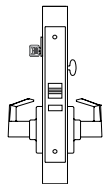
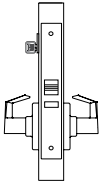
Model	Ref. #	U/M	Handing	Description	Finish \$
CLM9010 700				Passage/Closet – Latch bolt operated by trim either side	700 (SO)
	211.948	Ea.	RH		889
	211.949	Ea.	LH		889
	211.950	Ea.	RHR		889
	211.951	Ea.	LHR		889
CLM9050 C MKD (KD) 700				Office/Entry – Latch bolt operated by trim either side except when outside trim locked by stopworks. When outside trim locked, latch bolt retracted by key outside or operated by trim inside.	
	211.944	Ea.	RH		1,049
	211.945	Ea.	LH		1,049
	211.946	Ea.	RHR		1,049
	211.947	Ea.	LHR		1,049
CLM9053 C MKD (KD) 700				Office/Entry – Latch bolt operated by trim either side except when outside trim locked by key outside or by inside turn. If outside trim locked, latch bolt actuated by key outside or trim inside. Outside trim remains locked until inside turn set to unlock position or unlocked by key. Auxiliary latch deadlocks latch bolt when door locked.	
	211.940	Ea.	RH		1,177
	211.941	Ea.	LH		1,177
	211.942	Ea.	RHR		1,177
	211.943	Ea.	LHR		1,177
CLM9070 C MKD (KD) 700				Classroom – Latch bolt operates trim either side, except when outside trim locked by key outside. When outside trim locked, latch bolt operated by trim inside. Auxiliary latch deadlocks latch bolt.	
	211.962	Ea.	RH		1,049
	211.963	Ea.	LH		1,049
	211.964	Ea.	RHR		1,049
	211.965	Ea.	LHR		1,049

(SO) Special Order; lead time up to 5 weeks.

NOTE:

- Handing Based on American Standards (Opposite Euro DIN Standards)
- CLM9000 series does not come standard with a strike due to possible sidelite configurations. Customer must choose appropriate strike from the strike options on page 111 as an "add" option.

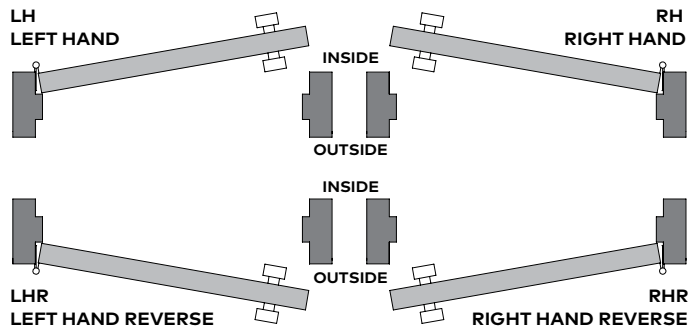

DRS Rails, Channels & Accessories
Patch Fittings & Designer Pivots
Offset Hung Patch Fittings
Headers & Accessories
Closers & Hardware
Locksets
Pulls & Handles
Sliding Systems
MANET
Panic Hardware

CLM9000 Lockset Housing and Strikes

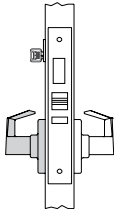
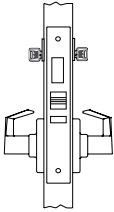
Model	Ref. #	U/M	Description	Finish \$
	Configured Only (CF)*		Storeroom — Latch bolt retracted by key outside or trim inside. Outside trim always rigid. Auxiliary Latch deadlocks latch bolt.	(SO) 700
	CLM9080 RH	Ea.		1,049
	CLM9080 LH	Ea.		1,049
	CLM9080 RHR	Ea.		1,049
	CLM9080 LHR	Ea.		1,049
			Classroom/Intruder w/ Dead Bolt — Latch bolt operates trim either side, except when locked by projection of dead bolt. Dead bolt actuated by key either side. Inside trim operates both bolts, outside trim remains locked. Key either side unlocks outside trim allowing latch bolt actuation. Auxiliary latch deadlocks latch bolt.	
	CLM9974 RH	Ea.		1,120
	CLM9974 LH	Ea.		1,120
	CLM9974 RHR	Ea.		1,120
	CLM9974 LHR	Ea.		1,120

(SO) Special Order; lead time up to 5 weeks.

NOTES:







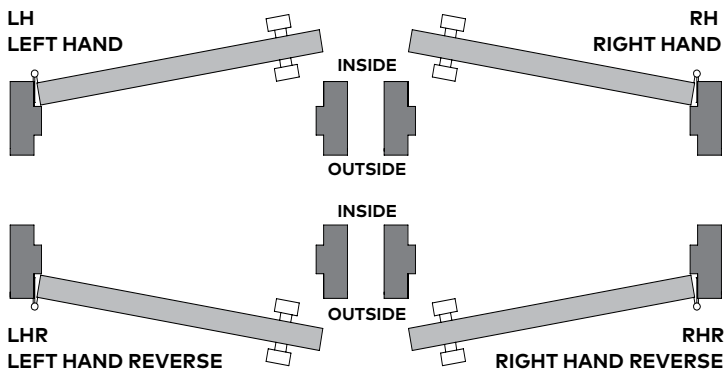

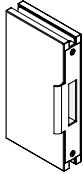

- Reference handing diagram and hand according to the locked side of the opening.
- Lever handles must be specified. Levers marked as N/C are included in the base price of the lockset. Other levers are an upcharge, listed accordingly, see page 113.
- SFIC Cylinder **C BA** Core is part of base price; (KD) only comes with 1 control and 2 change keys.
- For Cylinder and Keying Options such as KA, see **Cylinder Types, Keying Options, and Keyways**, page 115.
- Specify, 1/2" (12) or 3/8" (10) glass thickness.
- CLM9000 series does not come standard with a strike due to possible sidelite configurations. Customer must choose appropriate strike from the strike options on page 111 as an "add" option.

* CF product is configured to order only. No finished goods part numbers exist.

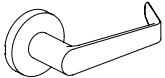
How to Determine Hand of Door

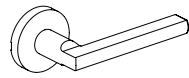

CLM9000 Lockset Strikes and Cast or Forged Levers

Model	Ref. #	UM	Description	Finish \$
CLM9000 Strikes (Strikes ordered independently of lock)				700
	211.921	Ea	Sidelite Mount Strike, Non-Handed (Cannot be used with 9974 deadbolt function)	683
	911.922	Ea	Strike for jamb/wall installation, No sidelite, Non-Handed	163
	911.923	Ea..	Handed Strike for CLM9974 jamb/wall installation (RH)	163
	911.924	Ea..	Handed Strike for CLM9974 jamb/wall installation (LH)	163
Standard Cast or Forged Levers			Trim	
	211.953	Set	LRA	N/C
	211.954	Set	LCA	N/C
	211.955	Set	LTA	N/C
	211.956	Set	LGA	Supplied only in a complimentary 500 finish (BHMA 626) N/C
	L118A	Set	L118A	N/C
	LFA	Set	LFA	Supplied only in a complimentary 500 finish (BHMA 626) N/C
	LVA	Set	LVA	Supplied only in a complimentary 500 finish (BHMA 626) N/C

⑤ Custom Fabricated; lead time up to 5 business days.

DRS Rails, Channels & Accessories

Patch Fittings & Designer Pivots

Offset Hung Patch Fittings

Headers & Accessories

Closers & Hardware

Locksets





Pulls & Handles

Sliding Systems

MANET

Panic Hardware

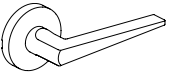
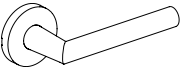
CLM9000 Cast or Forged Levers

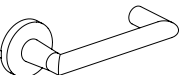
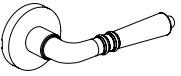
Model	Ref. #	U/M	Description	Finish Add \$
Premium Cast or Forged Levers				700
	211.952	Set	LAA	37
	211.957	Set	LDA	37
			Supplied only in a complimentary 500 finish (BHMA 626)	
	211.958	Set	LNA	37
			Supplied only in a complimentary 500 finish (BHMA 626)	
	211.959	Set	L110A	37
	211.961	Set	L114A	37
			Supplied only in a complimentary 500 finish (BHMA 626)	
	L109A	Set	L109A	37
	L112A	Set	L112A	37
	L117A	Set	L117A	37

 Special Order; lead time up to 5 weeks.

NOTES:

- All levers standard with "A" style Rose.
- "LL" = Less Lever/ Rose Set, deduct \$10.
- Lead time for premium levers will be determined by availability at the time order is placed. Premium levers are MTO (manufactured to order).

Cylinder Types, Keying Options, and Keyways

Cylinder	Option	Description		Add /Deduct \$
L		Lock less cylinder and cylinder ring	Example: CLM9070L	Deduct 75
Interchangeable Core Cylinders				
C		SFIC – Housing with combined SFIC construction core installed at the factory; BA (default), (KD), 1 control and 2 change keys BB, BC, BD, BE, BF, BG, BH, BJ, BK, BL, BM, BQ, D100 keyway (KA) – ☒ Keys sold separately	Example: CLM9070C	N/C
	MKD	Masterkeyed, Keyed Different (Keyed different to a random combination) or Keyed Alike; 1 control key and 2 change keys sold separately; Up to 20 days additional lead time for Keyed Alike. – Keys included unless cylinder purchased separately		N/C
J		SFIC – Housing with disposable plastic SFIC plug	Example: CLM9070J	Deduct 45
T		SFIC – Housing with keyed temporary SFIC construction core (Core may be returned for a full refund)	Example: CLM9070T	Deduct 5
R		Schlage LFIC – Housing less core	CLM9070R	Deduct 37
European Profile Cylinders				
Euro opt 1		Master keying for Euro Profile, single cylinder* (Up to 20 days additional lead time)		Deduct 31
Euro opt 2		Master keying for Euro Profile, double cylinder* (Up to 20 days additional lead time)		Deduct 14
Conventional Cylinders (non-interchangeable core)				
D		Conventional cylinder	Example: CLM9070D	Deduct 45
	KD	Keyed differently to a random combination; SC keyway with 2 keys (default)		Deduct 45
	KA2	Keyed alike in pairs to a random combination; SC keyway with 2 keys		Deduct 45
	NSK	Keyed alike (or Keyed to Order - KTO) sets of 3 or more; SC keyway with 2 keys		Deduct 33
	1-Bit SC	Operated by 1-bit key (sold separately); SC, SE keyway with 2 key blanks		Deduct 45
	0-Bit D-100	D100 keyway – ☒ Keys sold separately		Deduct 45
	0-Bit	Operated by a key blank; AA, CA, CB, CC, CD, CE, RA, RB, GA, SF, WA, YA, YG keyways with 2 keys		Deduct 35
	MKD	Master keyed; SC, SE, or D100 keyway – ☒ Keys sold separately		Deduct 29
	CMK	Construction master keyed single cylinder locks – ☒ Keys sold separately		Deduct 27

Cut Keys Ordered Separately

Part #	Description	List \$
45101	SFIC Cut Key – change key, master key, construction master key, or control key; BA, BB, BC, BD, BE, BF, BG, BH, BJ, BK, BL, BM, BQ, SC, SE keyways	6
45401	SFIC Cut Key – change key, master key, or control key; SKC keyways – D100 etc.	10
45404	CONV/LFIC Cut Key – 1-Bit key for operating 1-bit cylinders – SC, SE keyways	4





Locks will be supplied with SFIC C cylinder, Option BA MKD (KD).

☒ Denotes keys must be ordered separately.

NOTES:

- M9985D and M9986D are available MKD, CMK, or 0-bit only.
- Emergency keys for M9985D and M9986D are 45101 or 45401.
- D100 keyway is restricted. Call customer service for dormakaba SKC policies. Up to 20 days additional lead time

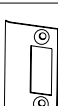

Studio Lockset Housings and Strikes

Model	Ref. #	U/M	Description	Finishes \$		
				101	107	108/109
Studio Rondo – Lockset Housings for Jambs or Sidelite Applications						
Non-Locking						
	910.200	Ea.	3/8" (10)	259 ⁵	346 ⁵	346 ^{8W}
	210.200	Ea.	1/2" (12)	259 ⁵	346 ⁵	346 ^{8W}
Non-Locking, Lever at Latch End						
	910.201	Ea.	3/8" (10)	259 ^{8W}	346 ^{8W}	346 ^{8W}
	210.003	Ea.	1/2" (12)	259 ^{8W}	346 ^{8W}	346 ^{8W}
Locking (Prepared for Europrofile Cylinder)						
	910.202	Ea.	3/8" (10)	259 ⁵	346 ⁵	346 ^{8W}
	210.001	Ea.	1/2" (12)	259 ⁵	346 ⁵	346 ^{8W}
Locking, Privacy Function, Thumb Turn Included						
	910.206	Ea.	3/8" (10)	378 ^{8W}	512 ^{8W}	443 ^{8W}
	210.206	Ea.	1/2" (12)	378 ^{8W}	512 ^{8W}	443 ^{8W}
Strike Housing (Sidelite Mount)						
	910.220	Ea.	3/8" (10)	280 ^{8W}	375 ^{8W}	401 ^{8W}
	210.004	Ea.	1/2" (12)	280 ^{8W}	375 ^{8W}	401 ^{8W}
Studio Classic – Lockset Housings for Jambs or Sidelite Applications						
Non-Locking						
	910.001	Ea.	3/8" (10)	259 ⁵	346 ⁵	443 ^{8W}
	210.012	Ea.	1/2" (12)	259 ⁵	346 ⁵	443 ^{8W}
Non-Locking, Lever at Latch End						
	910.002	Ea.	3/8" (10)	259 ⁵	346 ⁵	443 ^{8W}
	210.013	Ea.	1/2" (12)	259 ⁵	346 ⁵	443 ^{8W}
Locking (Prepared for Euro Cylinder)						
	910.003	Ea.	3/8" (10)	259 ⁵	346 ⁵	443 ^{8W}
	210.011	Ea.	1/2" (12)	259 ⁵	346 ⁵	443 ^{8W}
Locking, Privacy Function, Thumb Turn Cylinder Included						
	910.006	Ea.	3/8" (10)	378 ^{8W}	512 ^{8W}	583 ^{8W}
	210.006	Ea.	1/2" (12)	378 ^{8W}	512 ^{8W}	583 ^{8W}
Strike Housing (Sidelite Mount)						
	910.005	Ea.	3/8" (10)	280 ^{8W}	375 ⁵	478 ^{8W}
	210.014	Ea.	1/2" (12)	280 ^{8W}	375 ⁵	478 ^{8W}
Corner Strike Plate						
	910.401	Ea.	15/16" (24) Return	27 ^{8W}	40 ^{8W}	37 ^{8W}
	910.411	Ea.	5/8" (16) Return	27 ^{8W}	40 ^{8W}	—
Strike Plate						
	910.421	Ea.	Stainless Steel Base	—	18 ^{8W}	—

- ⁵ Custom Fabricated; lead time up to 5 business days.
- ^{8W} Special Order; custom product globally sourced from dormakaba factory.

- NOTES:**
- Levers are ordered separately for all locksets, See page 119.
 - Studio Locksets are shipped right hand reverse. Field adjustable to left hand levers
 - LHR Lockset Requires RH cylinder, RHR Lockset requires LH cylinder.

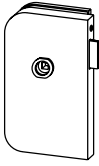
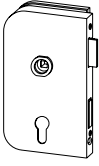
Junior Office Lockset Housings and Strikes

Model	Ref. #	U/M	Finishes \$			
			101	107	109	
Junior Office – Lockset Housings for Jamb or Sidelite Applications			8W	8W	8W	
	Non-Locking					
	811.264	Ea. 3/8" (10) LHR	227	310	313	
	811.265	Ea. 3/8" (10) RHR	227	310	313	
	211.264	Ea. 1/2" (12) LHR	227	310	313	
211.265	Ea. 1/2" (12) RHR	227	310	313		
	Locking, (Prepared for Europrofile Cylinder)					
	811.260	Ea. 3/8" (10) LHR	288	368	400	
	811.261	Ea. 3/8" (10) RHR	288	368	400	
	211.260	Ea. 1/2" (12) LHR	288	368	400	
211.261	Ea. 1/2" (12) RHR	288	368	400		
	Strike Housing (Sidelite Mount)					
	811.206	Ea. 3/8" (10) LHR	295	353	360	
	811.207	Ea. 3/8" (10) RHR	295	353	360	
	211.206	Ea. 1/2" (12) LHR	295	353	360	
211.207	Ea. 1/2" (12) RHR	295	353	360		
Junior Models				602	619	
	811.313	Ea. Strike Plate (Double)	58	—	—	—
	911.313	Ea. Strike Plate (Double)	—	—	—	62

8W Special Order; custom product globally sourced from dormakaba factory.

NOTES:

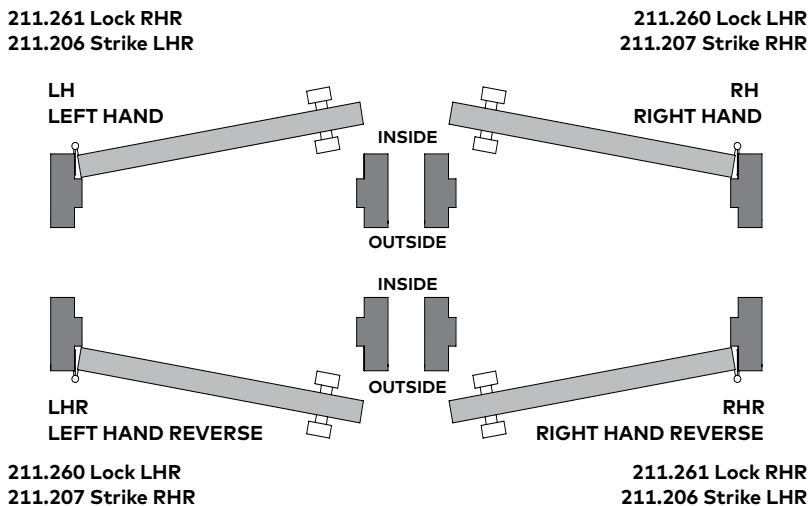

- Levers are ordered separately for all locksets. See page 119.
- LHR Lockset requires RH cylinder; RHR Lockset requires LH cylinder.

How to Determine Hand of Door

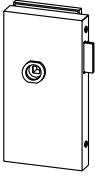
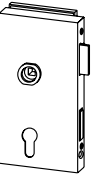
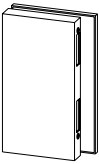

DRS Rails, Channels & Accessories
Patch Fittings & Designer Pivots
Offset Hung Patch Fittings
Headers & Accessories
Closers & Hardware
Locksets
Pulls & Handles
Sliding Systems
MANET
Panic Hardware

Junior Office Classic Lockset Housings and Strikes

Model	Ref. #	U/M	Description	Finishes \$		
				101	107	109
Junior Office Classic — Lockset Housings for Jamb or Sidelight Applications				8W	8W	8W
	Non-Locking					
	811.284	Ea.	3/8" (10) LHR	258	310	403
	811.285	Ea.	3/8" (10) RHR	258	310	403
	211.284	Ea.	1/2" (12) LHR	258	310	403
	211.285	Ea.	1/2" (12) RHR	258	310	403
	Locking (Prepared for Euro Cylinder)					
	811.280	Ea.	3/8" (10) LHR	288	360	515
	811.281	Ea.	3/8" (10) RHR	288	360	515
	211.280	Ea.	1/2" (12) LHR	288	360	515
	211.281	Ea.	1/2" (12) RHR	288	360	515
	Strike Housing (Sidelite Mount)					
	811.286	Ea.	3/8" (10) LHR	265	353	403
	811.287	Ea.	3/8" (10) RHR	265	353	403
	211.286	Ea.	1/2" (12) LHR	265	353	403
	211.287	Ea.	1/2" (12) RHR	265	353	403
Accessories				602	619	
	811.313	Ea.	Strike Plate (Double)	58	—	—
	911.313	Ea.	Strike Plate (Double)	—	—	62

8W Special Order; custom product globally sourced from dormakaba factory.



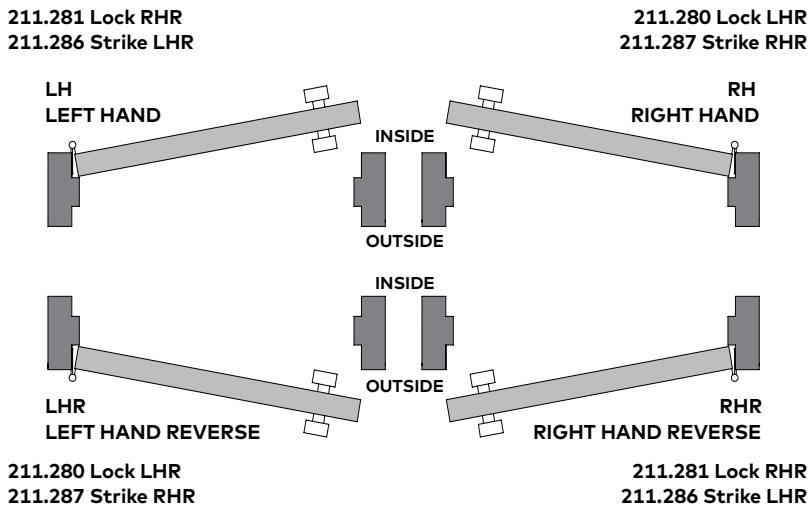

NOTES:

- Levers are ordered separately for all locksets. See page 119.
- LHR Lockset requires RH cylinder; RHR.
- Lockset requires LH cylinder.

How to Determine Hand of Door

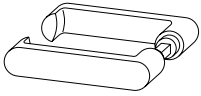

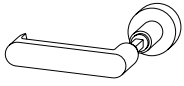
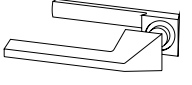
Studio and Junior Levers, Knob, and Accessories

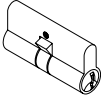
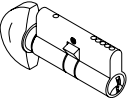
Model	Ref. #	U/M	Description	Finishes \$		
				101	107	199
Lever Sets						
	910.314	Ea.	Flat (471)	62 ⁵	80 ⁵	113 ^{8W}
	910.301	Ea.	Tubular (467.1)	137 ⁵	154 ⁵	198 ^{8W}
	910.304	Ea.	Flat Lever w/Knob One Side (450.20)	140 ^{8W}	205 ^{8W}	258 ^{8W}
	910.010	Ea.	Angular Lever	55 ^{8W}	85 ^{8W}	113 ^{8W}
	910.305	Ea.	Knob, Round (450.0)	126 ^{8W}	151 ^{8W}	—
Lever Sets						
	901.003	Ea.	Profile Key Cylinder (Euro Cylinder)		503/599	700
	901.002	Ea.	Profile Thumb Turn Cylinder, Right Hand Cam		91	67
	901.004	Ea.	Left Handed Cam Add, Profile Thumb Turn Cylinder.		88	74
				List ADD \$		
Master keying for Euro Profile (Double cylinder [CYLxCYL] = \$34 add). Up to 20 days additional lead time.				Per keyway	17	

- ⁵ Custom Fabricated; lead time up to 5 business days.
- ^{8W} Special Order; custom product globally sourced from dormakaba factory.





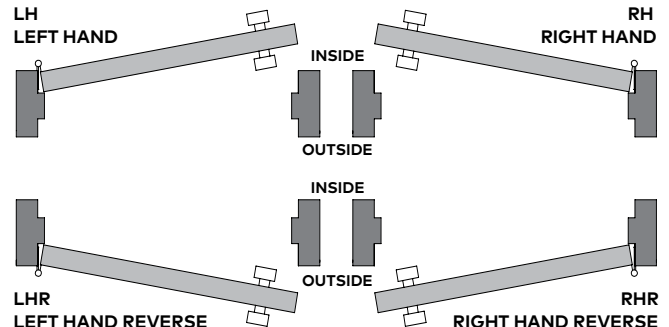





NOTES:

- Euro cylinders are KA by default and KD is a special order.
- LHR Lockset requires RH cylinder; RHR Lockset requires LH cylinder.
- For 108 or 109 finish requirements, specify 199 finish and specify "to be finished black or dark bronze." Check with factory for availability of 501 or 502 finish requirements.
- MKD (Master Keying) for Euro Profile cylinders, \$17 list add per keyway (Double cylinder [CYLxCYL] = \$34 add). Up to 20 days additional lead time.



DRS Rails, Channels & Accessories
Patch Fittings & Designer Pivots
Offset Hung Patch Fittings
Headers & Accessories
Closers & Hardware
Locksets
Pulls & Handles
Sliding Systems
MANET
Panic Hardware

ARCOS Lockset Housings and Strikes



Model	Ref. #	U/M Description	Finishes \$		
			107	108	114
ARCOS Studio – Lockset Housings for Jamb or Sidelite Applications					
Non-Locking					
	924.200	Ea. 3/8" (10)	346	447	288
	224.200	Ea. 1/2" (12)	346	447	288
Non-Locking, Lever at Latch End					
	924.201	Ea. 3/8" (10)	346	447	288
	224.201	Ea. 1/2" (12)	346	447	288
Locking, (Prepared for Euro Cylinder)					
	924.202	Ea. 3/8" (10)	346	447	288
	224.202	Ea. 1/2" (12)	346	447	288
Locking, Privacy Function, Thumb Turn Included					
	924.206	Ea. 3/8" (10)	511	580	429
	224.206	Ea. 1/2" (12)	511	580	429
Strike Housing (Sidelite Mount)					
	924.220	Ea. 3/8" (10)	302	388	254
	224.220	Ea. 1/2" (12)	302	388	254
ARCOS Office – Lockset Housings for Jamb or Sidelite Applications					
Non-Locking					
	825.264	Ea. 3/8" (10) LHR	327	431	242
	825.265	Ea. 3/8" (10) RHR	327	431	242
	225.264	Ea. 1/2" (12) LHR	327	431	242
	225.265	Ea. 1/2" (12) RHR	327	431	242
Locking (Prepared for Euro Cylinder)					
	825.260	Ea. 3/8" (10) LHR	386	547	305
	825.261	Ea. 3/8" (10) RHR	386	547	305
	225.260	Ea. 1/2" (12) LHR	386	547	305
	225.261	Ea. 1/2" (12) RHR	386	547	305
Strike Housing (Sidelite Mount)					
	825.206	Ea. 3/8" (10) LHR	370	449	285
	825.207	Ea. 3/8" (10) RHR	370	449	285
	225.206	Ea. 1/2" (12) LHR	370	449	285
	225.207	Ea. 1/2" (12) RHR	370	449	285

 Special Order; custom product globally sourced from dormakaba factory.

NOTES:

- Levers are ordered separately for all locksets. See ARCOS Accessories, page 121.
- ARCOS Studio Locksets are shipped right hand reverse. Field adjustable to left hand reverse.
- ARCOS Office Locksets left hand reverse shown.
- LHR Lockset requires RH cylinder; RHR Lockset requires LH cylinder.

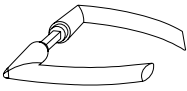
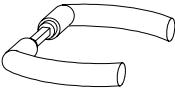
ARCOS Accessories

Model	Ref. #	U/M	Description	Finishes \$		
				107	114	199/399
Sets of Levers for Locks with Strikes				8W	8W	8W
	924.301	Ea.	Tubular, Mitered	186	176	261
				157	150	199/399
	824.310	Ea.	Tubular, Oval	186	176	261
	824.312	Ea.	Angular	207	195	280

NOTE: For 108 or 109 finish requirements, specify 199 finish and specify "to be finished black or dark bronze."

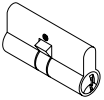
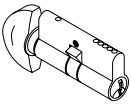
Model	Ref. #	U/M	Description	Finishes \$	
				503/599	700
Europrofile Accessories				8W	8W
	901.003	Ea.	Profile Key Cylinder (Euro Cylinder)	91	67
	901.002	Ea.	Profile Thumb Turn Cylinder, Right Hand Cam	88	74
	901.004	Ea.	Profile Thumb Turn Cylinder, Left Hand Cam	88	74
				List ADD \$	
Master keying for Euro Profile (Double cylinder [CYLxCYL] = \$34 add). Up to 20 days additional lead time.				Per keyway	17

8W Special Order; custom product globally sourced from dormakaba factory.

NOTES:

- Euro cylinders are KA by default and KD is a special order.
- LHR Lockset requires RH cylinders, RHR Lockset requires LH cylinder.
- MKD (Master Keying) for Euro Profile cylinders, \$17 list add per keyway (Double cylinder [CYLxCYL] = \$34 add). Up to 20 days additional lead time.

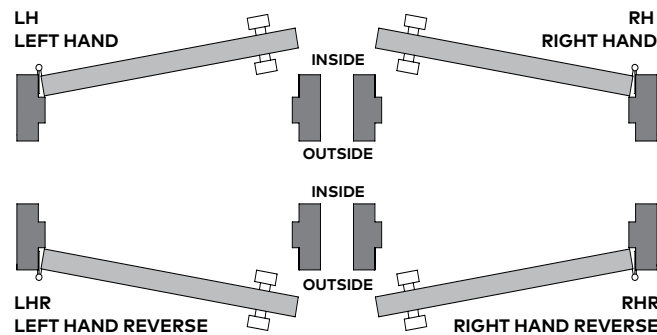

DRS Rails, Channels & Accessories

Patch Fittings & Designer Pivots

Offset Hung Patch Fittings

Headers & Accessories

Closers & Hardware

Locksets





Pulls & Handles

Sliding Systems

MANET

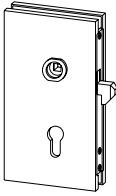
Panic Hardware

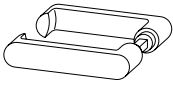
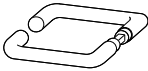
Locksets, Strikes, and Handles

			Finishes \$		
Model	Ref. #	U/M	101	105	108/109
Hook Lock			8W	8W	8W
	905.202	Ea. (Includes wall mounted strike plate)	396	515	661
Strike Box					
	905.201	Ea.	396	469	661
			199		
Set of Flat Lever Handles			5	8W	8W
	910.314	Set	62	80	113
Set of Tubular Lever Handles					
	910.301	Set	137	154	198
			113		
Flush Pull					
	907.200	Set	134 ①	201 ①	201 8W

- ⑤ Custom Fabricated; lead time up to 5 business days.
- ① Non-Fabricated item, ships in 1 business day.
- 8W Special Order; custom product globally sourced from dormakaba factory.

NOTES:

- Cylinders supplied keyed different (KD). For other cylinder and keying options such as keyed alike (KA) See **Cylinder Types, Keying Options, and Keyways**, page 115.
- For 108 or 109 finish requirements, specify 199 finish and specify "to be finished black or dark bronze."

Pulls and Handles for Tempered Glass Doors

TG 138 Ladder Pulls	Ordering Guide	124
	TG 138 Locking and Non-Locking Single and Back-to-Back Ladder Pulls	125
	TG 138 Accessories	126
	Cylinder Types, Keying Options, and Keyways	128
TG 9387 Ladder Pulls	Ordering Guide	129
	Stock Standard Size Non-Locking with Straight Fixing Posts	129
	Custom Size Non-Locking with Straight Fixing Posts	131
MANET Pulls	MANET Non-Locking with Straight Fixing Posts and MANET Clamping Disks	132
TG Decorative Pulls	TG 9000 Decorative Pulls and Handles	134
ARCOS and BEYOND Pulls	ARCOS and BEYOND Decorative Pulls and Handles	136
Economy Pulls	Economical Tubular and Solid Pulls and Handles	137
Finger Pulls and Knobs	Finger Pulls and Knobs for 3/8" (10) and 1/2" (12) Glass	138

DRS Rails,
Channels &
AccessoriesPatch Fittings
& Designer
PivotsOffset
Hung Patch
FittingsHeaders &
AccessoriesClosers &
Hardware

Locksets

Pulls &
HandlesSliding
Systems

MANET

Panic
Hardware

TG 138 Ladder Pulls

Ordering Guide

		Function		Door Thickness				Screwpack		<div style="border: 1px solid black; border-radius: 50%; padding: 10px; text-align: center;"> See Page 126 for Keying Cylinder Options </div>
		Locking — L		134 — 1-3/4" Wood Door				ROSE — Rose, up to 3-5/16"		
		Non-Locking — NL		75 — 5/8" or 3/4" Glass				SNUT — Sex Nut, up to 3-5/16"		
				STD — 3/8" or 1/2" Glass				BLIND — 1-3/4" wood door, not through door		
								B2B80 — Back-to-back up to 3-5/16" thick door		
								B2B44 — Back-to-back 1-3/4" wood		Keying Options
								B2B19 — Back-to-back 3/4" glass		
								B2B12 — Back-to-back 1/2" glass, STD. Pkg		
TG 138	NL	B2B	STD	49			B2B12	700	C6	XXXX
TG 138	Back-To-Back —	B2B	49" Length —	49	75ADAPT	Satin Stainless —	700	D	— Conventional	
Model	Single Sided —	SNG	60" Length —	60	Accessories	Custom Polished Finish —	701	L	— Less Conventional Cylinder	
			72" Length —	72		Custom Paint or Powder —	999	J	— Less SFIC	
		Pull Type	84" Length —	84			Finish	T	— Temporary SFIC Core	
			XX" (Specify) Length —	Custom				C	— 7-Pin SFIC Core	
					(L) Length			C6	— 6-Pin SFIC Core	
								R	— Schlage LFIC (Less Core)	
								THB	— Thumb Turn Single Pull Handle	
									Cylinder Type	

TG 138 Locking and Non-Locking Ladder Pulls

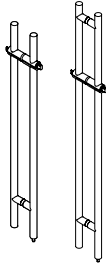
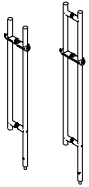
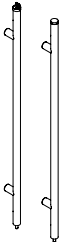
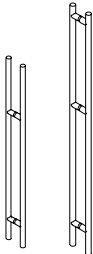
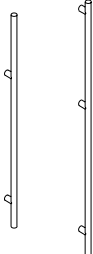
Locking Ladder Pull Configurations Single and Back-To-Back Locking and Non-Locking Pulls					Standard Finish \$	Custom Finish \$	
Model	Ref. #	U/M	No. Of Fixing Posts	Description	700	701	693
Back-to-Back Locking Ladder Pull with C Small Format Interchangeable Core (SFIC) Cylinder, BA Core MKD (KD)					3	SO	SO
	926.933	Set	3F	L B2B STD 84" (2134) 700	1,573	2,031	2,520
	926.932	Set	3F	L B2B STD 72" (1829) 700	1,533	1,978	2,386
	926.936	Set	3F	L B2B STD 60" (1524) 700	1,497	1,931	2,260
	926.930	Set	2F	L B2B STD 49" (1245) 700	1,437	1,853	2,080
Back-to-Back Locking Ladder Pull for ADA: 10" clear on exterior side with C Small Format Interchangeable Core (SFIC) Cylinder, BA Core MKD (KD)					3	SO	3
	926.945	Set	2F	L B2B STD 49"/39" interior (1245/991) (ADA)	2,161	2,603	2,489
	926.946	Set	3F	L B2B STD 60"/50" interior (1524/1270) (ADA)	2,305	2,777	2,668
Single Sided Locking Ladder Pull with C Cylinder (SFIC) , BA Core MKD (KD), or Thumb-Turn (TT)					999		
	926.934	Ea.	2F	L SNG STD 49" (1245) CYL 700	819	1,050	—
	926.935	Ea.	2F	L SNG STD 49" (1245) TT 700	819	1,050	—
NOTE: Cylinder or Thumb-Turn are Top Mounted							
Back-to-Back Non-Locking Ladder Pull							
	926.923	2 Ea.	3F	NL B2B STD 84" (2134) 700	667	866	880
	926.922	2 Ea.	3F	NL B2B STD 72" (1829) 700	629	817	843
	926.924	2 Ea.	3F	NL B2B STD 60" (1524) 700	590	766	804
	926.920	2 Ea.	2F	NL B2B STD 49" (1245) 700	530	689	744
NOTE: Non-locking ladder pulls are stocked in single units. Specify 2 Ea. during ordering for a back-to-back set. Includes appropriate fixings.							
Single Sided Non-Locking Ladder Pull							
	926.923	Ea.	3F	NL SNG STD 84" (2134) 700	386	502	515
	926.922	Ea.	3F	NL SNG STD 72" (1829) 700	365	474	493
	926.924	Ea.	3F	NL SNG STD 60" (1524) 700	342	445	471
	926.920	Ea.	2F	NL SNG STD 49" (1245) 700	307	399	435
NOTE: Customer must specify Fixing Pack and adjust List Price accordingly for Non-Locking Single Ladder Pulls.							

NOTES:

- Default cylinder for TG 138 L pulls uses SFIC **C** Cylinder **BA** Core.
- Other cylinder and keying options available, see **Cylinder Types, Keying Options, and Keyways**, page 128.
- 999 Finish is Custom Paint and Powder only.
- Default glass thickness is 3/8" (10) – 3/4" (19) for non-locking pulls. For locking pulls default glass thickness is 3/8" (10) – 5/8" (16). For locking pulls with *3/4" (19) thick glass order 926.911 from following page.

- SO Special Fabricated/Finish or Special Order; lead time up to 9 weeks.
- 5 Non-Fabricated item, ships in 5 business days.

DRS Rails, Channels & Accessories
Patch Fittings & Designer Pivots
Offset Hung Patch Fittings
Headers & Accessories
Closers & Hardware
Locksets
Pulls & Handles
Sliding Systems
MANET
Panic Hardware

TG 138 Locking and Non-Locking Ladder Pulls Accessories

Mounting	Ref. #	Description		List \$
	926.891	Adaptor, .75 adaptor allows NL Pull to install in Locking Post Prep		5
	926.937	Strike, Dustproof, Standard 1-1/8" (29)		40
Door Thickness				
	926.890	Locking Post Mounting Pack, Back-to-back, (Non-Locking Post— Fasteners not included)	1-3/4" (44)	216
	926.941	Mounting Pack, Back-to-back, Non-Locking	3/8" (10) – 3/4" (19)	47
	926.911	Locking Post Mounting Pack, Back-to-back, (Non-Locking Post— Fasteners not included)	3/4" (19)	227
	926.909	Mounting Pack, Back-to-back Non-Locking Post	1-3/8" (34) – 1-3/4" (44)	57

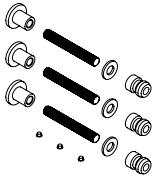
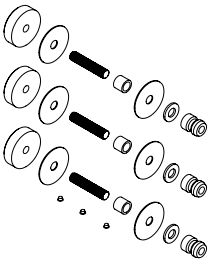
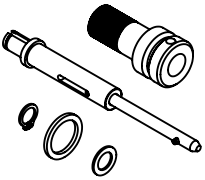
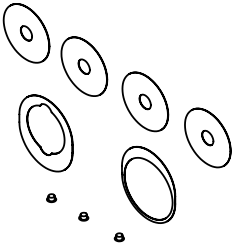
Mounting	Ref. #	Description	Door Thickness	List \$
	926.910	Mounting Pack, SNG Blind, 3 each in pack (Will not project through door)	min. 1-3/4" (44)	27
	926.908	Mounting Pack, Single Non-Locking x Sex Nut	3/4" (19) – 3-1/8" (80)	60
	926.906	Mounting Pack, Single Non-Locking x Rose	3/8" (10) – 3/4" (19)	58
	926.938	Locking Post Replacement Set for Standard 1/2" Glass Thickness	1/2" (13)	120
	926.939	Washer Pack		15

(SO) Special Fabricated/Finish or Special Order; lead time up to 9 weeks.

NOTE: Default cylinder for Locking Ladder pulls uses SFIC T cylinder with temporary construction core in 626 Satin.
Other cylinder and keying options available, see next page.

DRS Rails,
Channels &
Accessories

Patch Fittings
& Designer
Pivots

Offset
Hung Patch
Fittings

Headers &
Accessories

Closers &
Hardware

Locksets

Pulls &
Handles

Sliding
Systems

MANET

Panic
Hardware

Cylinder Types, Keying Options, and Keyways

Cylinder	Option	Description		Deduct \$
L		Lock less cylinder and cylinder ring	Example: TG138L	Deduct 80
Interchangeable Core Cylinders				
C		SFIC – Housing with combined SFIC construction core installed at the factory; BA (default), (KD), 1 control and 2 change keys BB, BC, BD, BE, BF, BG, BH, BJ, BK, BL, BM, BQ, D100 keyway (KA) – ☒ Keys sold separately	Example: TG138C	N/C
	MKD	Masterkeyed, Keyed Different (Keyed different to a random combination) or Keyed Alike; 1 control key and 2 change keys sold separately; Up to 20 days additional lead time for Keyed Alike. – Keys included unless cylinder purchased separately		N/C
J		SFIC – Housing with disposable plastic SFIC plug	Example: TG138J	Deduct 45
T		SFIC – Housing with keyed temporary SFIC construction core (Core may be returned for a full refund)	Example: TG138T	Deduct 5
R		Schlage LFIC – Housing less core	TG138R	Deduct 37
European Profile Cylinders				
Euro opt 1		Master keying for Euro Profile, single cylinder* (Up to 20 days additional lead time)		Deduct 31
Euro opt 2		Master keying for Euro Profile, double cylinder* (Up to 20 days additional lead time)		Deduct 14
Conventional Cylinders (non-interchangeable core)				
D		Conventional cylinder	Example: TG138D	Deduct 45
	KD	Keyed differently to a random combination; SC keyway with 2 keys (default)		Deduct 45
	KA2	Keyed alike in pairs to a random combination; SC keyway with 2 keys		Deduct 45
	NSK	Keyed alike (or Keyed to Order – KTO) sets of 3 or more; SC keyway with 2 keys		Deduct 33
	1-Bit SC	Operated by 1-bit key (sold separately); SC, SE keyway with 2 key blanks		Deduct 45
	0-Bit D-100	D100 keyway – ☒ Keys sold separately		Deduct 45
	0-Bit	Operated by a key blank; AA, CA, CB, CC, CD, CE, RA, RB, GA, SF, WA, YA, YG keyways with 2 keys		Deduct 33
	MKD	Master keyed; SC, SE, or D100 keyway – ☒ Keys sold separately		Deduct 29
	CMK	Construction master keyed single cylinder locks – ☒ Keys sold separately		Deduct 27
Cut Keys Ordered Separately				
Part #	Description			List \$
45101	SFIC Cut Key – change key, master key, construction master key, or control key; BA, BB, BC, BD, BE, BF BG, BH, BJ, BK, BL, BM, BQ, SC, SE keyways			6
45401	SFIC Cut Key – change key, master key, or control key; SKC keyways – D100 etc.			10
45404	CONV/LFIC Cut Key – 1-Bit key for operating 1-bit cylinders – SC, SE keyways			4

Locks will be supplied with SFIC C cylinder, Option BA MKD (KD).

☒ Denotes keys must be ordered separately.

NOTES:

- M9985D and M9986D are available MKD, CMK, or 0-bit only.
- Emergency keys for M9985D and M9986D are 45101 or 45401.
- D100 keyway is restricted. Call customer service for dormakaba SKC policies. Up to 20 days additional lead time

TG 9387 Ladder Pulls

Ordering Guide

		Door Thickness		SNG Mounting Type	
3/8" Thick Glass Screw Pack	—	3/8		ROSE	— Screw-on-Rose
1/2" Thick Glass Screw Pack	—	1/2		BLIND	— Concealed
5/8" Thick Glass Screw Pack	—	5/8			
3/4" Thick Glass Screw Pack	—	3/4			
1-3/8" Thick Wood Screw Pack	—	138			
1-3/4" Thick Wood Screw Pack	—	134			
>1-3/4" Thick Wood Screw Pack	—	other			

S-TG 9387	SNG	134	18	BLIND	700
------------------	------------	------------	-----------	--------------	------------

S-TG 9387	Single Sided — SNG	12" Length — 12	dormakaba 700/ BHMA 630 Finish	700
Model	Back-To-Back — B2B	18" Length — 18		
	Pull Type	36" Length — 36		
		42" Length — 42		
		60" Length — 60		
		(L) Length		Finish

Stock TG 9387 Standard Size Non-Locking Ladder Pulls, with Straight Fixing Posts

Stock Pull Handles for 1/2" Glass Doors						Finish \$
Model	Ref. #	U/M	No. Of Fixing Posts	Description		700
Back-to-Back 1-1/4" (32) Dia.						3
	B2B.905.370	Set	3F	L = 60" (1524) CTC = 37-1/2" (953)		262
	B2B.905.371	Set	2F	L = 42" (1067) CTC = 26-1/4" (667)		180
	B2B.905.372	Set	2F	L = 36" (914) CTC = 22-1/2" (572)		163
	B2B.905.373	Set	2F	L = 18" (457) CTC = 11-1/4" (286)		131
	B2B.905.382	Set	2F	L = 18" (457) CTC = 12" (305)		131
	B2B.905.374	Set	2F	L = 12" (305) CTC = 7-1/2" (191)		122
Single Sided 1-1/4" (32) Dia.						3
	SNG.905.370	Ea.	3F	L = 60" (1524) CTC = 37-1/2" (953)		134
	SNG.905.371	Ea.	2F	L = 42" (1067) CTC = 26-1/4" (667)		91
	SNG.905.372	Ea.	2F	L = 36" (914) CTC = 22-1/2" (572)		82
	SNG.905.373	Ea.	2F	L = 18" (457) CTC = 11-1/4" (286)		66
	SNG.905.382	Ea.	2F	L = 18" (457) CTC = 12" (305)		66
	SNG.905.374	Ea.	2F	L = 12" (305) CTC = 7-1/2" (191)		62
						Net Add \$
POWDER	All Custom powder coated orders will include a net charge per purchase order.					200

NOTES:

- Prefix Ref. # with (SNG) single or (B2B) back-to-back. Specify part number, pull height, door material, and door thickness. For single pull on wood door, specify roses or blind fasteners.
- Inserts and mounting hardware included in stock pull TG 9387, list price as shown.
- Mounting hardware also available as multi-pack service packs and priced separately following pulls.

DRS Rails, Channels & Accessories
Patch Fittings & Designer Pivots
Offset Hung Patch Fittings
Headers & Accessories
Closers & Hardware
Locksets
Pulls & Handles
Sliding Systems
MANET
Panic Hardware

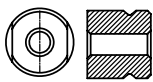
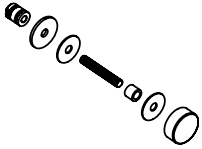
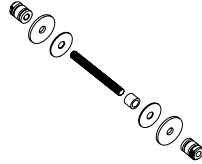
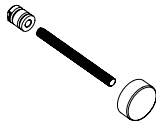
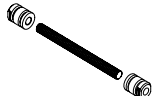
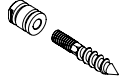
Model	Ref. #	U/M	Description	List \$
	905.390	Set	Service inserts, reduces post thread from 8 mm – 6 mm, used for every mounting post. Bulk pack of 6. Used as service item.	8
	905.387	Set	Service mounting pack with finished mounting ROSE used for SNG GLASS mount 3/8" – 3/4" (10 – 19). Bulk pack of 6. Used as service item.	45
	905.385	Set	Service mounting pack used for BACK-TO-BACK GLASS mount 3/8" – 3/4" (10 – 19). Bulk pack of 6. Used as service item.	45
	905.388	Set	Service mounting pack with finished mounting ROSE used for SNG WOOD mount 1-3/8" – 2" (40 – 51). Bulk pack of 6. Used as service item.	35
	905.386	Set	Service mounting pack used for BACK-TO-BACK WOOD mount 1-3/8" – 2" (40 – 51). Bulk pack of 6. Used as service item.	18
	905.389	Set	Service mounting pack with BLIND (concealed) fasteners, used for SNG WOOD mount ≥ 1-3/8" (40). Bulk pack of 6. Used as service item.	18

øG	1-1/4" (32)					
øS	1" (25)					
H	3-3/8" (85)					
3 fixings required	60" (1,524)					
(CTC) Center-to-Center	37-1/2" (953)	26-1/4" (667)	22-1/2" (571)	11-1/4" (286)	12" (305)	7-1/2" (191)
L (Length)	60" (1,524)	42" (1,067)	36" (914)	18" (457)	18" (457)	12" (305)

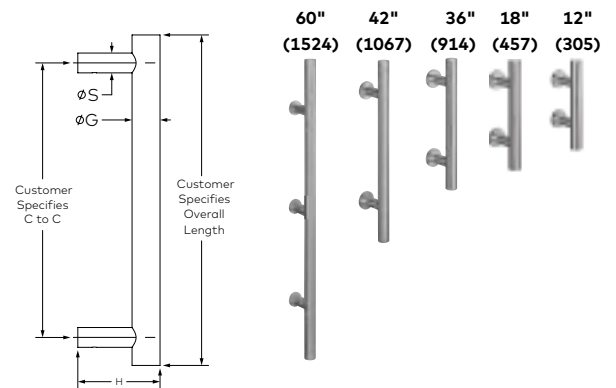

TG 9387 Custom Size Non-Locking Ladder Pulls, with Straight Fixing Posts

Pull Handles for 1/2" Glass Doors, Includes Fixings for 1/2" Glass & Roses					Standard Finish \$		Custom Finish \$
Model	Ref. #	U/M	No. Of Fixing Posts	Description	700	701	999
Back-to-Back 1-1/4" (32) Dia.					(SO)	(SO)	(SO)
	905.568	Ea.	3F	L = 94-1/2" through 110-3/16"	1,167	1,284	1,595
	905.567	Ea.	3F	L = 74-13/16" through 94-7/16"	1,010	1,111	1,438
	905.566	Ea.	2F	L = 59-1/16" through 74-3/4"	853	938	1,281
	905.565	Ea.	2F	L = 43-5/16" through 59"	696	765	1,017
	905.564	Ea.	2F	L = 27-9/16" through 43-1/4"	538	592	859
	905.563	Ea.	2F	L = 11-13/16" through 27-1/2"	380	418	701
Single Sided 1-1/4" (32) Dia.							
	905.368	Ea.	3F	L = 94-1/2" through 110-3/16"	690	760	904
	905.367	Ea.	3F	L = 74-13/16" through 94-7/16"	605	666	819
	905.366	Ea.	2F	L = 59-1/16" through 74-3/4"	519	571	733
	905.365	Ea.	2F	L = 43-5/16" through 59"	433	477	594
	905.364	Ea.	2F	L = 27-9/16" through 43-1/4"	348	383	508
	905.363	Ea.	2F	L = 11-13/16" through 27-1/2"	261	287	422
Back-to-Back 1" (25) Dia.							
	905.527	Ea.	3F	L = 94-1/2" through 110-3/16"	1,017	1,118	1,444
	905.526	Ea.	3F	L = 74-13/16" through 94-7/16"	904	995	1,332
	905.525	Ea.	3F	L = 59-1/16" through 74-3/4"	792	871	1,220
	905.524	Ea.	2F	L = 43-5/16" through 59"	679	748	1,000
	905.523	Ea.	2F	L = 27-9/16" through 43-1/4"	567	624	888
	905.522	Ea.	2F	L = 11-13/16" through 27-1/2"	455	501	776
Single Sided 1" (25) Dia.							
	905.327	Ea.	3F	L = 94-1/2" through 110-3/16"	659	726	873
	905.326	Ea.	3F	L = 74-13/16" through 94-7/16"	587	646	801
	905.325	Ea.	3F	L = 59-1/16" through 74-3/4"	516	567	730
	905.324	Ea.	2F	L = 43-5/16" through 59"	444	489	605
	905.323	Ea.	2F	L = 27-9/16" through 43-1/4"	372	410	533
	905.322	Ea.	2F	L = 11-13/16" through 27-1/2"	300	330	460

Net Add \$

POWDER All Custom powder coated orders will include a **net charge** per purchase order.

200

øG	1" (25)	1-1/4" (32)
øS	11/16" (18)	1" (25)
H	2-15/16" (75)	3-3/8" (85)
3 fixings required	59-1/16" (1,500)	59-1/16" (1,500)

(SO) Special Fabricated/Finish or Special Order; lead time up to 5 weeks.

NOTES:

- When required, 3rd fixing post is centered on L dimension unless otherwise requested. Any center distance specifically tailored to your requirements.
- Specify door thickness and desired screwpack.

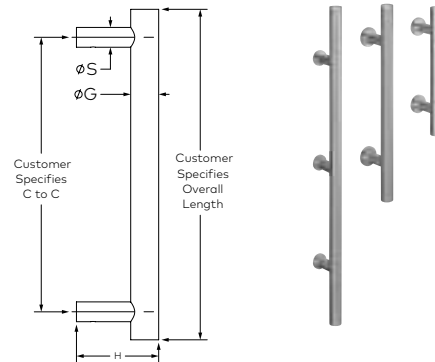

DRS Rails, Channels & Accessories
Patch Fittings & Designer Pivots
Offset Hung Patch Fittings
Headers & Accessories
Closers & Hardware
Locksets
Pulls & Handles
Sliding Systems
MANET
Panic Hardware

MANET Non-Locking Ladder Pulls, with Straight Fixing Posts and MANET Clamping Disks

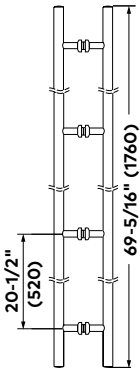
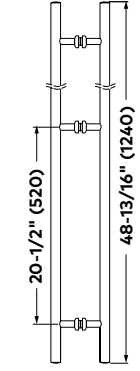
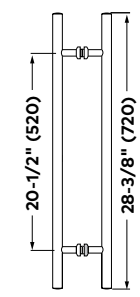
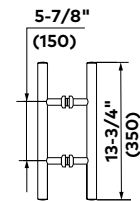
Pull Handles for 3/8" (9) or 1/2" (12) Glass Doors, Back-to-Back (B2B) or Single Sided					Standard Finish \$	Custom Finish \$
Model	Ref. #	U/M	No. Of Fixing Posts	Description	700	999
Back-To-Back					①	SO
	821.276	Ea.	4F	20-1/2" (520) Center-to-Center Length 69-5/16" (1760)	650	1,243
	821.273	Ea.	3F	20-1/2" (520) Center-to-Center Length 48-13/16" (1240)	540	1,143
	821.270	Ea.	2F	20-1/2" (520) Center-to-Center Length 28-3/8" (720)	432	770
	821.269	Ea.	2F	5-7/8" (150) Center-to-Center Length 13-3/4" (350)	315	636

Net Add \$

POWDER All Custom powder coated orders will include a **net charge** per purchase order.

200

- ① Non-Fabricated item, ships in 1 business day
- SO Special Fabricated/Finish or Special Order; lead time up to 5 weeks.

NOTES:

- Specify door thickness.
- Specify 829.991 for 1-3/4" (44) wood door fasteners, no additional charge.

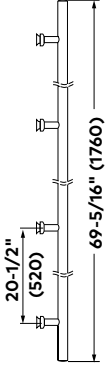
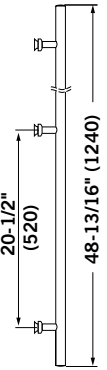
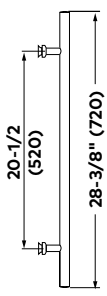
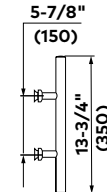
Pull Handles for 3/8" (9) or 1/2" (12) Glass Doors, Back-to-Back (B2B) or Single Sided					Standard Finish \$	Custom Finish \$
Model	Ref. #	U/M	No. Of Fixing Posts	Description	700	999
Single Sided					(S0)	(S0)
	821.243	Ea.	4F	20-1/2" (520) Center-to-Center Length 69-5/16" (1760)	507	721
	821.242	Ea.	3F	20-1/2" (520) Center-to-Center Length 48-13/16" (1240)	412	626
	821.241	Ea.	2F	20-1/2" (520) Center-to-Center Length 28-3/8" (720)	286	446
	821.240	Ea.	2F	5-7/8" (150) Center-to-Center Length 13-3/4" (350)	234	395
Net Add \$						
POWDER	All Custom powder coated orders will include a net charge per purchase order.					200

(S0) Special Fabricated/Finish or Special Order; lead time up to 5 weeks.

NOTES:

- Specify door thickness.
- Specify 829.991 for 1-3/4" (44) wood door fasteners, no additional charge.

DRS Rails, Channels & Accessories
Patch Fittings & Designer Pivots
Offset Hung Patch Fittings
Headers & Accessories
Closers & Hardware
Locksets
Pulls & Handles
Sliding Systems
MANET
Panic Hardware

TG 9335 Decorative Pulls, Straight Pull with Mitered Corners/Posts

Pull Handles for 1/2" Glass Doors, Includes Fixings for 1/2" Glass & Roses					Standard Finish \$		Custom Finish \$
Model	Ref. #	U/M	No. Of Fixing Posts	Description	700	701	999
Back-to-Back 1-1/4" (32) Dia.					(SO)	(SO)	(SO)
	905.545	Ea.	3F	CTC = 94-1/2" through 110-3/16"	1,072	1,179	1,500
	905.544	Ea.	3F	CTC = 74-13/16" through 94-7/16"	922	1,014	1,350
	905.543	Ea.	3F	CTC = 59-1/16" through 74-3/4"	773	850	1,201
	905.542	Ea.	2F	CTC = 43-5/16" through 59"	623	685	944
	905.541	Ea.	2F	CTC = 27-9/16" through 43-1/4"	473	520	794
	905.540	Ea.	2F	CTC = 7-7/8" through 27-1/2"	323	355	644
Single Sided 1-1/4" (32) Dia.							
	905.345	Ea.	3F	CTC = 94-1/2" through 110-3/16"	643	707	857
	905.344	Ea.	3F	CTC = 74-13/16" through 94-7/16"	561	616	775
	905.343	Ea.	3F	CTC = 59-1/16" through 74-3/4"	478	526	692
	905.342	Ea.	2F	CTC = 43-5/16" through 59"	396	435	556
	905.341	Ea.	2F	CTC = 27-9/16" through 43-1/4"	314	345	474
	905.340	Ea.	2F	CTC = 7-7/8" through 27-1/2"	233	257	394
Back-to-Back 1" (25) Dia.							
	905.506	Ea.	3F	CTC = 94-1/2" through 110-3/16"	1,354	1,489	1,782
	905.505	Ea.	3F	CTC = 74-13/16" through 94-7/16"	1,198	1,318	1,626
	905.504	Ea.	3F	CTC = 59-1/16" through 74-3/4"	1,043	1,148	1,471
	905.503	Ea.	2F	CTC = 43-5/16" through 59"	888	977	1,209
	905.502	Ea.	2F	CTC = 27-9/16" through 43-1/4"	733	807	1,054
	905.501	Ea.	2F	CTC = 8-1/4" through 27-1/2"	578	636	899
Single Sided 1" (25) Dia.							
	905.306	Ea.	3F	CTC = 94-1/2" through 110-3/16"	794	873	1,008
	905.305	Ea.	3F	CTC = 74-13/16" through 94-7/16"	707	778	921
	905.304	Ea.	3F	CTC = 59-1/16" through 74-3/4"	621	683	835
	905.303	Ea.	2F	CTC = 43-5/16" through 59"	534	587	694
	905.302	Ea.	2F	CTC = 27-9/16" through 43-1/4"	447	492	608
	905.301	Ea.	2F	CTC = 8-1/4" through 27-1/2"	361	397	521
							Net Add \$
POWDER	All Custom powder coated orders will include a net charge per purchase order.						200

(SO) Special Fabricated/Finish or Special Order; lead time up to 5 weeks.

NOTES:

- When required, 3rd fixing post is centered on CTC dimension unless otherwise requested.
- CTC = Center-to-center of mounting posts.
- Specify Door thickness and desired screwpack.

TG Decorative Pulls

Pull Handles for 1/2" Glass Doors, Includes Fixings for 1/2" Glass & Roses **Standard Finish \$** **Custom Finish \$**

Model	Ref. #	U/M	Description	700	701	999
-------	--------	-----	-------------	-----	-----	-----

TG 9830 Bowed Pull, 13-3/4" (349) Center-to-Center (SO) (SO) (SO)

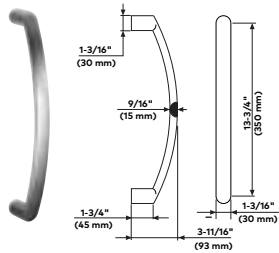

905.530	Set	Back-to-Back		639	703	853
905.330	Ea.	Single Sided		392	431	552

TG 9304 Curved Pull, Radius Standoff, 1-1/4" (32) Diameter, 13-3/4" (349) Center-to-Center

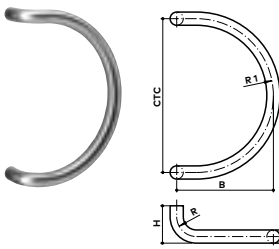

905.569	Set	Back-to-Back		323	355	537
905.369	Ea.	Single Sided		211	232	371
		Ø	1-1/4" (32)			
		R	1-3/4" (44)			
		R1	6-7/8" (175)			
		B	8-11/16" (220)			
		H	3-3/8" (85)			
		CTC	13-3/4" (350)			

TG 9306 Curved Pull, Sharp/Straight Standoff, 1-9/16" (40) Dia. 13-3/4" (349) Center-to-Center

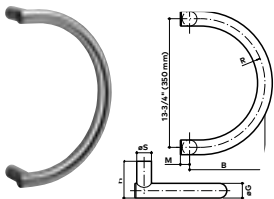

905.611	Set	Back-to-Back		716	788	930
905.411	Ea.	Single Sided		429	472	590
		ØGØS	1-9/16" (40)			
		R	6-7/8" (175)			
		B	8-3/16" (205)			
		H	3-15/16" (100)			
		M	1" (24)			

NOTE: Specify door thickness and desired screwpack.

Fixings for TG Handles to Glass Doors 5/16" (8)-9/16" (15) Thick **700/701** **999**

				(SO)	(SO)
--	--	--	--	------	------

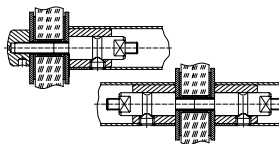

905.900	Ea.	Back-to-Back – M6		24	26
905.902	Ea.	Back-to-Back – M8		24	26
905.905	Ea.	Single Sided – M6		43	47
905.904	Ea.	Single Sided – M8		43	47

Fixings for TG Handles to Wood Doors 1-3/8" (35)-3-15/16" (100) Thick

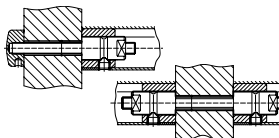

905.901	Ea.	Back-to-Back – M6		26	28
905.903	Ea.	Back-to-Back – M8		26	28
905.907	Ea.	Single Sided – M6		45	49
905.906	Ea.	Single Sided – M8		45	49

Rose Options for TG Pulls





905.971	Ea.	1-9/16" (40) Rose – M6		11	13
905.972	Ea.	1-3/4" (44) Rose – M8		11	13

Net Add \$

POWDER All Custom powder coated orders will include a **net charge** per purchase order. 200

(SO) Special Fabricated/Finish or Special Order; lead time up to 5 weeks.

ARCOS and BEYOND Decorative Pulls

Pulls for 3/8" (10) and 1/2" (12) Glass Doors					Standard Finish \$	Custom Finish \$
Model	Ref. #	U/M	No. Of Fixing Posts	Description	114	999
ARCOS 15-11/16" (398) Length					(SO)	(SO)
	826.500	Set	2F	13-3/4" (350) Center-to-Center	364	578
ARCOS 32-7/16" (824) Length						
	826.510	Set	2F	29-1/2" (750) Center-to-Center	429	857
					107	
BEYOND, Specify Door Thickness					(SO)	
	830.300	Set	2F	17-3/4" (450) Center-to-Center 3/8" (10) or 1/2" (12)	872	1,086
	830.305	Set	2F	23-5/8" (600) Center-to-Center 3/8" (10) or 1/2" (12)	1,011	1,225
	830.310	Set	2F	35-7/16" (900) Center-to-Center 3/8" (10) or 1/2" (12)	1,207	1,635
						Net Add \$
POWDER	All Custom powder coated orders will include a net charge per purchase order.					200

(SO) Special Fabricated/Finish or Special Order; lead time up to 5 weeks.

NOTE: Specify door thickness.

Economy Pulls—Solid & Tubular Pull Handles for 3/8" (10) & 1/2" (12) Glass

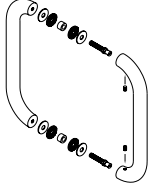
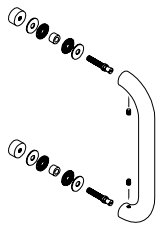
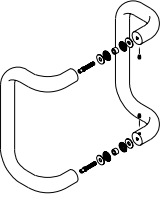
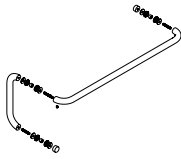
Model	Ref. #	U/M	Description	Finishes \$						
				101	108	109	503/599	600/601	700	701
Solid and Tubular, Back-to-Back, 10" and 12" (Center-to-Center) Handles										
	926.001	Set	10" (254) Solid	62 (1)	65 (1)	65 (SO)	—	268 (SO)	141 (1)	141 (SO)
	926.601	Set	10" (254) Tubular	—	—	—	113 (SO)	—	75 (1)	75 (SO)
	926.004	Set	12" (305) Solid	65 (1)	70 (1)	70 (1)	192 (SO)	482 (SO)	156 (1)	156 (1)
	926.604	Set	12" (305) Tubular	—	—	—	120 (SO)	—	78 (1)	78 (1)
Solid and Tubular, Single Sided, 10" and 12" (Center-to-Center) Handles										
	926.012	Ea.	10" (254) Solid	(SO)	(SO)	(SO)	(SO)	(SO)	(SO)	(SO)
	926.612	Ea.	10" (254) Tubular	38	43	43	—	—	—	—
	926.016	Ea.	12" (305) Solid	—	—	—	—	—	47	47
	926.616	Ea.	12" (305) Tubular	48	51	51	—	—	—	—
Solid and Tubular, Back-to-Back Offset, 10" and 12" (Center-to-Center) Handles										
	926.622	Set	10" (254) Tubular	—	—	—	—	—	94	94
	926.009	Set	12" (305) Solid	75	82	82	—	—	—	—
	926.609	Set	12" (305) Tubular	—	—	—	153	—	102 (1)	102 (SO)
Solid and Tubular, Back-to-Back, 10" and 12" (Center-to-Center) x 27-3/4" Handles										
	926.002	Set	10" x 27-3/4" (254 x 705) Solid	86	96	96	—	—	—	—
	926.602	Set	10" x 27-3/4" (254 x 705) Tubular	—	—	—	—	—	121	121
	926.005	Set	12" x 27-3/4" (305 x 705) Solid	82 (1)	92 (1)	92	—	—	264 (1)	264 (1)
	926.605	Set	12" x 27-3/4" (305 x 705) Tubular	—	—	—	163	—	130 (1)	130 (1)

(1) Non-Fabricated item, 2-day lead time.

(SO) Special Fabricated/Finish or Special Order; lead time up to 5 weeks.

NOTES:

- Tubular handles include a 1-1/4" (32) washer.
- Specify Door thickness.
- Call customer service for door thicknesses 1-3/8"–2-1/2" (34–63) for fastener pack ordering guidance.

DRS Rails, Channels & Accessories
Patch Fittings & Designer Pivots
Offset Hung Patch Fittings
Headers & Accessories
Closers & Hardware
Locksets
Pulls & Handles
Sliding Systems
MANET
Panic Hardware

Finger Pulls and Knobs for 3/8" (10) and 1/2" (12) Glass

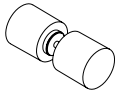
Model	Ref. #	U/M	Description	Finishes \$		
				101	113	199
Finger Pulls				①	①	SO
	907.200	Set	Flush Pull	134	201	201
Knobs				List \$		
	875.022	Ea.	Glass Knob	122 SO		

① Non-Fabricated item, 2-day lead time.

SO Special Fabricated/Finish or Special Order; lead time up to 5 weeks.

Sliding Systems

MUTO Premium and Comfort with Glass Panels	Ordering Guide	140	DRS Rails, Channels & Accessories
	Door Panel Sizing – Height	141	
	Door Panel Sizing – Width	143	
	Ceiling Recessed Mount (CE-R) Applications	144	
MUTO Premium XL 150 DORMOTION		145	Patch Fittings & Designer Pivots
MUTO Premium XL 150		151	
MUTO Premium XL 120 Self-Closing		157	Offset Hung Patch Fittings
MUTO Premium XL 80 Telescopic		163	
MUTO Comfort L 80 DORMOTION		171	Headers & Accessories
MUTO Comfort L 80		176	
Options & Accessories	Locksets, Strikes, and Handles	181	Closers & Hardware
	Roller Accessory Kits	182	
	Gasket Sets	182	Locksets
	Floor Guide	182	
	Track and Cover Extrusions	183	Pulls & Handles
	Wood Adapter Sets	184	
	Cover Clips	184	Sliding Systems
	Endcaps	185	
	DORMOTION Accessory and Start/Stop Kits	185	MANET
	Synchro Accessories	186	
	Self-Closing Accessories	186	Panic Hardware
	Brush Profiles and Seals	186	
	Endstops	187	
	Bumper Sets	187	
	Holder Hook Sets	188	
	Sidelite (Fixed Panel) Sidelite Kits, Extrusions and Accessories	188	
	Recessed Mount Accessories	190	
	E-Lock	190	
	Status Indicator	191	
	Fastener Packs	191	
Tempered Laminated Glass (TLG) Accessories	191		
TLG Gasket Sets	191		
Carrier Locating Tool / Comfort Tool Kit	191		
DRS-120 and RS-120	Ordering Guide – DRS-120 and RS-120	192	
	DRS-120 Ceiling Mount Sliding Systems	193	
	RS-120 Wall and Ceiling Mount Sliding Systems	197	
	RS-120 Accessories and Components	201	
Handle Options	Sliding Applications Handle Options	203	

MUTO Door Panel Sizing

DISCLAIMER

- When sizing MUTO door panels, maximum weight capacity is key. When maximizing door panel width, height, or thickness, one or more of the other dimensions (width, height, or thickness) will require reductions to remain at or below the maximum allowable weight capacity of the specific MUTO sliding unit, within industry codes, standards, or specifications, and within door manufacturer recommendations.
- All formulas apply to both glass and wood panel
- Always refer to Glass Association of North America (GANA) when sizing tempered glass doors.

Door Panel Height Formulas

Wall Mount

$$(XL) GH = CH + 7/8" (22) + X$$

$$(L) GH = CH + 3/4" (18) + X$$

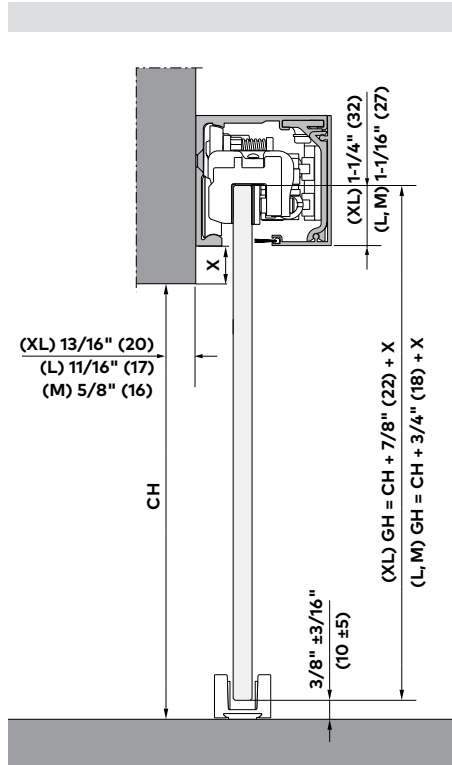

Glass Mount

$$(XL) GH = TH - 1-7/8" (47)$$

$$(L) GH = TH - 1-9/16" (40)$$

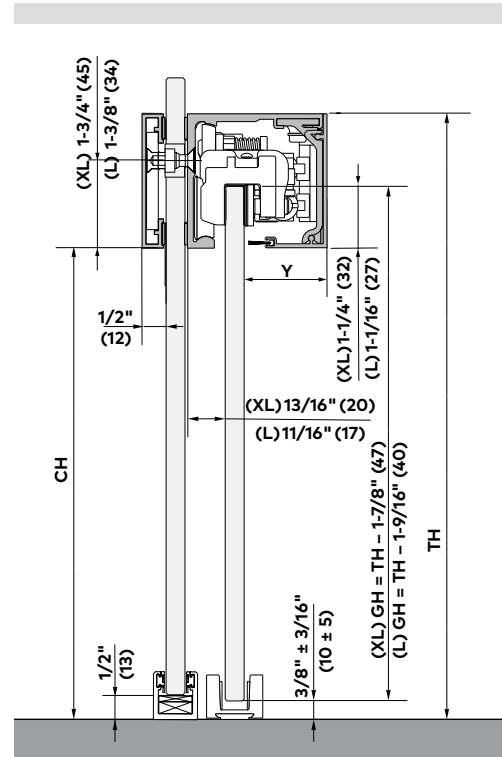

KEY

Wall Mount

- X = Top of Clear Opening to Bottom Edge of Track
- GH = Door (Glass) Height
- CH = Clear Opening Height

Glass Mount

- TH = Finished Floor to Top of Track (Total Height)
- GH = Door (Glass) Height
- CH = Clear Opening Height
- Y = Varies based on glass thickness

Ceiling Mount

- TH = Finished Floor to Top of Track (Total Height)
- GH = Door (Glass) Height

Fixed Panel Ceiling Mount

- TH = Finished Floor to Top of Track (Total Height)
- GH = Door (Glass) Height
- CH = Clear Opening Height
- FPH = Fixed Panel Height
- Y = Varies based on glass thickness

Ceiling Mount

$$(XL) GH = TH - 1-7/8" (47)$$

$$(L) GH = TH - 1-9/16" (40)$$

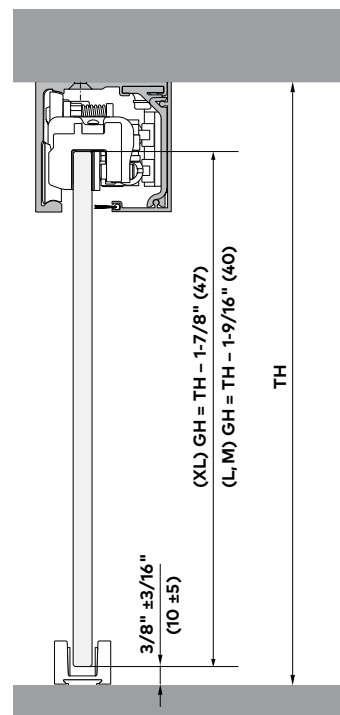

Fixed Panel (Sidelite) Ceiling Mount

$$(XL) GH = TH - 1-7/8" (47) \quad FPH = CH + 1/8" (3)$$

$$(L) GH = TH - 1-9/16" (40) \quad FPH = CH + 1/8" (3)$$

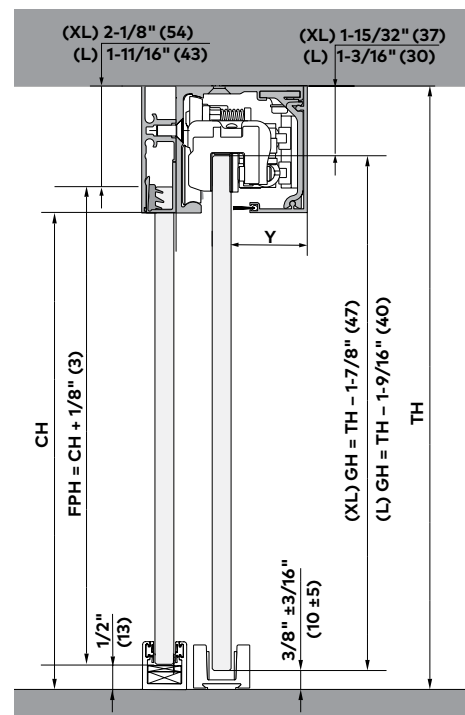

- DRS Rails, Channels & Accessories
- Patch Fittings & Designer Pivots
- Offset Hung Patch Fittings
- Headers & Accessories
- Closers & Hardware
- Locksets
- Pulls & Handles
- Sliding Systems
- MANET
- Panic Hardware

MUTO Door Panel Sizing

KEY

- DW** = Door Panel Width
- CW** = Clear Opening Width
- TL** = Track Length
- FPW** = Fixed Panel Width

Single Door Width Formulas

Single Door Wall Mount (XL, L)

$DW = CW + 2 \times 3/8" (60)^*$

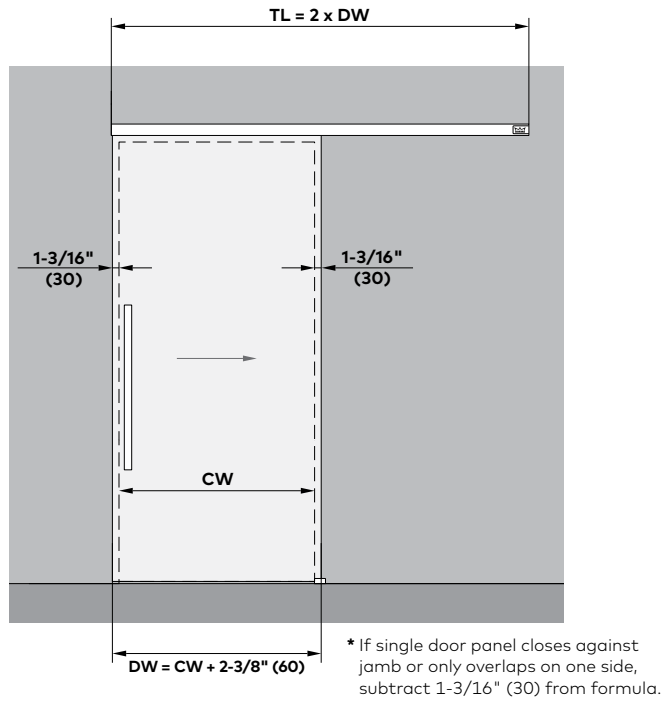

Single Door Ceiling Mount (XL, L)

$DW = CW + 2 \times 3/8" (60)^*$

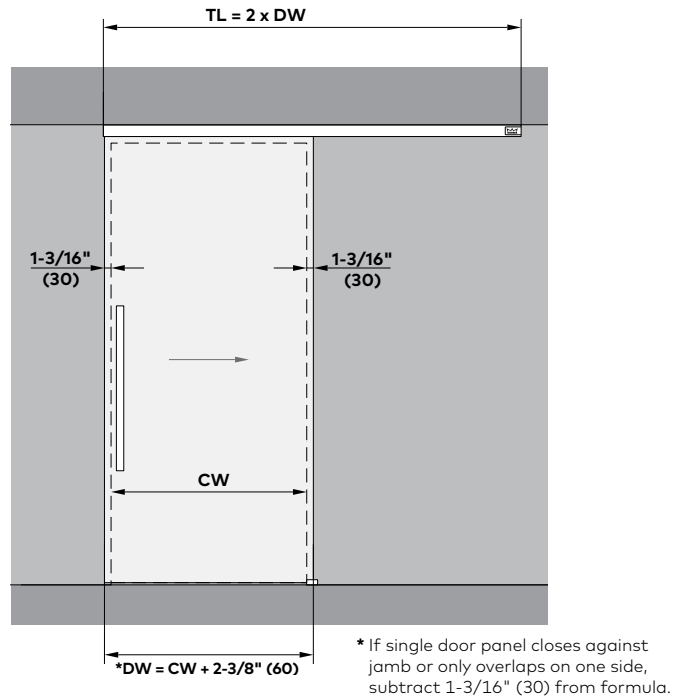

Single Door plus 2 x Fixed Panels (XL, L)

$DW = CW + 1-3/16" (30)$

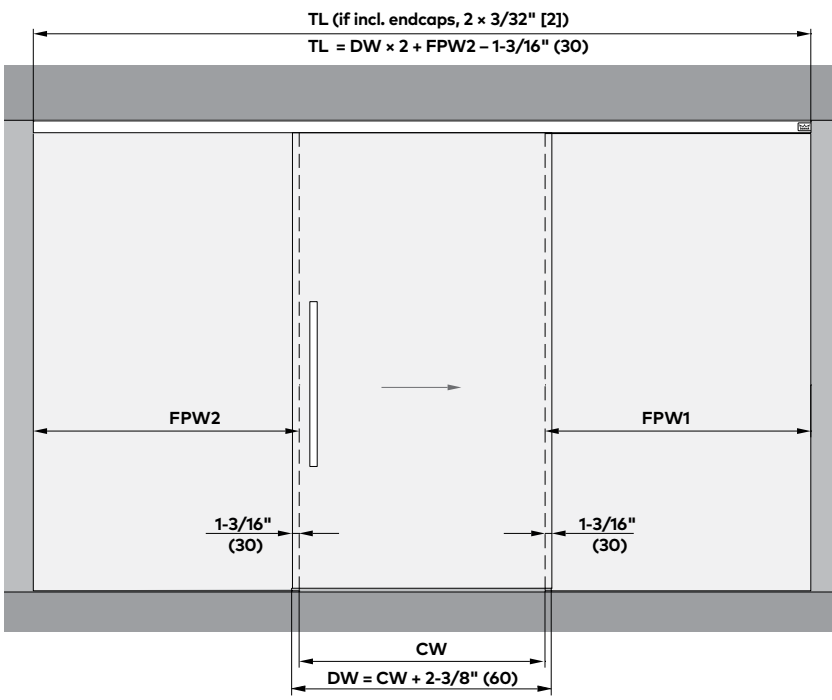

Single Door plus Fixed Panel Closing against Jamb (XL, L)

$DW = CW + 1-3/16" (30)$

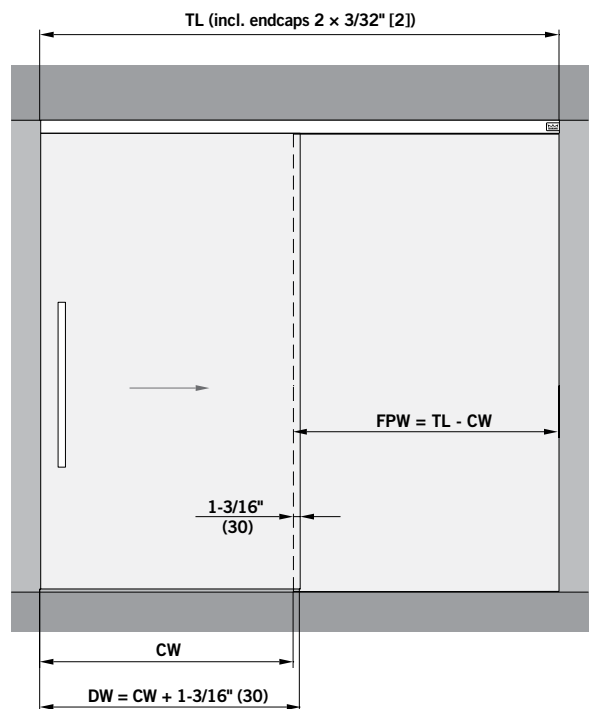

MUTO Door Panel Sizing

DISCLAIMER

- When sizing MUTO door panels, maximum weight capacity is key. When maximizing door panel width, height, or thickness, one or more of the other dimensions (width, height, or thickness) will require reductions to remain at or below the maximum allowable weight capacity of the specific MUTO sliding unit, within industry codes, standards, or specifications, and within door manufacturer recommendations.
- Maximum door panel width will vary depending on type of MUTO, weight, capacity, and options.
- All formulas apply to both glass and wood panel applications.
- Always refer to Glass Association of North America (GANA) when sizing tempered glass doors.

Double Door Ceiling Mount Width Formula

Double Doors with Fixed Panels (XL, L)
 $DW = CW \div 2 + 1-1/16'' (27)$

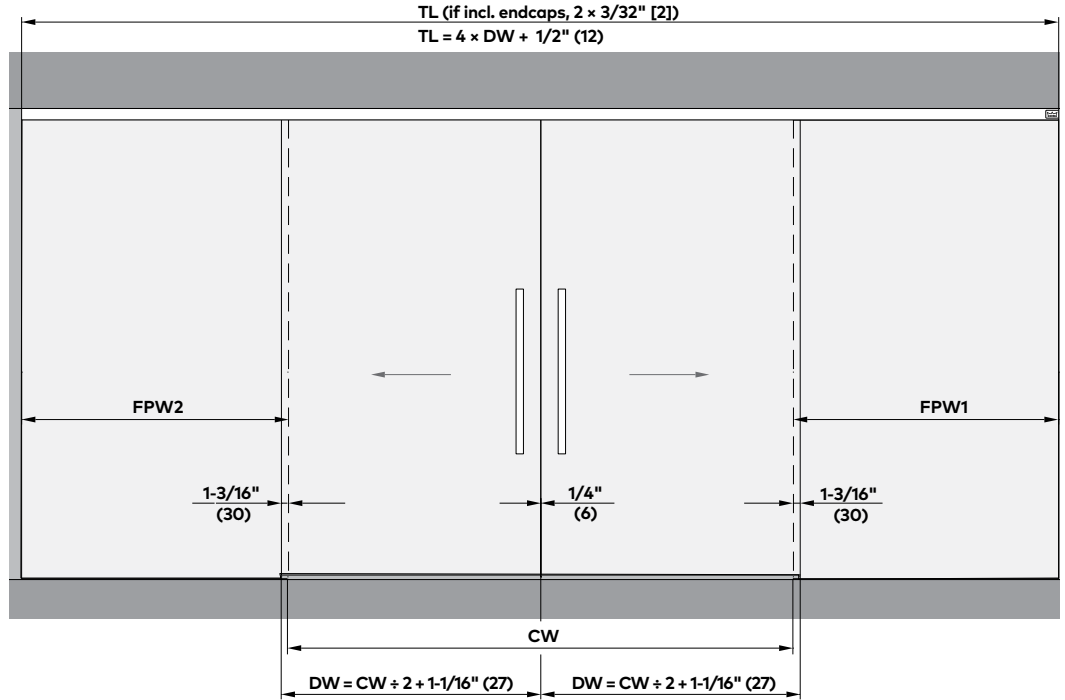

Glass Mount Door Width Formulas

Single Door Glass Mount (XL, L)
 $DW = CW + 2-3/8'' (60)$

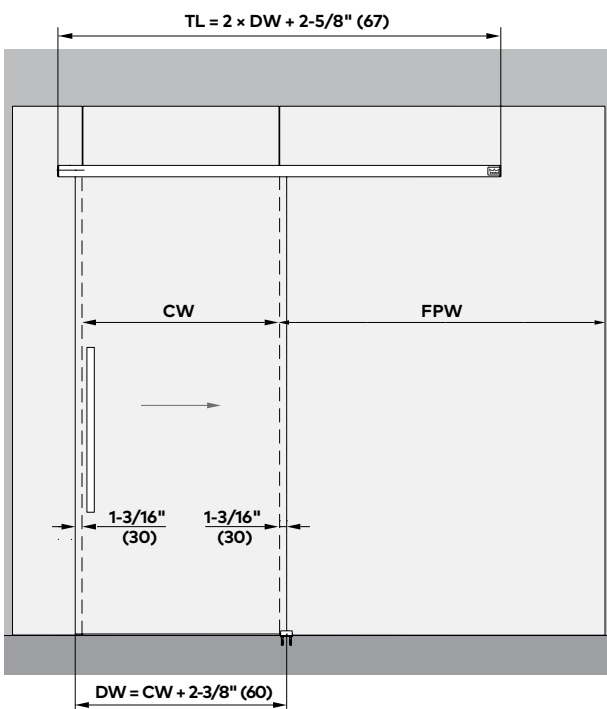

Double Door Glass Mount (XL, L)
 $DW = CW \div 2 + 1-1/16'' (27)$

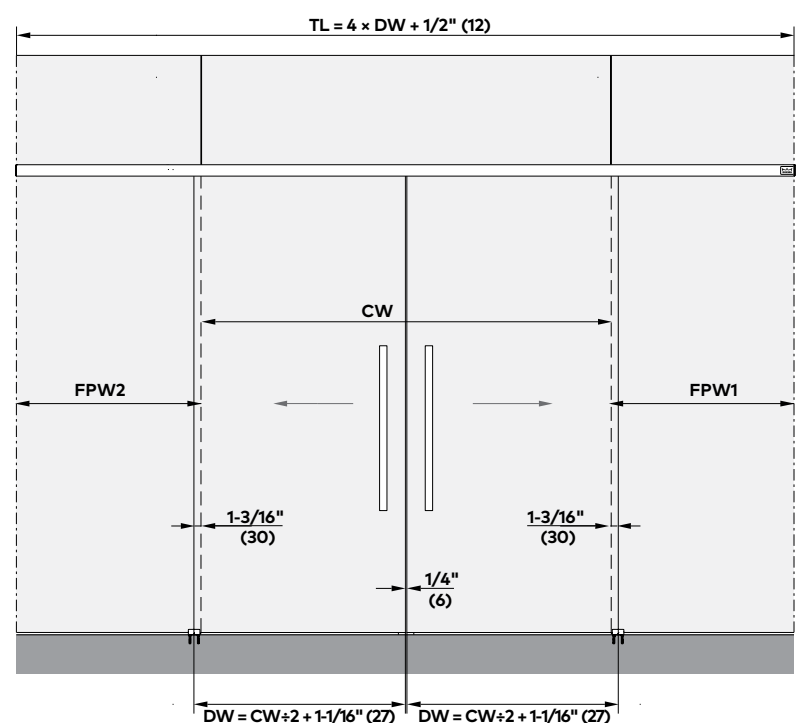

- KEY**
- DW = Door Panel Width
 - CW = Clear Opening Width
 - TL = Track Length
 - FPW = Fixed Panel Width

DRS Rails, Channels & Accessories
 Patch Fittings & Designer Pivots
 Offset Hung Patch Fittings
 Headers & Accessories
 Closers & Hardware
 Locksets
 Pulls & Handles
 Sliding Systems
 MANET
 Panic Hardware

MUTO Ceiling (CE-R) Recessed Mount Applications

Premium XL 150 DORMOTION (DM), XL 150, XL 120 SC Sliding Panels
Concealed or Recessed into Ceiling, Header, Drywall, or Drop Ceiling

Two most common applications

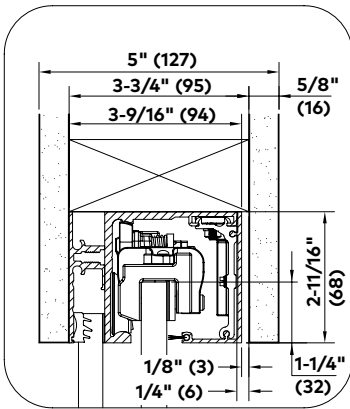

Option 1
Recessed both sides,
Drywall vertically
mounted.

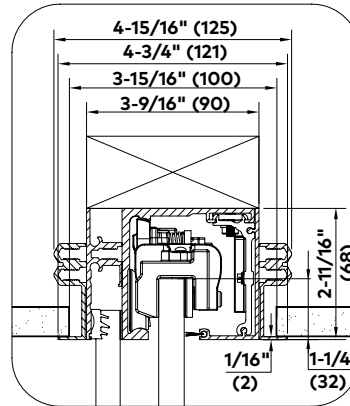

Option 2
Recessed both sides.
(May be drop ceiling
profile 836.820 or
reinforced drywall; drop
ceiling shown.)

Other applications

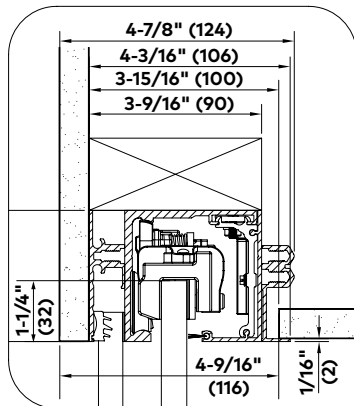

Option 3
Recessed both sides, drop ceiling
profile by drywall.
(Drop ceiling profile 836.820 one side
by flush vertical drywall other side.)

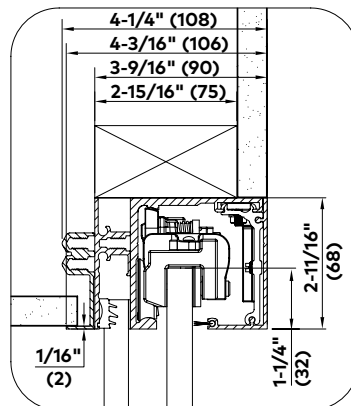

Option 4
Recessed one side only. Drop ceiling
profile by drywall above.
(Drop ceiling profile 836.820 one side
by vertical drywall above.)

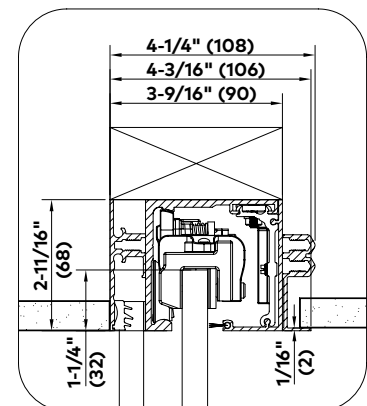

Option 5
Recessed both sides,
Drop ceiling profile by drywall.
(Drop ceiling profile 836.820 one side by
reinforced drywall other side.)

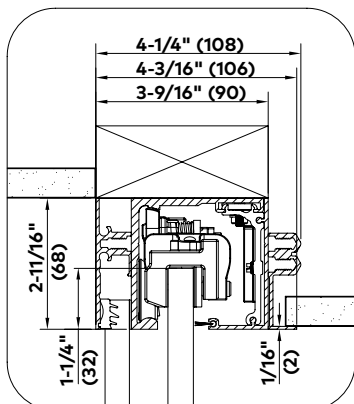

Option 6
Recessed one side only.
Drop ceiling profile by
drywall.
(Drop ceiling profile
836.820 cover side by
reinforced drywall above
sidelite profile.)

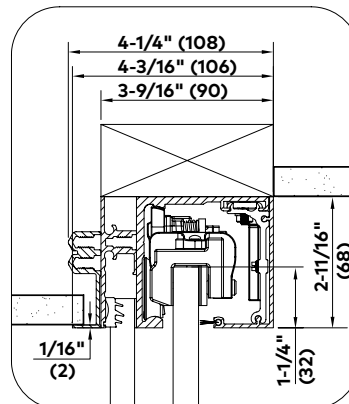



Option 7
Recessed one side only.
Drop ceiling profile by
drywall.
(Drop ceiling profile
836.820 one side by
reinforced drywall above
cover.)

MUTO Premium XL 150 DORMOTION (DM)

One or Two Sliding Panels with One or Two Fixed Panels (Sidelites)

– Ceiling, Surface Mount

Model	Ref. #	U/M	Description	Standard Finishes \$		Special Finishes \$	
				150	113	109/199/399	
Fixed Panel (FP) Mount on Ceiling (CE-S) Surface Mount				③	⑤	⑤⑩	
Single Sliding Panel (1P) with DM with One Fixed Panel (1FP) Complete							
	MTO	236.589	Set Ceiling CE-S 1 x Panel (1P) 1 x Fixed Panel (1FP)	2,204	2,425	2,866	
Single Sliding Panel (1P) with DM with Two Fixed Panels (2FP) Complete							
	MTO	236.591	Set Ceiling CE-S 1 x Panel (1P) 2 x Fixed Panel (2FP)	2,402	2,643	3,123	
		236.531	Ft. Required ADD for units exceeding 154" (3912)	185	200	239	
Two Sliding Panels (2P) with DM with Two Fixed Panels (2FP) Complete							
	MTO	236.593	Set Ceiling CE-S 2 x Panel (2P) 2 x Fixed Panel (2FP)	3,527	3,880	4,585	
		236.531	Ft. Required ADD for units exceeding 154" (3912)	185	200	239	
Ref. #	U/M	Accessory Option			List \$		
836.557	Set	Premium XL 80 DM Acc. Set (Includes DORMOTION cushion and 2 DM start/stops), allows installation to min panel size of 31-7/8" (810) and reduces max door panel weight to 176 lb (80 kg)			See below ¹		
936.461	Set	Premium XL 150/120/80 Wood Door Adaptor Kit (2 m length) (Includes floor guide)			120		
MITER	Ea.	Miter charge list add per cut. (One cut equals one track, cover, and if supplied sidelite), 45° miter joining two MUTO systems is two (2) cuts, list \$ x 2			65		
836.820	Ft.	XL 150/120 Drop Ceiling Connector Profile (Incl. extrusion and fasteners); up to 19'6" (6 m) length			150	113	109/199/399
				23	25	33	

¹ For Ref # 836.557: If in place of XL 150 DM Kit, **List Deduct \$121**, If ordered additionally, **List Add \$463**.

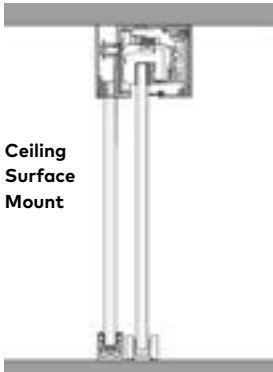

Single Door (1P) Kit shown



Single Sidelite Ceiling Surface Mount (CE-S) Complete Set

- Track Profile (Ceiling)
- Track Mounting Hardware
- Cover Profile and Clips
- Set Roller Carriers
- Unit XL 150 DM
- Set Endcaps
- Cover Brush
- Floor Guide
- Sidelite Profile and Gasket
- Sidelite Filler Profile
- Set Sidelite Endcaps
- U-Channel (incl Gasket/Endcap)
- Sidelite Extrusion Mounting hardware

Double Sidelite Ceiling Surface Mount (CE-S) Complete Set

- Track Profile (Ceiling)
- Track Mounting Hardware
- Cover Profile and Clips
- Set Roller Carriers¹
- Unit XL 150 DM¹
- Set Endcaps
- Cover Brush
- Floor Guide¹
- Sidelite Profile and Gasket
- Sidelite Filler Profile
- Sidelite View Profile
- Set Sidelite Endcaps
- U-Channel (incl Gasket/Endcap)
- Sidelite Extrusion Mounting hardware

¹Two (2) each for two panels (2P)

Technical Details

- Glass thickness: 5/16"-1/2" (8-13)
- Max door panel weight: 330 lb (150 kg)
- Max door panel height: 118" (3000)
- Max door panel width: 57" (1448)
- Min door panel width: 40-3/16" (1020)
- Max track length: 154" (3912)

One Door Panel

- Min clear opening width: 37-13/16" (960)
- Max clear opening width: 54-5/8" (1388)

Two Door Panels

- Min clear opening width: 78-3/16" (1986)
- Max clear opening width: 111-7/8" (2842)

NOTES

- Maximum door panel sizes cannot all be combined in one application. See disclaimer note on pages 141 & 143.
- For door sizes required to exceed published maximum, contact dormakaba Technical Service at 800-523-8483.
- Pairs of sliders with door panel sizes over 38" (965) require two tracks. Joint will be at the center of clear opening.
- MUTO MTO complete set prices shown are priced for up to 154" (3912) length.
- Stock 157" (4 m) extrusion lengths include clamp marks on mounting surface within approximately 1/2"-1-3/4" (13-44) from each end, which may need to be cut in the field.



- ③ Standard or Non-Standard Fabricated; lead time up to 3 days.
- ⑤ Custom Fabricated items ship in up to 5 business days.
- ⑤⑩ Special Fabricated/Finish or Special Order; lead time up to 5 weeks.

DRS Rails, Channels & Accessories
Patch Fittings & Designer Pivots
Offset Hung Patch Fittings
Headers & Accessories
Closers & Hardware
Locksets
Pulls & Handles
Sliding Systems
MANET
Panic Hardware

MUTO Premium XL 150 DORMOTION (DM)

One or Two Sliding Panels with One or Two Fixed Panels (Sidelites)

– Ceiling, Recessed Mount

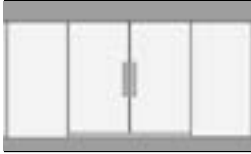
Model	Ref. #	U/M	Description	Standard Finishes \$		Special Finishes \$	
				150	113	Anodized/Powder Coat	
				3	5	50	
Fixed Panel (FP) Mount on Ceiling (CE-R) Recessed Mount							
Single Sliding Panel (1P) with DM with One Fixed Panel (1FP) Complete							
	MTO 236.595	Set	Ceiling CE-R 1 x Panel (1P) 1 x Fixed Panel (1FP)	2,425	2,668	3,152	
Single Sliding Panel (1P) with DM with Two Fixed Panels (2FP) Complete							
	MTO 236.597	Set	Ceiling CE-R 1 x Panel (1P) 2 x Fixed Panel (2FP)	2,643	2,907	3,436	
	236.533	Ft.	Required ADD for units exceeding 157" (4 m)	185	200	239	
Two Sliding Panels (2P) with DM with Two Fixed Panels (2FP) Complete							
	MTO 236.599	Set	Ceiling CE-R 2 x Panel (2P) 2 x Fixed Panel (2FP)	3,880	4,268	5,044	
	236.533	Ft.	Required ADD for units exceeding 157" (4 m)	185	200	239	
Ref. #	U/M	Accessory Option			List \$		
836.557	Set	Premium XL 80 DM Acc. Set (Includes DORMOTION cushion and 2 DM start/stops), allows installation to min panel size of 31-7/8" (810) and reduces max door panel weight to 176 lb (80 kg)			See below ¹		
936.461	Set	Premium XL 150/120 Wood Door Adaptor Kit (2 m length) (Includes floor guide)			120		
MITER	Ea.	Miter charge list add per cut. (One cut equals one track, cover, and if supplied sidelite), 45° miter joining two MUTO systems is two (2) cuts, list \$ x 2			65		
836.820	Ft.	XL 150/120 Drop Ceiling Connector Profile (Incl. extrusion and fasteners); up to 19'6" (6 m) length			150	113	109/199/399
				23	25	33	

- 3 Standard or Non-Standard Fabricated; lead time up to 3 days.
- 5 Custom Fabricated items ship in up to 5 business days.
- 50 Special Fabricated/Finish or Special Order; lead time up to 5 weeks.

¹ For Ref # 836.557: If in place of XL 150 DM Kit, **List Deduct** \$121, If ordered additionally, **List Add** \$463.

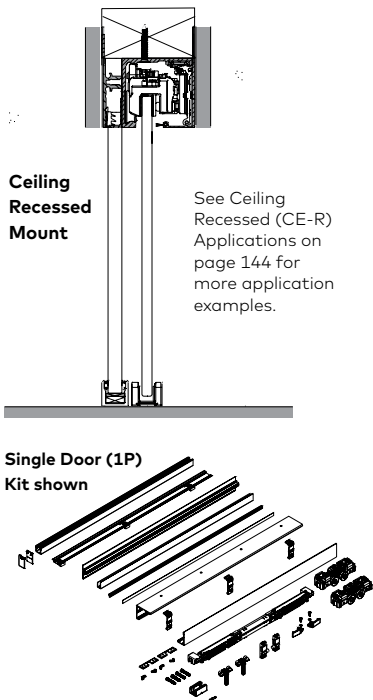

Single Sidelite Ceiling Recessed Mount (CE-R) Complete Set

- Track Profile (Ceiling)
- Track Mounting Hardware
- Cover Profile and Clips
- Set Roller Carriers
- Unit XL 150 DM
- Set Endcaps
- Cover Brush
- Floor Guide
- Sidelite Profile and Gasket
- Sidelite Filler Profile
- Set Sidelite Endcaps
- U-Channel (incl Gasket/ Endcap)
- Sidelite Extrusion
- Mounting hardware
- Recessed Cover Clip
- Recessed Start/Stop plate
- Recessed Hex Bits

Note: Recessed wrench and foam insert sold separately.

Double Sidelite Ceiling Recessed Mount (CE-R) Complete Set

- Track Profile (Ceiling)
- Track Mounting Hardware
- Cover Profile and Clips
- Set Roller Carriers¹
- Unit XL 150 DM¹
- Set Endcaps
- Cover Brush
- Floor Guide¹
- Sidelite Profile and Gasket
- Sidelite Filler Profile
- Sidelite View Profile
- Set Sidelite Endcaps
- U-Channel (incl Gasket/ Endcap)
- Sidelite Extrusion Mounting hardware
- Recessed Cover Clip
- Recessed Start/Stop plate
- Recessed Hex Bits

¹Two (2) each for two panels (2P)

Technical Details

- Glass thickness: 5/16"-1/2" (8-13)
- Max door panel weight: 330 lb (150 kg)
- Max door panel height: 118" (3000)
- Max door panel width: 57" (1448)
- Min door panel width: 40-3/16" (1020)
- Max track length: 157" (3988)

One Door Panel

- Min clear opening width: 37-13/16" (960)
- Max clear opening width: 54-5/8" (1388)

Two Door Panels

- Min clear opening width: 78-3/16" (1986)
- Max clear opening width: 111-7/8" (2842)

NOTES

- Maximum door panel sizes cannot all be combined in one application. See disclaimer note on pages 141 & 143.
- For door sizes required to exceed published maximum, contact dormakaba Technical Service at 800-523-8483.
- Pairs of sliders with door panel sizes over 38" (965) require two tracks. Joint will be at the center of clear opening.
- Recessed MUTO complete set prices shown are priced for up to 157" (3988) length.
- Stock 157" (4 m) extrusion lengths include clamp marks on mounting surface. Marks are typically hidden once installed.

MUTO Premium XL 150 DORMOTION (DM)

One Sliding Panel – Wall and Glass Mounts

Model	Ref. #	U/M	Description	Standard Finishes \$		Special Finishes \$
				150	113	Anodized/Powder Coat
Single Sliding Panel (1P) with DM Complete						(S0)

Wall (W) Mount

	STK	836.510	Set	Wall (W) 1 x Panel (1P)	1,739 ^①	1,913	
		STK Track Length: 157" (4 m)					
	MTO	836.521	Set	Wall (W) 1 x Panel (1P)	1,825 ^③	2,008 ^⑤	2,373

Glass (G) Mount

	MTO	836.525	Set	Glass (G) 1 x Panel (1P)	2,099 ^③	2,309 ^⑤	2,729
---	-----	---------	-----	-----------------------------	--------------------	--------------------	-------

Ref. #	U/M	Accessory Option	List \$
836.557	Set	Premium XL 80 DM Acc. Set (Includes DORMOTION cushion and 2 DM start/stops), allows installation to min panel size of 31-7/8" (810) and reduces max door panel weight to 176 lb (80 kg)	See below ¹
936.461	Set	Premium XL 150/120 Wood Door Adaptor Kit (2 m length) (Includes floor guide)	120
MITER	Ea.	Miter charge list add per cut. (One cut equals one track, cover, and if supplied sidelite), 45° miter joining two MUTO systems is two (2) cuts, list \$ x 2	65

- ① Non-fabricated item; ships in one business day (24 hours).
- ③ Standard or Non-Standard Fabricated; lead time up to 3 days.
- ⑤ Custom Fabricated items ship in up to 5 business days.
- ⑤① Special Fabricated/Finish or Special Order; lead time up to 5 weeks.

¹ For Ref # 836.557: If in place of XL 150 DM Kit, **List Deduct \$121**, If ordered additionally, **List Add \$463**.

Wall Mount

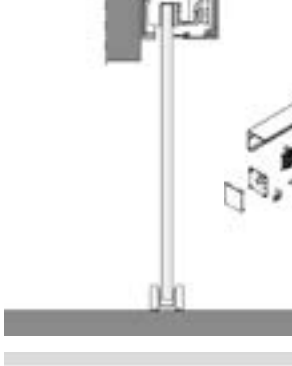

Glass Mount

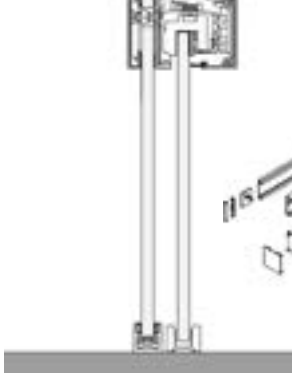

Single Panel Wall Mount (W) Complete Set

- Track Profile (Wall)
- Track Mounting Hardware
- Cover Profile and Clips
- Set Roller Carriers
- Unit XL 150 DM
- Set Endcaps
- Cover Brush
- Floor Guide

Single Panel Glass (G) Mount Complete Set

- Track Profile (Glass)
- Track Mounting Hardware
- Cover Profile and Clips
- Set Roller Carriers
- Unit XL 150 DM
- Set Endcaps
- Cover Brush
- Floor Guide
- Glass Mount Profile
- Set Glass Mount Endcaps
- Glass Mount Gasket
- Glass Mount Brackets
- Glass Mount Hardware

Technical Details

- Glass thickness: 5/16"–1/2" (8–13)
- Max door panel weight: 330 lb (150 kg)
- Max door panel height: 118" (3000)
- Max door panel width: 57" (1448)
- Min door panel width: 40-3/16" (1020)
- Min clear opening width: 37-13/16" (960)
- Max clear opening width: 54-5/8" (1388)

Make to Order (MTO)

- Max track length: 154" (3912)

NOTES

- Maximum door panel sizes cannot all be combined in one application. See disclaimer note on pages 141 & 143.
- For door sizes required to exceed published maximum, contact dormakaba Technical Service at 800-523-8483.
- MUTO MTO Complete set prices shown are priced for up to 154" (3912) length.
- Stock 157" (4 m) extrusion lengths include clamp marks on mounting surface within approximately 1/2"– 1-3/4" (13–44) from each end which may need to be cut in the field.

MUTO Premium XL 150 DORMOTION (DM)

One Sliding Panel

– Ceiling, Surface Mount

Model	Ref. #	U/M	Description	Standard Finishes \$		Special Finishes \$
				150	113	Anodized/Powder Coat
						109/199/399
Single Sliding Panel (1P) with DM Complete						(SO)
Ceiling (CE-S) Surface Mount						
	STK	836.512	Set	Ceiling (CE-S) 1 x Panel (1P)	1,739 ^①	1,913
		STK Track Length: 157" (4 m)				
	MTO	836.523	Set	Ceiling (CE-S) 1 x Panel (1P)	1,825 ^②	2,008 ^③
Ref. #	U/M	Accessory Option			List \$	
836.557	Set	Premium XL 80 DM Acc. Set (Includes DORMOTION cushion and 2 DM start/stops), allows installation to min panel size of 31-7/8" (810) and reduces max door panel weight to 176 lb (80 kg)			See below ¹	
936.461	Set	Premium XL 150/120/80 Wood Door Adaptor Kit (2 m length) (Includes floor guide)			120	
MITER	Ea.	Miter charge list add per cut. (One cut equals one track, cover, and if supplied sidelite), 45° miter joining two MUTO systems is two (2) cuts, list \$ x 2			65	
					150	113
836.820	Ft.	XL 150/120 Drop Ceiling Connector Profile (Incl. extrusion and fasteners); up to 19'6" (6 m) length			23	25
					109/199/399	33

① Non-fabricated item; ships in one business day (24 hours).

② Standard or Non-Standard Fabricated; lead time up to 3 days.

③ Custom Fabricated items ship in up to 5 business days.

④ Special Fabricated/Finish or Special Order; lead time up to 5 weeks.

¹ For Ref # 836.557: If in place of XL 150 DM Kit, **List Deduct \$121**, If ordered additionally, **List Add \$463**.

Ceiling Surface Mount



Single Panel Ceiling Surface Mount (CE-S) Complete Set

- Track Profile (Ceiling)
- Track Mounting Hardware
- Cover Profile and Clips
- Set Roller Carriers
- Unit XL 150 DM
- Set Endcaps
- Cover Brush
- Floor Guide

Technical Details

- Glass thickness: 5/16"–1/2" (8–13)
- Max door panel weight: 330 lb (150 kg)
- Max door panel height: 118" (3000)
- Max door panel width: 57" (1448)
- Min door panel width: 40-3/16" (1020)
- Min clear opening width: 37-13/16" (960)
- Max clear opening width: 54-5/8" (1388)

Make to Order (MTO)



- Max track length: 154" (3912)

NOTES

- Maximum door panel sizes cannot all be combined in one application. See disclaimer note on pages 141 & 143.
- For door sizes required to exceed published maximum, contact dormakaba Technical Service at 800-523-8483.
- MUTO MTO complete set prices shown are priced for up to 154" (3912) length.
- Stock 157" (4 m) extrusion lengths include clamp marks on mounting surface within approximately 1/2"–1-3/4" (13–44) from each end which may need to be cut in the field.

MUTO Premium XL 150 DORMOTION (DM)

Two Sliding Panels – Wall and Glass Mounts

Model	Ref. #	U/M	Description	Standard Finishes \$		Special Finishes \$
				150	113	109/199/399
Two Sliding Panels (2P) with DM Complete (SD)						
Wall (W) Mount						
	836.527	Set	Wall (W) 2 x Panel (2P)	3,468 [ⓐ]	3,815 [ⓐ]	4,508
Glass (G) Mount						
	836.531	Set	Glass (G) 2 x Panel (2P)	3,988 [ⓐ]	4,387 [ⓐ]	5,184
Ref. #	U/M	Accessory Option				List \$
836.557	Set	Premium XL 80 DM Acc. Set (Includes DORMOTION cushion and 2 DM start/stops), allows installation to min panel size of 31-7/8" (810) and reduces max door panel weight to 176 lb (80 kg)				See below ¹
936.461	Set	Premium XL 150/120 Wood Door Adaptor Kit (2 m length) (Includes floor guide)				120
MITER	Ea.	Miter charge list add per cut. (One cut equals one track, cover, and if supplied sidelite), 45° miter joining two MUTO systems is two (2) cuts, list \$ x 2				65

- [ⓐ] Standard or Non-Standard Fabricated; lead time up to 3 days.
- [ⓑ] Custom Fabricated items ship in up to 5 business days.
- [ⓓ] Special Fabricated/Finish or Special Order; lead time up to 5 weeks.

¹ For Ref # 836.557: If in place of XL 150 DM Kit, **List Deduct \$121.**
If ordered additionally, **List Add \$463.**

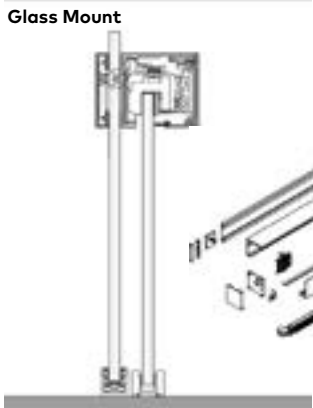
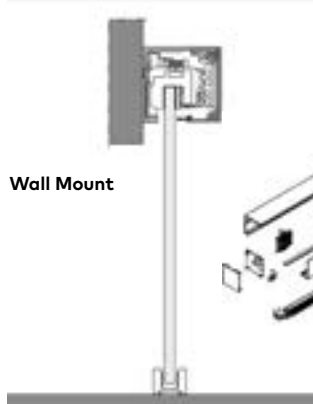

Double Panel Wall Mount (W) Complete Set

- Track Profile (Wall)
- Track Mounting Hardware
- Cover Profile and Clips
- 2 x Set Roller Carriers
- 2 x Unit XL 150 DM
- Set Endcaps
- Cover Brush
- Floor Guides

Double Panel Glass (G) Mount Complete Set

- Track Profile (Wall)
- Track Mounting Hardware
- Cover Profile and Clips
- 2 x Set Roller Carriers
- 2 x Unit XL 150 DM
- Set Endcaps
- Cover Brush
- Floor Guides
- Glass Mount Profile
- Set Glass Mount Endcaps
- Glass Mount Gasket
- Glass Mount Brackets
- Glass Mount Hardware

Technical Details

- Glass thickness: 5/16"–1/2" (8–13)
- Max door panel weight/double door: 2 x 330 lb (150 kg)
- Max door panel width: 57" (1448)
- Min door panel width: 40-3/16" (1020)
- Max door panel height: 118" (3000)
- Min clear opening width: 78-3/16" (1986)
- Max clear opening width: 111-7/8" (2842)
- Max track length: 154" (3912)

NOTES

- Maximum door panel sizes cannot all be combined in one application. See disclaimer note on pages 141 & 143.
- For door sizes required to exceed published maximum, contact dormakaba Technical Service at 800-523-8483.
- Pairs of sliders with door panel sizes over 38" (965) require two tracks. Joint will be at the center of clear opening.
- MUTO MTO complete set prices shown are priced for up to 154" (3912) length.
- Stock 157" (4 m) extrusion lengths include clamp marks on mounting surface within approximately 1/2"–1-3/4" (13–44) from each end which may need to be cut in the field.

DRS Rails, Channels & Accessories
 Patch Fittings & Designer Pivots
 Offset Hung Patch Fittings
 Headers & Accessories
 Closers & Hardware
 Locksets
 Pulls & Handles
 Sliding Systems
 MANET
 Panic Hardware

MUTO Premium XL 150 DORMOTION (DM)

Two Sliding Panels

- Ceiling, Surface Mount

Model	Ref. #	U/M	Description	Standard Finishes \$		Special Finishes \$	
				150	113	Anodized/Powder Paint	
Two Sliding Panels (2P) with DM Complete				3	5	(S0)	
Ceiling (CE-S) Surface Mount							
	MTO	836.529	Set	Ceiling (CE-S) 2 x Panel (2P)	3,468	3,815	4,508
Ref. #	U/M	Accessory Option			List \$		
836.557	Set	Premium XL 80 DM Acc. Set (Includes DORMOTION cushion and 2 DM start/stops), allows installation to min panel size of 31-7/8" (810) and reduces max door panel weight to 176 lb (80 kg)			See below ¹		
936.461	Set	Premium XL 150/120 Wood Door Adaptor Kit (2 m length) (Includes floor guide)			120		
MITER	Ea.	Miter charge list add per cut. (One cut equals one track, cover, and if supplied sidelite), 45° miter joining two MUTO systems is two (2) cuts, list \$ x 2			65		
836.820	Ft.	XL 150/120 Drop Ceiling Connector Profile (Incl. extrusion and fasteners); up to 9'6" (6 m) length			150	113	109/199/399
					23	25	33

- 3** Standard or Non-Standard Fabricated; lead time up to 3 days.
- 5** Custom Fabricated items ship in up to 5 business days.
- (S0)** Special Fabricated/Finish or Special Order; lead time up to 5 weeks.

¹ For Ref # 836.557: If in place of XL 150 DM Kit, **List Deduct \$121**, If ordered additionally, **List Add \$463**.

Ceiling Surface Mount



Double Panel Ceiling Surface Mount (CE-S) Complete Set

- Track Profile (Ceiling)
- Track Mounting Hardware
- Cover Profile and Clips
- 2 x Set Roller Carriers
- 2 x Unit XL 150 DM
- Set Endcaps
- Cover Brush
- Floor Guides

Technical Details



- Glass thickness: 5/16"-1/2" (8-13)
- Max door panel weight/ double door: 2 x 330 lb (150 kg)
- Min door panel width: 40-3/16" (1020)
- Max door panel width: 57" (1448)
- Max door panel height: 118" (3000)
- Min clear opening width: 78-3/16" (1986)
- Max clear opening width: 111-7/8" (2842)
- Max track length: 154" (3912)

NOTES

- Maximum door panel sizes cannot all be combined in one application. See disclaimer note on pages 141 & 143.
- For door sizes required to exceed published maximum, contact dormakaba Technical Service at 800-523-8483.
- Pairs of sliders with door panel sizes over 38" (965) require two tracks. Joint will be at the center of clear opening.
- MUTO MTO complete set prices shown are priced for up to 154" (3912) length.
- Stock 157" (4 m) extrusion lengths include clamp marks on mounting surface within approximately 1/2"- 1-3/4" (13-44) from each end, which may need to be cut in the field.

MUTO Premium XL 150

One or Two Sliding Panels with One or Two Fixed Panels (Sidelites)
 – Ceiling, Surface Mount

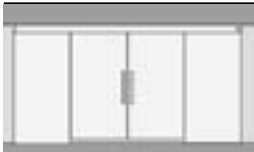
Model	Ref. #	U/M	Description	Standard Finishes \$		Special Finishes \$	
				150	113	Anodized/Powder Coat	
				150	113	109/199/399	
Fixed Panel (FP) Mount on Ceiling (CE-S) Surface Mount				③	⑤	⑤⑩	
Single Sliding Panel (1P) with One Fixed Panel (1FP) Complete							
	MTO	236.588	Set	Ceiling (CE-S) 1 x Panel (1P) 1 x Fixed Panel (1FP)	1,696	1,866	2,205
Single Sliding Panel (1P) with Two Fixed Panels (2FP) Complete							
	MTO	236.590	Set	Ceiling (CE-S) 1 x Panel (1P) 2 x Fixed Panel (2FP)	1,849	2,034	2,403
		236.531	Ft.	Required ADD for units exceeding 154" (3912)	185	200	239
Two Sliding Panels (2P) with Two Fixed Panels (2FP) Complete							
	MTO	236.592	Set	Ceiling (CE-S) 2 x Panel (2P) 2 x Fixed Panel (2FP)	2,714	2,985	3,528
		236.531	Ft.	Required ADD for units exceeding 154" (3912)	185	200	239
Ref. #	U/M	Accessory Option			List \$		
836.560	Set	Premium XL 150 Synchro Kit			731		
936.461	Set	Premium XL 150/120 Wood Door Adaptor Kit (2 m length) (Includes floor guide)			120		
MITER	Ea.	Miter charge list add per cut. (One cut equals one track, cover, and if supplied sidelite), 45° miter joining two MUTO systems is two (2) cuts, list \$ x 2			65		
836.820	Ft.	XL 150/120 Drop Ceiling Connector Profile (Incl. extrusion and fasteners); up to 19'6" (6 m) length			150	113	109/199/399
					23	25	33

- ③ Standard or Non-Standard Fabricated; lead time up to 3 days.
- ⑤ Custom Fabricated items ship in up to 5 business days.
- ⑤⑩ Special Fabricated/Finish or Special Order; lead time up to 5 wks.

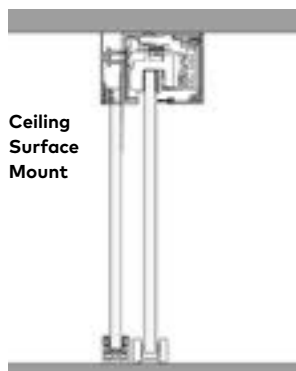

Ceiling Surface Mount

Single Door (1P) Kit shown



Single Panel Ceiling Surface Mount (CE-S) Complete Set

- Track Profile (Ceiling)
- Track Mounting Hardware
- Cover Profile and Clips
- Set Roller Carriers
- Set Endcaps
- Cover Brush
- Floor Guide
- Sidelite Profile and Gasket
- Sidelite Filler Profile
- Set Sidelite Endcaps
- U-Channel (incl Gasket & Endcap)
- Sidelite Extrusion Mounting Hardware

Double Panel Ceiling Surface Mount (CE-S) Complete Set

- Track Profile (Ceiling)
- Track Mounting Hardware
- Cover Profile and Clips
- Set Roller Carriers¹
- Set Endcaps
- Cover Brush
- Floor Guide¹
- Sidelite Profile and Gasket
- Sidelite Filler Profile
- Set Sidelite Endcaps
- U-Channel (incl Gasket & Endcap)
- Sidelite Extrusion Mounting Hardware

¹Two (2) each for two panels (2P)

Technical Details

- Glass thickness: 5/16"-1/2" (8-13)
- Max door panel weight: 330 lb (150 kg)
- Max door panel height: 118" (3000)
- Max door panel width: 57" (1448)
- Min door panel width: 26" (660)
- Max track length: 154" (3912)

One Door Panel

- Min clear opening width: 23-5/8" (600)
- Max clear opening width: 54-3/8" (1381)

Two Door Panels

- Min clear opening width: 49-13/16" (1266)
- Max clear opening width: 111-7/8" (2842)

NOTES



- Maximum door panel sizes cannot all be combined in one application. See disclaimer note on pages 141 & 143.
- For door sizes required to exceed published maximum, contact dormakaba Technical Service at 800-523-8483.
- Pairs of sliders with door panel sizes over 38" (965) require two tracks. Joint will be at the center of clear opening.
- MUTO MTO complete set prices shown are priced for up to 154" (3912) length.
- Stock 157" (4 m) extrusion lengths include clamp marks on mounting surface within approximately 1/2" - 1-3/4" (13-44) from each end, which may need to be cut in the field.

DRS Rails, Channels & Accessories
 Patch Fittings & Designer Pivots
 Offset Hung Patch Fittings
 Headers & Accessories
 Closers & Hardware
 Locksets
 Pulls & Handles
 Sliding Systems
 MANET
 Panic Hardware

MUTO Premium XL 150

One or Two Sliding Panels with One or Two Fixed Panels (Sidelites)

– Ceiling, Recessed Mount

Model	Ref. #	U/M	Description	Standard Finishes \$		Special Finishes \$	
				150	113	109/199/399	
Fixed Panel (FP) Mount on Ceiling (CE-R) Recessed Mount				③	⑤	⑤⑩	
Single Sliding Panel (1P) with One Fixed Panel (1FP) Complete							
	MTO 236.594	Set	Ceiling (CE-R) 1 x Panel (1P) 1 x Fixed Panel (1FP)	1,866	2,052	2,426	
Single Sliding Panel (1P) with Two Fixed Panels (2FP) Complete							
	MTO 236.596	Set	Ceiling (CE-R) 1 x Panel (1P) 2 x Fixed Panel (2FP)	2,034	2,237	2,644	
	MTO 236.533	Ft.	Required ADD for units exceeding 157" (4 m)	185	200	239	
Two Sliding Panels (2P) with Two Fixed Panels (2FP) Complete							
	MTO 236.598	Set	Ceiling (CE-R) 2 x Panel (2P) 2 x Fixed Panel (2FP)	2,985	3,284	3,881	
	MTO 236.533	Ft.	Required ADD for units exceeding 157" (4 m)	185	200	239	
Ref. #	U/M	Accessory Option			List \$		
836.560	Set	Premium XL 150 Synchro Kit			731		
936.461	Set	Premium XL 150/120 Wood Door Adaptor Kit (2 m length) (Includes floor guide)			120		
MITER	Ea.	Miter charge list add per cut. (One cut equals one track, cover, and if supplied sidelite), 45° miter joining two MUTO systems is two (2) cuts, list \$ x 2			65		
				150	113	109/199/399	
836.820	Ft.	XL 150/120 Drop Ceiling Connector Profile (Incl. extrusion and fasteners); up to 19'6" (6 m) length			23	25	33

③ Standard or Non-Standard Fabricated; lead time up to 3 days.
⑤ Custom Fabricated items ship in up to 5 business days.

⑤⑩ Special Fabricated/Finish or Special Order; lead time up to 5 wks.

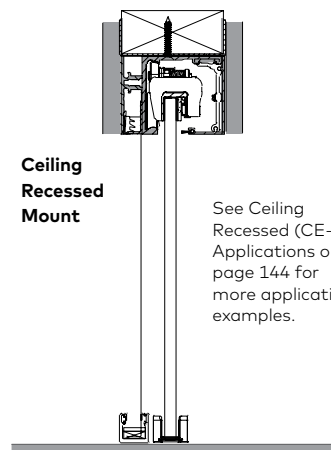

Single Door (1P) Kit shown

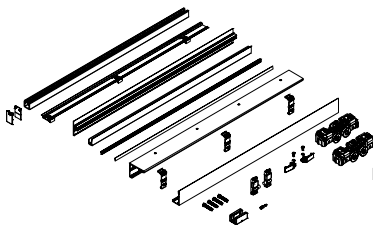

Note: Recessed wrench and foam insert sold separately.

Single Sidelite Ceiling Recessed Mount (CE-R) Complete Set

- Track Profile (Ceiling)
- Track Mounting Hardware
- Cover Profile and Clips
- Set Roller Carriers
- Set Endcaps
- Cover Brush
- Floor Guide
- Sidelite Profile and Gasket
- Sidelite Filler Profile
- Set Sidelite Endcaps
- U-Channel (incl Gasket & Endcap)
- Sidelite Extrusion Mounting Hardware
- Recessed Cover Clip
- Recessed Start/Stop plate
- Recessed Hex Bits

Double Sidelite Ceiling Recessed Mount (CE-R) Complete Set

- Track Profile (Ceiling)
- Track Mounting Hardware
- Cover Profile and Clips
- Set Roller Carriers¹
- Set Endcaps
- Cover Brush
- Floor Guide¹
- Sidelite Profile and Gasket
- Sidelite Filler Profile
- Set Sidelite Endcaps
- U-Channel (incl Gasket & Endcap)
- Sidelite Extrusion Mounting Hardware
- Recessed Cover Clip
- Recessed Start/Stop plate
- Recessed Hex Bits

¹Two (2) each for two panels (2P)

Technical Details

- Glass thickness: 5/16"-1/2" (8-13)
- Max door panel weight: 330 lb (150 kg)
- Max door panel height: 118" (3000)
- Max door panel width: 57" (1448)
- Min door panel width: 26" (660)
- Max track length: 157" (3988)

One Door Panel

- Min clear opening width: 23-5/8" (600)
- Max clear opening width: 54-3/8" (1381)

Two Door Panels

- Min clear opening width: 49-13/16" (1266)
- Max clear opening width: 111-7/8" (2842)

NOTES

- Maximum door panel sizes cannot all be combined in one application. See disclaimer note on pages 141 & 143.
- For door sizes required to exceed published maximum, contact dormakaba Technical Service at 800-523-8483.
- Pairs of sliders with door panel sizes over 38" (965) require two tracks. Joint will be at the center of clear opening.
- Recessed MUTO complete set prices shown are priced for up to 157" (3988) length.
- Stock 157" (4 m) extrusion lengths include clamp marks on mounting surface. Marks typically hidden once installed.

MUTO Premium XL 150

One Sliding Panel – Wall Mount

Model	Ref. #	U/M	Description	Standard Finishes \$		Special Finishes \$
				150	113	109/199/399
Single Sliding Panel (1P) Complete						
Wall (W) Mount						
	STK	236.510	Set	Wall (W) 1 x Panel (1P)	1,231 ①	1,405 ①
		STK Track Length: 157" (4 m)				
	MTO	236.521	Set	Wall (W) 1 x Panel (1P)	1,293 ③	1,422 ⑤
						1,680
Ref. #	U/M	Accessory Option				List \$
936.461	Set	Premium XL 150/120 Wood Door Adaptor Kit (2 m length) (Includes floor guide)				120
MITER	Ea.	Miter charge list add per cut. (One cut equals one track, cover, and if supplied sidelite), 45° miter joining two MUTO systems is two (2) cuts, list \$ x 2				65

- ① Non-fabricated item; ships in one business day (24 hours).
- ③ Standard or Non-Standard Fabricated; lead time up to 3 days.
- ⑤ Custom Fabricated items ship in up to 5 business days.
- ⑤⑩ Special Fabricated/Finish or Special Order; lead time up to 5 weeks.

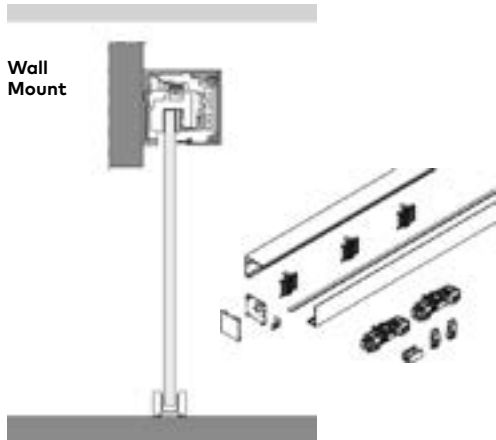

Single Panel Wall Mount (W) Complete Set

- Track Profile (Wall)
- Track Mounting Hardware
- Cover Profile and Clips
- Set Roller Carriers
- Set Endcaps
- Cover Brush
- Floor Guide

Technical Details

- Glass thickness: 5/16" - 1/2" (8-13)
- Max door panel weight: 330 lb (150 kg)
- Max door panel height: 118" (3000)
- Max door panel width: 57" (1448)
- Min door panel width: 26" (660)
- Min clear opening width: 23-5/8" (600)
- Max clear opening width: 54-5/8" (1388)

Make to Order (MTO)

- Max track length: 154" (3912)

NOTES

- Maximum door panel sizes cannot all be combined in one application. See disclaimer note on pages 141 & 143.
- For door sizes required to exceed published maximum, contact dormakaba Technical Service at 800-523-8483.
- MUTO MTO complete set prices shown are priced for up to 154" (3912) length.
- Stock 157" (4 m) extrusion lengths include clamp marks on mounting surface within approximately 1/2" - 1-3/4" (13-44) from each end, which may need to be cut in the field.

DRS Rails, Channels & Accessories
Patch Fittings & Designer Pivots
Offset Hung Patch Fittings
Headers & Accessories
Closers & Hardware
Locksets
Pulls & Handles
Sliding Systems
MANET
Panic Hardware

MUTO Premium XL 150

One Sliding Panel

- Ceiling, Surface Mount

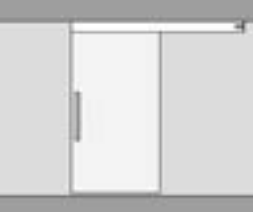
Model	Ref. #	U/M	Description	Standard Finishes \$		Special Finishes \$	
				150	113	Anodized/Powder Paint	
Single Sliding Panel (1P) Complete						109/199/399 ⁽⁵⁰⁾	
Ceiling (CE-S) Surface Mount							
	STK	236.512	Set	Ceiling (CE-S) 1 x Panel (1P)	1,231 ⁽¹⁾	1,405 ⁽¹⁾	
		STK Track Length: 157" (4 m)					
	MTO	236.523	Set	Ceiling (CE-S) 1 x Panel (1P)	1,293 ⁽³⁾	1,422 ⁽³⁾	1,680
Ref. #	U/M	Accessory Option			List \$		
936.461	Set	Premium XL 150/120 Wood Door Adaptor Kit (2 m length) (Includes floor guide)			120		
MITER	Ea.	Miter charge list add per cut. (One cut equals one track, cover, and if supplied sidelite), 45° miter joining two MUTO systems is two (2) cuts, list \$ x 2			65		
836.820	Ft.	XL 150/120 Drop Ceiling Connector Profile (Incl. extrusion and fasteners); up to 19'6" (6 m) length			150	113	109/199/399
					23	25	33

- ⁽¹⁾ Non-fabricated item; ships in one business day (24 hours).
- ⁽³⁾ Standard or Non-Standard Fabricated; lead time up to 3 days.
- ⁽⁵⁾ Custom Fabricated items ship in up to 5 business days.
- ⁽⁵⁰⁾ Special Fabricated/Finish or Special Order; lead time up to 5 weeks.

Ceiling Surface Mount



Single Panel Ceiling Surface Mount (CE-S) Complete Set

- Track Profile (Ceiling)
- Track Mounting Hardware
- Cover Profile and Clips
- Set Roller Carriers
- Set Endcaps
- Cover Brush
- Floor Guide

Technical Details

- Glass thickness: 5/16" - 1/2" (8-13)
- Max door panel weight: 330 lb (150 kg)
- Max door panel height: 118" (3000)
- Max door panel width: 57" (1448)
- Min door panel width: 26" (660)
- Min clear opening width: 23-5/8" (600)
- Max clear opening width: 54-5/8" (1388)

Make to Order (MTO)

- Max track length: 154" (3912)

NOTES

- Maximum door panel sizes cannot all be combined in one application. See disclaimer note on pages 141 & 143.
- For door sizes required to exceed published maximum, contact dormakaba Technical Service at 800-523-8483.
- MUTO MTO complete set prices shown are priced for up to 154" (3912) length.
- Stock 157" (4 m) extrusion lengths include clamp marks on mounting surface within approximately 1/2"-1-3/4" (13-44) from each end, which may need to be cut in the field.



MUTO Premium XL 150

Two Sliding Panels – Wall Mount

Model	Ref. #	U/M	Description	Standard Finishes \$		Special Finishes \$	
				150	113	Anodized/Powder Coat	
Two Sliding Panels (2P) Complete						(SO)	
Wall (W) Mount							
	MTO	236.527	Set	Wall (W) 2 x Panel (2P)	2,338 ③	2,572 ④	3,040
Ref. #	U/M	Accessory Option			List \$		
836.560	Set	Premium XL 150 Synchro Kit			731		
936.461	Set	Premium XL 150/120 Wood Door Adaptor Kit (2 m length) (Includes floor guide)			120		
MITER	Ea.	Miter charge list add per cut. (One cut equals one track, cover, and if supplied sidelite), 45° miter joining two MUTO systems is two (2) cuts, list \$ x 2			65		

- ③ Standard or Non-Standard Fabricated; lead time up to 3 days.
- ④ Custom Fabricated items ship in up to 5 business days.
- ⑤ Special Fabricated/Finish or Special Order; lead time up to 5 weeks.

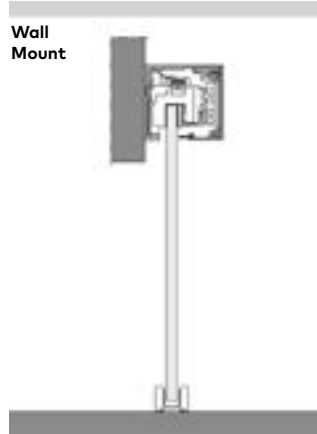

Wall Mount

Double Panel Wall Mount (W) Complete Set

- Track Profile (Wall)
- Track Mounting Hardware
- Cover Profile and Clips
- 2 x Set Roller Carriers
- Set Endcaps
- Cover Brush
- Floor Guides

Technical Details

- Glass thickness: 5/16"-1/2" (8-13)
- Max door panel weight/double door: 2 x 330 lb (150 kg)
- Min door panel width: 26" (660)
- Max door panel width: 57" (1448)
- Max door panel height: 118" (3000)
- Min clear opening width: 47-1/2" (1207)
- Max clear opening width: 111-7/8" (2842)
- Max track length: 154" (3912)

NOTES

- Maximum door panel sizes cannot all be combined in one application. See disclaimer note on pages 141 & 143.
- For door sizes required to exceed published maximum, contact dormakaba Technical Service at 800-523-8483.
- Pairs of sliders with door panel sizes over 38" (965) require two tracks. Joint will be at the center of clear opening.
- MUTO MTO complete set prices shown are priced for up to 154" (3912) length.
- Stock 157" (4 m) extrusion lengths include clamp marks on mounting surface within approximately 1/2"-1-3/4" (13-44) from each end, which may need to be cut in the field.



DRS Rails, Channels & Accessories
Patch Fittings & Designer Pivots
Offset Hung Patch Fittings
Headers & Accessories
Closers & Hardware
Locksets
Pulls & Handles
Sliding Systems
MANET
Panic Hardware

MUTO Premium XL 150

Two Sliding Panels

– Ceiling, Surface Mount

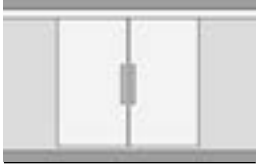
Model	Ref. #	U/M	Description	Standard Finishes \$		Special Finishes \$	
				150	113	Anodized/Powder Paint	
				150	113	109/199/399	
Two Sliding Panels (2P) Complete				3	5	SO	
Ceiling (CE-S) Surface Mount							
	MTO	236.529	Set	Ceiling (CE-S) 2 x Panel (2P)	2,338	2,572	3,040
Ref. #	U/M	Accessory Option			List \$		
836.560	Set	Premium XL 150 Synchro Kit			731		
936.461	Set	Premium XL 150/120 Wood Door Adaptor Kit (2 m length) (Includes floor guide)			120		
MITER	Ea.	Miter charge list add per cut. (One cut equals one track, cover, and if supplied sidelite), 45° miter joining two MUTO systems is two (2) cuts, list \$ x 2			65		
836.820	Ft.	XL 150/120 Drop Ceiling Connector Profile (Incl. extrusion and fasteners); up to 19'6" 6 m) length			150	113	109/199/399
				23	25	33	

- ③ Standard or Non-Standard Fabricated; lead time up to 3 days.
- ⑤ Custom Fabricated items ship in up to 5 business days.
- SO Special Fabricated/Finish or Special Order; lead time up to 5 weeks.

Ceiling Surface Mount



Double Panel Ceiling Surface Mount (CE-S) Complete Set

- Track Profile (Ceiling)
- Track Mounting Hardware
- Cover Profile and Clips
- 2 x Set Roller Carriers
- Set Endcaps
- Cover Brush
- Floor Guides

Technical Details

- Glass thickness: 5/16"–1/2" (8–13)
- Max door panel weight/double door: 2 x 330 lb (150 kg)
- Min door panel width: 26" (660)
- Max door panel width: 57" (1448)
- Max door panel height: 118" (3000)
- Min clear opening width: 49-13/16" (1266)
- Max clear opening width: 111-7/8" (2842)
- Max track length: 154" (3912)

NOTES



- Maximum door panel sizes cannot all be combined in one application. See disclaimer note on pages 141 & 143.
- For door sizes required to exceed published maximum, contact dormakaba Technical Service at 800-523-8483.
- Pairs of sliders with door panel sizes over 38" (965) require two tracks. Joint will be at the center of clear opening.
- MUTO MTO complete set prices shown are priced for up to 154" (3912) length.
- Stock 157" (4 m) extrusion lengths include clamp marks on mounting surface within approximately 1/2"–1-3/4" (13–44) from each end, which may need to be cut in the field.



MUTO Premium XL 120 Self-Closing (SC) DORMOTION (DM)

One or Two Sliding Panels with One or Two Fixed Panels (Sidelites)

– Ceiling, Surface Mount

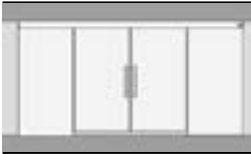
Model	Ref. #	U/M	Description	Standard Finishes \$		Special Finishes \$	
				150	113	Anodized/Powder Coat	
				3	5	50	
Fixed Panel (FP) Mount on Ceiling (CE-S) Surface Mount							
Single Sliding Panel (1P) with Self-Closing (SC) with One Fixed Panel (1FP) Complete							
	MTO	236.690	Set Ceiling (CE-S) RH	2,980	3,279	3,875	
		236.692	Set Ceiling (CE-S) LH	2,980	3,279	3,875	
		(RH shown)	1 x Panel (1P) 1 x Fixed Panel (1FP)				
Single Sliding Panel (1P) with Self-Closing (SC) with Two Fixed Panels (2FP) Complete							
	MTO	236.694	Set Ceiling (CE-S) RH	3,249	3,574	4,223	
		236.696	Set Ceiling (CE-S) LH	3,249	3,574	4,223	
		(RH shown)	1 x Panel (1P) 2 x Fixed Panel (2FP)				
		236.631	Ft. Required ADD for units exceeding 154" (3912)	193	209	248	
Two Sliding Panels (2P) with Self-Closing (SC) with Two Fixed Panels (2FP) Complete							
	MTO	236.698	Set Ceiling (CE-S) 2 x Panel (2P) 2 x Fixed Panel (2FP)	5,198	5,718	6,757	
		236.631	Ft. Required ADD for units exceeding 154" (3912)	193	209	248	
Ref. #	U/M	Accessory Option			List \$		
936.461	Set	Premium XL 150/120 Wood Door Adaptor Kit (2 m length) (Includes floor guide)			120		
836.666	Set	Premium XL 120 SC DMSC Acc Set (Includes DORMOTION cushion and 1 DM start/stop)			342		
MITER	Ea.	Miter charge list add per cut. (One cut equals one track, cover, and if supplied sidelite), 45° miter joining two MUTO systems is two (2) cuts, list \$ x 2			65		
836.820	Ft.	XL 150/120 Drop Ceiling Connector Profile (Incl. extrusion and fasteners); up to 19'6" (6 m) length			150	113	199/399
				23	25	33	

- 3 Standard or Non-Standard Fabricated; lead time up to 3 days.
- 5 Custom Fabricated items ship in up to 5 business days.
- 50 Special Fabricated/Finish or Special Order; lead time up to 5 wks.

NOTES

- Maximum door panel sizes cannot all be combined in one application. See disclaimer note on pages 141 & 143.
- Self-closing units only have DORMOTION feature in the closing cycle.
- For door sizes required to exceed published maximum, contact dormakaba Technical Service at 800-523-8483.
- Pairs of sliders with door panel sizes over 38" (965) require two tracks. Joint will be at the center of clear opening.
- MUTO MTO complete set prices shown are priced for up to 154" (3912) length.
- Stock 157" (4 m) extrusion lengths include clamp marks on mounting surface within approximately 1/2" – 1-3/4" (13–44) from each end, which may need to be cut in the field.

Technical Details

- Glass thickness: 5/16"–1/2" (8–13)
- Max door panel weight: 264 lb (120 kg)
- Max door panel height: 118" (3000)
- Max door panel width: 57" (1448)
- Min door panel width: 33-1/2" (850)
- Max track length: 154" (3912)

One Door Panel

- Min clear opening width: 31-1/8" (791)
- Max clear opening width: 54-5/8" (1388)

Two Door Panels

- Min clear opening width: 64-13/16" (1646)
- Max clear opening width: 111-7/8" (2842)

¹Two (2) each for two panels (2P)

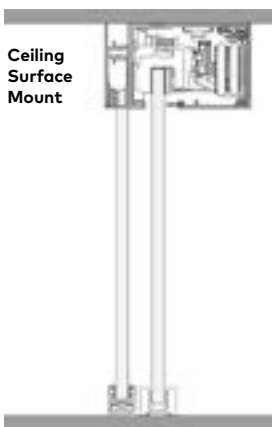

Single Door (1P) Kit shown



Single Sidelite Ceiling Surface Mount (CE-S) Complete Set

- Track Profile (Ceiling)
- Track Mounting Hardware
- Cover Profile and Clips
- Set Roller Carriers
- Unit XL 120 SC
- Unit XL 120 DM
- Set Endcaps
- Cover Brush
- Floor Guide
- Sidelite Profile and Gasket
- Sidelite Filler Profile
- Set Sidelite Endcaps
- U-Channel (incl Gasket & Endcap)
- Sidelite Extrusion Mounting Hardware

Double Sidelite Ceiling Surface Mount (CE-S) Complete Set



- Track Profile (Ceiling)
- Track Mounting Hardware
- Cover Profile and Clips
- Set Roller Carriers¹
- Unit XL 120¹ SC
- Unit XL 120¹ DM
- Set Endcaps
- Cover Brush
- Floor Guide¹
- Sidelite Profile and Gasket
- Sidelite Filler Profile
- Sidelite View Profile
- Set Sidelite Endcaps
- U-Channel (incl Gasket & Endcap)
- Sidelite Extrusion Mounting Hardware

DRS Rails, Channels & Accessories
Patch Fittings & Designer Pivots
Offset Hung Patch Fittings
Headers & Accessories
Closers & Hardware
Locksets
Pulls & Handles
Sliding Systems
MANET
Panic Hardware

MUTO Premium XL 120 Self-Closing (SC) DORMOTION (DM)

One or Two Sliding Panels with One or Two Fixed Panels (Sidelites)

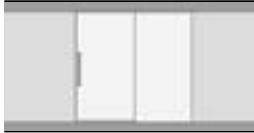
– Ceiling, Recessed Mount

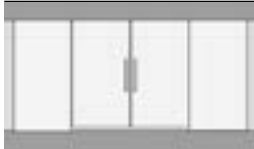
Model	Ref. #	U/M	Description	Standard Finishes \$		Special Finishes \$	
				150	113	Anodized/Powder Coat	
				150	113	199/399	
Fixed Panel (FP) Mount on Ceiling (CE-R) Recessed Mount				③	⑤	⑤D	
Single Sliding Panel (1P) with Self-Closing (SC) with One Fixed Panel (1FP) Complete							
	MTO	236.691	Set	Ceiling (CE-R) RH	3,278	3,606	4,262
		236.693	Set	Ceiling (CE-R) LH 1 x Panel (1P) 1 x Fixed Panel (1FP)	3,278	3,606	4,262
		(RH shown)					
Single Sliding Panel (1P) with Self-Closing (SC) with Two Fixed Panels (2FP) Complete							
	MTO	236.695	Set	Ceiling (CE-R) RH	3,574	3,931	4,646
		236.697	Set	Ceiling (CE-R) LH 1 x Panel (1P) 2 x Fixed Panel (2FP)	3,574	3,931	4,646
			(RH shown)				
		236.633	Ft.	Required ADD for units exceeding 157" (4 m)	193	209	248
Two Sliding Panels (2P) with Self-Closing (SC) with Two Fixed Panels (2FP) Complete							
	MTO	236.699	Set	Ceiling (CE-R) 2 x Panel (2P) 2 x Fixed Panel (2FP)	5,718	6,290	7,433
		236.633	Ft.	Required ADD for units exceeding 157" (4 m)	193	209	248

Ref. #	U/M	Accessory Option	List \$
936.461	Set	Premium XL 150/120 Wood Door Adaptor Kit (2 m length) (Includes floor guide)	120
836.666	Set	Premium XL 120 SC DMSC Acc Set (Includes DORMOTION cushion and 1 DM start/stop)	342
MITER	Ea.	Miter charge list add per cut. (One cut equals one track, cover, and if supplied sidelite), 45° miter joining two MUTO systems is two (2) cuts, list \$ x 2	65
			150 113 199/399
836.820	Ft.	XL 150/120 Drop Ceiling Connector Profile (Incl. extrusion and fasteners); up to 19'6" (6 m) length	23 25 33

③ Standard or Non-Standard Fabricated; lead time up to 3 days. ⑤D Special Fabricated/Finish or Special Order; lead time up to 5 wks.
 ⑤ Custom Fabricated items ship in up to 5 business days.

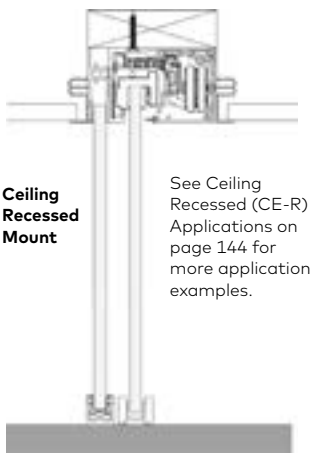

Ceiling Recessed Mount

See Ceiling Recessed (CE-R) Applications on page 144 for more application examples.

Single Door (1P) Kit shown



- Single Sidelite Ceiling Recessed Mount (CE-R) Complete Set**
- Track Profile (Ceiling)
 - Track Mounting Hardware
 - Cover Profile and Clips
 - Set Roller Carriers
 - Unit XL 120 SC
 - Unit XL 120 DM
 - Set Endcaps
 - Cover Brush
 - Floor Guide
 - Sidelite Profile and Gasket
 - Sidelite Filler Profile
 - Set Sidelite Endcaps
 - U-Channel (incl Gasket & Endcap)
 - Sidelite Extrusion Mounting Hardware
 - Recessed Cover Clip
 - Recessed Start/Stop plate
 - Recessed Hex Bits
- Note:** Recessed wrench and foam insert sold separately.

- Double Sidelite Ceiling Recessed Mount (CE-R) Complete Set**
- Track Profile (Ceiling)
 - Track Mounting Hardware
 - Cover Profile and Clips
 - Set Roller Carriers¹
 - Unit XL 120¹ SC
 - Unit XL 120¹ DM
 - Set Endcaps
 - Cover Brush
 - Floor Guide¹
 - Sidelite Profile and Gasket
 - Sidelite Filler Profile
 - Sidelite View Profile
 - Set Sidelite Endcaps
 - U-Channel (incl Gasket & Endcap)
 - Sidelite Extrusion
 - Mounting Hardware
 - Recessed Cover Clip
 - Recessed Start/Stop plate
 - Recessed Hex Bits
- ¹Two (2) each for two panels (2P)

- Technical Details**
- Glass thickness: 5/16"-1/2" (8-13)
 - Max door panel weight: 264 lb (120 kg)
 - Max door panel height: 118" (3000)
 - Max door panel width: 57" (1448)
 - Min door panel width: 33-1/2" (850)
 - Max track length: 157" (3988)
- One Door Panel**
- Min clear opening width: 31-1/8" (791)
 - Max clear opening width: 54-5/8" (1388)
- Two Door Panels**
- Min clear opening width: 64-13/16" (1646)
 - Max clear opening width: 111-7/8" (2842)

- NOTES**
- Maximum door panel sizes cannot all be combined in one application. See disclaimer note on pages 141 & 143.
 - Self-closing units only have DORMOTION feature in the closing cycle.
 - For door sizes required to exceed published maximum, contact dormakaba Technical Service at 800-523-8483.
 - Pairs of sliders with door panel sizes over 38" (965) require two tracks. Joint will be at the center of clear opening.
 - Recessed MUTO complete set prices shown are priced for up to 157" (3988) length.
 - Stock 157" (4 m) extrusion lengths include clamp marks on mounting surface. Marks are typically hidden once installed.

MUTO Premium XL 120 Self-Closing (SC) DORMOTION (DM)

One Sliding Panel

– Wall and Glass Mounts

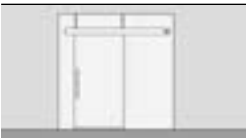
Model	Ref. #	U/M	Description	Standard Finishes \$		Special Finishes \$
				150	113	Anodized/Powder Paint
Single Panel (1P) with Self-Closing (SC) Complete						(SD)
Wall (W) Mount						
	836.620	Set	Wall (W) RH	2,641 ³	2,904 ⁵	3,433
	836.621	Set	Wall (W) LH	2,641 ³	2,904 ⁵	3,433
MTO (RH shown)						
Glass (G) Mount						
	836.624	Set	Glass (G) RH	3,037 ³⁰	3,340 ³⁰	3,957
	836.625	Set	Glass (G) LH	3,037 ³⁰	3,340 ³⁰	3,957
MTO (RH shown)						
Ref. #	U/M	Accessory Option				List \$
936.461	Set	Premium XL 150/120 Wood Door Adaptor Kit (2 m length) (Includes floor guide)				120
836.666	Set	Premium XL 120 SC DMSC Acc Set (Includes DORMOTION cushion and 1 DM start/stop)				342
MITER	Ea.	Miter charge list add per cut. (One cut equals one track, cover, and if supplied sidelite), 45° miter joining two MUTO systems is two (2) cuts, list \$ x 2				65

Wall Mount

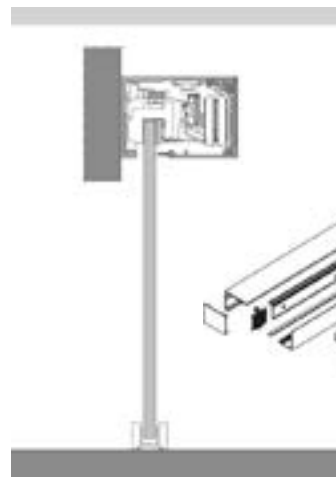

Glass Mount



- ³ Standard or Non-Standard Fabricated; lead time up to 3 days.
- ⁵ Custom Fabricated items ship in up to 5 business days.
- ³⁰ Special Fabricated/Finish or Special Order; lead time up to 5 weeks.

Single Panel Wall Mount (W) Complete Set

- Track Profile (Wall)
- Track Mounting Hardware
- Cover Profile and Clips
- Set Roller Carriers
- Unit XL 120 SC
- Unit XL 120 DM
- Set Endcaps
- Cover Brush
- Floor Guide

Single Panel Glass (G) Mount Complete Set

- Track Profile (Glass)
- Track Mounting Hardware
- Cover Profile and Clips
- Set Roller Carriers
- Unit XL 120 SC
- Unit XL 120 DM
- Set Endcaps
- Cover Brush
- Floor Guide
- Glass Mount Profile
- Set Glass Mount Endcaps
- Glass Mount Gasket
- Glass Mount Brackets
- Glass Mount Hardware

Technical Details

- Glass thickness: 5/16"–1/2" (8–13)
- Max door panel weight: 264 lb (120 kg)
- Max door panel height: 118" (3000)
- Min door panel width: 33-1/2" (850)
- Max door panel width: 57" (1448)
- Min clear opening width: 31-1/8" (791)
- Max clear opening width: 54-5/8" (1388)
- Max track length: 154" (3912)

NOTES

- Maximum door panel sizes cannot all be combined in one application. See disclaimer note on pages 141 & 143.
- Self-closing units only have DORMOTION feature in the closing cycle.
- For door sizes required to exceed published maximum, contact dormakaba Technical Service at 800-523-8483.
- MUTO MTO complete set prices shown are priced for up to 154" (3912) length.
- Stock 157" (4 m) extrusion lengths include clamp marks on mounting surface within approximately 1/2"–1-3/4" (13–44) from each end, which may need to be cut in the field.

DRS Rails, Channels & Accessories
Patch Fittings & Designer Pivots
Offset Hung Patch Fittings
Headers & Accessories
Closers & Hardware
Locksets
Pulls & Handles
Sliding Systems
MANET
Panic Hardware

MUTO Premium XL 120 Self-Closing (SC) DORMOTION (DM)

One Sliding Panel

– Ceiling, Surface Mount

Model	Ref. #	U/M	Description	Standard Finishes \$		Special Finishes \$	
				150	113	Anodized/Powder Paint	
Single Panel (1P) with Self-Closing (SC) Complete						(S)	
Ceiling (CE-S) Surface Mount							
	MTO 836.622	Set	Ceiling (CE-S) RH	2,641 (S)	2,904 (S)	3,433	
	836.623	Set	Ceiling (CE-S) LH	2,641 (S)	2,904 (S)	3,433	
	(RH shown)						
Ref. #	U/M	Accessory Option			List \$		
936.461	Set	Premium XL 150/120 Wood Door Adaptor Kit (2 m length) (Includes floor guide)			120		
836.666	Set	Premium XL 120 SC DMSC Acc Set (Includes DORMOTION cushion and 1 DM start/stop)			342		
MITER	Ea.	Miter charge list add per cut. (One cut equals one track, cover, and if supplied sidelite), 45° miter joining two MUTO systems is two (2) cuts, list \$ x 2			65		
836.820	Ft.	XL 150/120 Drop Ceiling Connector Profile (Incl. extrusion and fasteners); up to 19'6" (6 m) length			150 23	113 25	199/399 33

- (S) Standard or Non-Standard Fabricated; lead time up to 3 days.
- (S) Custom Fabricated items ship in up to 5 business days.
- (S) Special Fabricated/Finish or Special Order; lead time up to 5 weeks.

Ceiling Surface Mount



Single Panel Ceiling Surface Mount (CE-S) Complete Set

- Track Profile (Wall)
- Track Mounting Hardware
- Cover Profile and Clips
- Set Roller Carriers
- Unit XL 120 SC
- Unit XL 120 DM
- Set Endcaps
- Cover Brush
- Floor Guide

Technical Details

- Glass thickness: 5/16"–1/2" (8–13)
- Max door panel weight: 264 lb (120 kg)
- Max door panel height: 118" (3000)
- Min door panel width: 33-1/2" (850)
- Max door panel width: 57" (1448)
- Min clear opening width: 31-1/8" (791)
- Max clear opening width: 54-5/8" (1388)
- Max track length: 154" (3912)



NOTES

- Maximum door panel sizes cannot all be combined in one application. See disclaimer note on pages 141 & 143.
- Self-closing units only have DORMOTION feature in the closing cycle.
- For door sizes required to exceed published maximum, contact dormakaba Technical Service at 800-523-8483.
- MUTO MTO complete set prices shown are priced for up to 154" (3912) length.
- Stock 157" (4 m) extrusion lengths include clamp marks on mounting surface within approximately 1/2"–1-3/4" (13–44) from each end, which may need to be cut in the field.

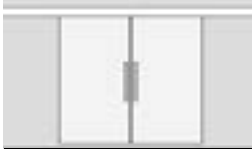

MUTO Premium XL 120 Self-Closing (SC) DORMOTION (DM)

Two Sliding Panels
– Wall and Glass Mounts

Model	Ref. #	U/M	Description	Standard Finishes \$		Special Finishes \$
				150	113	Anodized/Powder Coat
Two Sliding Panels (2P) with Self-Closing (SC) Complete						(SO)
Wall (W) Mount						
	MTO 836.626	Set	Wall (W)	5,016 ³	5,518 ⁵	6,521
Glass (G) Mount						
	MTO 836.628	Set	Glass (G)	5,768 ⁵	6,345 ⁵	7,500
Ref. #	U/M	Accessory Option				List \$
936.461	Set	Premium XL 150/120 Wood Door Adaptor Kit (2 m length) (Includes floor guide)				120
836.666	Set	Premium XL 120 SC DMSC Acc Set (Includes DORMOTION cushion and 1 DM start/stop)				342
MITER	Ea.	Miter charge list add per cut. (One cut equals one track, cover, and if supplied sidelite), 45° miter joining two MUTO systems is two (2) cuts, list \$ x 2				65

- ³ Standard or Non-Standard Fabricated; lead time up to 3 days.
- ⁵ Custom Fabricated items ship in up to 5 business days.
- ^(SO) Special Fabricated/Finish or Special Order; lead time up to 5 weeks.

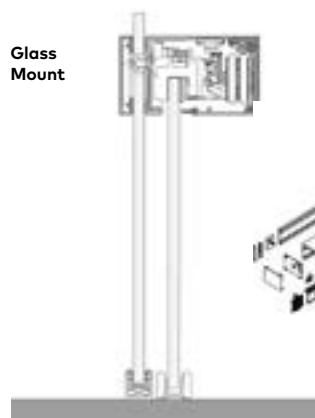
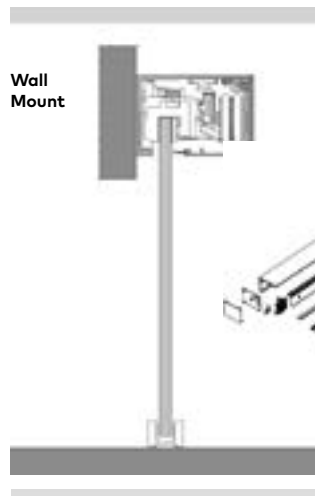

Double Panel Wall Mount (W) Complete Set

- Track Profile (Wall)
- Track Mounting Hardware
- Cover Profile and Clips
- 2 x Set Roller Carriers
- 2 x Unit XL 120 SC
- 2 x Unit XL 120 DM
- Set Endcaps
- Cover Brush
- Floor Guides

Double Panel Glass (G) Mount Complete Set

- Track Profile (Glass)
- Track Mounting Hardware
- Cover Profile and Clips
- 2 x Set Roller Carriers
- 2 x Unit XL 120 SC
- 2 x Unit XL 120 DM
- Set Endcaps
- Cover Brush
- Floor Guides
- Glass Mount Profile
- Set Glass Mount Endcaps
- Glass Mount Gasket
- Glass Mount Brackets
- Glass Mount Hardware

Technical Details

- Glass thickness: 5/16"–1/2" (8–13)
- Max door panel weight/double door: 2 x 264 lb (120 kg)
- Max door panel height: 118" (3000)
- Min door panel width: 33-1/2" (850)
- Max door panel width ea: 57" (1448)
- Min clear opening width: 64-13/16" (1646)
- Max clear opening width: 111-7/8" (2842)
- Max track length: 154" (3912)

NOTES

- Maximum door panel sizes cannot all be combined in one application. See disclaimer note, pages 141 & 143.
- Self-closing units have DORMOTION feature only in the closing cycle.
- For door sizes required to exceed published maximum, contact dormakaba Technical Service at 800-523-8483.
- Pairs of sliders with door panel sizes over 38" (965) require two tracks. Joint will be at the center of clear opening.
- MUTO MTO complete set prices shown are priced for up to 154" (3912) length.
- Stock 157" (4 m) extrusion lengths include clamp marks on mounting surface within approximately 1/2"–1-3/4" (13–44) from each end, which may need to be cut in the field.

MUTO Premium XL 120 Self-Closing (SC) DORMOTION (DM)

Two Sliding Panels

– Ceiling, Surface Mount

Model	Ref. #	U/M	Description	Standard Finishes \$		Special Finishes \$	
				150	113	Anodized/Powder Paint	
Two Sliding Panels (2P) with Self-Closing (SC) Complete				3	5	50	
Ceiling (CE-S) Surface Mount							
	MTO	836.627	Set	Ceiling (CE-S)	5,016	5,518	6,521
Ref. #	U/M	Accessory Option			List \$		
936.461	Set	Premium XL 150/120 Wood Door Adaptor Kit (2 m length) (Includes floor guide)			120		
836.666	Set	Premium XL 120 SC DMSC Acc Set (Includes DORMOTION cushion and 1 DM start/stop)			342		
MITER	Ea.	Miter charge list add per cut. (One cut equals one track, cover, and if supplied sidelite), 45° miter joining two MUTO systems is two (2) cuts, list \$ x 2			65		
					150	113	199/399
836.820	Ft.	XL 150/120 Drop Ceiling Connector Profile (Incl. extrusion and fasteners); up to 19'6" (6 m) length			23	25	33

- ③ Standard or Non-Standard Fabricated; lead time up to 3 days.
- ⑤ Custom Fabricated items ship in up to 5 business days.
- ⑤0 Special Fabricated/Finish or Special Order; lead time up to 5 weeks.

Ceiling Surface Mount



Double Panel Ceiling Surface Mount (CE-S) Complete Set

- Track Profile (Ceiling)
- Track Mounting Hardware
- Cover Profile and Clips
- 2 x Set Roller Carriers
- 2 x Unit XL 120 SC
- 2 x Unit XL 120 DM
- Set Endcaps
- Cover Brush
- Floor Guides

Technical Details

Glass thickness:
5/16"–1/2" (8–13)
Max door panel weight/
double door:
2 x 264 lb (120 kg)
Max door panel height:
118" (3000)
Min door panel width:
33-1/2" (850)
Max door panel width ea:
57" (1448)
Min clear opening width:
64-13/16" (1646)
Max clear opening width:
111-7/8" (2842)
Max track length:
154" (3912)

NOTES



- Maximum door panel sizes cannot all be combined in one application. See disclaimer note on pages 141 & 143.
- Self-closing units have DORMOTION feature only in the closing cycle.
- For door sizes required to exceed published maximum, contact dormakaba Technical Service at 800-523-8483.
- Pairs of sliders with door panel sizes over 38" (965) require two tracks. Joint will be at the center of clear opening.
- MUTO MTO complete set prices shown are priced for up to 154" (3912) length.
- Stock 157" (4 m) extrusion lengths include clamp marks on mounting surface within approximately 1/2"–1-3/4" (13–44) from each end, which may need to be cut in the field.



MUTO Premium XL 80 Telescopic (TEL)

Two or Four Sliding Panels with One or Two Fixed Panels (Sidelites)

- Ceiling, Surface Mount

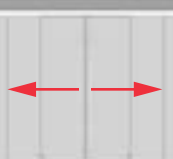
Model	Ref. #	U/M	Description	Standard Finishes \$		Special Finishes \$	
				150	113	199/399	
Fixed Panel (FP) Mount on Ceiling (CE-S) Surface Mount				8W	8W	Q	
Two Sliding Panels (2P) with One Fixed Panel (1FP) Left Hand Opening Complete							
	MTO	836.704	Set	Set 5 (GLS), Set 29 (WD)	4,284	4,579	5,395
		836.728 (WD)		Ceiling (CE-S) 2 x Panels (2P) 1 x Fixed Panel (1FP) Left Hand Opening			
Two Sliding Panels (2P) with One Fixed Panel (1FP) Right Hand Opening Complete							
	MTO	836.706	Set	Set 8 (GLS), Set 32 (WD)	4,284	4,579	5,395
		836.730 (WD)		Ceiling (CE-S) 2 x Panels (2P) 1 x Fixed Panel (1FP) Right Hand Opening			
Four Sliding Panels (4P) with Two Fixed Panels (2FP) Complete							
	MTO	836.711	Set	Set 9 (GLS), Set 33 (WD)	8,569	9,158	10,791
		836.735 (WD)		Ceiling (CE-S) 4 x Panels (4P) 2 x Fixed Panel (2FP)			
				8W	Special Order custom product globally sourced from dormakaba factory; lead time up to 8 weeks.		
				Q	Lead time and pricing quoted on individual basis.		
Ref. #	U/M	Accessory Option			List \$		
WD	Set	Wood panel kit – All appropriate hardware for wood door panels in lieu of glass door panels.			NC		
836.786	Ea.	DM – Optional DORMOTION unit			501		
MITER	Ea.	Miter charge list add per cut. (One cut equals one track, cover, and if supplied sidelite), 45° miter joining two MUTO systems is two (2) cuts, list \$ x 2.			65		
> 3 m	Ft.	For 2P systems, add per foot for track exceeding 118" (3000).			150	113	199/399
					277	277	317

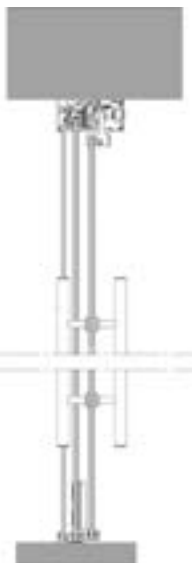

Two Panel Sidelite Ceiling Surface Mount (CE-S) Complete Set

- Track & Mounting Hardware
- Front Cover and Clips
- 2 Sets Roller Carriers
- TEL Cable Set
- TEL DM Kit (Optional)
- Set Endcaps
- Cover Brush
- Moving & Set Floor Guide
- Sidelite Profile, Gasket, and Hardware
- Sidelite Filler Profile
- Set Sidelite Endcaps
- U-Channel (incl Gasket and Endcap)
- Quick Door Carrier
- Sidelite Center Cover
- Quick Door Carrier Cover

Bi-Parting Four Panel Sidelite Ceiling Surface Mount (CE-S) Complete Set

- 2 Tracks & Mounting Hardware
- 2 Front Covers and Clips
- 2 Sets Roller Carriers
- 2 TEL Cable Set
- 2 TEL DM Kit (Optional)
- Set Endcaps
- Cover Brush
- 2 Moving & Set Floor Guide
- Sidelite Profile, Gasket, and Hardware
- Sidelite Filler Profile
- Set Sidelite Endcaps
- U-Channel (incl Gasket and Endcap)
- 2 Quick Door Carriers
- 2 Sidelite Center Cover
- 2 Quick Door Carrier
- CoverTrack Profile (Ceiling)

Technical Details

- Glass thickness: 5/16"-1/2" (8-13.5)
- Max door panel weight each: 2 PNL = 2 x 176 lb (80 kg), 4 PNL = 4 x 176 lb (80 kg)
- Max door panel height: 118" (3000)
- Min door panel width each: 31-3/32" (790) w DM, 23-5/8" (600) wo DM
- Max door panel width glass or wood each: Fast door: 47-1/4" (1200) w/o handle, 49-13/16" (1265) w handle; Slow door: 44-11/16" (1135)
- Max 2P track length: 118" (3000)
- Max 4P track length: 236" (6000)

- For Min./Max. clear opening widths with and without handles, see technical brochure panel sizing chart.

NOTES

- Maximum door panel sizes cannot all be combined in one application. See disclaimer note on page 141 & 143.
- For door sizes required to exceed published maximum, contact dormakaba Technical Service at 800-523-8483.
- Bi-parting XL 80 TEL pairs, (4-panel) will require 2 tracks and covers with a joint at center of clear opening.
- MUTO MTO complete set prices shown are priced for up to 118" (3000) length.

DRS Rails, Channels & Accessories
Patch Fittings & Designer Pivots
Offset Hung Patch Fittings
Headers & Accessories
Closers & Hardware
Locksets
Pulls & Handles
Sliding Systems
MANET
Panic Hardware

MUTO Premium XL 80 Telescopic (TEL)

Two Sliding Panels

– Wall Mount

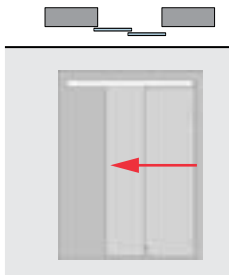
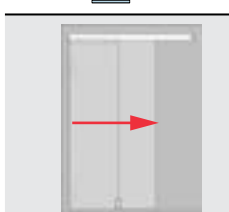
Model	Ref. #	U/M	Description	Standard Finishes \$		Special Finishes \$	
				150	113	Anodized/Powder Coat	
				8W	8W	Q	
Two Sliding Panels (2P) on Wall (W) Mount							
Two Sliding Panels (2P) Left Hand Opening Complete							
	836.701	Set	Set 1 (GLS), Set 25 (WD)	3,728	3,956	4,605	
	836.725 (WD)		Wall (W) 2 x Panels (2P) Left Hand Opening				
Two Sliding Panels (2P) Right Hand Opening Complete							
	836.702	Set	Set 2 (GLS), Set 26 (WD)	3,728	3,956	4,605	
	836.726 (WD)		Wall (W) 2 x Panels (2P) Right Hand Opening				
Ref. #	U/M	Accessory Option			List \$		
WD	Set	Wood panel kit – All appropriate hardware for wood door panels in lieu of glass door panels.			NC		
836.786	Ea.	DM – Optional DORMOTION unit			501		
MITER	Ea.	Miter charge list add per cut. (One cut equals one track, cover, and if supplied sidelite), 45° miter joining two MUTO systems is two (2) cuts, list \$ x 2			65		
> 3 m	Ft.	For 2P systems, add per foot for track exceeding 118" (3000).			150	113	199/399
				277	277	317	

8W Special Order custom product globally sourced from dormakaba factory; lead time up to 8 weeks.

Q Lead time and pricing quoted on individual basis.



Two Panel Wall Mount (W) Complete Set

- Track & Mounting Hardware
- Front Cover and Clips
- 2 Sets Roller Carriers
- TEL Cable Set
- TEL DM Kit (Optional)
- Set Endcaps
- Cover Brush
- Moving & Set Floor Guide
- Sidelite Profile, Gasket, and Hardware
- Sidelite Filler Profile
- Set Sidelite Endcaps
- U-Channel (incl Gasket and Endcap)
- Quick Door Carrier
- Sidelite Center Cover
- Quick Door Carrier Cover

Technical Details

- Glass thickness: 5/16"–1/2" (8–13.5)
- Max door panel weight each.: 2 PNL = 2 x 176 lb (80 kg)
- Max door panel height: 118" (3000)
- Min door panel width each.: 31-3/32" (790) w DM
23-5/8" (600) wo DM
- Max door panel width glass or wood each:
Fast door: 47-1/4" (1200) w/o handle
49-13/16" (1265) w handle
Slow door: 44-11/16" (1135)
- Max 2P track length: 118" (3000)
- For Min./Max. clear opening widths with & without handles; see technical brochure panel sizing chart.

NOTES

- Maximum door panel size cannot all be combined in one application. See disclaimer note on pages 141 & 143.
- For door sizes required to exceed published maximum, contact dormakaba Technical Service at 800-523-8483.
- MUTO MTO complete set prices shown are priced for up to 118" (3000) length.

MUTO Premium XL 80 Telescopic (TEL)

Two Sliding Panels
 – Wall Mount, 90 Jamb°

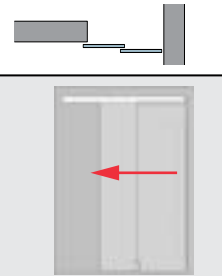
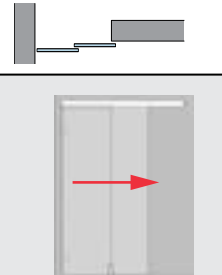
Model	Ref. #	U/M	Description	Standard Finishes \$		Special Finishes \$	
				150	113	Anodized/Powder Coat	
				8W	8W	Q	
Two Sliding Panels (2P) on Wall (W) Mount							
Two Sliding Panels (2P) Left Hand Opening into 90° Complete							
	836.737	Set	Set 1.1 (GLS), Set 25.1 (WD)	3,728	3,956	4,605	
	836.792 (WD)		Wall (W) 2 x Panels (2P) Left Hand Opening 90 ° Jamb				
MUTO							
Two Sliding Panels (2P) Right Hand Opening into 90° Complete							
	836.738	Set	Set 2.1 (GLS), Set 26.1 (WD)	3,728	3,956	4,605	
	836.793 (WD)		Wall (W) 2 x Panels (2P) Right Hand Opening 90 ° Jamb				
MUTO							
Ref. #	U/M	Accessory Option			List \$		
WD	Set	Wood panel kit – All appropriate hardware for wood door panels in lieu of glass door panels.			NC		
836.786	Ea.	DM – Optional DORMOTION unit			501		
MITER	Ea.	Miter charge list add per cut. (One cut equals one track, cover, and if supplied sidelite), 45° miter joining two MUTO systems is two (2) cuts, list \$ x 2			65		
> 3 m	Ft.	For 2P systems, add per foot for track exceeding 118" (3000).			150	113	199/399
				277	277	317	

8W Special Order custom product globally sourced from dormakaba factory; lead time up to 8 weeks.
 Q Lead time and pricing quoted on individual basis.



Two Panel Wall Mount (W) Complete Set

- Track & Mounting Hardware
- Front Cover and Clips
- 2 Sets Roller Carriers
- TEL Cable Set
- TEL DM Kit (Optional)
- Set Endcaps
- Cover Brush
- Moving & Set Floor Guide
- Sidelite Profile, Gasket, and Hardware
- Sidelite Filler Profile
- Set Sidelite Endcaps
- U-Channel (incl Gasket and Endcap)
- Quick Door Carrier
- Sidelite Center Cover
- Quick Door Carrier Cover

Technical Details

- Glass thickness: 5/16" -1/2" (8-13.5)
- Max door panel weight each: 2 PNL = 2 x 176 lb (80 kg)
- Max door panel height: 118" (3000)
- Min door panel width each: 31-3/32" (790) w DM 23-5/8" (600) wo DM
- Max door panel width glass or wood each: Fast door: 47-1/4" (1200) w/o handle 49-13/16" (1265) w handle Slow door: 44-11/16" (1135)
- Max 2P track length: 118" (3000)
- For Min./Max. clear opening widths with and without handles; see technical brochure panel sizing chart

NOTES

- Maximum door panel sizes cannot all be combined in one application. See disclaimer note on pages 141 & 143.
- For door sizes required to exceed published maximum, contact dormakaba Technical Service at 800-523-8483.
- MUTO MTO complete set prices shown are priced for up to 118" (3000) length.

DRS Rails, Channels & Accessories
 Patch Fittings & Designer Pivots
 Offset Hung Patch Fittings
 Headers & Accessories
 Closers & Hardware
 Locksets
 Pulls & Handles
 Sliding Systems
 MANET
 Panic Hardware

MUTO Premium XL 80 Telescopic (TEL)

Two Sliding Panels with Two Fixed Panels (Sidelites)

– Glass Mount

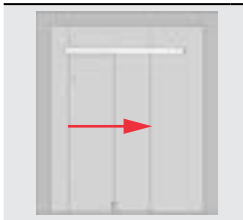
Model	Ref. #	U/M	Description	Standard Finishes \$		Special Finishes \$	
				150	113	Anodized/Powder Coat	
				8W	8W	Q	
Two Fixed Panels (FP) Mount on Glass (G) Mount							
Two Sliding Panels (2P) with Two Fixed Panels (2FP) Left Hand Opening Complete							
	836.707	Set	Set 10 (GLS), Set 34 (WD)	4,325	4,605	5,378	
	836.731 (WD)		Glass (G) 2 × Panels (2P) 2 × Fixed Panels (2FP) Left Hand Opening				
Two Sliding Panels (2P) with Two Fixed Panels (2FP) Right Hand Opening Complete							
	836.708	Set	Set 11 (GLS), Set 35 (WD)	4,325	4,605	5,378	
	836.732 (WD)		Glass (G) 2 × Panels (2P) 2 × Fixed Panels (2FP) Right Hand Opening				
Ref. #	U/M	Accessory Option			List \$		
WD	Set	Wood panel kit – All appropriate hardware for wood door panels in lieu of glass door panels.			NC		
836.786	Ea.	DM – Optional DORMOTION unit			501		
MITER	Ea.	Miter charge list add per cut. (One cut equals one track, cover, and if supplied sidelite), 45° miter joining two MUTO systems is two (2) cuts, list \$ x 2			65		
> 3 m	Ft.	For 2P systems, add per foot for track exceeding 118" (3000).			150	113	199/399
				277	277	317	

8W Special Order custom product globally sourced from dormakaba factory; lead time up to 8 weeks.
 Q Lead time and pricing quoted on individual basis.

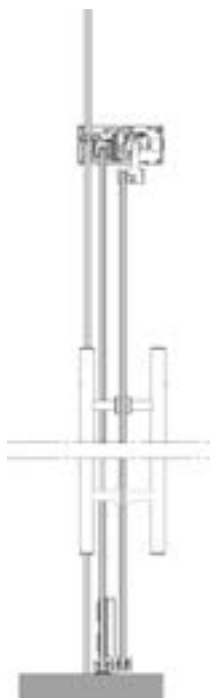

Two Panel Glass (G) Mount Complete Set

- Track & Mounting Hardware
- Front Cover and Clips
- 2 Sets Roller Carriers
- TEL Cable Set
- TEL DM Kit (Optional)
- Set Endcaps
- Cover Brush
- Moving & Set Floor Guide
- Sidelite Profile, Gasket and Hardware
- Sidelite Filler Profile
- Set Sidelite Endcaps
- U-Channel (incl Gasket and Endcap)
- Quick Door Carrier
- Sidelite Center Cover
- Quick Door Carrier Cover
- Glass Mount Profile, Hardware, and gaskets

Technical Details

- Glass thickness: 5/16"–1/2" (8–13.5)
- Max door panel weight Ea.: 2 PNL = 2 × 176 lb (80 kg)
- Max door panel height: 118" (3000)
- Min door panel width Ea.: 31-3/32" (790) w DM 23-5/8" (600) wo DM
- Max door panel width glass or wood each: Fast door: 47-1/4" (1200) w/o handle 49-13/16" (1265) w handle Slow door: 44-11/16" (1135)
- Max 2P track length: 118" (3000)
- For Min./Max. clear opening widths with and without handles; see technical brochure panel sizing chart.



NOTES

- Maximum door panel sizes cannot all be combined in one application. See disclaimer note on pages 141 & 143.
- For door sizes required to exceed published maximum, contact dormakaba Technical Service at 800-523-8483.
- MUTO MTO complete set prices shown are priced for up to 118" (3000) length.

MUTO Premium XL 80 Telescopic (TEL)

Two Sliding Panels

- Ceiling, Surface Mount

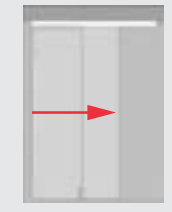
Model	Ref. #	U/M	Description	Standard Finishes \$		Special Finishes \$	
				150	113	Anodized/Powder Coat	
				8W	8W	@	
Two Sliding Panels (2P) on Ceiling (CE-S) Surface Mount							
Two Sliding Panels (2P) Left Hand Opening Complete							
 	MTO	836.703	Set	Set 4 (GLS), Set 28 (WD)	3,728	3,956	4,605
		836.727 (WD)		Ceiling (CE-S) 2 x Panels (2P) Left Hand Opening			
Two Sliding Panels (2P) Right Hand Opening Complete							
 	MTO	836.705	Set	Set 7 (GLS), Set 31 (WD)	3,728	3,956	4,605
		836.729 (WD)		Ceiling (CE-S) 2 x Panels (2P) Right Hand Opening			
Ref. #	U/M	Accessory Option		List \$			
WD	Set	Wood panel kit – All appropriate hardware for wood door panels in lieu of glass door panels.		NC			
836.786	Ea.	DM – Optional DORMOTION unit		501			
MITER	Ea.	Miter charge list add per cut. (One cut equals one track, cover, and if supplied sidelite), 45° miter joining two MUTO systems is two (2) cuts, list \$ x 2		65			
> 3 m	Ft.	For 2P systems, add per foot for track exceeding 118" (3000).		150	113	199/399	
				277	277	317	

8W Special Order custom product globally sourced from dormakaba factory; lead time up to 8 weeks.
 @ Lead time and pricing quoted on individual basis.

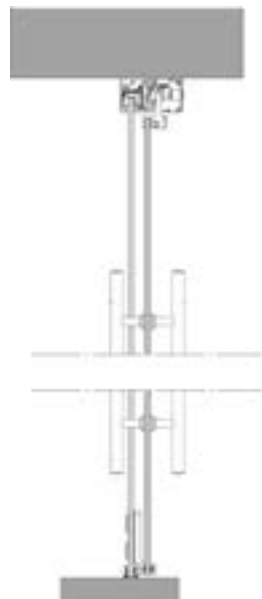

Two Panel Ceiling Surface Mount (CE-S) Complete Set

- Track & Mounting Hardware
- Front Cover and Clips
- 2 Sets Roller Carriers
- TEL Cable Set
- TEL DM Kit (Optional)
- Set Endcaps
- Cover Brush
- Moving & Set Floor Guide
- Sidelite Profile, Gasket, and Hardware
- Sidelite Filler Profile
- Set Sidelite Endcaps
- U-Channel (incl Gasket and Endcap)
- Quick Door Carrier
- Sidelite Center Cover
- Quick Door Carrier Cover

Technical Details

- Glass thickness: 5/16"-1/2" (8-13.5)
- Max door panel weight Ea.: 2 PNL = 2 x 176 lb (80 kg)
- Max door panel height: 118" (3000)
- Min door panel width Ea.: 31-3/32" (790) w DM
23-5/8" (600) wo DM
- Max door panel width glass or wood each:
Fast door:
47-1/4" (1200) w/o handle
49-13/16" (1265) w handle
Slow door: 44-11/16" (1135)
- Max 2P track length: 118" (3000)
- For Min./Max. clear opening widths with and without handles, see technical brochure panel sizing chart.

NOTES

- Maximum door panel sizes cannot all be combined in one application. See disclaimer note on pages 141 & 143.
- For door sizes required to exceed published maximum, contact dormakaba Technical Service at 800-523-8483.
- MUTO MTO complete set prices shown are priced for up to 118" (3000) length.

DRS Rails, Channels & Accessories
 Patch Fittings & Designer Pivots
 Offset Hung Patch Fittings
 Headers & Accessories
 Closers & Hardware
 Locksets
 Pulls & Handles
 Sliding Systems
 MANET
 Panic Hardware

MUTO Premium XL 80 Telescopic (TEL)

Two Sliding Panels

– Ceiling, Surface Mount, 90° Jamb

Model	Ref. #	U/M	Description	Standard Finishes \$		Special Finishes \$
				150	113	Anodized/Powder Coat
				8W	8W	Q
Two Sliding Panels (2P) on Ceiling (CE-S) Surface Mount						

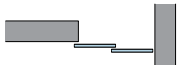

Two Sliding Panels (2P) Left Hand Opening into 90° Jamb Complete

	MTO	836.739	Set	Set 4.1 (GLS), Set 28.1 (WD)	3,728	3,956	4,605
		836.794 (WD)					

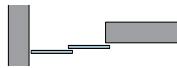

Two Sliding Panels (2P) Right Hand Opening into 90° Jamb Complete

	MTO	836.740	Set	Set 7.1 (GLS), Set 31.1 (WD)	3,728	3,956	4,605
		836.795 (WD)					

Ref. #	U/M	Accessory Option	List \$
WD	Set	Wood panel kit – All appropriate hardware for wood door panels in lieu of glass door panels.	NC
836.786	Ea.	DM – Optional DORMOTION unit	501
MITER	Ea.	Miter charge list add per cut. (One cut equals one track, cover, and if supplied sidelite), 45° miter joining two MUTO systems is two (2) cuts, list \$ x 2	65
> 3 m	Ft.	For 2P systems, add per foot for track exceeding 118" (3000).	
			150 113 199/399
			277 277 317

8W Special Order custom product globally sourced from dormakaba factory; lead time up to 8 weeks.
 Q Lead time and pricing quoted on individual basis.

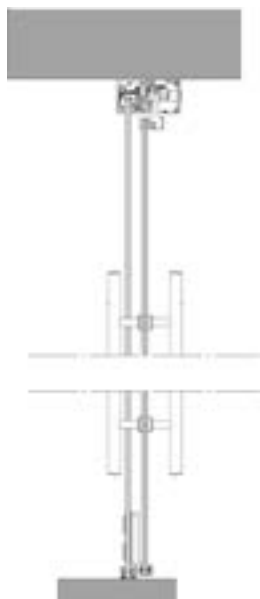

Two Panel Ceiling Surface Mount (CE-S) Complete Set

- Track & Mounting Hardware
- Front Cover and Clips
- 2 Sets Roller Carriers
- TEL Cable Set
- TEL DM Kit (Optional)
- Set Endcaps
- Cover Brush
- Moving & Set Floor Guide
- Sidelite Profile, Gasket, and Hardware
- Sidelite Filler Profile
- Set Sidelite Endcaps
- U-Channel (incl Gasket and Endcap)
- Quick Door Carrier
- Sidelite Center Cover
- Quick Door Carrier Cover

Technical Details

- Glass thickness 5/16"–1/2" (8–13.5)
- Max door panel weight Ea.: 2 PNL = 2 x 176 lb (80 kg)
- Max door panel height: 118" (3000)
- Min door panel width each: 31-3/32" (790) w DM 23-5/8" (600) wo DM
- Max door panel width glass or wood each: Fast door: 47-1/4" (1200) w/o handle 49-13/16" (1265) w handle Slow door: 44-11/16" (1135)
- Max 2P track length: 118" (3000)
- For Min./Max. clear opening widths with and without handles; see technical brochure panel sizing chart.



NOTES

- Maximum door panel sizes cannot all be combined in one application. See disclaimer note on pages 141 & 143.
- For door sizes required to exceed published maximum, contact dormakaba Technical Service at 800-523-8483.
- MUTO MTO complete set prices shown are priced for up to 118" (3000) length.

MUTO Premium XL 80 Telescopic (TEL)

Four Sliding Panels

– Wall Mount

Model	Ref. #	U/M	Description	Standard Finishes \$		Special Finishes \$
				150	113	Anodized/Powder Coat
				150	113	199/399
Four Sliding Panels (4P)				8W	8W	Q
Four Sliding Panels (4P) Wall (W) Mount Complete						
	836.709	Set	Set 3 (GLS), Set 27 (WD)	7,455	7,912	9,210
	836.733 (WD)		Wall (W) 4 x Panels (4P)			
Four Sliding Panels (4P) with Two Fixed Panels (4FP) Glass (G) Mount Complete						
	836.712	Set	Set 12 (GLS), Set 36	8,649	9,210	10,757
	836.736 (WD)		(WD)Glass (G) 4 x Panels (4P) 2 x Fixed Panels (2FP)			
Ref. #	U/M	Accessory Option				List \$
WD	Set	Wood panel kit – All appropriate hardware for wood door panels in lieu of glass door panels.				NC
836.786	Ea.	DM – Optional DORMOTION unit				501
MITER	Ea.	Miter charge list add per cut. (One cut equals one track, cover, and if supplied sidelite), 45° miter joining two MUTO systems is two (2) cuts, list \$ x 2				65

8W Special Order custom product globally sourced from dormakaba factory; lead time up to 8 weeks.
Q Lead time and pricing quoted on individual basis.

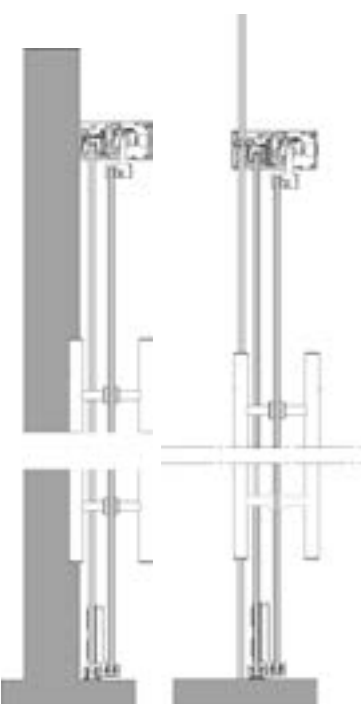

Bi-Parting Four Panel Wall Mount (W) Complete Set

- Track & Mounting Hardware
- Front Cover and Clips
- 2 Sets Roller Carriers
- TEL Cable Set
- TEL DM Kit (Optional)
- Set Endcaps
- Cover Brush
- Moving & Set Floor Guide
- Sidelite Profile, Gasket, and Hardware
- Sidelite Filler Profile
- Sidelite Center Cover
- Quick Door Carrier
- U-Channel (incl Gasket and Endcap)
- Set Sidelite Endcaps

Bi-Parting Four Panel Glass (G) Mount Complete Set

- 2 Tracks & Mounting Hardware
- 2 Front Covers and Clips
- 2 Sets Roller Carriers
- 2 TEL Cable Set
- 2 TEL DM Kit (Optional)
- Set Endcaps
- Cover Brush
- 2 Moving & Set Floor Guide
- Sidelite Profile, Gasket and Hardware
- Sidelite Filler Profile
- Set Sidelite Endcaps
- U-Channel (incl Gasket and Endcap)
- 2 Quick Door Carriers
- 2 Sidelite Center Cover
- 2 Quick Door Carrier Cover
- Glass Mount Profile, Hardware, and Gaskets

Technical Details

- Glass thickness: 5/16"–1/2" (8–13.5)
- Max door panel weight each: 4 PNL = 4 x 176 lb (80 kg)
- Max door panel height: 118" (3000)
- Min door panel width each: 31-3/32" (790) w DM, 23-5/8" (600) wo DM
- Max door panel width glass or wood each: Fast door: 47-1/4" (1200) w/o handle, 49-13/16" (1265) w handle; Slow door: 44-11/16" (1135)
- Max 4P track length: 236" (6000)
- For Min./Max. clear opening widths with and without handles; see technical brochure panel sizing chart.

NOTES

- Maximum door panel sizes cannot all be combined in one application. See disclaimer note on pages 141 & 143.
- For door sizes required to exceed published maximum, contact dormakaba Technical Service at 800-523-8483.
- Bi-parting XL 80 TEL pairs, (4-panel) will require 2 tracks and covers with a joint at center of clear opening.
- MUTO MTO complete set prices shown are priced for up to 118" (3000) length.

DRS Rails, Channels & Accessories
Patch Fittings & Designer Pivots
Offset Hung Patch Fittings
Headers & Accessories
Closers & Hardware
Locksets
Pulls & Handles
Sliding Systems
MANET
Panic Hardware

MUTO Premium XL 80 Telescopic (TEL)

Four Sliding Panels

– Ceiling, Surface Mount

Model	Ref. #	U/M	Description	Standard Finishes \$		Special Finishes \$
				150	113	Anodized/Powder Coat
Four Sliding Panels (4P)				8W	8W	Q

Four Sliding Panels (4P) Ceiling (CE-S) Surface Mount Complete						
	836.710	Set	Set 6 (GLS), Set 30 (WD)	7,455	7,912	9,210
	836.734 (WD)		Ceiling (CE-S) 4 x Panels (4P)			

Ref. #	U/M	Accessory Option	List \$
WD	Set	Wood panel kit – All appropriate hardware for wood door panels in lieu of glass door panels.	NC
836.786	Ea.	DM – Optional DORMOTION unit	501
MITER	Ea.	Miter charge list add per cut. (One cut equals one track, cover, and if supplied sidelite), 45° miter joining two MUTO systems is two (2) cuts, list \$ x 2	65

8W Special Order custom product globally sourced from dormakaba factory; lead time up to 8 weeks.
 Q Lead time and pricing quoted on individual basis.



Bi-Parting Four Panel Ceiling Surface Mount (CE-S) Complete Set

- 2 Tracks & Mounting Hardware
- 2 Front Covers and Clips
- 2 Sets Roller Carriers
- 2 TEL Cable Set
- 2 TEL DM Kit (Optional)
- Set Endcaps
- Cover Brush
- 2 Moving & Set Floor Guide
- Sidelite Profile, Gasket, and Hardware
- Sidelite Filler Profile
- Set Sidelite Endcaps
- U-Channel (incl Gasket and Endcap)
- 2 Quick Door Carriers
- 2 Sidelite Center Cover
- 2 Quick Door Carrier
- CoverTrack Profile (Ceiling)

Technical Details

- Glass thickness: 5/16"–1/2" (8–13.5)
- Max door panel weight each: 4 PNL = 4 x 176 lb (80 kg)
- Max door panel height: 118" (3000)
- Min door panel width each: 31-3/32" (790) w DM 23-5/8" (600) wo DM
- Max door panel width glass or wood each: Fast door: 47-1/4" (1200) w/o handle 49-13/16" (1265) w handle Slow door: 44-11/16" (1135)
- Max 4P track length: 236" (6000)
- For Min./Max. clear opening, widths with and without handles; see technical brochure panel sizing chart



NOTES

- Maximum door panel sizes cannot all be combined in one application. See disclaimer note on pages 141 & 143.
- For door sizes required to exceed published maximum, contact dormakaba Technical Service at 800-523-8483.
- Bi-parting XL 80 TEL pairs, (4-panel) will require 2 tracks and covers with a joint at center of clear opening.
- MUTO MTO complete set prices shown are priced for up to 118" (3000) length.

MUTO Comfort L 80 DORMOTION (DM)

One or Two Sliding Panels with One or Two Fixed Panels (Sidelites)

– Ceiling, Surface Mount

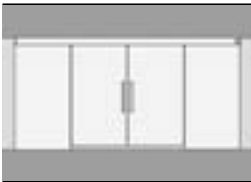
Model	Ref. #	U/M	Description	Standard Finishes \$		Special Finishes \$	
				150	113	Anodized/Powder Coat	
Fixed Panel (FP) Mount on Ceiling (CE-S) Surface Mount				③	⑤	⑩	
Single Sliding Panel (1P) with DM with One Fixed Panel (1FP) Complete							
	MTO	236.389	Set	Ceiling (CE-S) 1 × Panel (1P) 1 × Fixed Panel (1FP)	1,408	1,549	1,830
Single Sliding Panel (1P) with DM with Two Fixed Panels (2FP) Complete							
	MTO	236.391	Set	Ceiling (CE-S) 1 × Panel (1P) 2 × Fixed Panel (2FP)	1,535	1,688	1,996
		236.331	Ft.	Required ADD for units exceeding 154" (3912)	167	181	214
Two Sliding Panels (2P) with DM with Two Fixed Panels (2FP) Complete							
	MTO	236.393	Set	Ceiling (CE-S) 2 × Panel (2P) 2 × Fixed Panel (2FP)	2,253	2,479	2,930
		236.331	Ft.	Required ADD for units exceeding 154" (3912)	167	181	214
Ref. #	U/M	Accessory Option				List \$	
936.261	Set	Comfort L 80 Wood Door Adaptor Kit (2 m length) (Includes floor guide)				107	
MITER	Ea.	Miter charge list add per cut. (One cut equals one track, cover, and if supplied sidelite), 45° miter joining two MUTO systems is two (2) cuts, list \$ x 2				65	

- ③ Standard or Non-Standard Fabricated; lead time up to 3 days.
- ⑤ Custom Fabricated items ship in up to 5 business days.
- ⑩ Special Fabricated/Finish or Special Order; lead time up to 5 weeks.

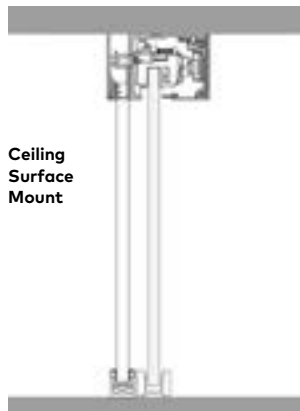

Ceiling Surface Mount

Single Sidelite Ceiling Surface Mount (CE-S) Complete Set

- Track Profile (Ceiling)
- Track Mounting Hardware
- Cover Profile and Clips
- Set Roller Carriers
- Unit L 80 DM
- Set Endcaps
- Cover Brush
- Floor Guide
- Sidelite Profile and Gasket
- Sidelite Filler Profile
- Set Sidelite Endcaps
- U-Channel (incl Gasket/Endcap)
- Sidelite Extrusion
- Mounting Hardware

Double Sidelite Ceiling Surface Mount (CE-S) Complete Set

- Track Profile (Ceiling)
- Track Mounting Hardware
- Cover Profile and Clips
- Set Roller Carriers¹
- Unit L 80 DM¹
- Set Endcaps
- Cover Brush
- Floor Guide¹
- Sidelite Profile and Gasket
- Sidelite Filler Profile
- Sidelite View Profile
- Set Sidelite Endcaps
- U-Channel (incl Gasket/Endcap)
- Sidelite Extrusion
- Mounting Hardware

¹Two (2) each for two panels (2P)

Technical Details

- Glass thickness: 5/16"–1/2" (8–13)
- Max door panel weight: 176 lb (80 kg)
- Max door panel height: 118" (3000)
- Max door panel width: 57" (1448)
- Min door panel width: 39" (990)
- Max track length: 154" (3912)

One Door Panel

- Min clear opening width: 36-5/8" (930)
- Max clear opening width: 61-5/8" (1566)

Two Door Panels

- Min clear opening width: 75-13/16" (1926)
- Max clear opening width: 111-7/8" (2842)

NOTES

- Maximum door panel sizes cannot all be combined in one application. See disclaimer note on pages 141 & 143.
- For door sizes required to exceed published maximum, contact dormakaba Technical Service at 800-523-8483.
- Pairs of sliders with door panel sizes over 38" (965) require two tracks. Joint will be at the center of clear opening.
- MUTO MTO Complete set prices shown are priced for up to 154" (3912) length.
- Stock 157" (4 m) extrusion lengths include clamp marks on mounting surface within approximately 1/2"–1-3/4" (13–44) from each end which may need to be cut in the field.





Single Door (1P) Kit shown

DRS Rails, Channels & Accessories
Patch Fittings & Designer Pivots
Offset Hung Patch Fittings
Headers & Accessories
Closers & Hardware
Locksets
Pulls & Handles
Sliding Systems
MANET
Panic Hardware

MUTO Comfort L 80 DORMOTION (DM)

One Sliding Panel

– Wall and Glass Mounts

Model	Ref. #	U/M	Description	Standard Finishes \$		Special Finishes \$
				150	113	Anodized/Powder Paint
				199/399		
Single Sliding Panel (1P) with DM Complete						(S0)
Wall (W) Mount						
	MTO 236.326	Set	Wall (W) 1 x Panel (1P)	1,093 (S)	1,202 (S)	1,421
Glass (G) Mount						
	MTO 236.328	Set	Glass (G) 1 x Panel (1P)	1,257 (S)	1,383 (S)	1,634
Ref. #	U/M	Accessory Option				List \$
936.261	Set	Comfort L 80 Wood Door Adaptor Kit (2 m length) (Includes floor guide)				107
MITER	Ea.	Miter charge list add per cut. (One cut equals one track, cover, and if supplied sidelite), 45° miter joining two MUTO systems is two (2) cuts, list \$ x 2				65

- (S) Standard or Non-Standard Fabricated; lead time up to 3 days.
- (S) Custom Fabricated items ship in up to 5 business days.
- (S0) Special Fabricated/Finish or Special Order; lead time up to 5 weeks.

Wall Mount

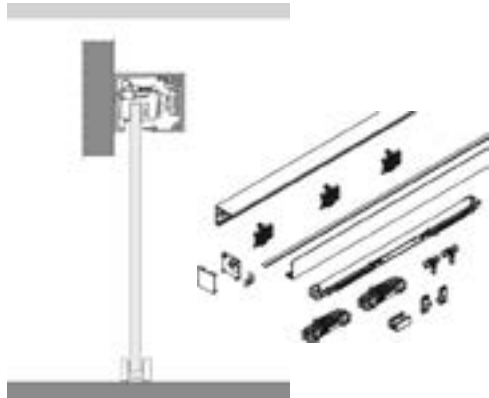

Glass Mount

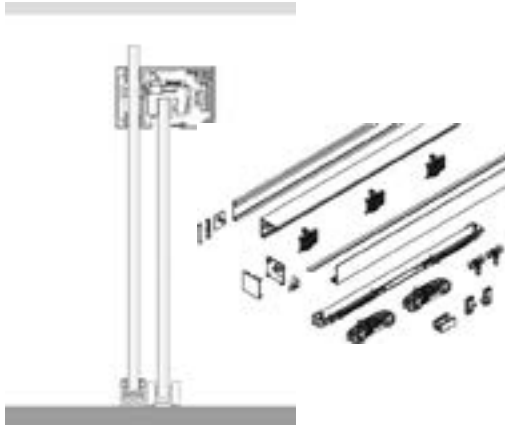

Single Panel Wall Mount (W) Complete Set

- Track Profile (Wall)
- Track Mounting Hardware
- Cover Profile and Clips
- Set Roller Carriers
- Unit L 80 DM
- Set Endcaps
- Cover Brush
- Floor Guide

Single Panel Glass (G) Mount Complete Set

- Track Profile (Glass)
- Track Mounting Hardware
- Cover Profile and Clips
- Set Roller Carriers
- Unit L 80 DM
- Set Endcaps
- Cover Brush
- Floor Guide
- Glass Mount Profile
- Set Glass Mount Endcaps
- Glass Mount Gasket
- Glass Mount Brackets
- Glass Mount Hardware

Technical Details

- Glass thickness: 5/16" -1/2" (8-13)
- Max door panel weight: 176 lb (80 kg)
- Max door panel height: 118" (3000)
- Max door panel width: 57" (1448)
- Min door panel width: 39" (990)
- Min clear opening width: 36-5/8" (930)
- Max clear opening width: 54-5/8" (1388)
- Make to Order (MTO)**
- Max track length: 154" (3912)

NOTES

- Maximum door panel sizes cannot all be combined in one application. See disclaimer note on pages 141 & 143.
- For door sizes required to exceed published maximum, contact dormakaba Technical Service at 800-523-8483.
- MUTO MTO Complete set prices shown are priced for up to 154" (3912) length.
- Stock 157" (4 m) extrusion lengths include clamp marks on mounting surface within approximately 1/2"-1-3/4" (13-44) from each end which may need to be cut in the field.

MUTO Comfort L 80 DORMOTION (DM)

One Sliding Panel

- Ceiling, Surface Mount

Model	Ref. #	U/M	Description	Standard Finishes \$		Special Finishes \$
				150	113	Anodized/Powder Paint
Single Sliding Panel (1P) with DM Complete						(S0)
Ceiling (CE-S) Surface Mount						
	MTO 236.327	Set	Ceiling (CE-S) 1 x Panel (1P)	1,093 ³	1,202 ⁵	1,421
Ref. #	U/M	Accessory Option				List \$
936.261	Set	Comfort L 80 Wood Door Adaptor Kit (2 m length) (Includes floor guide)				107
MITER	Ea.	Miter charge list add per cut. (One cut equals one track, cover, and if supplied sidelite), 45° miter joining two MUTO systems is two (2) cuts, list \$ x 2				65

- ³ Standard or Non-Standard Fabricated; lead time up to 3 days.
- ⁵ Custom Fabricated items ship in up to 5 business days.
- (S0) Special Fabricated/Finish or Special Order; lead time up to 5 weeks.

Ceiling Surface Mount



Single Panel Ceiling Surface Mount (CE-S) Complete Set

- Track Profile (Ceiling)
- Track Mounting Hardware
- Cover Profile and Clips
- Set Roller Carriers
- Unit L 80 DM
- Set Endcaps
- Cover Brush
- Floor Guide

Technical Details

- Glass thickness: 5/16"-1/2" (8-13)
- Max door panel weight: 176 lb (80 kg)
- Max door panel height: 118" (3000)
- Max door panel width: 57" (1448)
- Min door panel width: 39" (990)
- Min clear opening width: 36-5/8" (930)
- Max clear opening width: 54-5/8" (1388)

Make to Order (MTO)

- Max track length: 154" (3912)

NOTES

- Maximum door panel sizes cannot all be combined in one application. See disclaimer note on pages 141 & 143.
- For door sizes required to exceed published maximum, contact dormakaba Technical Service at 800-523-8483.
- MUTO MTO Complete set prices shown are priced for up to 154" (3912) length.
- Stock 157" (4 m) extrusion lengths include clamp marks on mounting surface within approximately 1/2"-1-3/4" (13-44) from each end which may need to be cut in the field.



DRS Rails, Channels & Accessories

Patch Fittings & Designer Pivots

Offset Hung Patch Fittings

Headers & Accessories

Closers & Hardware

Locksets

Pulls & Handles

Sliding Systems



MANET

Panic Hardware

MUTO Comfort L 80 DORMOTION (DM)

Two Sliding Panels

– Wall and Glass Mounts

Model	Ref. #	U/M	Description	Standard Finishes \$		Special Finishes \$	
				150	113	Anodized/Powder Coat	
				150	113	199/399	
Two Sliding Panels (2P) with DM Complete						(S)	
Wall (W) Mount							
	MTO	836.329	Set	Wall (W) 2 x Panel (2P)	2,077 ³	2,285 ⁵	2,700
Glass (G) Mount							
	MTO	836.331	Set	Glass (G) 2 x Panel (2P)	2,389 ⁶	2,628 ⁶	3,105
Ref. #	U/M	Accessory Option				List \$	
936.261	Set	Comfort L 80 Wood Door Adaptor Kit (2 m length) (Includes floor guide)				107	
MITER	Ea.	Miter charge list add per cut. (One cut equals one track, cover, and if supplied sidelite), 45° miter joining two MUTO systems is two (2) cuts, list \$ x 2				65	

³ Standard or Non-Standard Fabricated; lead time up to 3 days.

⁵ Custom Fabricated items ship in up to 5 business days.

⁶ Special Fabricated/Finish or Special Order; lead time up to 5 weeks.

Wall Mount

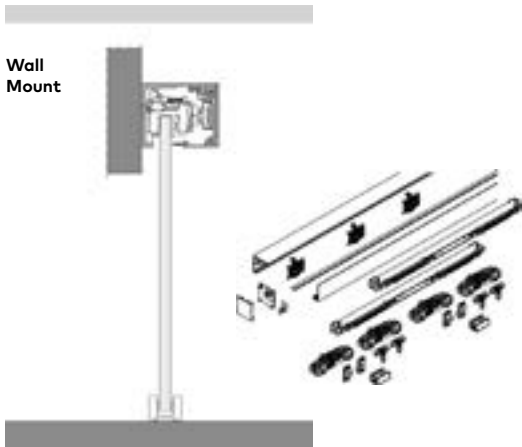

Glass Mount

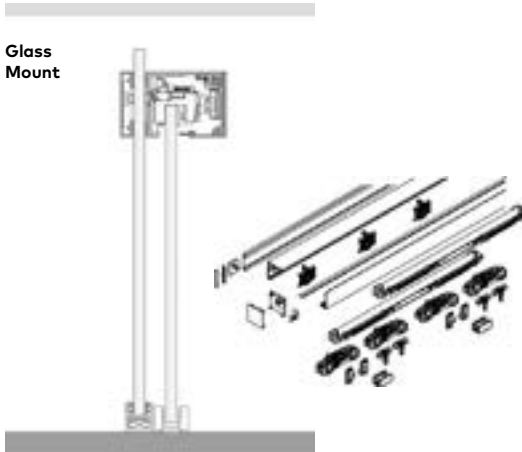

Double Panel Wall Mount (W) Complete Set

- Track Profile (Wall)
- Track Mounting Hardware
- Cover Profile and Clips
- 2 x Set Roller Carriers
- 2 x Unit L 80 DM
- Set Endcaps
- Cover Brush
- Floor Guides

Double Panel Glass (G) Mount Complete Set

- Track Profile (Glass)
- Track Mounting Hardware
- Cover Profile and Clips
- 2 x Set Roller Carriers
- 2 x Unit L 80 DM
- Set Endcaps
- Cover Brush
- Floor Guides
- Glass Mount Profile
- Set Glass Mount Endcaps
- Glass Mount Gasket
- Glass Mount Brackets
- Glass Mount Hardware

Technical Details

- Glass thickness: 5/16"-1/2" (8-13)
- Max door panel weight/double door: 2 x 176 lb (80 kg)
- Max door panel height: 118" (3000)
- Max door panel width: 57" (1448)
- Min door panel width: 39" (990)
- Min clear opening width: 75-13/16" (1926)
- Max clear opening width: 111-7/8" (2842)
- Max track length: 154" (3912)

NOTES

- Maximum door panel sizes cannot all be combined in one application. See disclaimer note on pages 141 & 143.
- For door sizes required to exceed published maximum, contact dormakaba Technical Service at 800-523-8483.
- Pairs of sliders with door panel sizes over 38" (965) require two tracks. Joint will be at the center of clear opening.
- MUTO MTO Complete set prices shown are priced for up to 154" (3912) length.
- Stock 157" (4 m) extrusion lengths include clamp marks on mounting surface within approximately 1/2"-1-3/4" (13-44) from each end which may need to be cut in the field.

MUTO Comfort L 80 DORMOTION (DM)

Two Sliding Panels
– Ceiling, Surface Mount

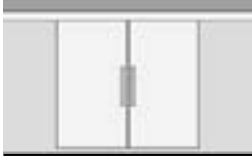
Model	Ref. #	U/M	Description	Standard Finishes \$		Special Finishes \$	
				150	113	Anodized/Powder Paint	
				150	113	199/399	
Two Sliding Panels (2P) with DM Complete				③	⑤	⑤①	
Ceiling (CE-S) Surface Mount							
	MTO	836.330	Set	Ceiling (CE-S) 2 x Panel (2P)	2,077	2,285	2,700
Ref. #	U/M	Accessory Option				List \$	
936.261	Set	Comfort L 80 Wood Door Adaptor Kit (2 m length) (Includes floor guide)				107	
MITER	Ea.	Miter charge list add per cut. (One cut equals one track, cover, and if supplied sidelite), 45° miter joining two MUTO systems is two (2) cuts, list \$ x 2				65	

- ③ Standard or Non-Standard Fabricated; lead time up to 3 days.
- ⑤ Custom Fabricated items ship in up to 5 business days.
- ⑤① Special Fabricated/Finish or Special Order; lead time up to 5 weeks.

Ceiling Surface Mount



Double Panel Ceiling Surface Mount (CE-S) Complete Set

- Track Profile (Ceiling)
- Track Mounting Hardware
- Cover Profile and Clips
- 2 x Set Roller Carriers
- 2 x Unit L 80 DM
- Set Endcaps
- Cover Brush
- Floor Guides

Technical Details

- Glass thickness: 5/16"–1/2" (8–13)
- Max door panel weight/ double door: 2 x 176 lb (80 kg)
- Max door panel height: 118" (3000)
- Max door panel width: 57" (1448)
- Min door panel width: 39" (990)
- Min clear opening width: 75-13/16" (1926)
- Max clear opening width: 111-7/8" (2842)
- Max track length: 154" (3912)

NOTES

- Maximum door panel sizes cannot all be combined in one application. See disclaimer note on pages 141 & 143.
- For door sizes required to exceed published maximum, contact dormakaba Technical Service at 800-523-8483.
- Pairs of sliders with door panel sizes over 37" require two tracks. Joint will be at the center of clear opening.
- MUTO MTO Complete set prices shown are priced for up to 154" (3912) length.
- Stock 157" (4 m) extrusion lengths include clamp marks on mounting surface within approximately 1/2"–1-3/4" (13–44) from each end which may need to be cut in the field.



DRS Rails, Channels & Accessories

Patch Fittings & Designer Pivots

Offset Hung Patch Fittings

Headers & Accessories

Closers & Hardware

Locksets

Pulls & Handles



Sliding Systems

MANET

Panic Hardware

MUTO Comfort L 80

One or Two Sliding Panels with One or Two Fixed Panels (Sidelites)
 – Ceiling, Surface Mount

Model	Ref. #	U/M	Description	Standard Finishes \$		Special Finishes \$	
				150	113	Anodized/Powder Coat	
Fixed Panel (FP) Mount on Ceiling (CE-S) Surface Mount				3	5	50	
Single Sliding Panel (1P) with One Fixed Panel (1FP) Complete							
	MTO	236.388	Set	Ceiling (CE-S) 1 x Panel (1P) 1 x Fixed Panel (1FP)	1,219	1,341	1,584
Single Sliding Panel (1P) with Two Fixed Panels (2FP) Complete							
	MTO	236.390	Set	Ceiling (CE-S) 1 x Panel (1P) 2 x Fixed Panel (2FP)	1,328	1,462	1,727
		236.331	Ft.	Required ADD for units exceeding 154" (3912)	167	181	214
Two Sliding Panels (2P) with Two Fixed Panels (2FP) Complete							
	MTO	236.392	Set	Ceiling (CE-S) 2 x Panel (2P) 2 x Fixed Panel (2FP)	1,951	2,146	2,536
		236.331	Ft.	Required ADD for units exceeding 154" (3912)	167	181	214
Ref. #	U/M	Accessory Option				List \$	
836.357	Set	Comfort L 80 Synchro Acc. Set (Includes Cable, Pulley, Endstops, etc. [Complete])				609	
936.261	Set	Comfort L 80 Wood Door Adaptor Kit (2 m length) (Includes floor guide)				107	
MITER	Ea.	Miter charge list add per cut. (One cut equals one track, cover, and if supplied sidelite), 45° miter joining two MUTO systems is two (2) cuts, list \$ x 2				65	

3 Standard or Non-Standard Fabricated; lead time up to 3 days.
5 Custom Fabricated items ship in up to 5 business days.

50 Special Fabricated/Finish or Special Order; lead time up to 5 weeks.

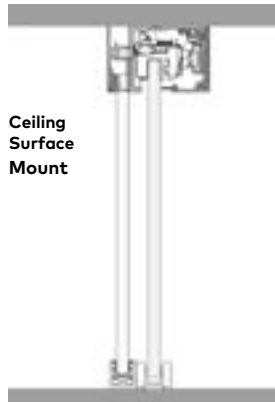

Ceiling Surface Mount

Single Door (1P)
Kit shown

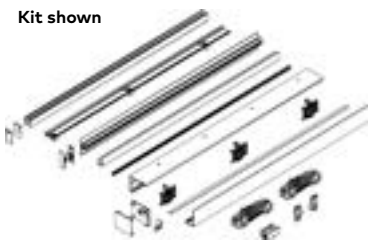

Single Sidelite Ceiling Surface Mount (CE-S) Complete Set

- Track Profile (Ceiling)
- Track Mounting Hardware
- Cover Profile and Clips
- Set Roller Carriers
- Set Endcaps
- Floor Guide
- Cover Brush
- Sidelite Profile and Gasket
- Sidelite Filler Profile
- Set Sidelite Endcaps
- U-Channel (incl Gasket & Endcap)
- Sidelite Extrusion Mounting Hardware

Double Sidelite Ceiling Surface Mount (CE-S) Complete Set

- Track Profile (Ceiling)
- Track Mounting Hardware
- Cover Profile and Clips
- Set Roller Carriers¹
- Set Endcaps
- Cover Brush
- Floor Guide¹
- Sidelite Profile and Gasket
- Sidelite Filler Profile
- Sidelite View Profil
- Set Sidelite Endcaps
- U-Channel (incl Gasket & Endcap)
- Sidelite Extrusion Mounting Hardware

¹Two (2) each for two panels (2P)

Technical Details

- Glass thickness: 5/16"-1/2" (8-13)
- Max door panel weight: 176 lb (80 kg)
- Max door panel height: 118" (3000)
- Max door panel width: 57" (1448)
- Min door panel width: 26" (660)
- Max track length: 154" (3912)
- One Door Panel**
- Min clear opening width: 23-5/8" (600)
- Max clear opening width: 54-5/8" (1388)
- Two Door Panels**
- Min clear opening width: 49-13/16" (1266)
- Max clear opening width: 111-7/8" (2842)

NOTES

- Maximum door panel sizes cannot all be combined in one application. See disclaimer note on pages 141 & 143.
- For door sizes required to exceed published maximum, contact dormakaba Technical Service at 800-523-8483.
- Pairs of sliders with door panel sizes over 38" (965) require two tracks. Joint will be at the center of clear opening.
- MUTO MTO Complete set prices shown are priced for up to 154" (3912) length.
- Stock 157" (4 m) extrusion lengths include clamp marks on mounting surface within approximately 1/2"-1-3/4" (13-44) from each end which may need to be cut in the field.

MUTO Comfort L 80

One Sliding Panel

- Wall and Glass Mounts

Model	Ref. #	U/M	Description	Standard Finishes \$		Special Finishes \$
				150	113	Anodized/Powder Paint
Single Sliding Panel (1P) Complete						(S)

Wall (W) Mount

	MTO	836.320	Set	Wall (W) 1 x Panel (1P)	895 ³	984 ⁵	1,163
---	-----	---------	-----	----------------------------	------------------	------------------	-------

Glass (G) Mount

	MTO	836.322	Set	Glass (G) 1 x Panel (1P)	1,047 ⁵	1,152 ⁵	1,361
---	-----	---------	-----	-----------------------------	--------------------	--------------------	-------

Ref. #	U/M	Accessory Option	List \$
936.261	Set	Comfort L 80 Wood Door Adaptor Kit (2 m length) (Includes floor guide)	107
MITER	Ea.	Miter charge list add per cut. (One cut equals one track, cover, and if supplied sidelite), 45° miter joining two MUTO systems is two (2) cuts, list \$ x 2	65

Wall Mount

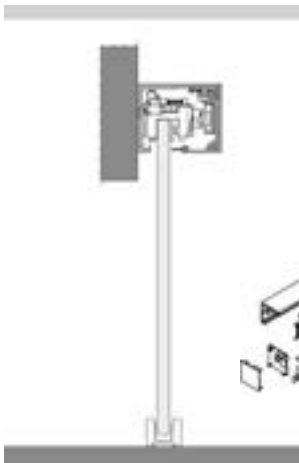

- ³ Standard or Non-Standard Fabricated; lead time up to 3 days.
- ⁵ Custom Fabricated items ship in up to 5 business days.
- ^(S) Special Fabricated/Finish or Special Order; lead time up to 5 weeks.

Single Panel Wall Mount (W) Complete Set

- Track Profile (Wall)
- Track Mounting Hardware
- Cover Profile and Clips
- Set Roller Carriers
- Set Endcaps
- Cover Brush
- Floor Guide

Technical Details

- Glass thickness: 5/16"-1/2" (8-13)
- Max door panel weight: 176 lb (80 kg)
- Max door panel height: 118" (3000)
- Min door panel width: 26" (660)
- Max door panel width: 57" (1448)
- Min clear opening width: 23-5/8" (600)
- Max clear opening width: 54-5/8" (1388)
- Max track length: 154" (3912)

NOTES

- Maximum door panel sizes cannot all be combined in one application. See disclaimer note on pages 141 & 143.
- For door sizes required to exceed published maximum, contact dormakaba Technical Service at 800-523-8483.
- Pairs of sliders with door panel sizes over 38" (965) require two tracks. Joint will be at the center of clear opening.
- MUTO MTO Complete set prices shown are priced for up to 154" (3912) length.
- Stock 157" (4 m) extrusion lengths include clamp marks on mounting surface within approximately 1/2"-1-3/4" (13-44) from each end which may need to be cut in the field.

Single Panel Glass (G) Mount Complete Set

- Track Profile (Glass)
- Track Mounting Hardware
- Cover Profile and Clips
- Set Roller Carriers
- Set Endcaps
- Cover Brush
- Floor Guide
- Glass Mount Profile
- Set Glass Mount Endcaps
- Glass Mount Gasket
- Glass Mount Brackets
- Glass Mount Hardware

Glass Mount



DRS Rails, Channels & Accessories
Patch Fittings & Designer Pivots
Offset Hung Patch Fittings
Headers & Accessories
Closers & Hardware
Locksets
Pulls & Handles
Sliding Systems
MANET
Panic Hardware

MUTO Comfort L 80

One Sliding Panel

– Ceiling, Surface Mount

Model	Ref. #	U/M	Description	Standard Finishes \$		Special Finishes \$
				150	113	Anodized/Powder Paint
Single Sliding Panel (1P) Complete						(SO)
Ceiling (CE-S) Surface Mount						
	236.321	Set	Ceiling (CE-S) 1 x Panel (1P)	895 ③	984 ⑤	1,163
Ref. #	U/M	Accessory Option				List \$
936.261	Set	Comfort L 80 Wood Door Adaptor Kit (2 m length) (Includes floor guide)				107
MITER	Ea.	Miter charge list add per cut. (One cut equals one track, cover, and if supplied sidelite), 45° miter joining two MUTO systems is two (2) cuts, list \$ x 2				65

- ① Non-fabricated item; ships in one business day (24 hours).
- ③ Standard or Non-Standard Fabricated; lead time up to 3 days.
- ⑤ Custom Fabricated items ship in up to 5 business days.
- ⑤① Special Fabricated/Finish or Special Order; lead time up to 5 weeks.

Ceiling Surface Mount



Single Panel Ceiling Surface Mount (CE-S) Complete Set

- Track Profile (Ceiling)
- Track Mounting Hardware
- Cover Profile and Clips
- Set Roller Carriers
- Set Endcaps
- Cover Brush
- Floor Guide

Technical Details

- Glass thickness: 5/16" - 1/2" (8-13)
- Max door panel weight: 176 lb (80 kg)
- Max door panel height: 118" (3000)
- Min door panel width: 26" (660)
- Max door panel width: 57" (1448)
- Min clear opening width: 23-5/8" (600)
- Max clear opening width: 54-5/8" (1388)
- Max track length: 154" (3912)

NOTES



- Maximum door panel sizes cannot all be combined in one application. See disclaimer note on pages 141 & 143.
- For door sizes required to exceed published maximum, contact dormakaba Technical Service at 800-523-8483.
- MUTO MTO Complete set prices shown are priced for up to 154" (3912) length.
- Stock 157" (4 m) extrusion lengths include clamp marks on mounting surface within approximately 1/2" - 1-3/4" (13-44) from each end which may need to be cut in the field.



MUTO Comfort L 80

Two Sliding Panels

– Wall and Glass Mounts

Model	Ref. #	U/M	Description	Standard Finishes \$		Special Finishes \$
				150	113	Anodized/Powder Coat
Two Sliding Panels (2P) Complete						
(SD)						
Wall (W) Mount						
	MTO	836.323	Set	Wall (W) 2 x Panel (2P)	1,700 ^④	1,870 ^④ 2,210
Glass (G) Mount						
	MTO	836.325	Set	Glass (G) 2 x Panel (2P)	1,989 ^⑥	2,187 ^⑥ 2,585
Ref. #	U/M	Accessory Option				List \$
836.357	Set	Comfort L 80 Synchro Acc. Set (Includes Cable, Pulley, Endstops, etc. {Complete})				609
936.261	Set	Comfort L 80 Wood Door Adaptor Kit (2 m length) (Includes floor guide)				107
MITER	Ea.	Miter charge list add per cut. (One cut equals one track, cover, and if supplied sidelite), 45° miter joining two MUTO systems is two (2) cuts, list \$ x 2				65

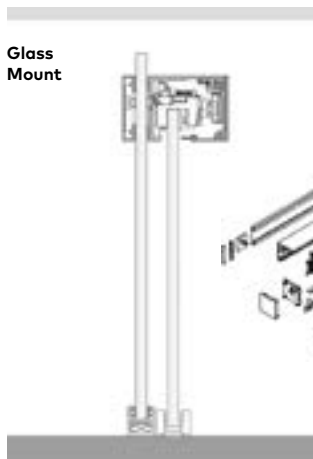
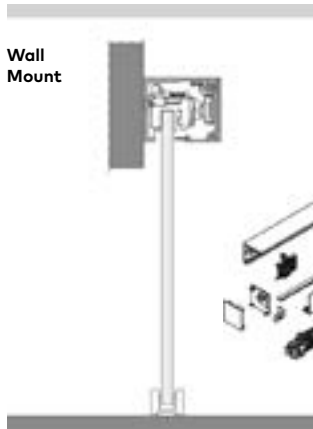

- ④ Standard or Non-Standard Fabricated; lead time up to 3 days.
- ⑤ Custom Fabricated items ship in up to 5 business days.
- ⑥ Special Fabricated/Finish or Special Order; lead time up to 5 weeks.

Double Panel Wall Mount (W) Complete Set

- Track Profile (Wall)
- Track Mounting Hardware
- Cover Profile and Clips
- 2 x Set Roller Carriers
- Set Endcaps
- Cover Brush
- Floor Guides

Double Panel Glass (G) Mount Complete Set

- Track Profile (Glass)
- Cover Profile and Clips
- 2 x Set Roller Carriers
- Set Endcaps
- Cover Brush
- Floor Guides
- Glass Mount Profile
- Set Glass Mount Endcaps
- Glass Mount Gasket
- Glass Mount Brackets
- Glass Mount Hardware

Technical Details

- Glass thickness: 5/16" - 1/2" (8-13)
- Max door panel weight/double door: 2 x 176 lb (80 kg)
- Max door panel height: 118" (3000)
- Min door panel width: 26" (660)
- Max door panel width: 57" (1448)
- Min clear opening width: 49-13/16" (1266)
- Max clear opening width: 111-7/8" (2842)
- Max track length: 154" (3912)

NOTES

- Maximum door panel sizes cannot all be combined in one application. See disclaimer note on pages 141 & 143.
- For door sizes required to exceed published maximum, contact dormakaba Technical Service at 800-523-8483.
- Pairs of sliders with door panel sizes over 38" (965) require two tracks. Joint will be at the center of clear opening.
- MUTO MTO Complete set prices shown are priced for up to 154" (3912) length.
- Stock 157" (4 m) extrusion lengths include clamp marks on mounting surface within approximately 1/2"-1-3/4" (13-44) from each end which may need to be cut in the field.

DRS Rails, Channels & Accessories

Patch Fittings & Designer Pivots

Offset Hung Patch Fittings

Headers & Accessories

Closers & Hardware

Locksets

Pulls & Handles

Sliding Systems

MANET

Panic Hardware

MUTO Comfort L 80

Two Sliding Panels

– Ceiling, Surface Mount

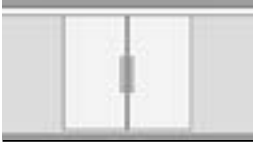
Model	Ref. #	U/M	Description	Standard Finishes \$		Special Finishes \$	
				150	113	Anodized/Powder Paint	
				150	113	199/399	
Two Sliding Panels (2P) Complete				③	⑤	⑤⑩	
Ceiling (CE-S) Surface Mount							
	MTO	836.324	Set	Ceiling (CE-S) 2 x Panel (2P)	1,700	1,870	2,210
Ref. #	U/M	Accessory Option				List \$	
836.357	Set	Comfort L 80 Synchro Acc. Set (Includes Cable, Pulley, Endstops, etc. {Complete})				609	
936.261	Set	Comfort L 80 Wood Door Adaptor Kit (2 m length) (Includes floor guide)				107	
MITER	Ea.	Miter charge list add per cut. (One cut equals one track, cover, and if supplied sidelite), 45° miter joining two MUTO systems is two (2) cuts, list \$ x 2				65	

- ③ Standard or Non-Standard Fabricated; lead time up to 3 days.
- ⑤ Custom Fabricated items ship in up to 5 business days.
- ⑩ Special Fabricated/Finish or Special Order; lead time up to 5 weeks.

Ceiling Surface Mount



Double Panel Ceiling Surface Mount (CE-S) Complete Set

- Track Profile (Ceiling)
- Track Mounting Hardware
- Cover Profile and Clips
- 2 x Set Roller Carriers
- Set Endcaps
- Cover Brush
- Floor Guides

Technical Details



- Glass thickness: 5/16"–1/2" (8–13)
- Max door panel weight/ double door: 2 x 176 lb (80 kg)
- Max door panel height: 118" (3000)
- Min door panel width: 26" (660)
- Max door panel width: 57" (1448)
- Min clear opening width: 49-13/16" (1266)
- Max clear opening width: 111-7/8" (2842)
- Max track length: 154" (3912)

NOTES

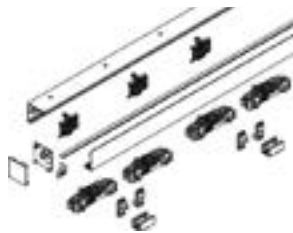
- Maximum door panel sizes cannot all be combined in one application. See disclaimer note on pages 141 & 143.
- For door sizes required to exceed published maximum, contact dormakaba Technical Service at 800-523-8483.
- Pairs of sliders with door panel sizes over 38" (965) require two tracks. Joint will be at the center of clear opening.
- MUTO MTO Complete set prices shown are priced for up to 154" (3912) length.
- Stock 157" (4 m) extrusion lengths include clamp marks on mounting surface within approximately 1/2"–1-3/4" (13–44) from each end which may need to be cut in the field.

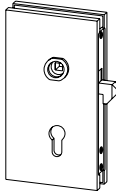
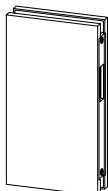
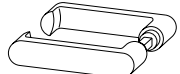
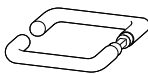

Locksets, Strikes, and Handles

Model	Ref. #	U/M	Finishes \$		
			101	105	108/109
Hook Lock					
	905.202	Ea. (Includes wall mounted strike plate)	396 ^{8W}	515 ^{8W}	661 ^{8W}
Strike Box					
	905.201	Ea.	396	469	661
Set of Flat Lever Handles					
	910.314	Set	62 ⁵	80 ^{8W}	113 ^{8W}
Set of Tubular Lever Handles					
	910.301	Set	137	154	198
Flush Pull					
	907.200	Set	134 ¹	201 ¹	201 ^{8W}





- ⁵ Custom Fabricated; lead time up to 5 business days.
- ¹ Non-Fabricated item, ships in 1 business day.
- ^{8W} Special Order; custom product globally sourced from dormakaba factory.

NOTES:

- Cylinders supplied keyed different (KD). For other cylinder and keying options such as keyed alike (KA) See **Cylinder Types, Keying Options, and Keyways**, page 115.
- For 108 or 109 finish requirements, specify 199 finish and specify "to be finished black or dark bronze."

DRS Rails, Channels & Accessories
Patch Fittings & Designer Pivots
Offset Hung Patch Fittings
Headers & Accessories
Closers & Hardware
Locksets
Pulls & Handles
Sliding Systems
MANET
Panic Hardware

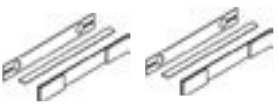
MUTO Accessories & Components

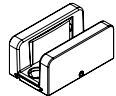









Model	Ref. #	U/M	Description	Standard ^{1,2}	Special Finishes \$	
				Finish \$	Powder Coat	
				150	399	711
Roller Accessory Kit, Complete						
	836.550	Set	Premium XL 150/120 roller carrier kit (Use with or without DM, Synchro or Self-Closing) Consists of 2 roller carriers, 2 endstops, 1 floor guide and 2 hooks	621	684	684
	836.349	Set	Comfort L 80 roller carrier kit (Use with or without DM or Synchro) Consists of 2 roller carriers, 2 endstops, 1 floor	509	561	
Gasket Sets				List \$		
	836.451	Set	Two (2) Premium XL 150/120 DM/Synchro/Self-Closing Gasket Sets		31	
	836.251	Set	Two (2) Comfort L 80 DM/Synchro Gasket Sets		30	
Floor Guide				150	399	693
	807.316	Ea.	MUTO Glass Door Floor Guide, adjustable 5/16"–17/32" (8-13.5) (Used for all finishes for MUTO).	70	133	133

NOTES

1 in the Roller Accessory Kits, the finish designation only applies to the Floor Guide.







2 Floor Guide for 113 finish will be supplied as 150.

MUTO Accessories & Components

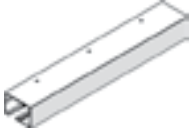
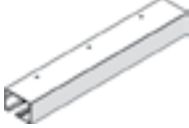





Model	Ref. #	U/M	Description	Standard Finishes \$		Special Finishes \$ Anodized/Powder Coat	
				150	113	199/399	711
Track and Cover Extrusions				3	5	50	50
	936.552	Ln.	Premium XL 150 Wall Mount Track (Used with or without DM) Fixed ~13' (4 m) length	779	857	1,052	1,052
	836.553	Ft.	Order by length in feet	62	68	83	83
	936.850	Ln.	Premium XL 120 Self-Closing Wall Mount Track Fixed ~13' (4 m) length	1,012	1,114	1,366	—
	836.651	Ft.	Order by length in feet	80	89	108	—
	936.350	Ln.	Comfort L 80 Wall Mount Track (Used with or without DM) Fixed ~13' (4 m) length	546	601	737	—
	836.351	Ft.	Order by length in feet	43	47	58	—
	936.554	Ln.	Premium XL 150 Ceiling Mount Track (Used with or without DM) for DM Ceiling Install Fixed ~13' (4 m) length	779	857	1,052	1,052
	836.555	Ft.	Order by length in feet	62	68	83	83
	936.852	Ln.	Premium XL 120 Self-Closing Ceiling Mount Track Fixed ~13' (4 m) length	1,012	1,114	1,366	—
	836.653	Ft.	Order by length in feet	80	89	108	—
	936.352	Ln.	Comfort L 80 Ceiling Mount Track (Used with or without DM) Fixed ~13' (4 m) length	546	601	737	—
	836.353	Ft.	Order by length in feet	43	47	58	—
	936.562	Ln.	Premium XL 150 Fixed Panel (Sidelite) Track (DM and non-DM) Fixed ~13' (4 m) length	570	627	770	770
	936.563	Ft.	Order by length in feet	45	49	60	60
	936.856	Ln.	Premium XL 120 SC Fixed Panel (Sidelite) Track Fixed ~13' (4 m) length	570	627	770	—
	936.857	Ft.	Order by length in feet	45	49	60	—
	936.361	Ln.	Comfort L 80 Fixed Panel (Sidelite) Track Fixed ~13' (4 m) length	560	615	756	—
	936.362	Ft.	Order by length in feet	44	48	59	—
	936.566	Ln.	Premium XL 150 Track Front Cover Profile Kit (shown highlighted in grey) (Used with and without DM, includes cover and 13 ea. cover clips) Fixed ~13' (4 m) length	302	332	408	408
	836.567	Ft.	Order by length in feet, 1 cover clip per ft +1	24	26	32	32

- DRS Rails, Channels & Accessories
- Patch Fittings & Designer Pivots
- Offset Hung Patch Fittings
- Headers & Accessories
- Closers & Hardware
- Locksets
- Pulls & Handles
- Sliding Systems
- MANET
- Panic Hardware

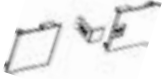
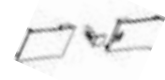
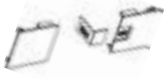
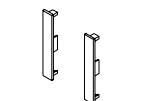
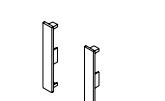
MUTO Accessories & Components

Model	Ref. #	U/M	Description	Standard Finishes \$		Special Finishes \$ Anodized/Powder Coat	
				150	113	199/399	711
	936.854	Ln.	Premium XL 120 Self-Closing Track Front Cover Profile Kit (shown highlighted in grey) (Includes cover and 13 ea. cover clips) Fixed ~13' (4 m) length	393	432	530	—
	836.655	Ft.	Order by length in feet, 1 cover clip per ft +1	31	34	42	—
	936.656	Ln.	Premium XL120 Self-Closing Track Front Cover Profile Kit (shown highlighted in grey) (CE-R) (Includes cover and 13 ea. cover clips) Fixed ~13' (4 m) length	393	432	530	—
	936.657	Ft.	Order by length in feet, 1 cover clip per ft +1	31	34	42	—
	936.359	Ln.	Comfort L 80 Track Front Cover Profile Kit (shown highlighted in grey) (Used with and without DM, includes cover and 13 ea. cover clips) Fixed ~13' (4 m) length	212	233	287	—
	836.360	Ft.	Order by length in feet, 1 cover clip per ft +1	17	19	23	—
Model	Ref. #	U/M	Description	List \$			
Wood Adapter Sets							
	936.995	Pk	#12 fasteners and anchors (5 ea.) for mounting MUTO track profile				11
	936.463	Ln.	Premium XL 150/120 Wood Door Adaptor Kit, includes floor guide(s) Length 4 m (4 guides)				212
	936.461	2m					120
	936.464	Ft.					19
	936.262	Ln.	Comfort L 80 Wood Door Adaptor Kit, includes floor guide(s) Length 4 m (4 guides)				190
	936.261	2m					107
	936.263	Ft.					18
	836.148	Ea.	Floor Guide				3
Cover Clips							
	836.147	Ea.	Cover clip for Premium XL systems				5
	836.146	Ea.	Cover clip for Comfort L systems				5

MUTO Accessories & Components

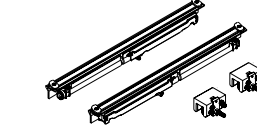
Model	Ref. #	U/M	Description	Standard Finishes \$		Special Finishes \$ Powder Coat	
				150/113	399	693	
Endcaps							
	836.556	Set	Premium XL 150 Endcap Set (With or without DM, LH and RH for Wall/ Ceiling Mount)	27	36	36	
	836.656	Set	Premium XL Self-Closing Endcap Set (LH and RH for Wall/Ceiling Mount)	27	36	—	
	836.354	Set	Comfort L 80 Endcap Set (With or without DM, LH and RH for Wall/Ceiling Mount)	26	36	—	
	836.460	Set	Premium XL 150/120 SC/80 Endcap Set (With or without DM, LH and RH for Glass Mount)	27	36	36	
	836.260	Set	Comfort L 80 Endcap Set (With or without DM, LH and RH for Glass Mount)	26	36	—	
Model	Ref. #	U/M	Description	List \$			
DORMOTION Accessory and Start/Stop Kits							
	836.558	Set	Premium XL 150 DM Acc. Set (Includes DORMOTION Cushion and 2 DM start/stops)	574			
	836.660 836.661	Set RH Set LH	Premium XL 120 DM Self-Closing Acc. Set (Includes DORMOTION Cushion and 1 DM start/stop)	463			
	836.666	Set	Premium XL 120 SC DMSC Acc (Includes DORMOTION Cushion and 1 DM start/stop)	342			
	836.557	Set	Premium XL 80 DM Acc. Set (Includes DORMOTION Cushion and 2 DM start/stops) Allows XL 150 sliders to be installed to minimum door panels of 31-7/8" (810)	463			
	836.786	Set	Premium XL 80 TEL DM Acc. Set (Includes DORMOTION Cushion and 2 DM start/stops)	501			
	836.361	Set	Comfort L 80 DM Acc. Set (26" [660] min. panel width) (Includes DORMOTION Cushion and 2 DM start/stops)	265			

DRS Rails, Channels & Accessories

Patch Fittings & Designer Pivots

Offset Hung Patch Fittings

Headers & Accessories

Closers & Hardware

Locksets











Pulls & Handles

Sliding Systems



MANET

Panic Hardware

MUTO Accessories & Components

Model	Ref. #	U/M	Description	List \$
	836.559	Set	Premium XL 150/80 DM Start/Stop Set (Includes 2 DM start/stops)	85
	836.356	Set	Comfort L 80 DM Start/Stop Set (Includes 2 DM start/stops)	79
	836.662	Ea.	Premium XL 120 DM Start/Stop Set (Includes 2 DM start/stops)	93
Synchro Accessories				
	836.560	Set	Premium XL 150 Synchro Acc. Set (Includes Cable, Pulley, Endstops, etc. {Complete}) [Not compatible with DM]	731
	836.357	Set	Comfort L 80 Synchro Acc. Set (Includes Cable, Pulley, Endstops, etc. {Complete}) [Not compatible with DM]	609
	836.358	Ea.	Premium XL 150 Synchro Cable [Not compatible with DM] Long lead-time	138
	836.782	Ea.	Premium XL 80 TEL Service Cable [Not compatible with Synchro Cable] Handing is field reversible (Extended lead-time item)	138
Self-Closing Accessories				
	836.657 836.658	Set RH Set LH	Premium Flexi-Cable Service Unit, Self-Closing (Complete Housing w/Pulleys and Accessories) (Specify RH / LH)	830
	836.659	Ea.	Premium Flexi-Cable for Service, Self-Closing (Cable Only) Long lead-time	277
Brush Profiles				
	836.912.807	Ft.	Premium/Comfort Brush Profile XL 150/120 or L 80 for 5/16" – 3/8" (8 – 10) glass (shown highlighted in grey)	2
	836.912.803	Ft.	Premium/Comfort Brush Profile XL 150/120 or L 80 for 5/16" – 3/8" (8 – 10) glass, Option Black	3
	836.913.807	Ft.	Premium/Comfort Brush Profile XL 150/120 or L 80 for 1/2" – 17/32" (12 – 13.5) glass (shown highlighted in grey)	2
	836.913.803	Ft.	Premium/Comfort Brush Profile XL 150/120 or L 80 for 1/2" – 17/32" (12 – 13.5) glass, Option Black	3

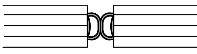
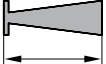
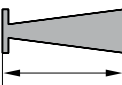
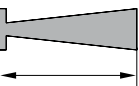
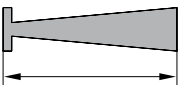
MUTO Accessories & Components

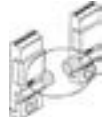
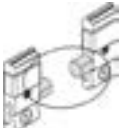
Model	Ref. #	U/M	Description	Standard Finishes \$		Special Finishes \$ Anodized/ Powder Coat	List \$
				150	113	199/399	
Brush Seal Carrier							
	836.826	Ln.	MUTO Premium/Comfort carrier profile, for vertical brush seal, stock length is 177-1/8" (4.5 m) (Aluminum color)	168	168	—	
Brush Seals for XL 80 TEL (Telescopic)							
	815.509	Ft.	MUTO Premium/Comfort vertical bulb/tubular seal for leading edge of glass to jamb/glass to glass, specify length by feet (2x required for pairs) (Clear-frost)				1
	836.860	Ft.	MUTO Premium/Comfort vertical brush seal for gaps 1/2"-5/8" (13-16), specify length by feet (Grey)				1
	836.861	Ft.	MUTO Premium/Comfort vertical brush sealing for gaps >5/8"-3/4" (>16-19), specify length by feet (Grey)				1
	836.862	Ft.	MUTO Premium/Comfort vertical brush sealing for gaps >3/4"-29/32" (>19-23), specify length by feet (Grey)				1
	836.863	Ft.	MUTO Premium/Comfort vertical brush sealing for gaps >29/32"-1-1/16" (>23-27), specify length by feet (Grey)				1
Endstops							
	836.465	Set	Premium XL 150 Endstop Set (2 ea.)				89
	836.267	Set	Comfort L 80 Endstop Set (2 ea.)				79
Bumper Sets							
	836.466	Set	Premium XL 150 Bumper Set (2 ea.) (shown highlighted in grey) (Used in Endstop; Bumpers only)				15
	836.268	Set	Comfort L 80 Bumper Set (2 ea.) (shown highlighted in grey) (Used in Endstop; Bumpers only)				14

DRS Rails, Channels & Accessories

Patch Fittings & Designer Pivots

Offset Hung Patch Fittings

Headers & Accessories

Closers & Hardware

Locksets

Pulls & Handles

Sliding Systems

MANET

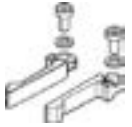

Panic Hardware

MUTO Accessories & Components

Model	Ref. #	U/M	Description	List \$
Holder Hook Sets				
	836.467	Set	Premium XL 150 Carrier Holder Hook Set (2 ea.) (Connects to Carrier, Latches on Endstop)	25
	836.269	Set	Comfort L 80 Carrier Holder Hook Set (2 ea.) (Connects to Carrier, Latches on Endstop)	22

Model	Ref. #	U/M	Description	Standard Finishes \$		Special Finishes \$ Anodized/Powder Coat	
				150	113	199/399	711







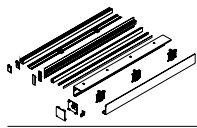
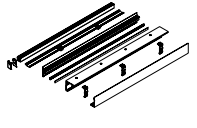
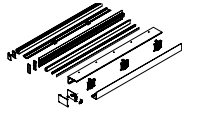
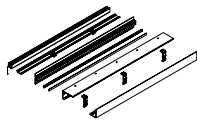
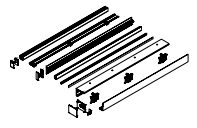

Sidelite (Fixed Panel) Extrusions and Accessories

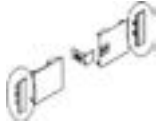
	936.469	Ln.	Premium XL 150/Synchro Sidelite Profile (shown highlighted in grey) (Connects to glass at top) 2-23/32" (69) height complete w/ gaskets (3/8" - 1/2" [10 - 13] thick glass; see below for gasket for other thicknesses) Fixed ~13' (4 m) length (includes fasteners)	422	459	554	554
	836.474	Ft.	Order by length in feet (includes fasteners)	33	36	44	44
	936.272	Ln.	Comfort L 80/Synchro Sidelite Profile (shown highlighted in grey) (Connects to glass at top) 2-9/32" (58) height complete w/gaskets (3/8" - 1/2" [10 - 13] thick glass; see below for gasket for other thicknesses) Fixed ~13' (4 m) length (includes fasteners)	307	333	407	407
	836.274	Ft.	Order by length in feet (includes fasteners)	24	26	32	32

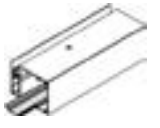
Fixed Panel Sidelite Kits (includes Track/COV/U-Channel/Sidelite Profile, E-Caps, Fasteners)

	236.530	Ln.	XL 150 DM/XL 150 Premium Sidelite Kit Max 157" (4 m)	1,832	2,020	2,401	2,401
	236.531	Ft.	Order by length in feet	185	200	239	239
	236.532	Ln.	XL 150 DM/XL 150 Premium Sidelite Kit (CE-R). Max 157" (4 m)	1,832	2,020	2,401	2,401
	236.533	Ft.	Order by length in feet	185	200	239	239
	236.630	Ln.	XL 120 SC Premium Sidelite Kit Max 157" (4 m)	1,923	2,121	2,523	-
	236.631	Ft.	Order by length in feet	193	209	248	-
	236.632	Ln.	XL 120 SC Premium Sidelite Kit (CE-R) Max 157" (4 m)	1,923	2,121	2,523	-
	236.633	Ft.	Order by length in feet	193	209	248	-
	236.330	Ln.	L 80 DM/L 80 Comfort Sidelite Kit Max 157" (4 m)	1,607	1,772	2,098	-
	236.331	Ft.	Order by length in feet	167	181	214	-

MUTO Accessories & Components

Model	Ref. #	U/M	Description	Standard Finishes \$		Special Finishes \$ Anodized/Powder Coat	
				150	113	199/399	693
	836.471	Set	Premium XL 150/120 SC/80 Sidelite Endcap Set (shown highlighted in grey) (With or without DM, LH and RH for Sidelite Mount) Acc. Set. 2-9/32" (58) height	27	27	36 (399 only)	36
	836.273	Set	Comfort L 80 Sidelite Endcap Set (shown highlighted in grey) (With or without DM, LH and RH for Sidelite Mount) Acc. Set. 2-9/32" (58) height	26	26	36 (399 only)	—
Sidelite Profile Accessories				150	113	109/199/399	
	936.800	Ln.	Premium/Comfort View Profile for use w/ Sidelite (shown highlighted in grey) 2-9/32" (58) and 2-23/32" (69) height; includes 13 ea. clips Fixed ~13' (4 m) length	279	307	377	
	836.801	Ft.	Order by length in feet, 1 clip per ft	22	25	28	
	936.802	Ln.	Premium/Comfort Filler Profile for use w/Sidelite Profile (shown highlighted in grey) 2-9/32" (58) and 2-23/32" (69) height Fixed ~13' (4 m) length	161	177	217	
	836.803	Ft.	Order by length in feet	13	14	17	
	836.891	Ea.	View profile clips, use with view profile extrusion for Sidelite application				<u>List \$</u> 4
				150	113	199/399	
	836.821	Ln.	Premium XL 150/120 Drop Ceiling Connector Profile (Incl. extrusion and fasteners) Fixed ~19'6" (6 m) length	449	488	644	
	836.820	Ft.	Order by length in feet	23	25	33	
Dri-Fit® Channel for 3/8" and 1/2" Glass with mounting holes pre-drilled				150	113	109	199/399
	925.447	Ft.	1" x 1" Dri-Fit Anodized (Gasket included)	14	18	16	30
Dri-Fit® Channel Endcaps (Snap Fit)				803 (Black)	807 (Grey)		
	925.121	Set	U-Channel Endcaps set for Ref. # 925.447.	5 ①	5 ①		

DRS Rails, Channels & Accessories

Patch Fittings & Designer Pivots

Offset Hung Patch Fittings

Headers & Accessories

Closers & Hardware

Locksets





Pulls & Handles

Sliding Systems

MANET

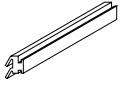



Panic Hardware

MUTO Accessories & Components

Dri-Fit® Channel and Sidelite Gasket				List \$
	925.147	Ea.	Gasket for 1" x 1" Dri-fit® U-Channel, 1/2" (12) thick glass (Clear)	1
	925.148	Ea.	Gasket for 1" x 1" Dri-fit® U-Channel, 3/8" (10) thick glass (Clear)	1
	836.195	Ft.	Service part, sidelite profile gasket 5/16"-3/8" (8-10) thick glass (Black)	3
	836.196	Ft.	Service part, sidelite profile gasket 3/8"-1/2" (10-13) thick glass (Black)	3
	836.197	Ft.	Service part, sidelite profile gasket 1/2"-17/32" (13-13.5) thick glass (Black)	3

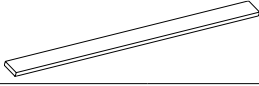
Model	Ref. #	U/M	Description	List \$
-------	--------	-----	-------------	---------

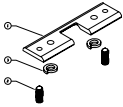
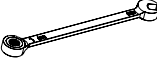
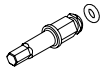



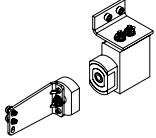
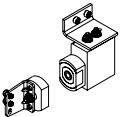
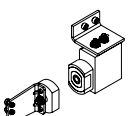

Recessed Mount Accessories

	933.915	Rl.	Foam, Adhesive Back 3/16" Vinyl (Supplied optional for CE-R units, 50Ft. Roll) (Grey)	39
	936.145	Ea.	XL Premium Recessed Cover Clip	6
	936.561	Ea.	XL Premium Recessed Start/Stop Service Plate	13
	936.897	Ea.	Wrench, 6MM Ratcheting / Combo (Use w/PN# 936.898 and 936.899 hex bit in CE-R units)	21
	936.898	Ea.	M4 Long Hex Bit, Recessed Mount Service Item	16
	936.899	Ea.	M4 Short Hex Bit, Recessed Mount Service Item	16

E-Lock

	936.141	Ea.	Premium XL 150 DM electromagnetic lock kit, 12-24 VDC (12V/0.28A, 24V/0.14A), conceals in track & jamb	475
	936.142	Ea.	Premium XL 150 electromagnetic lock kit, 12-24 VDC (12V/0.28A, 24V/0.14A), conceals in track & jamb	475
	936.143	Ea.	Premium XL 120 SC electromagnetic lock kit, 12-24 VDC (12V/0.28A, 24V/0.14A), conceals in track & jamb	475

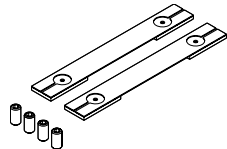
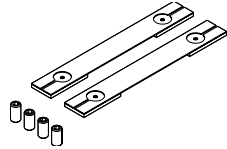
MUTO Accessories & Components

Model	Ref. #	U/M	Description	List \$
Status Indicator				
	836.840	Set	Premium Status Indicator Acc. Set (Package Complete, includes Sensor, Cables, etc.)	593
Fastener Packs				
	807.585	Pk.	M6x14 for mounting sidelite profile or drop ceiling profile	10
	836.585	Pk.	M6x35 for mounting drop ceiling profile	10
Tempered Laminated Glass (TLG) Accessories				
 LGAA	934.801	Ea.	3M™ Scotch-Weld™ EPX™ plus II applicator with 2:1 and 1:1 plunger	330
 LGA	934.800	Ea.	3M™ Scotch-Weld™ Urethane Adhesive, DP 605 NS, off white, 1 tube per 4 roller carriers	78
 MTIPS	934.805	Set	3M™ Scotch-Weld™ EPX™ plus II mixing square nozzle, 5.3 (4 tips per set)	10
	836.468	Set	Premium XL 150/120 TLG Gasket Set (Can be used w/roller sets 836.550) Glue & tips sold separately	31
	836.270	Set	Comfort L 80 TLG Gasket Set (Can be used w/roller set 836.349) Glue & tips sold separately	30
Carrier Locating Tool				
	936.999	Ea.	Premium/Comfort Carrier Locating Tool Accessory tool for quickly and easily locating roller carrier on top of moving panel	6
MUTO Tool Kit				
	936.996	Ea.	MUTO Tool Kit Accessory tool kit, incl. typical tools used for installation and adjustment of MUTO Comfort systems	214

DRS Rails, Channels & Accessories

Patch Fittings & Designer Pivots

Offset Hung Patch Fittings

Headers & Accessories

Closers & Hardware

Locksets

Pulls & Handles

Sliding Systems

MANET

Panic Hardware

DRS-120 and RS-120

Ordering Guide

Panel Type				RS120 Options		Clear Opening Width		
FPONLY	— Fixed Panel Only			807150	— RS 120 Syncro	Sliding Panel 1¹	Sliding Panel 2¹	
2SP_2FP	— 2 Sliding, 2 Fixed Panels			807330	— RS 120 Wood	SPECIFY	SPECIFY	
2SP	— 2 Sliding Panels			NONE	— None			
1SP_1FP	— 1 Sliding, 1 Fixed Panel							
1SP	— 1 Sliding Panel							
DRS120	1SP	CEILING	NONE	STD				continued below
DRS120 — DRS 120 Slider		WALL		STD — Standard 1-3/16" Overlap				
RS120 — RS 120 Slider		CEILING		SPECIFY — Nonstandard Overlap, Specify				
Model		Mount Type		Overlap				

Width		DRS Rail Height		Other DRS Rail Height²		Lock	
Fixed Panel 1¹	Fixed Panel 2¹	358 — 3-5/8"	4 — 4"	358	4	BRASSLCK — Brass Lock 1-9/16" w/ 5/8" Throw	NONE — None
SPECIFY	SPECIFY	6 — 6"	10 — 10"	6	10		
		12MM	358	SQ	358	SQ	113
		10MM — 3/8" (10)		TP — Tapered		TP	NONE
		12MM — 1/2" (12)		SQ — Square		SQ	
		Glass Thickness		DRS Rail Profile		Other DRS Rail Profile²	
						101 — Clear Anodized (CL)	
						107 — Similar to Stainless Steel (SSS)	
						108 — Dark Bronze (DB)	
						109 — Black Anodized (BK)	
						114 — Aluminum (EV-1)	
						503 — Polished Brass w/o Lacquer (PB)	
						599 — Satin Brass w/o Lacquer (SB)	
						600 — Satin Bronze w/o Lacquer (SBZ)	
						601 — Polished Bronzed w/o Lacquer (PB2)	
						700 — Satin Stainless Steel (SS/US32D)	
						701 — Polished Stainless Steel (PS/US32)	
						999 — Custom Powder	
						Slider Finish	

¹ Specify width in inches.

² Specify other DRS Rail Height or Other DRS Rail Profile if different from first set of rails.

DRS-120 Sliding System, Ceiling Mount

3/8" (10) and 1/2" (12) Glass Door Thickness

Model	Ref. #	U/M Description	Standard Finishes \$					Custom Powder \$
			101	108/109	503/599	600/601	700/701	999
Single Sliding Panel, Complete			3	3	(SO)	(SO)	3	(SO)
Square								
	207.051	Ea. Panel Width 20" to 35"	1,058	1,085	1,582	1,731	1,389	1,285
	207.052	Ea. Panel Width 36" to 47"	1,134	1,167	1,805	1,999	1,548	1,436
	207.053	Ea. Panel Width 48" to 59"	1,209	1,255	2,027	2,267	1,706	1,587
	207.054	Ea. Panel Width 60" to 72"	1,288	1,340	2,251	2,535	1,863	1,742
Tapered								
	207.067	Ea. Panel Width 20" to 35"	1,064	1,099	1,582	1,734	1,390	1,291
	207.068	Ea. Panel Width 36" to 47"	1,139	1,189	1,805	2,002	1,548	1,442
	207.069	Ea. Panel Width 48" to 59"	1,216	1,273	2,027	2,269	1,706	1,594
	207.070	Ea. Panel Width 60" to 72"	1,293	1,363	2,251	2,538	1,863	1,746

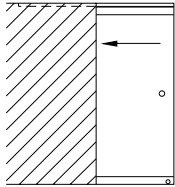

*See below for metric widths

NOTE:

For track lengths exceeding 2 times the panel width, a list charge of \$245/ft. will be applied.

Includes the following items

- Track (2 x panel width)
- Top 3-5/8" (92) DRS rail with rollers
- Brackets
- Panel guides and panel stops
- Bottom 3-5/8" (92) DRS rail with lock
- Cylinder, thumbturn, and dust-proof strike
- Concealed floor guide
- Handle not included, optional

Calculations for ceiling mount with 1 overlapping edge

- Sliding Panel Width = Clear opening* + 1-3/8" (35)
- Track Length = (Clear opening* + 1-3/8" (35)) x 2

* Allow for handle or lock projection when calculating.
 DRS lock projection allowance should be > 3" (76).
 (Clear opening + 1-3/8" [35] + panel projection allowance for handle/lock)

- 3 Standard or Non-Standard Fabricated; lead time up to 3 business days.
- (SO) Special Fabricated/Finish or Special Order; lead time up to 5 weeks.

NOTES:

- When ordering, please specify glass thickness and sliding panel width.
- Maximum weight of sliding panel = 264 lb (120 kg).
- Track will be spliced when length exceeds 157" (4 m).
- Track only available mill finish, to be recessed when installed.

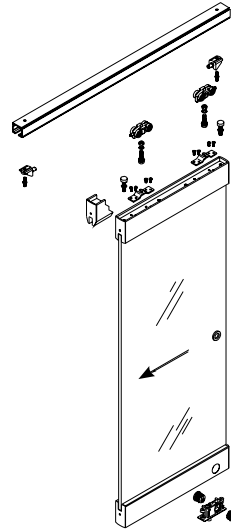

* Equivalent metric widths:
 20" to 35" = 508 to 889
 36" to 47" = 914 to 1,194
 48" to 59" = 1,219 to 1,499
 60" to 72" = 1,524 to 1,829

DRS Rails, Channels & Accessories
 Patch Fittings & Designer Pivots
 Offset Hung Patch Fittings
 Headers & Accessories
 Closers & Hardware
 Locksets
 Pulls & Handles
 Sliding Systems
 MANET
 Panic Hardware

DRS-120 Sliding System, Ceiling Mount

Single Sliding Panel with One Fixed Panel

Model	Ref. #	U/M Description	Standard Finishes \$					Custom Powder \$
			101	108/109	503/599	600/601	700/701	999
Single Sliding Panel with Fixed Panel, Complete			3	3	(SO)	(SO)	3	(SO)
Square								
	207.059	Ea. Panel Width 20" to 35"	1,527	1,596	2,487	2,798	2,100	1,981
	207.060	Ea. Panel Width 36" to 47"	1,616	1,709	2,922	3,316	2,406	2,220
	207.061	Ea. Panel Width 48" to 59"	1,759	1,874	3,350	3,832	2,703	2,515
	207.062	Ea. Panel Width 60" to 72"	1,903	2,041	3,778	4,349	3,002	2,810
Tapered								
	207.075	Ea. Panel Width 20" to 35"	1,534	1,614	2,487	2,633	2,100	1,987
	207.076	Ea. Panel Width 36" to 47"	1,625	1,732	2,922	3,279	2,406	2,230
	207.077	Ea. Panel Width 48" to 59"	1,768	1,749	3,350	3,796	2,703	2,524
	207.078	Ea. Panel Width 60" to 72"	1,912	2,073	3,778	4,314	3,002	2,819

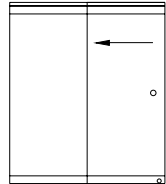

***See below for metric widths**

NOTE:
For track lengths exceeding 2 times the panel width, a list charge of \$245/ft. will be applied.

Includes the following items

- Track (equal to 2 x panel width)
- Top 3-5/8" (92) DRS rail with rollers Brackets
- Panel guides and panel stops
- Bottom 3-5/8" (92) DRS rail with lock
- Cylinder, thumbturn, and dust-proof strike
- Concealed floor guide
- Top and bottom 3-5/8" (92) DRS Dri-Fit Sidelites, including angle brackets to attach Dri-Fit Sidelites to track
- Handle not included, optional

Calculations for ceiling mount with 1 overlapping edge

- Sliding Panel Width = Clear opening* + 1-3/8" (35)
- Track Length = Overall opening width
- Fixed Panel Width = Overall opening width – clear opening* width

* Allow for handle or lock projection when calculating.
DRS lock projection allowance should be > 3" (76).
(Clear opening + 1-3/8" [35] + panel projection allowance for handle/lock)

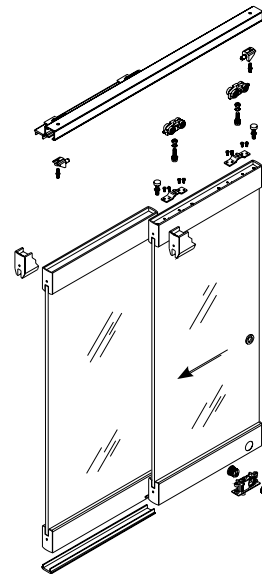

* Equivalent metric widths:
20" to 35" = 508 to 889
36" to 47" = 914 to 1,194
48" to 59" = 1,219 to 1,499
60" to 72" = 1,524 to 1,829

- 3** Standard or Non-Standard Fabricated; lead time up to 3 business days.
- (SO)** Special Fabricated/Finish or Special Order; lead time up to 5 weeks.

- NOTES:**
- When ordering, please specify glass thickness, sliding panel width, and fixed panel width.
 - Maximum weight of sliding panel = 264 lb (120 kg).
 - Track will be spliced when length exceeds 157" (4 m).
 - Track only available mill finish, to be recessed when installed.

DRS-120 Sliding System, Ceiling Mount

Two Sliding Panels

Model	Ref. #	U/M	Description	Standard Finishes \$					Custom Powder \$
				101	108/109	503/599	600/601	700/701	999
Two Sliding Panels, Complete				3	3	(SO)	(SO)	3	(SO)
Square									
	207.055	Ea.	Panel Width 20" to 35"	2,117	2,169	3,096	3,471	2,778	2,570
	207.056	Ea.	Panel Width 36" to 47"	2,270	2,339	3,610	4,006	3,094	2,875
	207.057	Ea.	Panel Width 48" to 59"	2,422	2,508	4,055	4,541	3,411	3,178
	207.058	Ea.	Panel Width 60" to 72"	2,576	2,678	4,501	5,077	3,728	3,484
Tapered									
	207.071	Ea.	Panel Width 20" to 35"	2,127	2,201	3,164	3,471	2,778	2,580
	207.072	Ea.	Panel Width 36" to 47"	2,280	2,379	3,610	4,006	3,094	2,885
	207.073	Ea.	Panel Width 48" to 59"	2,433	2,547	4,055	4,541	3,411	3,189
	207.074	Ea.	Panel Width 60" to 72"	2,584	2,724	4,501	5,077	3,728	3,492

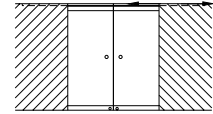

*See below for metric widths

NOTE:

For track lengths exceeding 2 times the panel width, a list charge of \$245/ft. will be applied.

Includes the following items

- Two tracks (each 2 x single panel width)
- Two top 3-5/8" (92) DRS rails with rollers
- Brackets
- Panel guides and panel stops
- Two bottom 3-5/8" (92) DRS rails with lock
- Cylinder, thumbturn, and dust-proof strike
- Concealed floor guides
- Handles not included, optional

Calculations for ceiling mount with 2 overlapping edges

- Sliding Panel Widths = (Clear opening* + 2-3/4" (70)) / 2
- Track Length = (Clear opening* + 2-3/4" (70)) x 2

* Allow for handle or lock projection when calculating.
 DRS lock projection allowance should be > 3" (76).
 (Clear opening + 1-3/8" [35] + panel projection allowance for handle/lock)

- 3** Standard or Non-Standard Fabricated; lead time up to 3 business days.
- (SO)** Special Fabricated/Finish or Special Order; lead time up to 5 weeks.

NOTES:

- When ordering, please specify glass thickness and panel width.
- Maximum weight of sliding panel = 264 lb (120 kg).
- Track will be spliced when length exceeds 157" (4 m).
- Track available in mill finish only, to be recessed when installed.

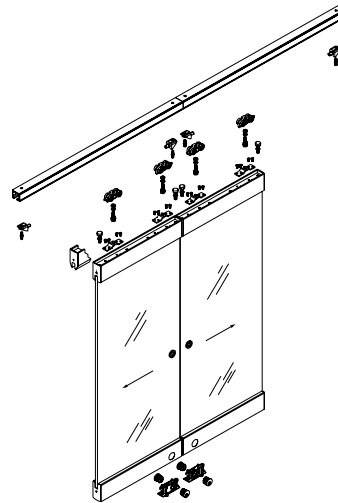

† Equivalent metric widths:
 20" to 35" = 508 to 889
 36" to 47" = 914 to 1,194
 48" to 59" = 1,219 to 1,499
 60" to 72" = 1,524 to 1,829

DRS Rails, Channels & Accessories
 Patch Fittings & Designer Pivots
 Offset Hung Patch Fittings
 Headers & Accessories
 Closers & Hardware
 Locksets
 Pulls & Handles
 Sliding Systems
 MANET
 Panic Hardware

DRS-120 Sliding System, Ceiling Mount

Two Sliding Panels with Two Fixed Panels

Model	Ref. #	U/M	Description	Standard Finishes \$					Custom Powder \$
				101	108/109	503/599	600/601	700/701	999
Two Sliding Panels with Two Fixed Panels, Complete				3	3	(SO)	(SO)	3	(SO)
Square									
	207.063	Ea.	Panel Width 20" to 35"	3,056	3,195	4,973	5,597	4,200	3,964
	207.064	Ea.	Panel Width 36" to 47"	3,231	3,416	5,845	6,630	4,812	4,441
	207.065	Ea.	Panel Width 48" to 59"	3,518	3,750	6,701	7,665	5,410	5,030
	207.066	Ea.	Panel Width 60" to 72"	3,804	4,081	7,556	8,699	6,006	5,618
Tapered									
	207.079	Ea.	Panel Width 20" to 35"	3,067	3,229	4,973	5,264	4,200	3,974
	207.080	Ea.	Panel Width 36" to 47"	3,251	3,465	5,845	6,560	4,812	4,460
	207.081	Ea.	Panel Width 48" to 59"	3,537	3,498	6,701	7,592	5,410	5,049
	207.082	Ea.	Panel Width 60" to 72"	3,823	4,146	7,556	8,627	6,006	5,638

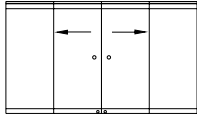

*See below for metric widths

Includes the following items

- One or two tracks (equal to 2 x panel widths)
- Two top 3-5/8" (92) DRS rails with rollers
- Brackets
- Panel guides and panel stops
- Two bottom 3-5/8" (92) DRS rails with lock
- Cylinder, thumbturn, and dust-proof strike
- Concealed floor guides
- Two top and bottom 3-5/8" (92) DRS Dri-Fit Sidelites, including angle brackets to attach Dri-Fit Sidelites to track
- Handles not included, optional

Calculations for ceiling mount with 2 overlapping edges

- Sliding Panel Widths = (Clear opening* + 2-3/4" (70)) / 2
- Track Length = Overall opening width
- Fixed Panel Width = (Overall opening width – clear opening* width)

* Allow for handle or lock projection when calculating.
 DRS lock projection allowance should be > 3" (76).
 (Clear opening + 1-3/8" [35] + panel projection allowance for handle/lock)

- 3** Standard or Non-Standard Fabricated; lead time up to 3 business days.
- (SO)** Special Fabricated/Finish or Special Order; lead time up to 5 weeks.

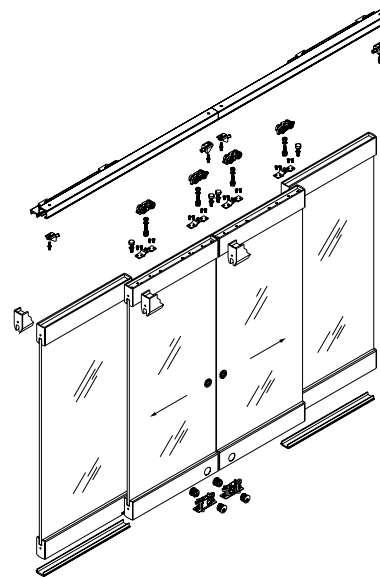

* Equivalent metric widths:
 20" to 35" = 508 to 889
 36" to 47" = 914 to 1,194
 48" to 59" = 1,219 to 1,499
 60" to 72" = 1,524 to 1,829

NOTE: For DRS covers refer to page 23.

RS-120 Sliding System, Wall and Ceiling Mount

Single Sliding Panel

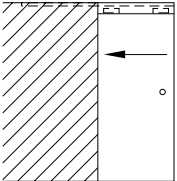
Model	Ref. #	U/M Description	Standard Finishes \$			Custom Powder \$
			101	108	700/701	999
Single Sliding Panel, Complete			3	SO	SO	SO
	207.001	Ea. Panel Width 20" to 35"	839	913	1,083	1,131
	207.002	Ea. Panel Width 36" to 47"	873	970	1,197	1,261
	207.003	Ea. Panel Width 48" to 59"	904	1,026	1,310	1,390
	207.004	Ea. Panel Width 60" to 72"	936	1,083	1,423	1,520

*See below for metric widths

NOTE:

For track lengths exceeding 2 times the panel width, a list charge of \$130/ft. will be applied.

Includes the following items

- Track (2 × panel width)
- Two covers (equal to panel width)
- Roller package with guide
- Handle and locks not included, optional

NOTE: For wall mount, request single full length cover (equal to track).

Calculations for wall mount with 2 overlapping edges

- Sliding Panel Width = Clear opening* + 3-1/8" (79)
- Track Length = (Clear opening* + 3-1/8" (79)) × 2

Calculations for ceiling mount with 1 overlapping edge

- Sliding Panel Width = Clear opening* + 1-9/16" (39)
- Track Length = (Clear opening* + 1-9/16" (39)) × 2

* Allow for handle or lock projection when calculating:
(Clear opening + 1-9/16" [39] + panel projection allowance for handle/lock)

3 Standard or Non-Standard Fabricated; lead time up to 3 business days.

SO Special Fabricated/Finish or Special Order; lead time up to 5 weeks.

NOTES:

- When ordering, please specify glass thickness and sliding panel width.
- Track will be spliced when length exceeds 157" (4 m).
- Maximum weight of sliding panel with two rollers = 264 lb (120 kg).
- Maximum weight of sliding panel with additional third roller package = 330 lb (150 kg).
- See pages 201-202 for RS-120 accessories.

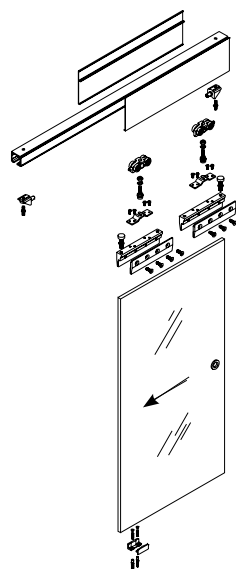

† Equivalent metric widths:
20" to 35" = 508 to 889
36" to 47" = 914 to 1,194
48" to 59" = 1,219 to 1,499
60" to 72" = 1,524 to 1,829

DRS Rails, Channels & Accessories

Patch Fittings & Designer Pivots

Offset Hung Patch Fittings

Headers & Accessories

Closers & Hardware

Locksets

Pulls & Handles

Sliding Systems

MANET

Panic Hardware

RS-120 Sliding System, Wall and Ceiling Mount

Single Sliding Panel with One Fixed Panel

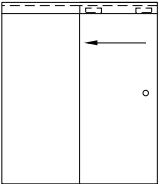
Model	Ref. #	U/M	Description	Standard Finishes \$			Custom Powder \$
				101	108	700/701	999
Single Sliding Panel with Fixed Panel, Complete				3	(S0)	(S0)	(S0)
	207.009	Ea.	Panel Width 20" to 35"	1,133	1,280	1,376	1,716
	207.010	Ea.	Panel Width 36" to 47"	1,258	1,454	1,582	2,036
	207.011	Ea.	Panel Width 48" to 59"	1,385	1,628	1,790	2,357
	207.012	Ea.	Panel Width 60" to 72"	1,509	1,801	1,996	2,675

*See below for metric widths

NOTE:

For track lengths exceeding 2 times the panel width, a list charge of \$130/ft. will be applied.

Includes the following items

- Track (equal to 2 x width)
- Two covers (equal to track)
- Top sidelite extrusion (equal to track)
- Bottom view protection
- Bottom sidelite Dri-Fit channel with gasket (equal to fixed panel width)
- Roller package with guide
- Handle and locks not included, optional

Calculations for ceiling mount with 1 overlapping edge

- Sliding Panel Width = Clear opening* + 1-9/16" (39)
- Track Length = Overall opening width
- Fixed Panel Width = Overall opening width – clear opening* width

* Allow for handle or lock projection when calculating:
(Clear opening + 1-9/16" [39] + panel projection allowance for handle lock)

3 Standard or Non-Standard Fabricated; lead time up to 3 business days.

(S0) Special Fabricated/Finish or Special Order; lead time up to 5 weeks.

NOTES:

- When ordering, please specify glass thickness and sliding panel width.
- Track, sidelite channel, and covers will be spliced when length exceeds 157" (4 m).
- Maximum weight of sliding panel with two rollers = 264 lb (120 kg).
- Maximum weight of sliding panel with additional third roller package = 330 lb (150 kg).
- See pages 201-202 for RS-120 accessories.

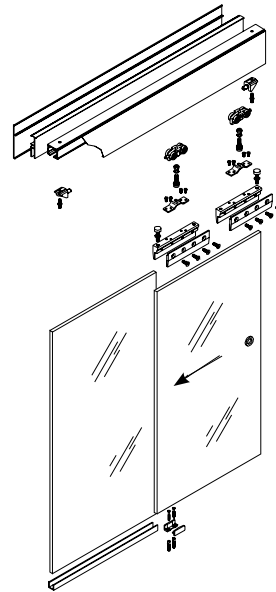

* Equivalent metric widths:
 20" to 35" = 508 to 889
 36" to 47" = 914 to 1,194
 48" to 59" = 1,219 to 1,499
 60" to 72" = 1,524 to 1,829

RS-120 Sliding System, Wall and Ceiling Mount

Two Sliding Panels

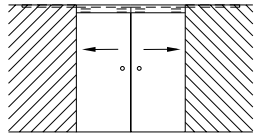
Model	Ref. #	U/M	Description	Standard Finishes \$			Custom Powder \$
				101	108	700/701	999
Two Sliding Panels, Complete				3	(SO)	(SO)	(SO)
	207.005	Ea.	Panel Width 20" to 35"	1,679	1,825	2,166	2,263
	207.006	Ea.	Panel Width 36" to 47"	1,744	1,939	2,392	2,522
	207.007	Ea.	Panel Width 48" to 59"	1,809	2,053	2,619	2,781
	207.008	Ea.	Panel Width 60" to 72"	1,874	2,166	2,846	3,040

*See below for metric widths

NOTE:

For track lengths exceeding 2 times the panel width, a list charge of \$130/ft. will be applied.

Includes the following items

- Two tracks (each 2 x single panel width)
- Two covers (equal to clear opening width)
- Roller package with guide
- Handle and locks not included, optional

NOTE: For wall mount, request single full length cover (equal to track).

Calculations for wall mount with 2 overlapping edges

- Sliding Panel Widths = (Clear opening* + 3-1/8" (79)) / 2
- Track Length = (Clear opening* + 3-1/8" (79)) x 2

Calculations for ceiling mount with 2 overlapping edges

- Sliding Panel Width = (Clear opening* + 3-1/8" (79)) / 2
- Track Length = (Clear opening* + 3-1/8" (79)) x 2

* Allow for handle or lock projection when calculating:
(Clear opening + 3-1/8" [79] + panel projection allowance for handle/lock)

3 Standard or Non-Standard Fabricated; lead time up to 3 business days.

(SO) Special Fabricated/Finish or Special Order; lead time up to 5 weeks.

NOTES:

- When ordering, please specify glass thickness and sliding panel widths.
- Track and covers will be spliced when length exceeds 157" (4 m).
- Maximum weight of sliding panel with two rollers = 264 lb (120 kg).
- Maximum weight of sliding panel with additional third roller package = 330 lb (150 kg).
- See pages 201-202 for RS-120 accessories.

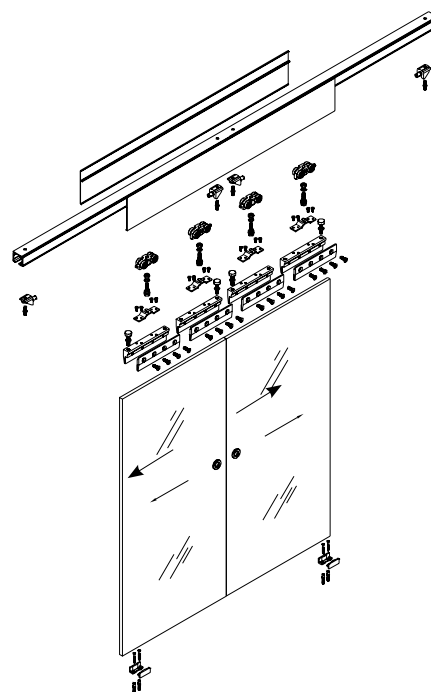

† Equivalent metric widths:
 20" to 35" = 508 to 889
 36" to 47" = 914 to 1,194
 48" to 59" = 1,219 to 1,499
 60" to 72" = 1,524 to 1,829

- DRS Rails, Channels & Accessories
- Patch Fittings & Designer Pivots
- Offset Hung Patch Fittings
- Headers & Accessories
- Closers & Hardware
- Locksets
- Pulls & Handles
- Sliding Systems
- MANET
- Panic Hardware

RS-120 Sliding System, Wall and Ceiling Mount

Two Sliding Panels with Two Fixed Panels

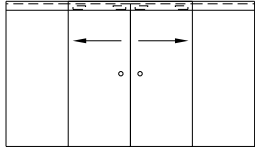
Model	Ref. #	U/M	Description	Standard Finishes \$			Custom Powder \$
				101	108	700/701	999
Two Sliding Panels with Two Fixed Panels, Complete				3	(SO)	(SO)	(SO)
	207.013	Ea.	Panel Width 20" to 35"	2,266	3,650	2,752	3,432
	207.014	Ea.	Panel Width 36" to 47"	2,517	3,877	2,841	4,073
	207.015	Ea.	Panel Width 48" to 59"	2,768	4,104	3,578	4,712
	207.016	Ea.	Panel Width 60" to 72"	3,019	4,331	3,991	5,351

***See below for metric widths**

NOTE:
For track lengths exceeding 2 times the panel width, a list charge of \$130/ft. will be applied.

Includes the following items

- One or two tracks (equal to 2 x panel width)
- Two covers (equal to track or tracks)
- Top sidelite extrusion (equal to track or tracks)
- Bottom view protection (equal to clear opening width)
- Two bottom sidelite Dri-Fit channels with gasket (equal to fixed panel width)
- Roller package with guide
- Handle and locks not included, optional

Calculations for ceiling mount with 2 overlapping edges

- Sliding Panel Widths = (Clear opening* + 3-1/8" (79)) / 2
- Track Length = Overall opening width
- Fixed Panel Width = (Overall opening width – clear opening* width) / 2

* Allow for handle or lock projection when calculating:
(Clear opening + 3-1/8" [79] + panel projection allowance for handle/lock)

3 Standard or Non-Standard Fabricated; lead time up to 3 business days.

(SO) Special Fabricated/Finish or Special Order; lead time up to 5 weeks.



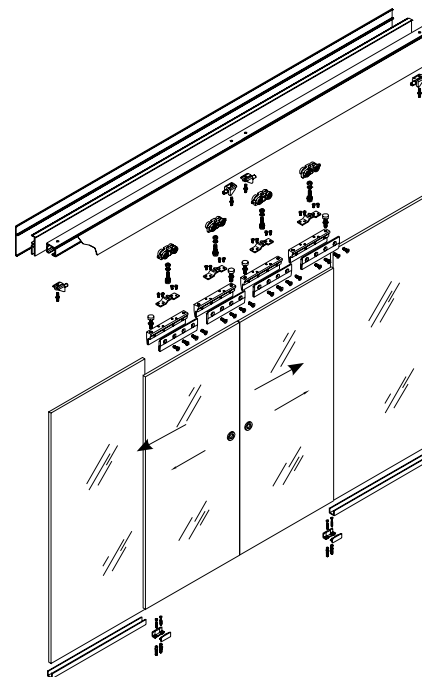

NOTES:

- When ordering, please specify glass thickness and sliding panel widths.
- Track, sidelite channel, and covers will be spliced when length exceeds 157" (4 m).
- Maximum weight of sliding panel with two rollers = 264 lb (120 kg).
- Maximum weight of sliding panel with additional third roller package = 330 lb (150 kg)
- See pages 201-202 for RS-120 accessories.

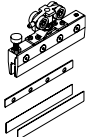
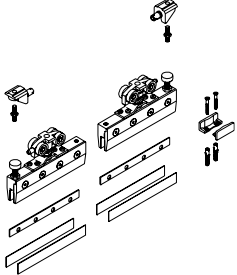
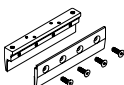

* Equivalent metric widths:
20" to 35" = 508 to 889
36" to 47" = 914 to 1,194
48" to 59" = 1,219 to 1,499
60" to 72" = 1,524 to 1,829

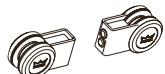
RS-120 Accessories and Components

Model	Ref. #	U/M	Description	Finishes \$	
				101	
Single Roller Package, Complete				(S0)	
	907.123	Ea.	Single Roller Package	164	(1)
Double Roller Package, Complete				376 (1)	
	907.125	Ea.	Double Roller Package	376	(1)
Hardware					
	907.124	Ea.	Fitting for 3/8" (10) Glass	85	
	807.118	Ea.	Shim for 1/2" (12) Glass	16	
	907.900	Ea.	Shim for 5/16" (8) Glass (gasket)	12	
				108/109	
	829.420	Ea.	Spacer for Bi-Parting Sliding Panels	106	
Endcaps					
	907.127	Ea.	Wall Mounted (without sidelite)	35	85 (S0) (108 only)
	907.129	Ea.	Endcap for Track when Ceiling Mounted (without sidelite)	35	82 (S0)

(1) Non-Fabricated item, ships in 1 business day.

(S0) Special Fabricated/Finish or Special Order; lead time up to 5 weeks.

DRS Rails, Channels & Accessories

Patch Fittings & Designer Pivots

Offset Hung Patch Fittings

Headers & Accessories

Closers & Hardware

Locksets









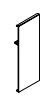

Pulls & Handles

Sliding Systems

MANET

Panic Hardware

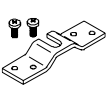
RS-120 Accessories and Components

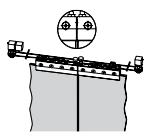
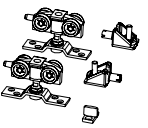
Model	Ref. #	U/M	Description	Standard Finishes \$				Custom Powder \$	List \$
				101	108/109	700/701	113	999	
Extrusions and Accessories									
	907.120	Ft.	RS Cover	17 ³	30 ^(SO) (108 only)	—	28 ^(SO)	41 ^(SO)	
	207.980	Ft.	RS Cover Cladded	—	—	59 ^(SO)	—	—	
	907.126	Ea.	Floor Guide	—	15 ^(SO) (109 only)	—	—	—	
				108			999		List \$
	907.121	Ln.	RS Track Length = 157" (4 m)	—	—	—	669 ^(SO)	381 ³	
	907.122	Ft.	RS Sidelite Channel 5/16" (8), 3/8" (10), 1/2" (12)	—	—	—	52 ^(SO)	28 ³	
	907.138	Ft.	Bottom View Protector (used with Sidelites)	5	8	—	—	—	
	907.997	Ea.	Panel Guide	—	—	—	—	9	
	907.998	Ea.	Panel Stop	—	—	—	—	17	
	907.704	Ea.	Roller	—	—	—	—	27	
	907.996	Ea.	Roller Screw	—	—	—	—	9	
	907.999	Ea.	Roller Bracket	—	—	—	—	18	
	932.988	Ea.	Floor Guide	—	—	—	—	31	
RS-120 Synchronized Glass Applications									
	907.150	Ea.	Syncro Bi-Parting Roller Package (includes 2 sets of roller packages 07.125 and the cable set with blocks and pulleys)	1,273 ^(SO)					
NOTE: Track covers, view protection, and sidelite channel sold separately above									
RS-120 Wood Applications									
	807.135	Ea.	Wood Roller Package (track and covers sold separately above)	173 ^(SO)					

① Non-Fabricated item, ships in 1 business day.







③ Standard or Non-Standard Fabricated; lead time up to 3 business days.

^(SO) Special Fabricated/Finish or Special Order; lead time up to 5 weeks.

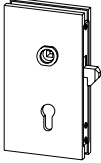
NOTES:

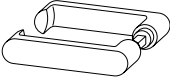
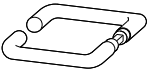
- Track sold in stock lengths ONLY.
- dormakaba will cut to specific length at no charge; drop length will not be sent unless specified on purchase order.
- Maximum extrusion length is 157" (4 m) unless otherwise indicated above. Stainless steel covers max. length 144" (3.66 m).

Sliding Applications Handle Options

			Finishes \$			
Ref. #	U/M	Description	101	105	108/109	199
General Accessories			8W	8W	8W	
	905.202	Ea. Hook Lock (includes wall mounted strike plate)	396	515	661	—
	905.201	Ea. Strike Box	396	469	661	—
	910.314	Set Set of Flat Lever Handles	62 5	80 8W	—	113 8W
	910.301	Set Set of Tubular Lever Handles	137 5	154	—	198
			113			
	907.200	Set Flush Pull	134 1	201 1	—	201 8W
Europrofile Accessories				503/599	700/701	
	901.003	Ea. Profile Key Cylinder		91 8W	67 8W	
	901.002	Profile Thumbturn Cyl.		88	74	
	901.004	Ea. Right Handed Cam		88	74	
		Ea. Left Handed Cam		88	74	

- 5 Non-Fabricated item, ships in 5 business days.
- 1 Non-Fabricated item, ships in 1 business day.
- 8W Special Fabricated/Finish or Special Order; lead time up to 5 weeks.

NOTES:

- Euro cylinders are KA by default and KD is a special order.
- LH Housing requires RH cylinder; RH Housing requires LH cylinder.
- For 108 or 109 finish trim specify 199 and specify "to be finished black or dark bronze."

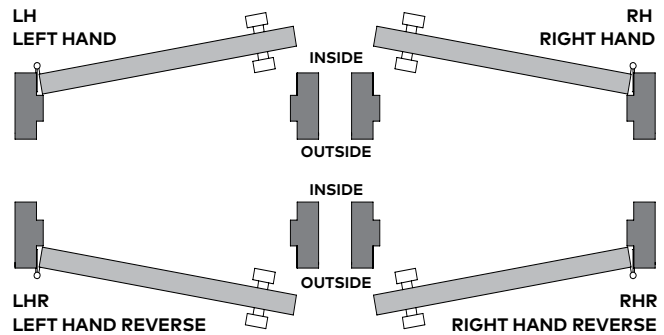

DRS Rails, Channels & Accessories
Patch Fittings & Designer Pivots
Offset Hung Patch Fittings
Headers & Accessories
Closers & Hardware
Locksets
Pulls & Handles
Sliding Systems
MANET
Panic Hardware

MANET Pivoting/Sliding Door Systems

MANET Compact	Pivoting Doors	206
	Sliding Doors	209
	Handles and Knobs	214
	Options and Accessories	215
MANET Accessories	Wet Environment Components (316 Stainless Steel)	221
	Wood Door Components	223
	Clamp Bracket Reference Chart	224

- DRS Rails, Channels & Accessories
- Patch Fittings & Designer Pivots
- Offset Hung Patch Fittings
- Headers & Accessories
- Closers & Hardware
- Locksets
- Pulls & Handles
- Sliding Systems
- MANET**
- Panic Hardware

MANET Set 1 Pivoting

Without transom for 3/8" to 1/2" (10 to 12) glass

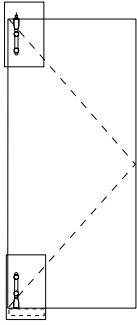
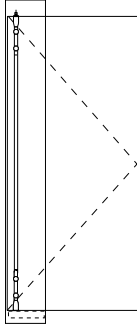
				Finish \$
MANET Compact Set 1	Ref. #	U/M	Description	700
	829.910	Unit	SET 1 Consisting of: Pair of top/bottom pivot poles, short type Including: • 4 Single-point fittings for pivot poles • 1 Top pivot bearing • 1 Eccentric pivot bushing for ceiling install • 1 Bottom pivot bearing for BTS75V or floor pivot	447 ^①
	829.911	Unit	SET 1 with connecting tube Consisting of: Pair of top/bottom pivot poles, long type, connecting tube Including: • 4 Single-point fittings for pivot poles • 1 Top pivot bearing • 1 Eccentric pivot bushing for ceiling install • 1 Bottom pivot bearing for BTS75V or floor pivot • 1 Connecting tube at 85-7/16" (2170)	469 ^{SO}

Application example for Set 1
 For detail information see Brochure **MANET Point fittings for interior applications.**

Door type 1

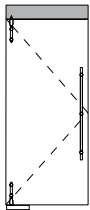

Door type 2

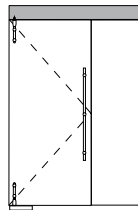

Door type 3

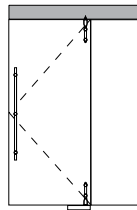

Door type 4

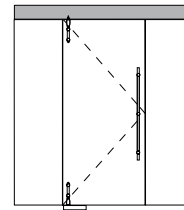

Door type 5

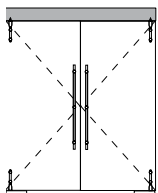

Door type 6

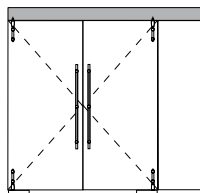

Door type 7

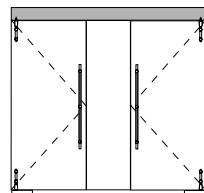

Door type 8

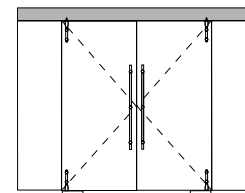

- ① Non-Fabricated item, ships in 1 business day.
- SO Special Order; lead time up to 5 weeks.

NOTE: For handles, knobs, and other options and accessories, see pages 214–216.

MANET Set 2 Pivoting

With transom for 3/8" to 1/2" (10 to 12) glass

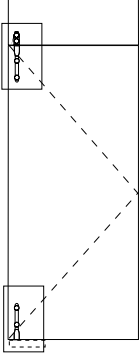
				Finish \$
MANET Compact Set 2	Ref. #	U/M	Description	700
	829.912	Unit	SET 2 Consisting of: Pair of top/bottom pivot poles, short type Including: • 4 Single-point fittings for pivot poles • 1 Top pivot bearing • 1 Pivot bearing location for transom • 1 Bottom pivot bearing for BTS75V or floor pivot	579 (SO)
	829.913	Unit	SET 2 with connecting tube Consisting of: Pair of top/bottom pivot poles, long type, connecting tube Including: • 4 Single-point fittings for pivot poles, • 1 Top pivot bearing, • 1 Pivot bearing location for transom, • 1 Bottom pivot bearing for BTS75V or floor pivot • 1 Connecting tube at 85-7/16" (2170)	602 (SO)

Application example for Set 2
 For detail information see the brochure **MANET Point fittings for interior applications.**

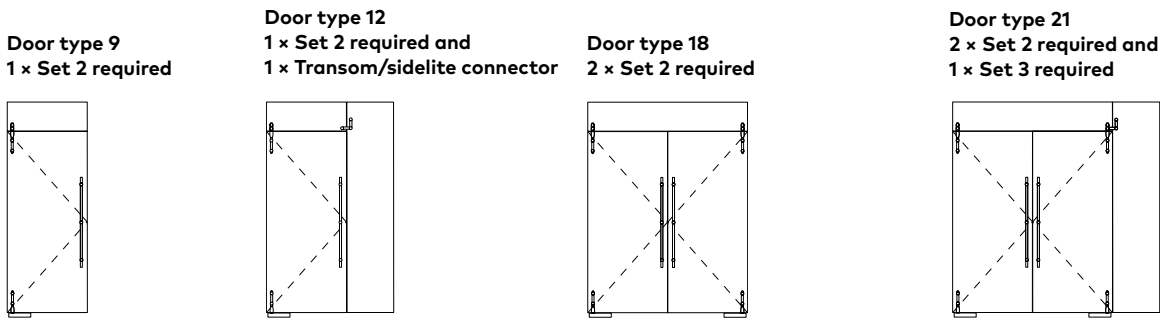

(SO) Special Order; lead time up to 5 weeks.

NOTE: For handles, knobs, and other options and accessories, see pages 214–216.

- DRS Rails, Channels & Accessories
- Patch Fittings & Designer Pivots
- Offset Hung, Patch Fittings
- Headers & Accessories
- Closers & Hardware
- Locksets
- Pulls & Handles
- Sliding Systems
- MANET
- Panic Hardware

MANET Set 3 Pivoting

With transom and sidelite for 3/8" to 1/2" (10 to 12) glass

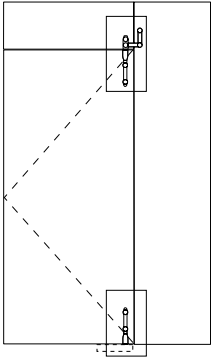
MANET Compact Set 3	Ref. #	U/M Description	Finish \$
	829.914	Unit SET 3 Consisting of: Pair of top/bottom pivot poles, short type Including: • 4 Single-point fittings for pivot poles • 1 Top pivot bearing • 1 Transom/sidelite connector with pivot bearing location • 1 Bottom pivot bearing for BTS75V or floor pivot	701 ^①
	829.915	Unit SET 3 Consisting of: Pair of top/bottom pivot poles, long type, connecting tube Including: • 4 Single-point fittings for pivot poles • 1 Top pivot bearing • 1 Transom/sidelite connector with pivot bearing location • 1 Bottom pivot bearing for BTS75V or floor pivot • 1 Connecting tube at 85-7/16" (2170)	725 ^{SO}

Application example for Set 3
 For detail information see the brochure **MANET Point fittings for interior applications.**

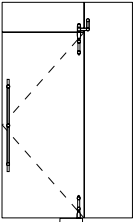
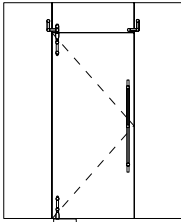
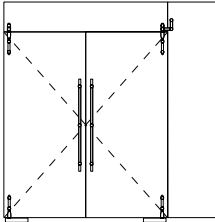
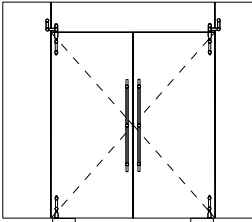
<p>Door type 13 1 x Set 3 required</p> 	<p>Door type 15 1 x Set 3 required and 1 x Transom/sidelite connector</p> 	<p>Door type 21 2 x Set 2 required and 1 x Set 3 required</p> 	<p>Door type 23 2 x Set 3 required</p> 
---	--	--	---

^① Non-Fabricated item, ships in 1 business day.
^{SO} Special Order; lead time up to 5 weeks.

NOTE: For handles, knobs, and other options and accessories, see pages 214–216.

MANET Set 4.1 Sliding

Wall mount for 3/8" to 1/2" (10 to 12) glass

Countersunk single-point fittings

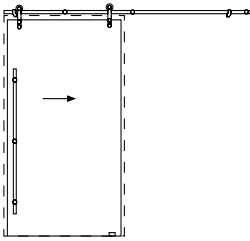
MANET Compact Set 4.1	Ref. #	U/M	Description	Finish \$
	829.916	Unit	SET 4.1 Consisting of: <ul style="list-style-type: none"> • 5 Clamp brackets track/wall • 2 Roller carriers; includes single-point fittings 5/16"–1/2" (8–12) glass • 1 Door stop LH • 1 Door stop RH • 1 Floor guide AGILE • Assembly tool 	700 1,098 ^①
	821.527	Ln.	Sliding track tube including end caps; length 118" (3 m) track NOTE: Sliding track tube must be ordered separately with the above set in order to receive a complete system.	169 ^①

^① Non-Fabricated item, ships in 1 business day.

NOTE: For handles, knobs, and other options and accessories, see pages 214–216.

DRS Rails, Channels & Accessories

Patch Fittings & Designer Pivots

Offset Hung Patch Fittings

Headers & Accessories

Closers & Hardware

Locksets

Pulls & Handles

Sliding Systems

MANET

Panic Hardware

MANET Set 4.2 Sliding

Wall mount for 3/8" to 1/2" (10 to 12) glass

Clamping disk single-point fittings

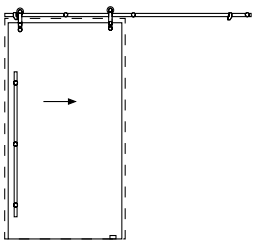
			Finish \$
MANET Compact Set 4.2	Ref. #	U/M Description	700
	829.917	Unit SET 4.2 Consisting of: <ul style="list-style-type: none"> • 5 Clamp brackets track/wall • 2 Roller carriers; includes single-point fittings 5/16"–1/2" (8–12) glass • 1 Door stop LH • 1 Door stop RH • 1 Floor guide AGILE • Assembly tool 	1,119 ①
	821.527	Ln. Sliding track tube including end caps; length 118" (3 m) track NOTE: Sliding track tube must be ordered separately with the above set in order to receive a complete system.	169 ①

① Non-Fabricated item, ships in 1 business day.

NOTE: For handles, knobs, and other options and accessories, see pages 214–216.

MANET Set 5.1 Sliding

Glass mount, connected to wall on one side for 3/8" to 1/2" (10 to 12) glass
Countersunk single-point fittings

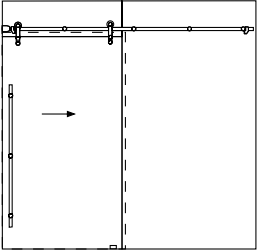
				Finish \$
MANET Compact Set 5.1	Ref. #	U/M	Description	700
	829.918	Unit	SET 5.1 Consisting of: <ul style="list-style-type: none"> • 6 Clamp brackets for glass, countersunk • 2 Roller carriers; includes single-point fitting 5/16"-1/2" (8-12) glass • 1 Wall fitting, flattened • 1 Door stop LH • 1 Door stop RH • 1 Floor guide AGILE • Assembly tool 	1,355 ^①
	821.527	Ln.	Sliding track tube including end caps; length 118" (3 m) track NOTE: Sliding track tube must be ordered separately with the above set in order to receive a complete system.	169 ^①

^① Non-Fabricated item, ships in 1 business day.

NOTE: For handles, knobs, and other options and accessories, see pages 214–216.

DRS Rails, Channels & Accessories

Patch Fittings & Designer Pivots

Offset Hung Patch Fittings

Headers & Accessories

Closers & Hardware

Locksets

Pulls & Handles

Sliding Systems

MANET

Panic Hardware

MANET Set 5.2 Sliding

Glass mount, connected to wall on one side for 3/8" to 1/2" (10 to 12) glass
Clamping disk single-point fittings

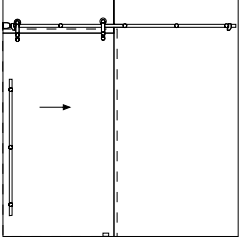
MANET Compact Set 5.2	Ref. #	U/M	Description	Finish \$
	829.919	Unit	SET 5.2 consisting of: <ul style="list-style-type: none"> • 6 Clamp brackets for glass, clamping disk single-point fittings • 2 Roller carriers; includes single-point fittings 5/16"-1/2" (8-12) glass • 1 Wall fitting, flattened • 1 Door stop LH • 1 Door stop RH • 1 Floor guide AGILE • Assembly tool 	700 1,434 (SO)
	821.527	Ln.	Sliding track tube including end caps; length 118" (3 m) track NOTE: Sliding track tube must be ordered separately with the above set in order to receive a complete system.	169 (1)

(1) Non-Fabricated item, ships in 1 business day.

(SO) Special Order; lead time up to 5 weeks.

NOTE: For handles, knobs, and other options and accessories, see pages 214–216.

MANET Set 6.1 Sliding

Glass mount, sidelite both sides for 3/8" to 1/2" (10 to 12) glass
glass countersunk single-point fittings

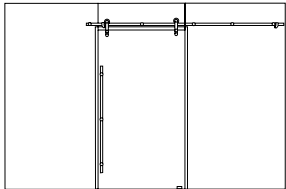
MANET Compact Set 6.1	Ref. #	U/M	Description	Finish \$
	829.920	Unit	SET 6.1 consisting of: <ul style="list-style-type: none"> • 7 Clamp brackets for glass • 2 Roller carriers; includes single-point fittings 5/16"-1/2" (8-12) glass • 1 Door stop LH • 1 Door stop RH • 1 Floor guide AGILE • Assembly tool 	700 1,361 (1)
	821.527	Ln.	Sliding track tube including end caps; length 118" (3 m) track NOTE: Sliding track tube must be ordered separately with the above set in order to receive a complete system.	169 (1)

(1) Non-Fabricated item, ships in 1 business day.

NOTE: For handles, knobs, and other options and accessories, see pages 214–216.

MANET Set 6.2 Sliding

Glass mount, sidelite both sides for 3/8" to 1/2" (10 to 12) glass

Clamping disk single-point fittings

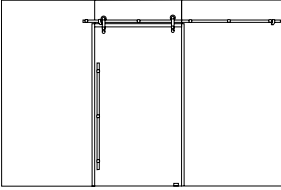
MANET Compact Set 6.2			Finish \$
Ref. #	U/M Description	700	
	829.921 Unit SET 6.2 consisting of:	1,507 ^(SO)	
	<ul style="list-style-type: none"> • 7 Clamp brackets for glass , clamping disk single-point fittings • 2 Roller carriers; includes single-point fittings 5/16"–1/2" (8–12) glass • 1 Door stop LH • 1 Door stop RH • 1 Floor guide AGILE • Assembly tool 		
821.527	Ln. Sliding track tube including end caps; length 118" (3 m) track NOTE: Sliding track tube must be ordered separately with the above set in order to receive a complete system.	169 ⁽¹⁾	

⁽¹⁾ Non-Fabricated item, ships in 1 business day.

^(SO) Special Order; lead time up to 5 weeks.

NOTE: For handles, knobs, and other options and accessories, see pages 214–216.

DRS Rails,
Channels &
Accessories

Patch Fittings
& Designer
Pivots

Offset
Hung Patch
Fittings

Headers &
Accessories

Closers &
Hardware

Locksets

Pulls &
Handles





Sliding
Systems

MANET

Panic
Hardware

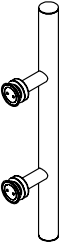
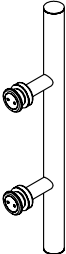
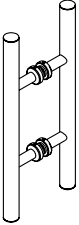
MANET Compact Sets

Handles and Knobs













Handles and Knobs	Ref. #	U/M Description	Finish \$
Handle, single side, countersunk for 5/16", 3/8", and 1/2" (8/10/12) glass for MANET Compact Sets 1, 2, 3, 4.1, 5.1, and 6.1			(SO)
 <p>829.268 (shown)</p>	829.268	Ea. Length 13-25/32" (350) 2F	234
	829.271	Ea. Length 28-11/32" (720) 2F	310
	829.274	Ea. Length 48-13/16" (1240) 3F	385
	829.277	Ea. Length 69-9/16" (1760) 4F	460
Handle, single side, clamping disk for 5/16", 3/8", and 1/2" (8/10/12) glass for MANET Compact Sets 4.2, 5.2, and 6.2			
 <p>821.240 (shown)</p>	821.240	Ea. Length 13-25/32" (350) 2F	234
	821.241	Ea. Length 28-11/32" (720) 2F	286
	821.242	Ea. Length 48-13/16" (1240) 3F	412
	821.243	Ea. Length 69-5/16" (1760) 4F	507
Handle, back to back for 5/16", 3/8", and 1/2" (8/10/12) glass			
 <p>821.269 (shown)</p>	821.269	Ea. Length 13-25/32" (350) 2F	315
	821.270	Ea. Length 28-3/8" (720) 2F	432 (1)
	821.273	Ea. Length 48-13/16" (1240) 3F	540 (1)
	821.276	Ea. Length 69-5/16" (1760) 4F	650 (1)
Knobs			
	821.423	Ea. Knob, back to back; 5/16"-1/2" (8-12) glass	127
	821.422	Ea. Knob, single side 5/16"-1/2" (8-12) glass with countersunk single point fitting (MANET Compact Sets 4.1, 5.1, and 6.1)	142
	821.426	Ea. Knob, single side 5/16"-1/2" (8-12) glass with clamping disk single point fitting (MANET Compact Sets 4.2, 5.2, and 6.2)	150

(1) Non-Fabricated item, ships in 1 business day.

(SO) Special Order; lead time up to 5 weeks.

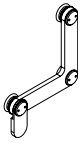
MANET Compact Sets

Options and Accessories

Accessories	Ref. #	U/M	Description	Finish \$
				①
	821.334	Ea.	Stop for pivoting door, ceiling mounted (MANET Compact Set 1 only)	75
	829.335	Ea.	Door stop at transom (inside/outside) for 3/8"–1/2" (10–12) glass (MANET Compact Sets 2 & 3 only)	128
	829.145	Ea.	G/C or G/F connector 90° (support only, no carrying function) (MANET Compact Set 1 only)	131
	829.337	Ea.	Ceiling connector for 5/16"–1/2" (8–12) glass (MANET Compact Sets 1, 2, 3, 5.1 & 6.1 only)	160
	821.449	Ea.	Top/Bottom lock with profile cylinder rose inside for 5/16"–1/2" (8–12) glass	239
	814.206	Ea.	Profile cylinder (for 821.448/449) (Mill Finish only)	34
	805.194	Ea.	Eccentric pivot bushing (for 821.448/449)	54
	829.320	Ea.	Transom/sidelite connector for 3/8"–1/2" (10–12) glass (MANET Compact Sets 2 & 3 only)	236
 829.322 (shown)	829.322	Ea.	Transom/sidelite connector with inside stop for 3/8"–1/2" (10–12) glass (MANET Compact Sets 2 & 3 only)	332
	829.324	Ea.	Transom/sidelite connector with outside stop for 3/8" (10) glass (MANET Compact Sets 2 & 3 only)	332
	829.325	Ea.	Transom/sidelite connector with outside stop for 1/2" (12) glass (MANET Compact Sets 2 & 3 only)	332
				List \$
	829.338	Ea.	Ceiling connector for 5/16"–1/2" (8–12) glass (MANET Compact Sets 5.2 & 6.2 only)	160 (SO)
	821.134	Ea.	Assembly tool, MANET single point fittings (Mill Finish)	24 (SO)
	829.217	Ea.	5 pcs. clip-on covers for single point fittings with spring	34 (SO)
	821.432	Ea.	Guide rail with brush seals aluminum; total length 118" (3 m) (MANET Compact Sets 4.1, 4.2, 5.1, 5.2, 6.1 & 6.2 only) (Mill Finish)	182 (SO)

① Non-Fabricated item, ships in 1 business day.

(SO) Special Order; lead time up to 5 weeks.

DRS Rails, Channels & Accessories

Patch Fittings & Designer Pivots

Offset Hung Patch Fittings

Headers & Accessories

Closers & Hardware

Locksets

Pulls & Handles

Sliding Systems

MANET

Panic Hardware

MANET Single-Point Fittings

	Ref. #	U/M	Description	Finish \$
	Single point (3/8") glass to wall			(SO)
	829.200	Ea.	5/16"-7/16" (8-11.5) adjustable	52
	829.201	Ea.	7/16"-9/16" (11.5-14.5) adjustable	52
	829.202	Ea.	9/16"-11/16" (14.5-22) adjustable	52
	Single point (1/2") glass to wall			
	829.210	Ea.	5/16"-7/16" (8-11.5) adjustable	60
	829.211	Ea.	7/16"-9/16" (11.5-14.5) adjustable	60
	829.212	Ea.	9/16"-11/16" (14.5-22) adjustable	60
	Single point (varies) glass to wall			
	829.205	Ea.	5/16"-3/8" (8-10) NOT adjustable	34
	829.215	Ea.	1/2" (12) NOT adjustable	41
	829.217	Ea.	5 pcs. clip-on covers for single point fittings with spring	34



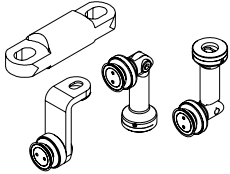
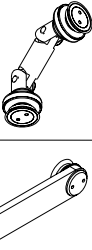

MANET Connecting System

	Ref. #	U/M	Description	Finish \$
Connecting rods				(SO)
	821.355	Ea.	Length 2-1/16" (52.5)	52
	829.145	Ea.	G/C or G/F connector 90° (support only, no carrying function)	131 (1)
	829.337	Ea.	Ceiling connector countersunk (carrying function)	160 (1)
	829.338	Ea.	Ceiling connector countersunk (clamping disk)	160
Glass to glass corner connectors 90°-180° for 5/16"-1/2" glass				
	829.120	Ea.	Connecting rod length 2-1/16" (52.5)	154
	829.122	Ea.	Connecting rod length 2-23/64" (60)	154
	829.125	Ea.	Connecting rod length 3-7/32" (82)	154
	829.130	Ea.	Connecting rod length 4-1/16" (103)	154
	829.148		Connector for 5/16"-1/2" (8-12) glass	100 (1)

(1) Non-Fabricated item, ships in 1 business day.

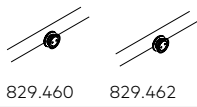
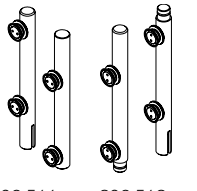
(SO) Special Order; lead time up to 5 weeks.

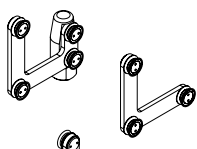
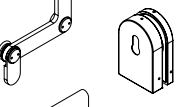
MANET Pivoting Door System

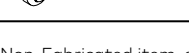
	Ref. #	U/M	Description	Finish \$
Single point, countersunk, track to glass				(S0)
	829.460	Ea.	Fixed 3/8", 1/2" (10, 12) glass	27
	829.462	Ea.	Centering 3/8", 1/2" (10, 12) glass	41
Top/Bottom pivot pole set				
	829.546	Ea.	Short type (including 4 single point fix)	235
	829.548	Ea.	Short type for intermediate tube (including 4 single point fix)	412
	829.553	Ea.	Pivot pole, full height, RTS88	489
Intermediate tube Dia 1" (25)				
	829.555	Ea.	Fix length up to 85-7/16" (2170)	110
Pivot bearings				
	821.310	Ea.	Transom and ceiling connection	93
	821.314	Ea.	RTS (not shown)	147
	829.545	Ea.	BTS/floor pivot	117
	829.333	Ea.	Transom for 5/16"-1/2" (8-12) glass	195
Transom/sidelite connector (right/left)				
	829.330	Ea.	With pivot bearing location, complete for 3/8", 1/2" (10, 12) glass	342
	829.320	Ea.	For 3/8", 1/2" (10, 12) glass	236 (1)
	829.322	Ea.	With stop inside for 3/8", 1/2" (10, 12) glass	332
	829.324	Ea.	With stop outside for 3/8" (10) glass (not shown)	332
	829.325	Ea.	With stop outside for 1/2" (12) glass (not shown)	332
	821.449	Ea.	Top/Bottom deadlock w/ profile cylinder rose on inside for 5/16"-1/2" (8-12) glass	239 (1)
	814.206	Ea.	Profile cylinder (for 821.448/449)	34 (1)
	821.334	Ea.	Stop for pivoting door, ceiling mounted	75
	829.335	Ea.	Door stop at transom (inside/outside) for 3/8", 1/2" (10, 12) glass	128

(1) Non-Fabricated item, ships in 1 business day.

(S0) Special Order; lead time up to 5 weeks.

DRS Rails,
Channels &
Accessories

Patch Fittings
& Designer
Pivots

Offset
Hung Patch
Fittings

Headers &
Accessories

Closers &
Hardware

Locksets







Pulls &
Handles

Sliding
Systems

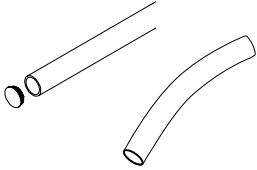
MANET

Panic
Hardware







MANET Sliding Door System

	Ref. #	U/M Description	Finish \$
Single point fitting for roller carrier			
	829.430	Set Countersunk for 5/16" -1/2" (8-12) glass	82 ^①
	829.432	Set Clamping disk for 5/16" -1/2" (8-12) glass (not shown)	82
Sliding track tube			
	821.527	Ea. Sliding track tube fixed length with end caps 118" (3 m) length	169 ^①
	821.413	Ea. Sliding track tube, bent r=min. 23-1/2" (600), max. curve length 18.5' (5.6 m) with end caps	1,729
	829.506	Ea. Connection sliding track tube (not shown)	55 ^①
Clamp bracket fitting track to:			
	829.176	Ea. Glass, countersunk single point fitting for 3/8" -1/2" (10-12) glass	95
	829.177	Ea. Glass, clamping disk single point fitting for 3/8" -1/2" (10-12) glass	95
	829.175	Ea. Wall	75
	821.316	Ea. Ceiling retainer for sliding track, carrying function	350
Wall fitting for track			^{SO}
	829.445	Ea. Round	69

^① Non-Fabricated item, ships in 1 business day.

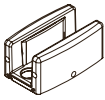
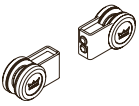
^{SO} Special Order; lead time up to 5 weeks.

MANET Pivoting/Sliding Door System

	Ref. #	U/M	Description	Finish \$
				700
Door stop				
	829.425	Ea.	Left hand	138
	829.426	Ea.	Right hand	138
Guides				
	821.432	Ea.	Guide rail brush seals, aluminum mill finish; stock length = 118" (3 m)	182 (SO)
				100
	807.326	Ea.	Floor guide, for mount onto floor 5/16" -1/2" (8-12) glass	69 (1)
				List \$
	829.420	Ea.	Spacer for Bi-Parting Sliding Panels	103 (SO)
	901.106.001	Ea.	Floor pivot (100 only) Adjustable 5/16" -1/2" (8-12) (no cover) (MANET Compact Sets 1, 2 & 3 only)	71 (1)
				700
	901.079	Ea.	Floor pivot cover	25 (1)
	926.870	Ea.	Decorative floor stop with Duraflex bumper (619 only, equivalent to 700)	619 52

(1) Non-Fabricated item, ships in 1 business day.

(SO) Special Order; lead time up to 5 weeks.

DRS Rails,
Channels &
Accessories

Patch Fittings
& Designer
Pivots

Offset
Hung Patch
Fittings

Headers &
Accessories

Closers &
Hardware

Locksets





Pulls &
Handles

Sliding
Systems

MANET

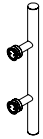
Panic
Hardware

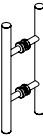
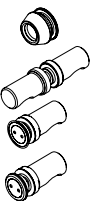
MANET Handles and Tools

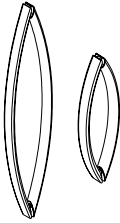



Handles and Knobs	Ref. #	U/M	Description	Finish \$
Handle, single side, countersunk for 5/16", 3/8", and 1/2" (8/10/12) glass				(SO)
	829.268	Ea.	Length 13-25/32" (350) 2F	234
	829.271	Ea.	Length 28-11/32" (720) 2F	310
	829.274	Ea.	Length 48-13/16" (1240) 3F	385
	829.277	Ea.	Length 69-5/16" (1760) 4F	460
Handle, single side, clamping disk for 5/16", 3/8", and 1/2" (8/10/12) glass				
	821.240	Ea.	Length 13-25/32" (350) 2F	234
	821.241	Ea.	Length 28-11/32" (720) 2F	286
	821.242	Ea.	Length 48-13/16" (1240) 3F	412
	821.243	Ea.	Length 69-5/16" (1760) 4F	507
Handle, back to back for 5/16", 3/8", and 1/2" (8/10/12) glass				
	821.269	Ea.	Length 13-25/32" (350) 2F	315 (1)
	821.270	Ea.	Length 28-3/8" (720) 2F	432
	821.273	Ea.	Length 48-13/16" (1240) 3F	540
	821.276	Ea.	Length 69-5/16" (1760) 4F	650
Knobs				
	821.290	Ea.	Recessed pull grip for 5/16", 3/8", 1/2" (8/10/12) glass	85
	821.422	Ea.	Knob, single side 5/16"-1/2" (8-12) glass with countersunk single point fitting	142
	821.426	Ea.	Knob, single side 5/16"-1/2" (8-12) glass with clamping disk single point fitting	150
	821.423	Ea.	Knob, back to back 5/16"-1/2" (8-12) glass	127
Tools				
	821.134	Ea.	Assembly tool, MANET single point fittings (No Finish)	24
	821.137	Ea.	Hole gauge (No Finish)	37
	821.995	Ea.	Sample case (not shown) (No Finish Designation)	1,016
ARCOS Handles				114
				(SO)
	826.500	Ea.	Back to back ARCOS 13-25/32" (350)	364
	826.510	Ea.	Back to back ARCOS 29-17/32" (750)	429

(1) Non-Fabricated item, ships in 1 business day.

(SO) Special Order; lead time up to 5 weeks.

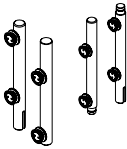
MANET Wet Environment Components

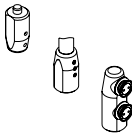
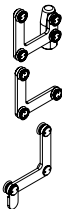
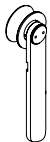
316 Stainless Steel

			Finish \$
Wet Environment Components	Ref. #	U/M Description	700
Ceiling connectors, 5/16"–1/2" (8–12) glass			(S0)
	829.339	Ea. Ceiling connectors; 5/16"–1/2" (8–12) glass (countersunk)	251
	829.340	Ea. Ceiling connectors; 5/16"–1/2" (8–12) glass (clamping disk); not shown	260
Wet single point, countersunk, track to glass			
	829.461	Ea. Fixed 3/8", 1/2" (10, 12) glass	35
	829.463	Ea. Centering 3/8", 1/2" (10, 12) glass	48
Wet intermediate tube dia. 1" (25)			
	829.557	Ea. Fixed length up to 85-7/16" (2170)	406
Wet pivot bearings			
	821.350	Ea. Transom and ceiling connection	112
	829.550	Ea. BTS/floor pivot	208
	829.353	Ea. Transom for 5/16"–1/2" (8–12) glass; not shown	297
	829.540	Ea. Floor pivot; max. door weight 132 lb (60 kg)	155
Wet transom/sidelite connector (right/left)			
	829.362	Ea. With pivot bearing location, complete for 3/8", 1/2" (10, 12) glass	444
	829.360	Ea. For 3/8", 1/2" (10, 12) glass	273
Wet sliding door systems (not shown)			
	829.423	Ea. Sliding door roller carrier with anti-jump mechanism; lug/roller only (2 fittings required per roller, not included)	497
Wet 2 pcs. single point fitting for roller carrier			
	829.431	Set Countersunk for 5/16"–1/2" (8–12) glass	149
	829.433	Set Clamping disk for 5/16"–1/2" (8–12) glass (not shown)	181

(S0) Special Order; lead time up to 5 weeks.

DRS Rails,
Channels &
AccessoriesPatch Fittings
& Designer
PivotsOffset
Hung Patch
FittingsHeaders &
AccessoriesClosers &
Hardware

Locksets

Pulls &
HandlesSliding
Systems





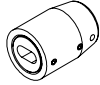
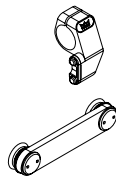
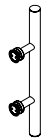
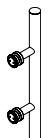
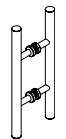



MANET

Panic
Hardware

			Finish \$
Wet Environment Components	Ref. #	U/M Description	700
Wet clamp bracket fitting track to:			(SO)
	829.185	Ea. Glass, countersunk single point fitting for 3/8"-1/2" (10-12) glass	129
	829.186	Ea. Glass, clamping disk single point fitting for 3/8"-1/2" (10-12) glass	147
	829.163	Ea. Wall	107
Wet wall fitting for track			
	829.446	Ea. Round	116
Wet door stop			
	829.427	Ea. Left hand	212
	829.428	Ea. Right hand	212
	829.368	Ea. Connector for 5/16"-1/2" (8-12) glass	127
Wet handle, single side; countersunk for 5/16", 3/8", 1/2" (8/10/12) glass			
	829.269	Ea. Length 13-25/32" (350) 2F	334
	829.272	Ea. Length 28-11/32" (720) 2F	350
	829.275	Ea. Length 48-13/16" (1240) 3F	425
	829.278	Ea. Length 69-5/16" (1760) 4F	550
Wet handle, single side, clamping disk			
	821.280	Ea. Length 13-25/32" (350) 2F	347
	821.281	Ea. Length 28-11/32" (720) 2F	394
	821.282	Ea. Length 48-13/16" (1240) 3F	532
	821.283	Ea. Length 69-5/16" (1760) 4F	690
Wet handle, Back to back			
	821.247	Ea. Length 13-25/32" (350) 2F	509
	821.250	Ea. Length 28-11/32" (720) 2F	607
	821.253	Ea. Length 48-13/16" (1240) 3F	707
	821.256	Ea. Length 69-5/16" (1760) 4F	842

(SO) Special Order; lead time up to 5 weeks.

MANET Wood Door Package Components

	Ref. #	U/M	Description	Finish \$
				700
	829.422	Ea.	Roller Carrier, stainless steel, lug only with roller, includes anti-jump, use with solid track tube (2 required per door panel/ price per roller)	392
	829.423	Ea.	Roller carrier, classic in 316L stainless steel	497
	829.510	Set	Countersunk single point fitting for roller carrier, 15/16" (24) to 1-3/4" (44) door thickness (1 set required per roller carrier)	75
	829.178	Ea.	Clamp bracket for mounting track to wall, 5/8" (16) between track and wall, (See chart on page 224 for quantity of clamps recommended)	129
	829.425	Ea.	Door stop, left hand (1 LH and RH required per door panel)	138
	829.426	Ea.	Door stop, right hand (1 LH and RH required per door panel)	138
	821.527	Ln.	Sliding track tube fixed length, 118" (3000) with end caps	169
				List \$
	807.226	Ea.	Floor guide for 1-3/4" (44) wood door (1 required per sliding door panel)	3
	829.506	Ea.	Connector for sliding track tube (1 required for every 2 ea. 821.527)	55
	821.134	Ea.	Assembly tool, MANET single point fittings (No finish)	24

DRS Rails,
Channels &
AccessoriesPatch Fittings
& Designer
PivotsOffset
Hung Patch
FittingsHeaders &
AccessoriesClosers &
Hardware

Locksets

Pulls &
HandlesSliding
Systems

MANET

Panic
Hardware

Clamp Bracket Reference Chart

Recommended distance of track clamp bracket points for hanging track tube

Door Height	Door Width – 27-1/2" (700)		Door Width – 31-1/2" (800)	
	Glass Thickness		Glass Thickness	
	3/8" (10)	1/2" (12)	3/8" (10)	1/2" (12)
74-13/16" (1900)	13-3/4" (350)	13-3/4" (350)	15-3/4" (400)	15-3/4" (400)
78-3/4" (2000)	13-3/4" (350)	13-3/4" (350)	15-3/4" (400)	15-3/4" (400)
82-11/16" (2100)	13-3/4" (350)	13-3/4" (350)	15-3/4" (400)	15-3/4" (400)
86-1/2" (2200)	13-3/4" (350)	13-3/4" (350)	15-3/4" (400)	15-3/4" (400)
90-9/16" (2300)	13-3/4" (350)	13-3/4" (350)	15-3/4" (400)	15-3/4" (400)
94-1/2" (2400)	13-3/4" (350)	13-3/4" (350)	15-3/4" (400)	15-3/4" (400)
98-7/16" (2500)	13-3/4" (350)	13-3/4" (350)	15-3/4" (400)	15-3/4" (400)
	Door Width – 35-7/16" (900)		Door Width – 39-3/8" (1000)	
	Glass Thickness		Glass Thickness	
	3/8" (10)	1/2" (12)	3/8" (10)	1/2" (12)
74-13/16" (1900)	17-11/16" (450)	17-11/16" (450)	19-11/16" (500)	19-11/16" (500)
78-3/4" (2000)	17-11/16" (450)	17-11/16" (450)	19-11/16" (500)	19-11/16" (500)
82-11/16" (2100)	17-11/16" (450)	17-11/16" (450)	19-11/16" (500)	19-11/16" (500)
86-1/2" (2200)	17-11/16" (450)	17-11/16" (450)	19-11/16" (500)	19-11/16" (500)
90-9/16" (2300)	17-11/16" (450)	17-11/16" (450)	19-11/16" (500)	19-11/16" (500)
94-1/2" (2400)	17-11/16" (450)	17-11/16" (450)	19-11/16" (500)	19-11/16" (500)
98-7/16" (2500)	17-11/16" (450)	17-11/16" (450)	19-11/16" (500)	19-11/16" (500)
	Door Width – 43-5/16" (1,100)		Door Width – 47-1/4" (1,200)	
	Glass Thickness		Glass Thickness	
	3/8" (10)	1/2" (12)	3/8" (10)	1/2" (12)
74-13/16" (1900)	21-3/4" (550)	20-3/4" (530)	21-5/8" (550)	20-1/2" (520)
78-3/4" (2000)	21-1/4" (540)	20-1/16" (510)	21-1/4" (540)	20-1/16" (510)
82-11/16" (2100)	20-3/4" (530)	19-11/16" (500)	20-7/8" (530)	19-11/16" (500)
86-1/2" (2200)	20-1/2" (520)	19-5/16" (490)	20-1/16" (510)	18-7/8" (480)
90-9/16" (2300)	20-1/16" (510)	18-7/8" (480)	19-11/16" (500)	18-1/2" (470)
94-1/2" (2400)	19-11/16" (500)	18-1/2" (470)	19-5/16" (490)	18-1/8" (460)
98-7/16" (2500)	19-5/16" (490)	18-1/8" (460)	18-7/8" (480)	17-11/16" (450)
	Door Width – 51-3/16" (1,300)		Door Width – 55-1/8" (1,400)	
	Glass Thickness		Glass Thickness	
	3/8" (10)	1/2" (12)	3/8" (10)	1/2" (12)
74-13/16" (1900)	21-3/4" (550)	20-1/16" (510)	21-1/4" (540)	20-1/16" (510)
78-3/4" (2000)	20-3/4" (530)	19-11/16" (500)	20-3/4" (530)	19-11/16" (500)
82-11/16" (2100)	20-1/2" (520)	19-5/16" (490)	20-1/2" (520)	19-5/16" (490)
86-1/2" (2200)	20-1/16" (510)	18-7/8" (480)	19-11/16" (500)	18-1/2" (470)
90-9/16" (2300)	19-11/16" (500)	18-1/2" (470)	19-5/16" (490)	18-1/8" (460)
94-1/2" (2400)	19-5/16" (490)	18-1/8" (460)	18-7/8" (480)	—
98-7/16" (2500)	18-7/8" (480)	17-11/16" (450)	18-1/2" (470)	—

Glass Panic Hardware

Order Forms	Glass Push Bar Hardware	226
	Cylinder and Keying	227
Ordering Guides	DG1000/DG1100/DG1300 Series	228
	Keyways	229
Glass Push Bar Hardware	Exterior Fixed Pull Handles	230
	DG1000/DG1100/DG1300 Series Hardware and Options	231
	Keyways and Keying Options	234

- DRS Rails, Channels & Accessories
- Patch Fittings & Designer Pivots
- Offset Hung Patch Fittings
- Headers & Accessories
- Closers & Hardware
- Locksets
- Pulls & Handles
- Sliding Systems
- MANET
- Panic Hardware**

Glass Push Bar Hardware Order Form

**Fax completed form to
(888) 238-4401**

Complete one form for each unit or set of units defined by the same options.

Date: ____ / ____ / ____

Company Name: _____ PO# _____

Contact Name: _____ Tel.# _____

Project Name: _____ City/State: _____

Architect: _____

Unit Type — check one:

- | | | | | | | | |
|---------------------------|---------------------------------|-------------------------------------|----------------------------|-----------------------------|----------------------------|-----------------------------|---------------------------------|
| Panic (P) Bar Type | Top Latch | Bottom Latch Full Length Bar | Exterior Handle: | <input type="checkbox"/> A | <input type="checkbox"/> B | <input type="checkbox"/> C | <input type="checkbox"/> D |
| Dead Bolt (DB) Bar Type | <input type="checkbox"/> DG1000 | <input type="checkbox"/> DG1100 | <input type="checkbox"/> E | <input type="checkbox"/> F | <input type="checkbox"/> G | <input type="checkbox"/> H | <input type="checkbox"/> J |
| Dummy (DM) Bar Type | <input type="checkbox"/> DG1000 | <input type="checkbox"/> DG1100 | <input type="checkbox"/> K | <input type="checkbox"/> KS | <input type="checkbox"/> L | <input type="checkbox"/> LS | <input type="checkbox"/> M |
| | | <input type="checkbox"/> DG1300 | <input type="checkbox"/> N | <input type="checkbox"/> P | <input type="checkbox"/> X | <input type="checkbox"/> Y | <input type="checkbox"/> Z None |
- (See page 234 for descriptions of exterior handles.)

DG1300 only: Top Bolt only (Default) Bottom Bolt only Top and Bottom Bolts

Quantity of Units: _____
Swing: (Refer to Chart)

Single Acting, 3 4
 Single Door: 5 6

Single Acting, 3 & 4
 Pair: 5 & 6

DG1300 Only for Double Acting

Double Acting,
 Single Door: 1 2

Double
 Acting, Pair: 1 & 2

IMPORTANT

Jamb Condition: Sidelites Frame Clear Opening Width: _____
 Wall (Pivot distance must be increased to 3-1/2")

Header Size: 4-1/2" (DB Units only)
 6" (DG1000 P)

NOTE: DG1000 P and DG1100 P available in swing 3, 4 single doors, or 3 & 4 pairs only. Swing 1, 2, 5, 6 in singles or pairs for DB units (DG1000 DB, DG1100 DB, or all DG1300).

- Electric Strike:** 310-1 3/4" Straight Keeper — ES3101 PS610RF Power Supply
- Check one** 12V 24V
 DC AC
 Fail Secure Fail Safe

- Sill Condition:** Floor Mounted Strike
 Threshold Ramp Strike (min. 1/2" x 7")

- DRS Rails:** Square: 2-1/2" 3-5/8" 4" 6" 10"
 Tapered: 2-1/2" 3-5/8" 4"

Door Type:

*F door type for use with DM units only

**Specify stile width

Metal or Wood:
Specify x"
x" = Thickness of metal or wood door.

- Glass/Door Thickness:** 3/8" (9.5 mm) 1/2" (13 mm) 5/8" (16 mm) 3/4" (19 mm)

Actual Door Size: Width: _____ Height: _____ **Push Bar Height from bottom of door:** Specify: _____

- Finish:**
- | | |
|--|---|
| <input type="checkbox"/> Satin Stainless Steel (700/630) | <input type="checkbox"/> Polished Stainless Steel (701/629) |
| <input type="checkbox"/> Satin Brass (599/606) | <input type="checkbox"/> Polished Brass (503/605) |
| <input type="checkbox"/> Dark Oxidized Oil Rubbed Bronze (602/613) | <input type="checkbox"/> Custom: _____ |
| (Special order; quote only) | (Special order; quote only) |

Cylinder and Keying Order Form

Cylinder Type:

- C – SFIC with Core (Default)
- J – SFIC Cylinder with Plastic Temporary Core
- T – SFIC with Temporary Construction Core
- D – Conventional
- 91 – Dummy (Blank Cylinder)
- 92 – Thumbturn Cylinder (Check local codes)

Cylinder Location by Bar Type

- Panic (P): Exterior (Default) Exterior x Dummy (Blank)
- Dead Bolt (DB): Cylinder Exterior x Thumbturn Interior (Default)
 Cylinder Exterior x Cylinder Interior
 Thumbturn Exterior x Thumbturn Interior (Check local codes)

Keyways Options

SFIC:	Less Core	<input type="checkbox"/> 00			
	Best Keyways	<input type="checkbox"/> BA (Default)	<input type="checkbox"/> BB	<input type="checkbox"/> BC	<input type="checkbox"/> BD
		<input type="checkbox"/> BE	<input type="checkbox"/> BF	<input type="checkbox"/> BG	<input type="checkbox"/> BH
		<input type="checkbox"/> BK	<input type="checkbox"/> BL	<input type="checkbox"/> BM	<input type="checkbox"/> BQ
	DORMA	<input type="checkbox"/> D100 (DORMA SKC 7-pin Core only)			
	Temporary Core Colors	<input type="checkbox"/> Black	<input type="checkbox"/> Blue	<input type="checkbox"/> Green	

- Conventional: SC – Schlage C SE – Schlage E D100 – DORMA SKC

Keying Options

SFIC:	<input type="checkbox"/> TMP – Temporary Keying Option – Two Change Keys & One Control Key
	<input type="checkbox"/> MKD – Master Keyed, Keyed Different (Default; specify KA or KD)
	<input type="checkbox"/> UNC – Uncombined (No Pins, Springs, or Keys)
	<input type="checkbox"/> SKD – Keyed Different, Not Master Keyed

- Conventional: KD – Keyed Different (Default) MKD – Master Keyed
 KA2 – Keyed Alike (set of 2) CMK – Construction Master Keyed
 NSK – Non-Stock Keyed Alike 0BIT – 0-Bitted

NOTE: Default SFIC (Small Format Interchangeable Core) cylinder with **C BA** is always shipped installed in device. Other cylinder options require replacement in the field.

- DRS Rails, Channels & Accessories
- Patch Fittings & Designer Pivots
- Offset Hung Patch Fittings
- Headers & Accessories
- Closers & Hardware
- Locksets
- Pulls & Handles
- Sliding Systems
- MANET
- Panic Hardware

DG1000 Series

Ordering Guide

Pull Type

Straight Horizontal	A
90° Up, Short	B
90° Down, Long	C
90° Up, Long	D
90° Down, Short	E
Straight Vertical, Full Length	F
Straight Vertical Centered Short, Radius Top	G
Straight Vertical Centered Short, Radius Bottom	H
Straight Vertical, Center to Top, Radius Bottom	J
Straight Vertical, Center to Top, No Radius	JS
Straight Vertical, Center to Bottom, Radius Top	K
Straight Vertical, Center to Bottom, No Radius	KS
Straight Vertical, 3/4 Length from Top, Radius Bottom	L
Straight Vertical, 3/4 Length from Top, No Radius	LS
Straight Vertical, 3/4 Length from Bottom, Radius Top	M
Straight Vertical, 3/4 Length from Bottom, No Radius	MS
Straight Vertical, Mini, Radius Bottom	N
Straight Vertical, Mini, Radius Top	P
Straight Vertical, Mini, Off Center Up, Radius Top & Bottom	X
Straight Vertical, Mini, Off Center Down, Radius Top & Bottom	Y

Strike

S1	Single Ramp Strike
S2	Double Ramp Strike
S3	Floor Mount Dome Strike - DG1100, 5/8" protection off floor
S4	Threshold Mount Ramp Strike
ES1	Ramp w/ Single Electric Strike
ES2	Ramp w/ Double Electric Strike
ES2-3	Ramp w/ Double Electric Strike - 1 Manual, 1 Electric - Specify door position
S5	Adjustable Eccentric Bushing
S6	1-1/4" Dust Proof Strike
S7	Flat Strike Plate

Swing

6
5
4
3
2
1
5&6
3&4
1&2

Finish

700	Satin Stainless Steel (SS/630)
701	Polished Stainless Steel (PS/629)
503	Polished Brass w/o Laquer (PB)
599	Satin Brass w/o Laquer (SB)
602	Oil Rubbed Bronze (10B/613) ²

See Next Page for Keyway & Keying Options

Shear Lock

NONE
2765

Keyway & Keying Options

Series

DG	1000	PN		D	4				1/2	700		NONE		
-----------	-------------	-----------	--	----------	----------	--	--	--	------------	------------	--	-------------	--	--

Top Bar Only	1000	PN - Panic	TB - Top Bolt Only (default)	Fail Secure - 24VDC	SEDC	A	1/2 - 1/2"	CYLxTT - Cylinder x Thumbturn (Default)
Bottom Bar Only	1100	DB - Dead Bolt	BB - Bottom Bolt Only	Fail Safe - 24VDC	SADC	BP	3/8 - 3/8"	CYLxCYL - Cylinder x Cylinder
Full Length Straight Vertical Bar	1300	DM - Dummy Bar	TBB - Top & Bottom Bolt	Fail Secure, - 24VAC	SEAC	F	5/8 - 5/8"	TTxTT - Thumbturn x Thumbturn ⁴
	Bar Style	Function	Bolt Location (1300 DB Only)	Fail Safe, - 24VAC	SAAC	X³	3/4 - 3/4"	Cylinder Location (1300 DB Only)
					Electric Strike	Door Type	1-3/4 - 1-3/4"	
							>1-3/4 - Specify ¹	
							Glass/Door Thickness	

Keyways

Ordering Guide

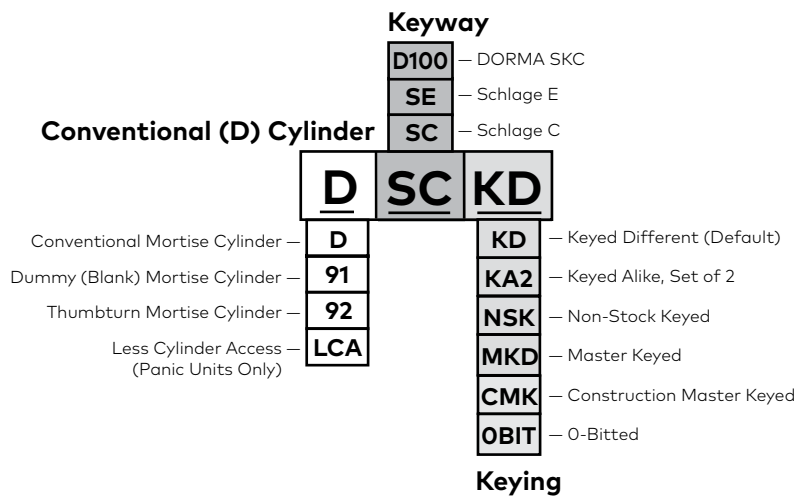
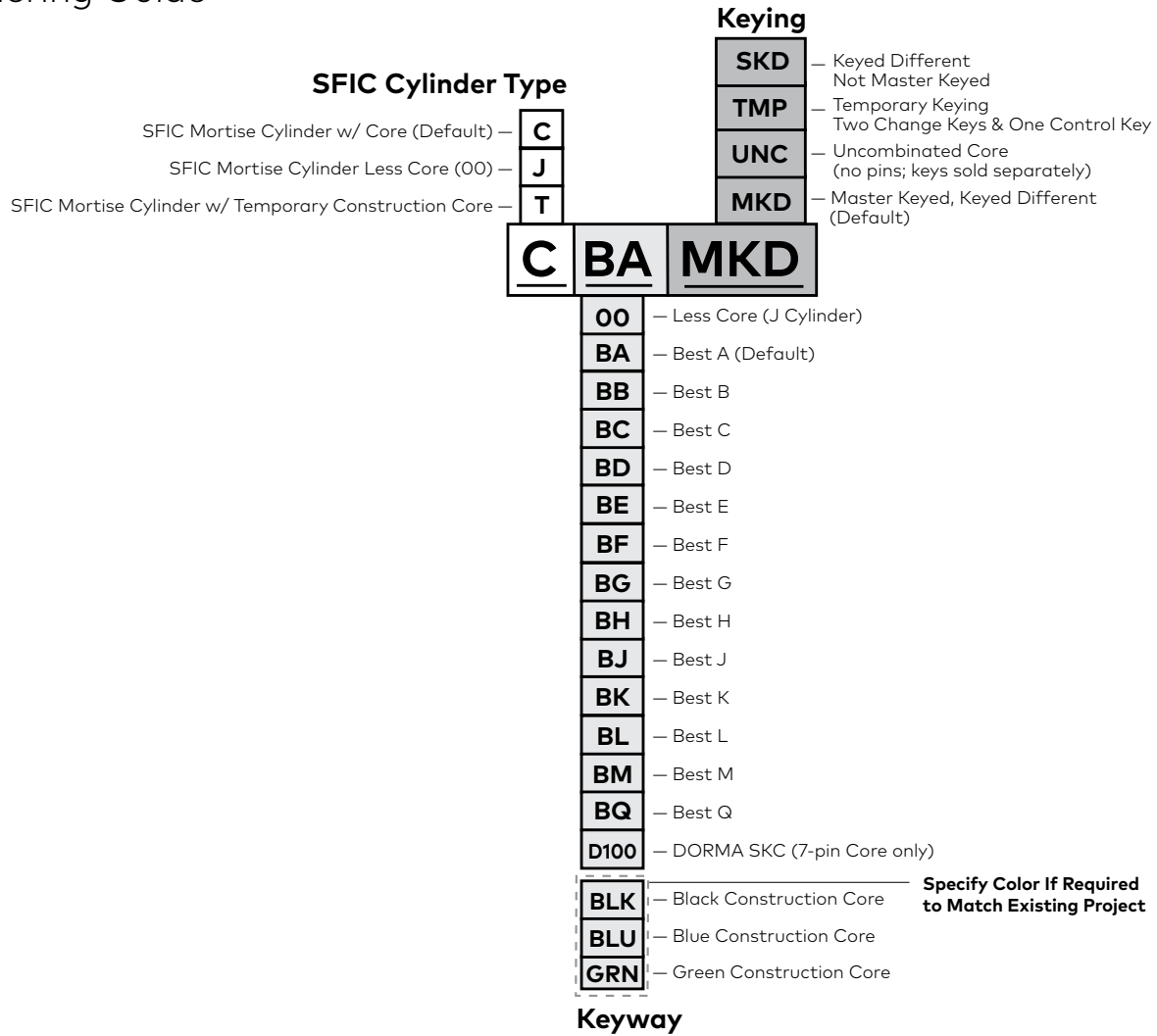

NOTES:

- Allow additional 4-week lead-time for all keying options on D conventional cylinders, SFIC cores for C type cylinder options, and Master Keying.
- See page 238 for other SFIC cylinder list price options.
- Model C SFIC (Small Format Interchangeable Core) cylinder provided as default with BA keyway (includes two change keys and one control key).
- See page 238 for cylinder and core list price Deducts.

- DRS Rails, Channels & Accessories
- Patch Fittings & Designer Pivots
- Offset Hung Patch Fittings
- Headers & Accessories
- Closers & Hardware
- Locksets
- Pulls & Handles
- Sliding Systems
- MANET
- Panic Hardware

Exterior Fixed Hardware Pull Handles

Product Detail

All available handle types are shown below.

NOTE: For reference, the following information appears below each handle type:

- The List Add Price for that handle in Finish 700.
- Symbols for the door types allowed with that handle.

Key to symbols:

- DG1000
- DG1100
- △ DG1300

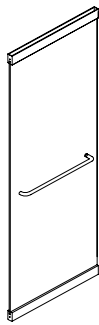

Handle A

468
● ○

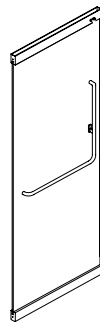

Handle B

1,291
● ○

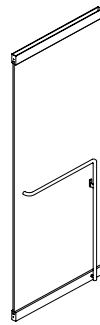

Handle C

1,931 ● ○

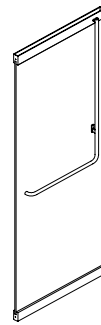

Handle D

1,247
● ○

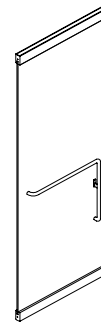

Handle E

1,073
● ○



Handle F

1,806
● ○ △

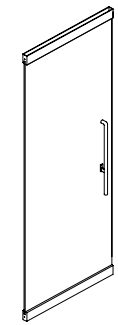

Handle G

1,130
●

List Add \$
(700 finish
shown):
Door Type:

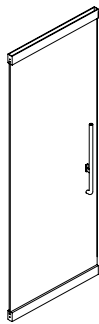

Handle H

1,117
●

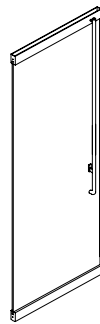

Handle J

1,188
●



Handle JS

1188
●

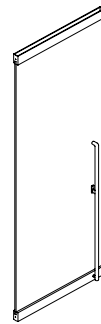

Handle K

1,188
○

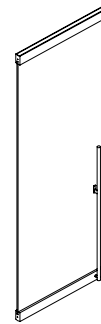

Handle KS

1,188
○



Handle L

1,188
○



Handle LS

1,188
○

List Add \$
(700 finish
shown):
Door Type:

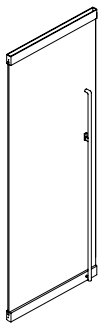

Handle M

1,188
●

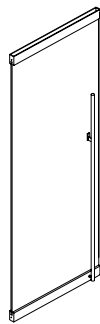

Handle MS

1,188
●

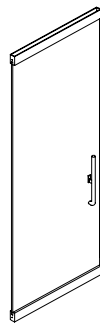

Handle N

1,028
○

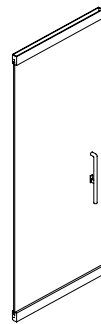

Handle P

1,028
● ○

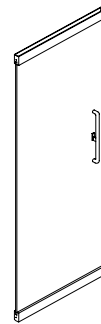

Handle X

1,028
● ○

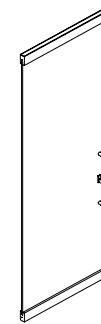

Handle Y

1,028
● ○

List Add \$
(700 finish
shown):
Door Type:

DG1000/DG1100/DG1300 Series

Hardware and Options

Product Configuration	Ref. #	Description	Finishes \$			
			700	701	599	503
			(20)	(20)	(20)	(20)
DG1000P	970.100	Top bar only, latching panic, no pull	4,012	4,573	5,053	5,844
DG1000DB	970.210	Top bar only, dead bolt, no pull	4,185	4,482	4,996	5,842
DG1000DM	970.310	Dummy, non-latching top bar only, no pull	1,469	1,582	1,610	1,673
DG1100P	970.110	Bottom bar only, latching panic, no pull	4,361	4,943	5,338	6,125
DG1100DB	970.211	Bottom bar only, dead bolt, no pull	4,561	5,170	5,300	6,147
DG1100DM	970.311	Dummy, non-latching bottom bar only, no pull	1,469	1,582	1,610	1,673
DG1300DB	970.213	Dead bolt, full length vertical bar, no pull (Specify Top only [default], Bottom only, or Top/Bottom bolt)	4,561	5,169	5,300	6,169
DG1300DM	970.313	Dummy, full length vertical bar, no bolt, no pull	1,513	1,616	1,649	1,848
Pull Handle Options			List Add \$			
A	970.401	A style pull	468	544	640	887
B	970.402	B style pull	1,291	1,366	1,463	1,709
C	970.403	C style pull	1,931	2,010	2,110	2,353
D	970.404	D style pull	1,247	1,394	1,494	1,737
E	970.405	E style pull	1,073	1,168	1,315	1,562
F	970.406	F style pull	1,806	1,877	1,969	2,196
G	970.407	G style pull	1,130	1,230	1,374	1,619
H	970.408	H style pull	1,117	1,212	1,360	1,606
J	970.409	J style pull	1,188	1,271	1,419	1,665
JS	970.410	JS style pull	1,188	1,271	1,419	1,665
K	970.411	K style pull	1,188	1,271	1,419	1,665
KS	970.412	KS style pull	1,188	1,271	1,419	1,665
L	970.413	L style pull	1,188	1,271	1,419	1,665
LS	970.414	LS style pull	1,188	1,271	1,419	1,665
M	970.415	M style pull	1,188	1,271	1,419	1,665
MS	970.416	MS style pull	1,188	1,271	1,419	1,665
N	970.417	N style pull	1,028	1,127	1,419	1,665
P	970.418	P style pull	1,028	1,127	1,419	1,665
X	970.419	X style pull	1,028	1,127	1,419	1,665
Y	970.420	Y style pull	1,028	1,127	1,419	1,665
Z	—	No pull	—	—	—	—

(20) Custom Fabricated; lead time up to 20 business days.

NOTES:

- Manual or electric strikes not included in base price.
- Allow up to an additional 4 weeks lead time for 602 or other non-standard finishes, fabrication, or configurations.

DRS Rails, Channels & Accessories
Patch Fittings & Designer Pivots
Offset Hung Patch Fittings
Headers & Accessories
Closers & Hardware
Locksets
Pulls & Handles
Sliding Systems
MANET
Panic Hardware

DG1000/DG1100/DG1300 Series

Hardware and Options Continued

Product Configuration	Ref. #	Description	Finishes \$			
			700	701	599	503
			(20)	(20)	(20)	(20)
Options			List Add \$			
S1	970.598	Ramp strike for DG1000, single door	198	198	219	223
S2	970.599	Ramp strike for DG1000, double door	322	322	536	579
ES1	ES1	Single ramp plus 1 each ES3101 Electric Strike for DG1000, single door	1,485	1,482	1,469	1,466
ES2	ES2	Double ramp plus 2 each ES3101 Electric Strikes for DG1000, double door	2,727	2,754	2,716	2,707
ES2-3	ES2-3	Double ramp plus 1 each Manual Strike and 1 each ES3101 Electric Strike for DG1000, double door	2,495	2,490	2,486	2,470
S3	970.593	Floor mounted dome strike for DG1100, 5/8" (16mm) projection off floor	109	—	—	—
S4	970.592	Threshold mounted strike for DG1100 (ADA)	202	—	—	—
S5	805.194	Eccentric bushing, adjustable center for DB units	54	—	—	—
S6	932.033	Dust-proof strike, 1-1/4" (32 mm) length	30	30	30	30
S7	925.140	Flat strike plate	15	15	15	15
FIT5875	970.582	Fitting pack for 5/8" (16 mm) or 3/4" (19 mm) thick glass	90	90	90	90
FIT175	970.583	Fitting pack for 1-3/4" (44 mm) thick wood or aluminum door	90	90	90	90
FIT>175	970.584	Fitting pack for greater than 1-3/4" (44 mm) thick wood or aluminum door (Verify desired door thickness with Technical Service.)	162	162	162	162
Panic Accessories						
ES1.C	970.499	Ramp Assembly Component for Electric Strike (Less Electric Strike)	310	313	327	331
ES2.C	970.500	Double Ramp Assembly Component for Pair of Electric Strikes (Less Electric Strike)	411	417	427	434
ES3101_SE_DC	970.506	FA 310-1 24VDC Fail Secure	1,018	—	—	—
ES3101_SA_DC	970.505	FA 310-1 24VDC Fail Safe	1,018	—	—	—
ES3101_SE_AC	970.502	FA 310-1 24VAC Fail Secure	1,018	—	—	—
ES3101_SA_AC	970.501	FA 310-1 24VAC Fail Safe	1,018	—	—	—
EMSL2765	933.025	2700 LB Shear Lock	1,277	—	—	—
EMSL2765SC	925.846	2700 LB Semi-Concealed	1,277	—	—	—
						101
EML-371	925.811	Single Magnetic Lock, 750 lb (340 kg)				360
EML-371 BA DP	925.812	Single Magnetic Lock, 750 lb (340 kg) with bond sensor and door position switch				487
EML-372	925.810	Double Magnetic Lock, 750 lb (340 kg)				721
EML-372 BA DP	925.813	Double Magnetic Lock, 750 lb (340 kg) with bond sensor and door position switch				973
						List \$
PS610RF		Power Supply, 1.0 A @ 24 VDC filter/reg, class 2 selectable output, fire panel interface standard				427

(20) Custom Fabricated; lead time up to 20 business days.

Product Configuration	Ref. #	Description	Finishes \$						
			101	108	700	701	599	503	714
			(20)	(20)	(20)	(20)	(20)	(20)	(20)
			List Add \$						
HSTOP	233.989	Header stop for single or pairs of doors (top latching panic only)	23	23	52	52	52	52	69
3118	970.790	Armored flex conduit, 18" (457 mm)	36	53	—	—	—	—	59
3218	970.790	Heavy-Duty armored flex conduit, 18" (457 mm) with J-box	—	—	70	—	—	—	—

(20) Custom Fabricated; lead time up to 20 business days.

- DRS Rails, Channels & Accessories
- Patch Fittings & Designer Pivots
- Offset Hung Patch Fittings
- Headers & Accessories
- Closers & Hardware
- Locksets
- Pulls & Handles
- Sliding Systems
- MANET
- Panic Hardware



DG1000/DG1100/DG1300 Series

Keyways and Keying Options

Model	SFIC (Small Format Interchangeable Core) Cylinder Options	All Standard Finishes [†]	
	SFIC Cylinder Type Description	List Deduct \$	
C	SFIC — Housing with combined SFIC construction core installed at the factory; BA (default), BB, BC, BD, BE, BF, BG, BH, BJ, BK, BL, BM, BQ, D100 keyway — Keys sold separately	NC	
MKD	Masterkeyed, Keyed Different (Keyed different to a random combination) or Keyed Alike; BA Core with 1 control key and 2 change keys; Up to 20 days additional lead time for Keyed Alike — Keys included	NC	
T	SFIC — Housing with keyed temporary SFIC construction core (Core may be returned for a full refund)	Deduct 5	
J	SFIC — Housing with disposable plastic SFIC plug	Deduct 45	
	SFIC "C" Core/Keyway Description	List Deduct \$	
00	Less Core	Deduct 45	
BA	Best A (default)	NC	
BB	Best B	NC	
BC	Best C	NC	
BD	Best D	NC	
BE	Best E	NC	
BF	Best F	NC	
BG	Best G	NC	
BH	Best H	NC	
BJ	Best J	NC	
BK	Best K	NC	
BL	Best L	NC	
BM	Best M	NC	
BQ	Best Q	NC	
D100	DORMA Patented 7 Pin	NC	
	SFIC "T" Core/Keyway Description	List Deduct \$	
BLK	Black Temporary Core	Deduct 5	
BLU	Blue Temporary Core	Deduct 5	
GRN	Green Temporary Core	Deduct 5	
	SFIC Keying Description	List Deduct \$	Lead Time
UNC	Uncombined (core with no pins; keys sold separately)	Deduct 45	20 Days

NOTE: Cylinder options other than **C BA** will be shipped loose to be replaced in the field..

[†] Standard finishes: 503 (605), 599 (606), 700 (630), and 701 (629).

Model	Conventional Cylinder Options with Panic or Dead Bolt Bars	All Standard Finishes [†]	Additional
Cylinder Description		List Deduct \$	Lead Time
D SC	Conventional Cylinder with Schlage C Keyway	Deduct 45	None
D SE	Conventional Cylinder with Schlage E Keyway	Deduct 45	20 Days
D D100	Conventional Cylinder with DORMA Patented Keyway	Deduct 45	20 Days
91	**Dummy (Blank) Mortise Cylinder (in lieu of D)	Deduct 45	None
92	**Thumbturn Mortise Cylinder (in lieu of D)	Deduct 31	None
Conventional Cylinder Keying Description			
KD	Keyed differently to a random combination; SC keyway with 2 keys (default)	Deduct 45	None
KA2	Keyed Alike in pairs to a random combination; SC keyway with 2 keys	Deduct 45	20 Days
NSK	Keyed Alike (or Keyed to Order - KTO) quantities other than KA2; SC keyway with 2 keys	Deduct 35	20 Days
MKD	Master keyed; SC, SE, or D100 keyway —  Keys sold separately	Deduct 29	20 Days
CMK	Construction master keyed single cylinder locks —  Keys sold separately	Deduct 27	20 Days
0-Bit	Operated by a key blank; AA, CA, CB, CC, CD, CE, RA, RB, GA, SF, WA, YA, YG keyways with 2 keys	Deduct 33	20 Days

NOTE: Cylinder options other than **C BA** will be shipped loose to be replaced in the field.

** For Model 91 or 92, check local codes.

[†] Standard finishes: 503 (605), 599 (606), 700 (630), and 701 (629).

dormakaba USA, Inc.
Tel: 800-523-8483
Fax: 800-274-9724
www.dormakaba.us
glassorders.us@dormakaba.com