

# OWNER'S MANUAL



## FAR INFRARED SAUNAS

Please read this manual before using your sauna for the first time.

Please keep this manual for future reference.



## Congratulations on your purchase!

Your new Vortex™ Infrared Sauna is an excellent investment in your health and wellbeing. You can now enjoy all the benefits of a sauna session – in the comfort and privacy of your own home.

Please note, this is the starting point for information about your new sauna. As you read through this document you'll see links and QR codes you can scan with your device, which will lead you to the complete User Guide.

The User Guide contains all the information you need to assemble, install, use and maintain your new sauna. It applies to all Vortex™ Linear and Prestige sauna models.

The User Guide is a digital-only document. As an environmentally-conscious, carbon-neutral company – we're making all our full user manuals digital-only.

Now we've covered the basics... are you ready for some relaxation and rejuvenation? Great, let's get started!

---

# Important safety information

Your safety is paramount. Please read the following safety information carefully before you begin assembling your new sauna.

## Health and safety warning

Infrared saunas and sauna heaters can pose serious dangers and health risks, including, without limitation, risks of burns to your body, fires, and serious health complications from inappropriate use or over-exposure, up to and including death. Users should consult their doctor prior to use. Do not use an infrared sauna if you are pregnant, trying to conceive, are under the influence of drugs or alcohol, live with a medical device that is sensitive to heat, or have hemophilia.

## Fire warning

Heaters are located in sauna walls and under most sauna benches. All sauna heaters (and not just the glowing near-infrared heaters) can cause a fire if covered or even partly obstructed. DO NOT leave pillows or other objects leaning up against any of the heaters.

## Electronics

Heat can also cause damage to electronics such as smartphones, media tablets, and laptop computers. Any use of the foregoing in a sauna is at the sole risk of the user.



---

## Before you start assembling your sauna...

As a general rule, it takes two people around 3 hours to assemble this sauna. Before you start, you'll want to make sure you have enough time and extra help available. Also, when deciding where to put your sauna – check you have a power socket nearby to plug it into.

For your safety and convenience please:

- Wear protective shoes and glasses
- Keep children away from the assembly process
- Ensure you have two people assisting with the installation
- Allow 2-3 hours for installation

## Choosing a location

1. Place your sauna inside on a dry and level surface for the best results. **An unlevel surface will make it so that the sauna cannot be assembled correctly.**
2. The ambient room temperature of your selected location will directly affect your sauna room temperature.
3. During a 30-minute sauna session, the sauna air temperature will reach between 46-51 degrees depending on the starting ambient room temperature. Your sauna heater panels will get to 65 degrees but the ambient sauna temperature will not.

## Installation requirements

1. Your Vortex sauna is a self-contained and freestanding unit. Your sauna will not be covered under warranty if it is built into a structure.
2. Please maintain a minimum of 8cm clearance on all sides of the unit to allow air to circulate while giving access for the power cord.



# Table of Contents

This manual covers the Vortex™ Linear and Prestige models. While the installation process for these two models is similar, there are some key differences to be aware of which we note in the manual.

## Linear™ and Prestige™ Models

<b>Packaging contents</b> .....	<b>3</b>
Contents of boxes .....	3
Accessory box contents .....	3
<b>Installation video</b> .....	<b>4</b>
<b>Assembly instructions</b> .....	<b>5</b>
<b>Location of sauna and installation order</b> .....	<b>5</b>
1. Placing floor panel .....	5
2. Placing back panel .....	5
3. Connecting side walls .....	6
4. Installing floor molding .....	7
5. Installing under bench support .....	8
6. Connect heater connection under bench .....	9
7. Installing the bench .....	10
8. Installing the roof panel .....	11
9. Installing the side and front wall glass .....	12

## Linear™ Models

10. Installing the door, front and side glass for Linear™ Models only .....	13
Right front wall glass .....	13

## Prestige™ Models

10. Installing the door, front and side glass for Prestige™ Models only	14
Right front wall glass .....	14
Completed glass installation (Prestige™ Models only) .....	15
11. Installing the front element heaters (Prestige™ Models only) .....	16
12. Installing roof brackets .....	17
13. Connect heaters in roof .....	18
14. Installing door handle .....	19
Installation Complete .....	20

## Linear™ Models

Using your sauna control panel (Linear™ Models) .....	21
---	----

## Prestige™ Models

Using your sauna control panel (Prestige™ Models only) .....	23
Cleaning and maintenance .....	25
Warranty information .....	25
Safety accreditations .....	25

# Packaging contents

## CONTENTS OF BOXES

### Box 1 of 3

1. Floor panel
2. Ceiling panel
3. Bench
4. Bench support

### Box 2 of 3

1. Left side panel
2. Right side panel

### Box 3 of 3

1. Front wall
2. Back wall
3. Accessories
4. Installation manual

## ACCESSORY BOX CONTENTS

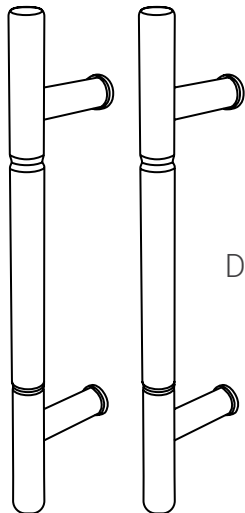

Door Handles

1. Corner Strip x 2
2. Single magnetic strip x 2
3. Handles x 2



# Installation video

Click the play button to watch the video.



Scan QR code to watch the video.



[qrs.ly/lpd6v48](https://qrs.ly/lpd6v48)

# Assembly instructions

Two adults are required to assemble this sauna. Please read the instructions thoroughly before and during assembly to ensure proper installation of the unit.

## LOCATION OF SAUNA & INSTALLATION ORDER

When determining a location for your sauna, please keep in mind the following:

- a. The main power cord on the sauna must be easily accessible.
- b. The location must be dry and level. Note: During installation, if the base is not level gaps may appear. In this instance you may need to add packers under the base of your sauna.
- c. Panels should be installed in the following order:

- |                             |                            |                                 |
|-----------------------------|----------------------------|---------------------------------|
| 1) Floor                    | 6) Heater connection       | 11) Front element heaters       |
| 2) Back panel               | 7) Bench                   | 12) Roof brackets               |
| 3) Left and right side wall | 8) Roof panel              | 13) Roof and heaters connection |
| 4) Floor molding            | 9) Side & front wall glass | 14) Door handle                 |
| 5) Under bench support      | 10) Front wall glass       | 15) Power cord                  |

### 1. - PLACING FLOOR PANEL

Place the bottom floor panel on the ground near the location you will be using the sauna. Make sure the front of the floor is in the desired location of the door.

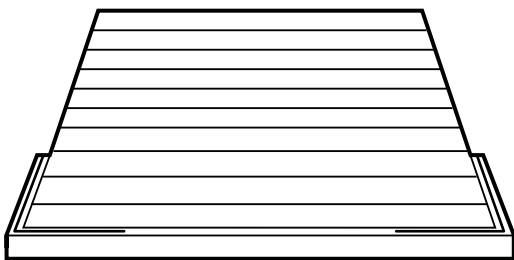

### 2. - PLACING BACK PANEL

Place the back panel on the floor panel by lining up the back panel on the groove of the floor panel.

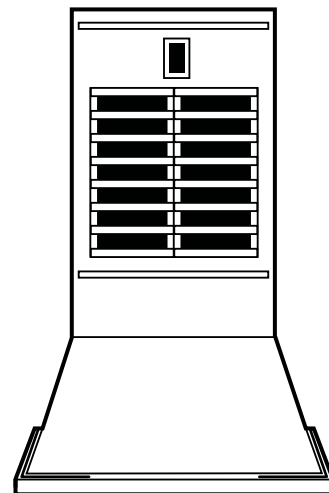

### 3. - CONNECTING SIDE WALLS

The side wall panels will be connected to the back wall by connecting together the installed brackets. There are “+” brackets and “-” brackets on the side of each panel. The side walls will be installed as follows:

1. Place the left side wall in the slot in the floor. Lift the side wall up about 10cm higher than the backwall panel (See Picture 1).
2. Place the side wall panel against the back wall (See Picture 2), then slide down side wall panel until the two panels are equal height. (See Picture 3).
3. If the panels are not equal height or there is an obvious gap between the two panels, this means they are not properly attached and you should try again.
4. Repeat the steps above for the right side wall panel.

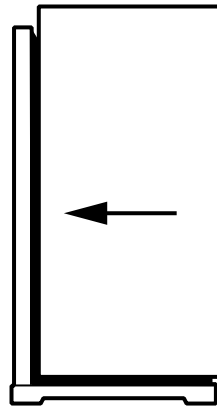

Picture 1

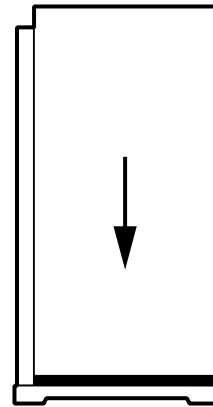

Picture 2

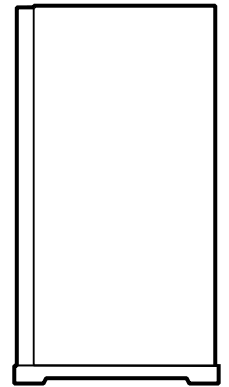

Picture 3



If the panels still seem too tight to come down all the way, try backing off the bracket screws by one half turn with a Phillips head screwdriver on the female bracket.

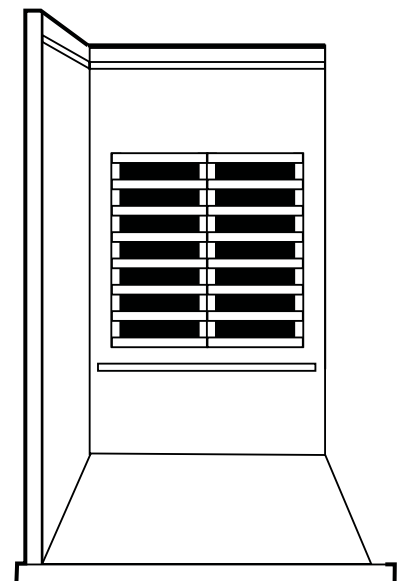
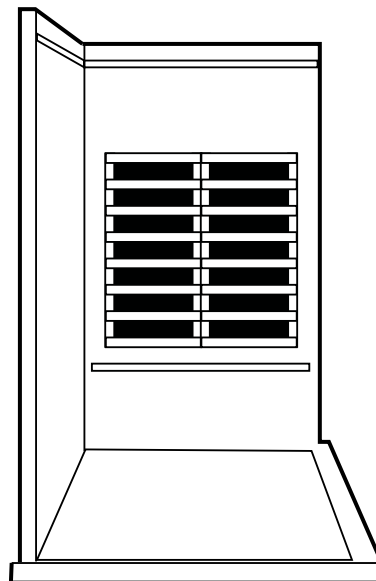



#### 4. - INSTALLING FLOOR MOLDING

1. Locate the two short and one long floor molding pieces.
2. Using a Phillips head screwdriver, screw in the floor molding pieces.
3. The short pieces are screwed in along the left and right side wall pieces. The long piece is screwed in along the back.



Left side wall



Screw long piece along back side wall

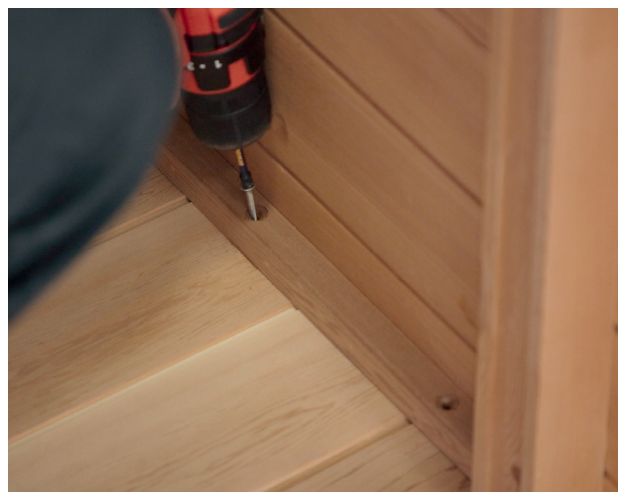

Right side wall

5. - INSTALLING UNDER-BENCH SUPPORT

Slide down the bench heater panel by lining up its sides with the vertical guides on the left and right side wall panel.

1. Be careful not to scratch the side panels when positioning the heater panel.
2. Push the bench heater panel all the way down until it is touching the floor panel and is securely in place.



▼ Vertical bench heater panel guides are found on the side panels



▶ Heater must be facing outward

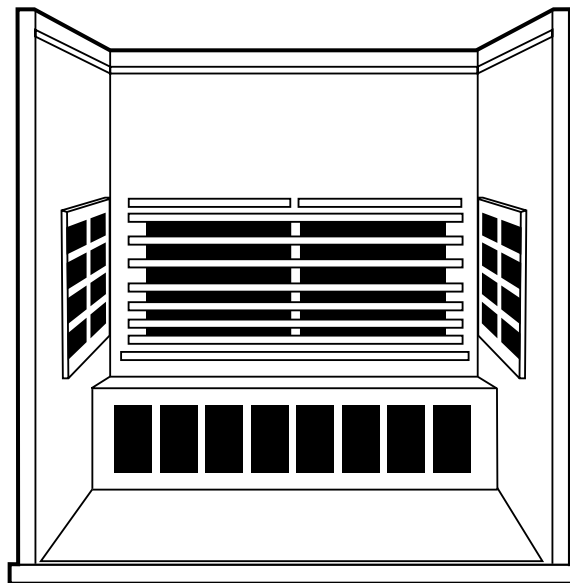



## 6.- CONNECT HEATER CONNECTION UNDER BENCH

Follow the connections as in the following illustration:

1. Connect the black and white cable coming out of the back of the under bench support to one of the left side wall connectors.
2. Connect the side black and white wall cable to one of the floor connectors.
3. Connect the black and white back wall cable to the other floor connector.
4. Connect the green ground connectors together.



You can plug any male connector to any female one as long as the colours match.



Left side wall connectors



Top view

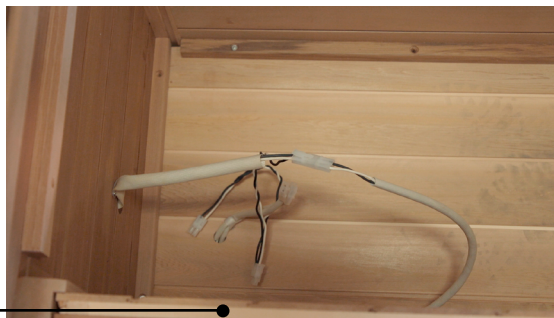

Under bench back.





## 7. - INSTALLING THE BENCH

Install the bench by sliding it over the horizontal bench guides on the side panels. Be careful not to scratch the adjacent panels when sliding in the bench.

Push the bench all the way in until it touches the back panel and is securely in place. The bench is reversible. One side is ergonomic and one side is flat.

You can reverse the bench after the sauna installation is finished. Be sure that the bench is pushed all the way back until it slides under the heater guard to secure the bench in place.

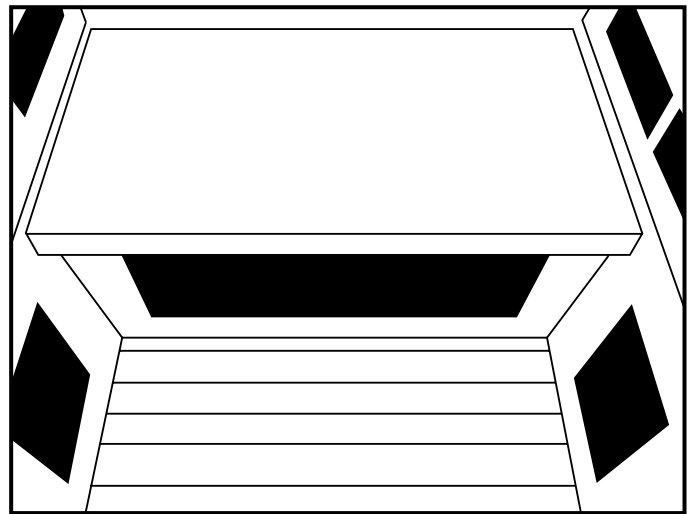

## 8. - INSTALLING THE ROOF PANEL

1. Lower the roof panel on to the assembled panels.
2. Position the top panel so that the exterior lights are at the front of the sauna.
3. Make sure that the cables from the top panel do not get pinched when placing the panel.
4. Gently place the top panel onto the rest of the assembled panels. When all four corners are in place, gently push down the roof panel from the outside corners until it fits snugly over the rest of the panels.

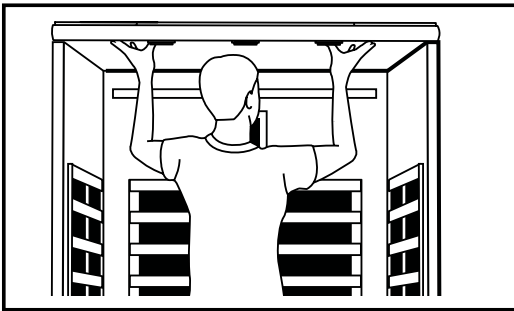

Do not fix the top to the sides with the screws at this time.

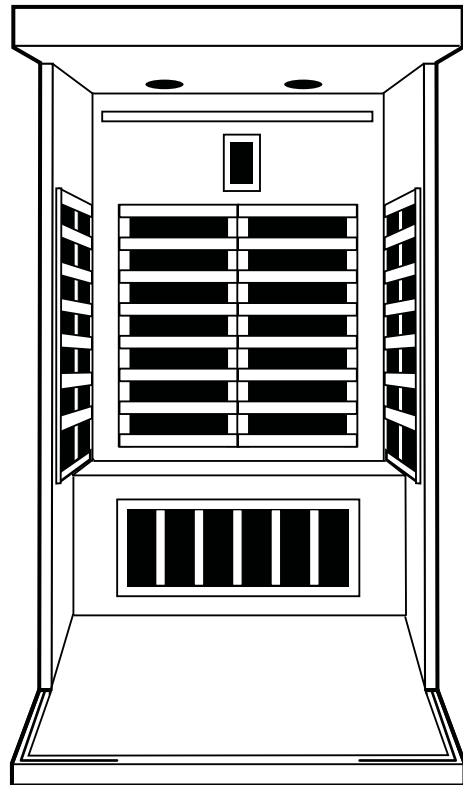

## 9. - INSTALLING THE SIDE AND FRONT WALL GLASS

1. Locate the left side and the left front wall glass.
2. Before placing in the slot, push on the corner plastic strip so that the side glass and the front glass connect - leave 50mm at the top and bottom.
3. Lift and slide glass panels into the corner slot.
5. Push on the single plastic strip on the right side of the front wall glass.

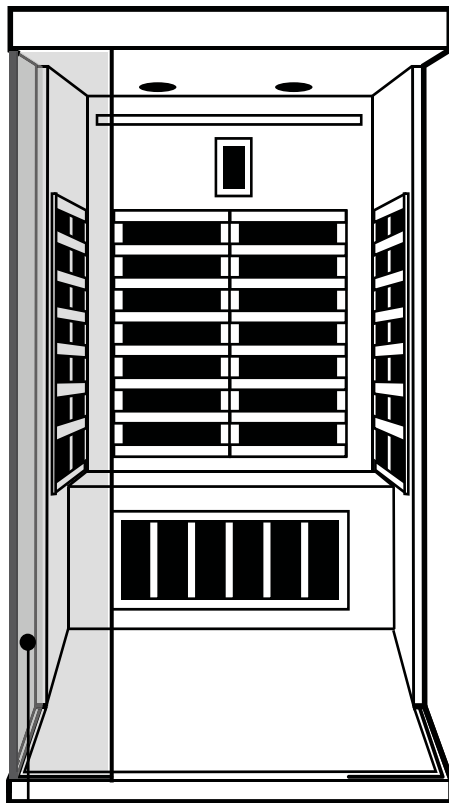

Left side glass

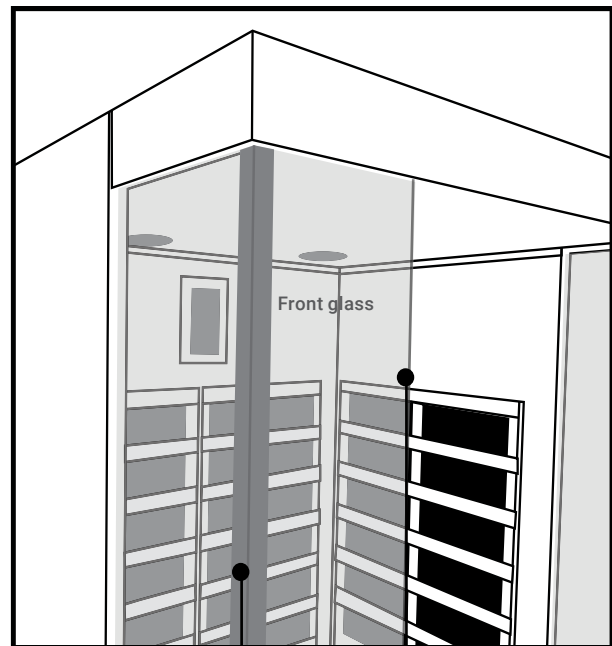

Single strip

Corner plastic strip



## 10. - INSTALLING THE DOOR, FRONT AND SIDE GLASS FOR LINEAR™ MODELS ONLY

---

### Right front wall glass

1. Locate the the door, right front wall glass and right side wall glass.
2. Before placing in the slot, push on the corner plastic strip so that the side glass and the front glass connect - leave 50mm at the top and bottom.
3. Push on the single plastic magnetic strip to the left side of the door glass - leave 50mm at the top and bottom.
4. Slide glass panels into the slot on the floor. Be sure to have two people assisting with the glass.
5. Lift up the roof at the front right corner about 50mm, align the glass panels under the slot in the roof and then push the roof down on the glass.



Please be careful when carrying and installing the glass pieces to avoid breakage. Make sure the glass is securely fastened during installation before letting go of any individual piece that could break.

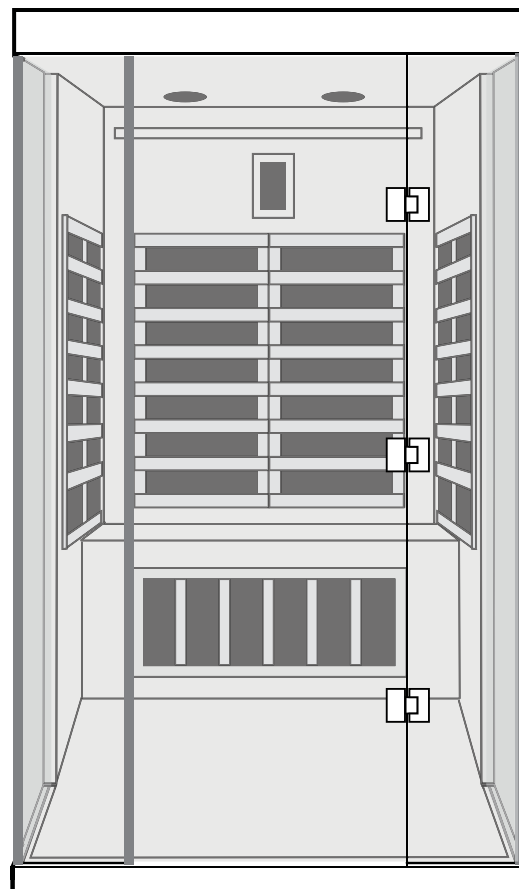

## 10. - INSTALLING THE FRONT AND SIDE WALL GLASS PRESTIGE™ MODELS ONLY

---

### Right front and side wall glass

1. The front and side glass panels have pre-drilled holes for the heater element. The holes are off-center.
2. Align the two glass panels to meet on the corners with the shortest distance from the hole to glass edge.
3. Locate the door, right front wall glass and right side wall glass.
4. Before placing in the slot, push on the corner plastic strip so that the side glass and the front glass connect - leave 50mm at the top and bottom.
5. Push on the single plastic magnetic strip to the left side of the door glass - leave 50mm at the top and bottom.
6. Slide glass panels into the slot on the floor. Be sure to have someone hold the door while you lift the glass into the slot.
7. Lift up the roof at the front right corner about 50mm, align the glass panels under the slot in the roof and then push the roof down on the glass.
8. Repeat these steps for the left side.



Please be careful when carrying and installing the glass pieces to avoid breakage. Make sure the glass is securely fastened during installation before letting go of any individual piece that could break.

- COMPLETED GLASS INSTALLATION (PRESTIGE<sup>™</sup> MODELS ONLY)

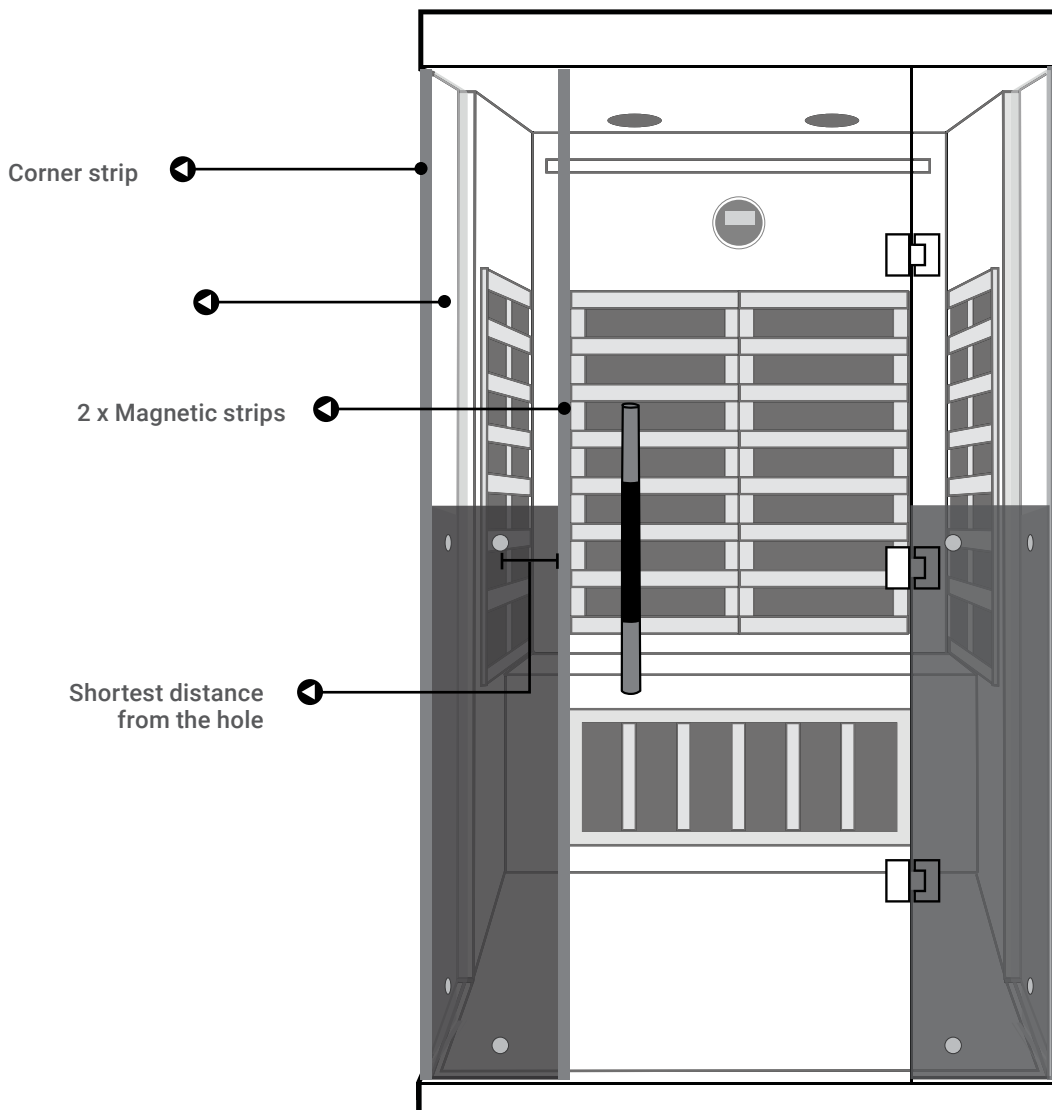

## 11. - INSTALLING THE FRONT ELEMENT HEATERS

1. Fit mounting brackets to the top and the bottom of the front heaters.
2. Before attaching to the glass, attach front panel power cable to sauna base cable.
3. Line up the brackets with the holes in the glass and push into place.
4. From the outside, screw in four screws connecting the glass panel to the front heater bracket.
5. Repeat steps for opposite side.



Fit mounting brackets



Attach front panel power cable to sauna base cable



Insert screws into the glass panel through the front heater bracket

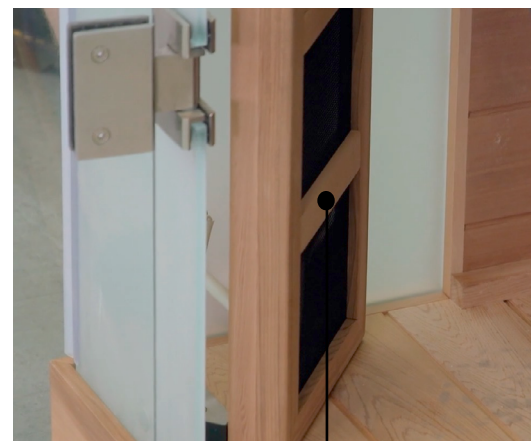

Element heater



## 12. - INSTALLING ROOF BRACKETS

1. Locate the three double eye roof brackets and 6 screws.
2. Install the first double eye roof bracket in the top of the roof above where the left side glass meets the left side wood wall by screwing it in to join the two sections.

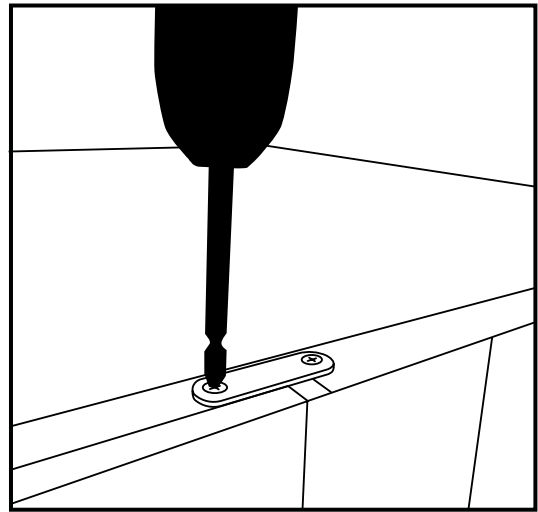
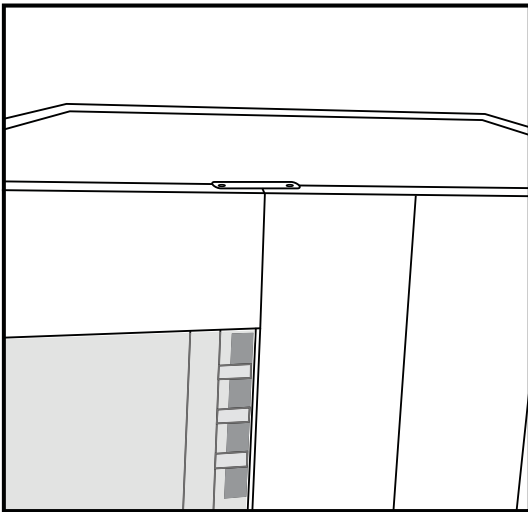

3. Repeat this for the right side.
4. The third double eye bracket connects the back wall to the roof cover.
5. Align the bracket in the centre of the back wall and screw in one side to the top of the back wall section and the other side to the roof dust cover.

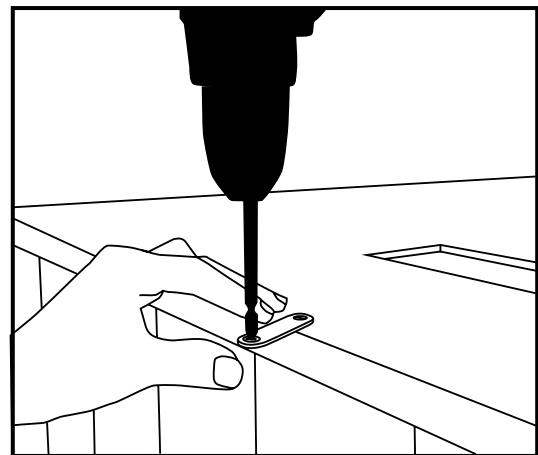

### 13. - CONNECT HEATERS IN ROOF

1. Locate the “trap” doors that open in the roof.
2. Connect the black and white cables that come out of the walls to the connector located in the roof.
3. Connect the green ground wire that comes out of the walls to the green ground wire that is in the roof. Push the wiring inside the roof area and close the roof door compartments.
4. In the left side wall compartment, there will be two connectors: 1) Heater connector. 2) Keypad connector. The heater connector is a two wire connector. The keypad connector is a seven wire connector.

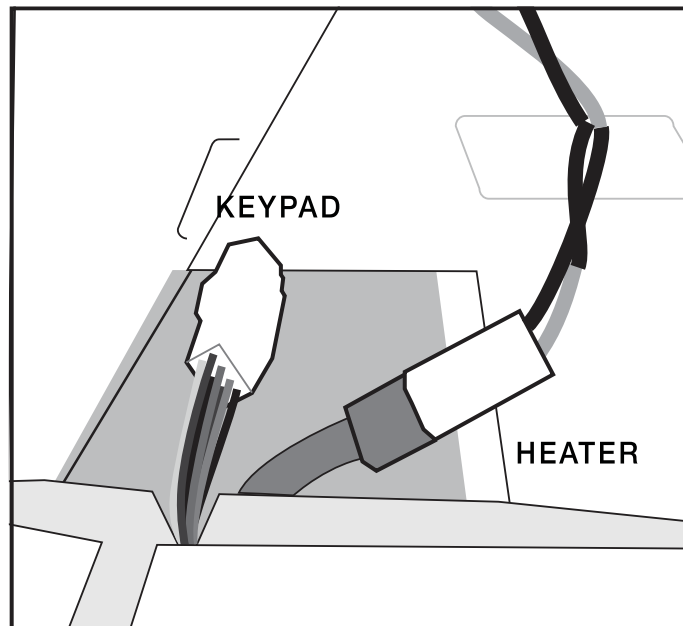

Be sure to match the colours in the connectors.  
The black wire should match up with the black wire, etc.

#### 14. - INSTALLING DOOR HANDLE

---

1. Locate one side of the handle.
2. Place the plastic spacer on the inside and the outside.
3. Attach the inside handle. Be careful not to overtighten the screw as this may damage the glass.
4. Attach the outside handle. This will slide over the connecting lugs.
5. Tighten the screws with the allen key.



#### 15. - LOCATING AND PLUGGING IN POWER CORD

---

The power cord comes out of the roof of the sauna. If you are standing facing the sauna, it comes out of the rear left corner of the roof. Open the trap door to access the power cord and run the cord down the back of the sauna. The power cord will plug into the appropriate electrical receptacle.



**Note:** We do not recommend using an extension cord for your sauna. Please plug the sauna directly into the wall receptacle.

---

- INSTALLATION IS COMPLETE

---

Installation of your sauna is now complete. Using a damp cloth, wipe out the sauna to remove any excess. Sawdust that may have settled on the wall and floor panels and the heater panels.

Please refer to usage instructions located later on in this manual.

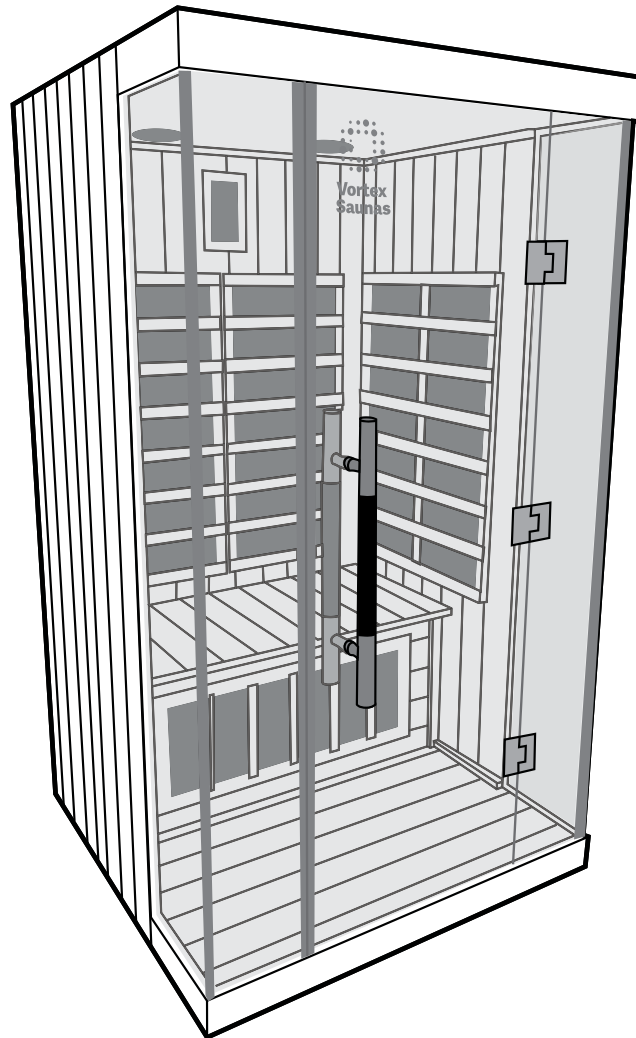



# Using your sauna control panel

Unlike a traditional sauna, infrared heats the body directly. Air temperature in the sauna is not as important as the type and quality of the infrared being received. We recommend the following protocol:

- a. Turn the sauna on for 10 minutes to allow the heaters to begin heating up, and for the cabin to warm to a comfortable temperature.
- b. When you enter the sauna, set the time to the desired session time and turn the thermostat up to 150°F / 65°C. This will ensure the heaters are on the entire time. During a 30 minute sauna session, the sauna air temperature will reach between 115-125°F / 46-51°C depending on the starting ambient room temperature. Please note: Your sauna heater panels will get to 65 degrees but the ambient sauna temperature will not.
- c. Sit back and relax. Enjoy your sauna session.

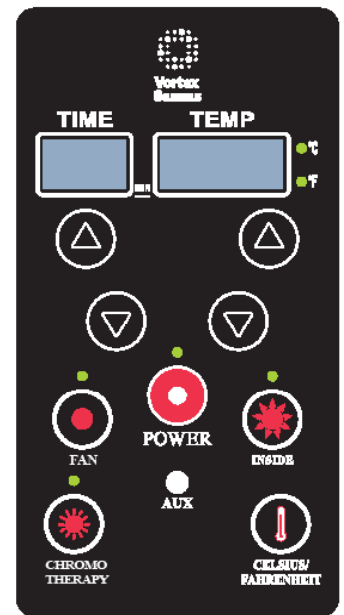

## System On/Off

- 1) Press the “POWER” button once to turn on the sauna.
- 2) Your session will automatically end after the programmed timer expires.
- 3) Press the “POWER” button at any time to turn the sauna off.

## Sauna session time

You can set the duration of your sauna session for a maximum of 60 minutes. Press the TIME UP or TIME DOWN arrows to increase or decrease your desired sauna session time in 5 minute increments. When you have reached your desired time, release the button.

## Controlling the set temperature

You can program your sauna for a maximum temperature of 65°C. Press the TEMP UP/DOWN arrows to set the desired temperature. When the display shows your desired temperature, release the buttons. Press either the TEMP UP or TEMP DOWN buttons during your sauna session to manually control the desired cabin temperature.

# Using your sauna control panel

## Inside light

Press the button labelled “INSIDE” to turn on or off the Interior light.

## Audio system

Your Vortex sauna is equipped with stereo speakers that can be accessed by Bluetooth.

Your Vortex sauna is Bluetooth ready. To connect audio via Bluetooth:

- 1) Open your Bluetooth enabled phone, tablet or computer and search for surrounding Bluetooth devices to find a device called Infrared Sauna. The pairing code for this device is 0000.

## Chromotherapy

The chromotherapy light is controlled by pressing the COLOUR button on the keypad.

Pressing the button once will activate auto mode automatically cycling between colours changing every 8 seconds.

You can also manually change the colours:

1. Press the “Colour” button 2 times to change to GREEN.
2. Press the “Colour” button 3 times to change to RED.
3. Press the “Colour” button 4 times to change to BLUE.
4. Press the “Colour” button 5 times to change to YELLOW.
5. Press the “Colour” button 6 times to change to INDIGO.
6. Press the “Colour” button 7 times to change to VIOLET.
7. Press the “Colour” button 8 times to turn off the Chromotherapy.

# Using your sauna control panel

Unlike a traditional sauna, infrared heats the body directly. Air temperature in the sauna is not as important as the type and quality of the infrared being received. We recommend the following protocol:

- a. Turn the sauna on for 10 minutes to allow the heaters to begin heating up, and for the cabin to warm to a comfortable temperature.
- b. When you enter the sauna, set the time to the desired session time and turn the thermostat up to 150°F / 65°C. This will ensure the heaters are on the entire time. During a 30 minute sauna session, the sauna air temperature will reach between 115-125°F / 46-51°C depending on the starting ambient room temperature. Please note: Your sauna heater panels will get to 65 degrees but the ambient sauna temperature will not.
- c. Sit back and relax. Enjoy your sauna session.

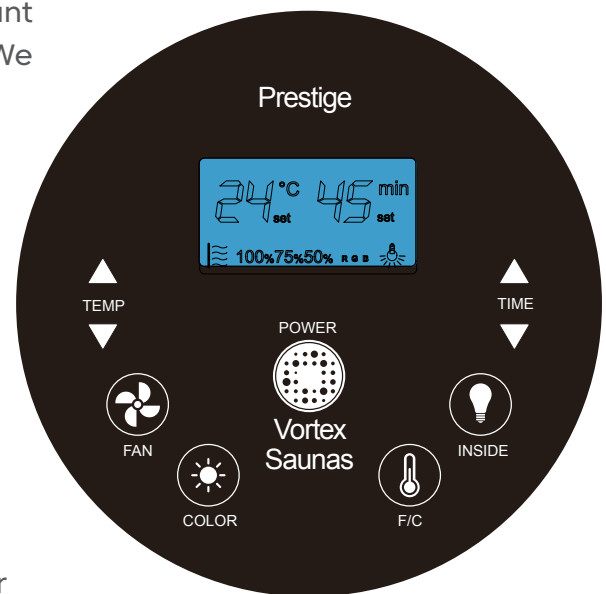

## System On/Off

- 1) Press the “POWER” button once to turn on the sauna.
- 2) Your session will automatically end after the programmed timer expires.
- 3) Press the “POWER” button at any time turn the sauna off.



## Sauna session time

You can set the duration of your sauna session for a maximum of 60 minutes.

Press the TIME UP or TIME DOWN arrows to increase or decrease your desired sauna session time in 5 minute increments.

When you have reached your desired time, release the button.

## Controlling the set temperature

You can program your sauna for a maximum temperature of 65°C. Press the TEMP UP/DOWN arrows to set the desired temperature. When the display shows your desired temperature, release the buttons. Press either the TEMP UP or TEMP DOWN buttons during your sauna session to manually control the desired cabin temperature.

# Using your sauna control panel

## Inside light

Press the button labelled “INSIDE” to turn on or off the Interior light.

## Audio system

Your Vortex sauna is equipped with stereo speakers that can be accessed by Bluetooth.

Your Vortex sauna is Bluetooth ready. To connect audio via Bluetooth:

- 1) Open your Bluetooth enabled phone, tablet or computer and search for surrounding Bluetooth devices to find a device called Infrared Sauna. The pairing code for this device is 0000.

## Chromotherapy

The chromotherapy light is controlled by pressing the COLOUR button on the keypad.

Pressing the button once will activate auto mode automatically cycling between colours changing every 8 seconds.

You can also manually change the colours:

1. Press the “Colour” button 2 times to change to GREEN.
2. Press the “Colour” button 3 times to change to RED.
3. Press the “Colour” button 4 times to change to BLUE.
4. Press the “Colour” button 5 times to change to YELLOW.
5. Press the “Colour” button 6 times to change to INDIGO.
6. Press the “Colour” button 7 times to change to VIOLET.
7. Press the “Colour” button 8 times to turn off the Chromotherapy.



---

## Cleaning and maintenance

1. Before using your sauna for the first time, clean the inside of the sauna with a damp cloth. Use your favourite furniture polish on the exterior.
2. Place a towel on the floor and bench to absorb any perspiration. Wash these often to maintain a clean and pleasant environment inside your sauna.
3. Perspiration may darken the wood over time. This can be removed by a light sanding with fine grit sandpaper.

## Warranty information

Your sauna is covered by a comprehensive warranty. Please note, the warranty applies to indoor, residential sauna use only.

Your warranty includes:

- Lifetime sauna cabin warranty
- Lifetime infrared heaters warranty
- 2-year factory-installed components warranty

## Safety accreditations

We take the safety of our customers very seriously. Our saunas are certified by SAA Approvals Pty Ltd in accordance with the SAA Approvals Electrical Product Safety Certification Scheme accredited by JAS-ANZ under AS/NZS ISO/IEC 17065 and RECS.



