

# Neon™

## — Technical Information Pack



**Vortex™**  
**Spas**

Available exclusively at *Spa* WORLD

# Neon™



JETS

51



WATER CAPACITY

746 litres



SEATING

3 seats



DIMENSIONS

2.06 x 1.69 x 0.82m



## FEATURES

### Build

- Superior USA made Aristech™ acrylic
- Thermobond™ 4 layer shell construction
- 9 shell/cabinet colour combinations
- Duraflex™ 'no kink' PVC plumbing
- Aromatherapy
- Thermoclad™ maintenance-free cabinet

### Water care

- Purezone™ micro filtration
- Purezone™ Ozone water clarifier

### Lighting

- Hydroglow™ underwater LED floodlight

### Control

- SpaNet™ premium control systems
- Spa Health indicator

### Hydrotherapy

- Hydrotherapy lounger
- Individual seat pressure controls
- Volcano jet

### Upgrades included in Avanté pack

- PermaFrame™ timber-free construction
- Purezone™ UV-C sanitiser
- ThermoLock™ Dual layer insulation
- Hydroflow™ stainless steel bearing-less jets
- Hydroglow™ LED backlit water cascade
- Hydroglow™ jet & topside control lighting
- Hydroglow™ programmable lighting
- Hydroglow™ perimeter & cabinet lighting
- Hydroglow™ backlit drink holders
- Hydroglow™ backlit laminar jets

### Optional extras

- SmartLINK™ Wifi connectivity
- SmartSTREAM™ sound system
- SpaNet™ Hybrid heat pump
- Neck therapy collar

## WARRANTIES

Frame .....	Lifetime
Shell structure.....	10 yrs
Acrylic surface .....	5 yrs
Jets, plumbing & heater .....	5 yrs
Pumps & equipment .....	2 yrs

\* Conditions apply. Specifications may change without notice. Pictures may show options not available on all models.

# Neon™

## Jet specifications

---

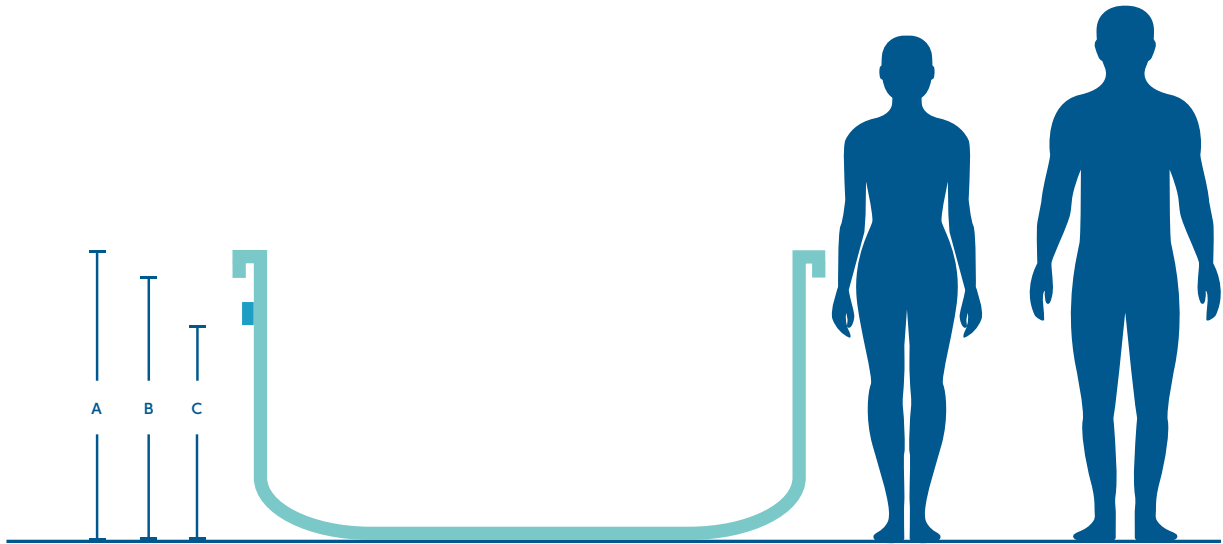

Illustration shows Neon™ spa model

		Neon™
Model dimensions		2.06(L) x 1.69(W)m
A	Total height +/-20mm	0.82m
B	Product height under lip +/-20mm	725mm
C	Height to bottom of health light +/-25mm	520mm

\* Conditions apply. Specifications may change without notice. Pictures may show options not available on all models.

# Neon™

## Jet specifications

Dimensions: 2.06 x 1.69 x 0.82m

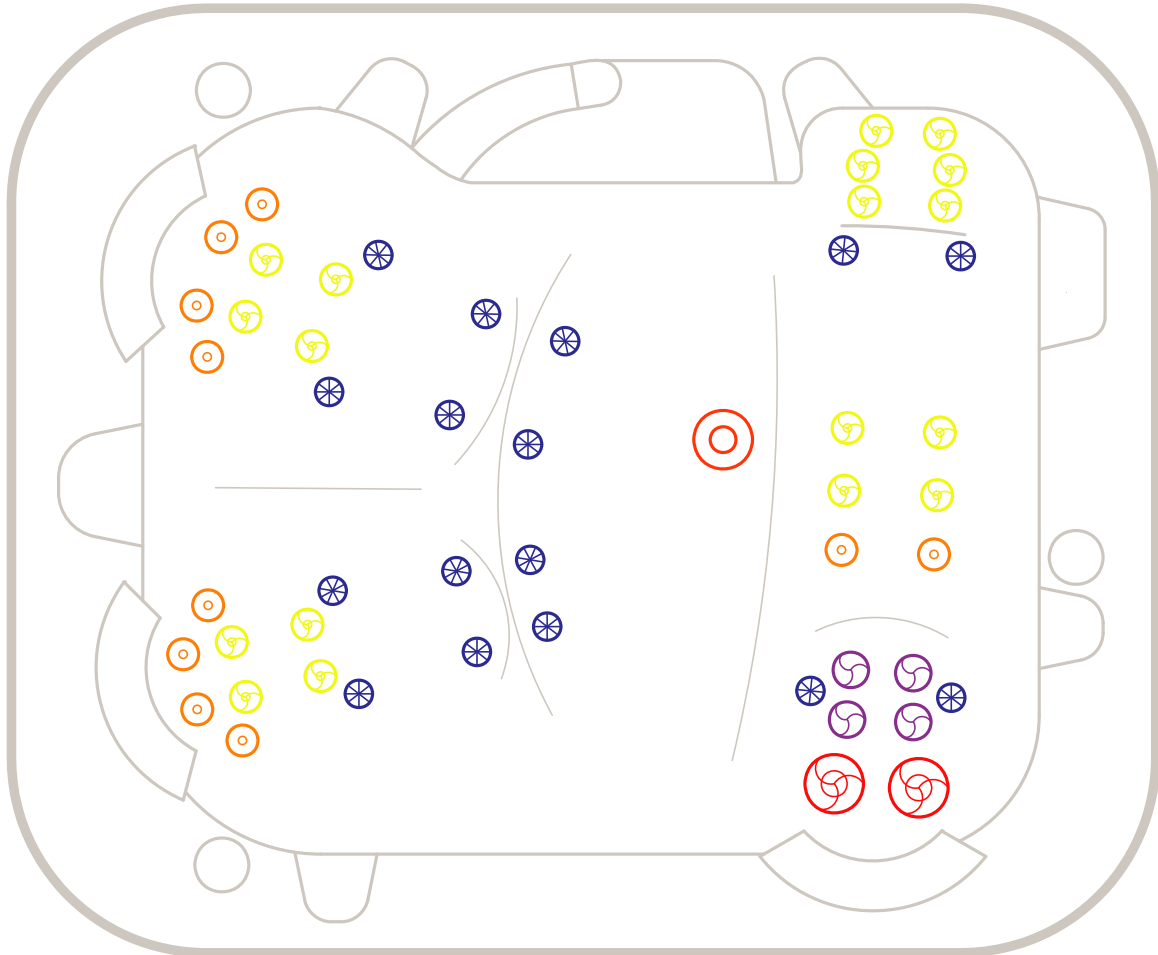

 127mm Single Spinning Jets

 130mm Hi Volcano Directional Jet

 75mm Single Spinning Jets

 50mm Twin Spinner Jets

 40mm Air Jets

 50mm Directional Jets

\* Conditions apply. Specifications may change without notice. Pictures may show options not available on all models.

# Neon™

## Specifications table

<b>Water capacity</b>	746L
<b>Dry weight</b>	265kg
<b>Filled weight (incl cover)</b>	1021kg
<b>Lift weight</b>	352.1kg**
<b>Intuitive spa controller</b>	SV2
<b>Programmable circulation pump</b>	1
<b>Jet pumps</b>	1
<b>Variable speed air blower</b>	1
<b>Variable output heater</b>	3kW max
<b>Recommended electrical supply</b>	15 amps

\*\* The specified Lift weights in the table above include the spa's dry weight, packaging, and hard cover. These are approximate weights and are intended as a guide only. All weights must be checked by the crane operator prior to the lift. (Cranes have the ability to check the weight)

\* Conditions apply. Specifications may change without notice. Pictures may show options not available on all models.

# Neon™

## Equipment location

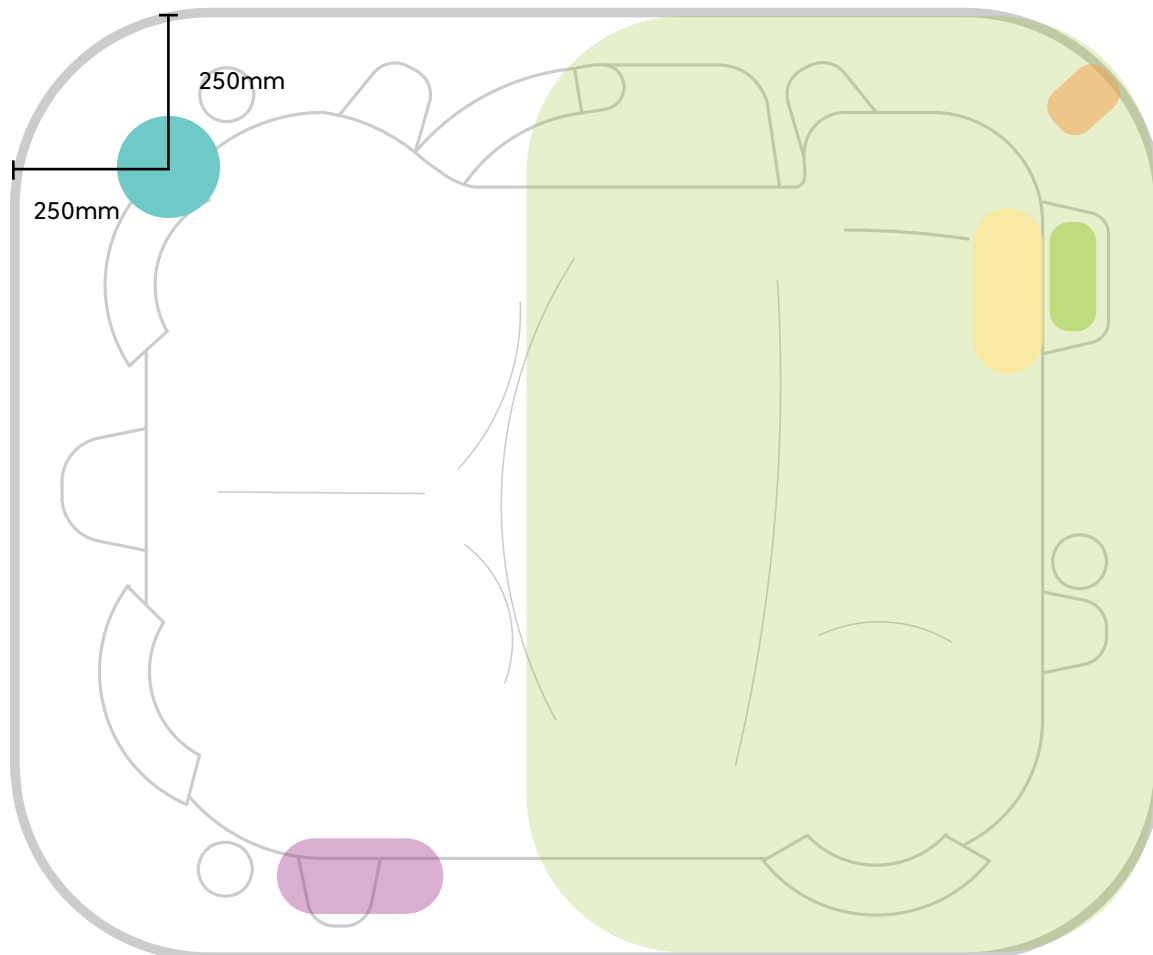







Illustration shows Neon™ spa pool model

	Equipment Bay		Drain Valve		Circulation Pump
	Keypad		Conduit Access		Jet Pump

\* Conduit access should be no more than 100mm high above the concrete slab.

Note: This model has a rigid base, and if you choose to bring the piping conduit in from the bottom through the base, you will need to cut a hole into the base on-site before installation. The factory does not provide this hole. Please see the diagram above to find the location where you can drill the hole.

# Neon™

## Standard Spa Cover

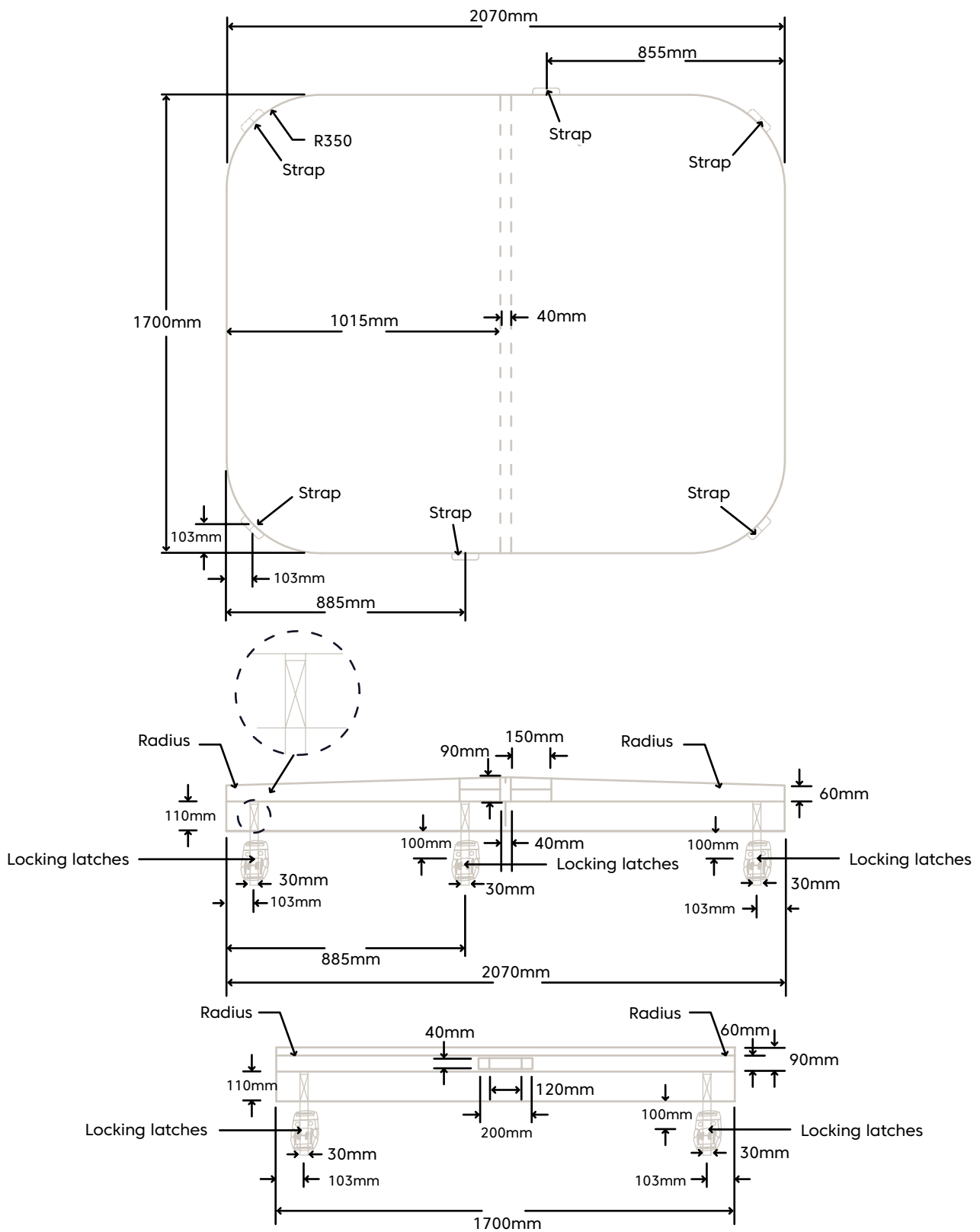

# Neon™

## Planning details

---

Please visit the Spa World website for planning information including:

Property access

Electrical Information

Service access

Foundations, including generic slab

Pit and deck installation

Optional heat pump installation

Use your Smartphone to scan the QR code for your country:

Australia  
[spaworld.com.au](http://spaworld.com.au)



[Click here to find out more](#)

New Zealand  
[spaworld.co.nz](http://spaworld.co.nz)



[Click here to find out more](#)



# Vortex Spas™ Limited Warranty

Vortex Leisure Pty Ltd owns the Vortex Spas™ brand

## Lifetime Warranty on Permaframe™ Frames

Vortex Leisure Pty Ltd warrants the structural integrity of the spa frame against defects in workmanship and materials for the lifetime of the spa subject to the limitations, conditions and exclusions expressed in this warranty.

## 10 year non pro rata structural warranty

Vortex Leisure Pty Ltd warrants the structure of the spa shell against defects in workmanship and materials leading to water loss from the spa for a period of 10 years from date of manufacture subject to the limitations and conditions expressed in this warranty.

## 5 year acrylic warranty

Vortex Leisure Pty Ltd warrants against the loss of water through the acrylic surface of the spa shell for a period of 5 years from date of manufacture, subject to limitations and conditions in this warranty.

## 5 year jet warranty

Vortex Leisure Pty Ltd warrants the removable spa jets to be free of manufacturing defects for a period of 5 years from date of manufacture. This warranty excludes damage by grit, sand and improper water chemistry causing corrosion of the part and is limited to supply of replacement parts after the faulty part has been returned to Vortex Leisure Pty Ltd for warranty inspection. Leaking from jets is covered by the plumbing warranty. Laminar jets have a 1 year parts only warranty.

## 5 year heater warranty

Vortex Leisure Pty Ltd warrants the heater element against defects in materials and workmanship for a period of 5 years from date of manufacture. After 1 year this warranty is limited to the supply of replacement parts and excludes labour and freight costs. This warranty does not cover damage to heaters caused by incorrect water balance resulting in the heater being subjected to abrasive/acid water.

## 5 year plumbing warranty

Vortex Leisure Pty Ltd warrants the plumbing piping and plumbing joints against defects in materials and workmanship causing leaking for a period of 5 years from date of manufacture. After 1 year this warranty is limited to the supply of replacement parts and excludes all labor and freight costs.

## 2 year pump warranty

Vortex Leisure Pty Ltd warrants the water pumps against defects in materials and workmanship for a period of 2 years from date of manufacture. After 1 year this warranty is limited to the supply of replacement parts and excludes all labour and freight costs. Damage to the pump motor caused by incorrect chemical balance will not be covered under this warranty. Vortex Leisure Pty Ltd reserves the right to request that the pump be returned for assessment before it is replaced under this warranty.

## 2 year electronic components warranty

Vortex Leisure Pty Ltd warrants electronic control systems against defects in materials and workmanship for a period of 2 years from date of manufacture. After 1 year the warranty is limited to the supply of replacement parts after the product has been assessed by either Vortex Leisure Pty Ltd or the relevant control system manufacturer.

## 1 year air blower warranty

Vortex Leisure Pty Ltd warrants the air blower against defects in materials and workmanship for a period of 1 year. This warranty will become void if the blower damage is caused by overfilling.

## 1 year thermoclad cabinet warranty

Vortex Leisure Pty Ltd warrants the thermoclad spa cabinet against defects in materials and workmanship for a period of 1 year from date of manufacture. This warranty specifically covers the structural integrity of the cabinet. The thermoclad cabinet finish is warranted to be free from defects in materials and workmanship at the time of initial delivery. Fading and weathering of the surface will occur naturally over time, and are not considered defects.

## 1 year Wifi, audio system, ozone, UV, LED light(s) warranty

Vortex Leisure Pty Ltd warrants the factory installed Wifi, audio system, UV sanitiser, Ozone sanitiser and LED Light(s) assemblies, to be free from defects in materials and workmanship for 1 year. The UV globe is a parts only warranty, if it fails within the 1 year period, a replacement globe will be sent out free of charge to be installed by the customer.

## 1 year external heat pump warranty

Vortex Leisure Pty Ltd warrants the External Heat Pump to be free from defects in materials and workmanship for 1 year. Installation is to be carried out by a qualified contractor. Failure to do so will immediately VOID this warranty. Vortex Leisure Pty Ltd reserves the right to request the return of the heat pump for assessment before it is replaced or repaired.

## 1 year spa hardcover warranty

Your Spa Cover is warranted for a period of 1 Year from the date of delivery. This warranty applies only to the structural integrity of the cover and the vinyl. Damage caused to stitching, straps or locks due to improper use of the cover will not be covered under warranty. Disposal of any cover replaced under warranty will be the owners responsibility.

## Warranty coverage

Warranty coverage begins at the delivery date. Vortex Leisure Pty Ltd only extends this warranty to the original purchaser and only if the spa has been purchased through an authorized Vortex Leisure Pty Ltd reseller. Written notice of the defect and proof of purchase must be provided to Vortex Leisure Pty Ltd or it's nominated representative within 14 days of the defect occurring. If the spa is required to be returned to Vortex Leisure Pty Ltd for rectification all freight costs shall be pre paid by the customer. Repair or replacement of any defective product is at the sole discretion of Vortex Leisure Pty Ltd. To action warranty service contact the authorized Vortex Leisure Pty Ltd reseller you purchased from. If you are unable to obtain satisfactory service from your reseller, written notification must be provided to Vortex Leisure Pty Ltd within 14 days of the defect occurring. Vortex Leisure Pty Ltd will pay the travel costs of the service agent for the first 50km from their base. Any further travel charges shall be the responsibility of the spa owner.

## Electrical connection

All electrical connections must be carried out by a qualified electrical contractor. Failure to do so will immediately VOID this warranty. The spa must be connected to a dedicated MAINS electrical supply circuit protected by a compliant earth leakage circuit breaker safety switch. Vortex Leisure Pty Ltd reserves the right to ask for proof that the spa has been installed by a qualified electrician.

## Warranty exclusions

1. Damage resulting from improper water maintenance.
2. Damage from operating the spa above 45°C.
3. Damage caused by clogged filters
4. Damage caused to the spa by improper use of spa cover and excessive exposure to sunlight.
5. Acts of God.
6. Damage caused by not installing spa on sufficient hard level surface.
7. Damage caused by incorrect electrical installation, brownouts, voltage spikes or operating spa out of +/- 10% of voltage range.
8. Warranty is not extended to filter cartridges, head rests, pump seals or drain hoses.
9. Commercial use reduces all warranties to maximum 6 months.
10. Damage caused by relocation of the spa from its original installed location.
11. Damage by termites, borer or other pests.
12. Damage caused by flooding
13. Damage caused by third party carriers.
14. Damage or corrosion to frame caused by un-repaired leaks or improper drainage.

## Limitations

This warranty is the only warranty offered by Vortex Leisure Pty Ltd and excludes any other implied or oral undertakings. Except as described above, this warranty does not cover defects or damage due to normal wear and tear, improper installation, alteration without Vortex Leisure Pty Ltd's prior written consent, accident, acts of God, misuse, abuse, commercial or industrial use, use of an accessory not approved by Vortex Leisure Pty Ltd, failure to follow Vortex Spas™ Pre-Delivery Instructions or Owner's Manual, or repairs made or attempted by anyone other than an authorized representative of Vortex Leisure Pty Ltd. Vortex Leisure Pty Ltd or its agents will not be liable for any incidental or consequential loss or injury. Vortex Leisure Pty Ltd will not be liable for costs associated with but not limited to building alterations, removal costs, delivery costs or labour costs associated with the replacement of a spa.

You must check and tighten all barrel unions regularly. Failure to do so may affect your warranty.  
See your user manual for further information.

VSW030821



# Vortex Neon<sup>TM</sup>

## Plumbing Approval



**Building Act 1993**  
*Section 238(1)(a)*  
**Building Regulations 2018**  
*Regulation 126*

**CERTIFICATE OF COMPLIANCE FOR PROPOSED BUILDING WORK**

**This certificate is issued to:**

To relevant building surveyor

**This certificate is issued in relation to the proposed building work at:**

Non-site-specific design for Vortex Neon Spa plumbing

**Nature of proposed building work:**

Construction of spa plumbing

**Building classification as per NCC 2019**

N/A

**Prescribed class of building work for which this certificate is issued:**

Design or part of the design of building work relating to this water recirculation matter

**Documents setting out the design that is certified by this certificate:**

Document no.	Document date	Type of document (e.g. drawings, computations, specifications, calculations etc.)	Number of pages	Prepared by
2203283	30/03/2022	Drawings	1	Barrason's Engineers
30P-14-0137-TRP-353298-0-Outlet Cover CMP 25201	29/08/2014	Performance Test	4	VIPAC Plumbing Products Laboratory

**The design certified by this certificate complies with the following provisions of Building Act 1993, Building Regulations 2018 or National Construction Code**

Act, Regulation or NCC	Section, Regulation, Part, Performance Requirement or other provision
NCC 2019 Volume 2	AS 1926.3-2010 Swimming Pool Safety Part 3: Water recirculation systems



I prepared the design, or part of the design, set out in the documents listed above.

I certify that the design set out in the documents listed above complies with the provisions set out above.

I believe that I hold the required skills, experience and knowledge to issue this certificate and can demonstrate this if requested to do so.

**Engineer:**

**Name:** Andrew Barraclough

**E-mail:** admin@barrasons.com.au

**Business licensing authority registration number:**

**Registrations:** FIEAUST, CPEng, NER, RBP

**Qualifications:** BEng MEng PhD

PE0000600

RPEQ 22822

Signed:

Date of issue of certificate: 30/03/2022

# VORTEX NEON SPA PLUMBING

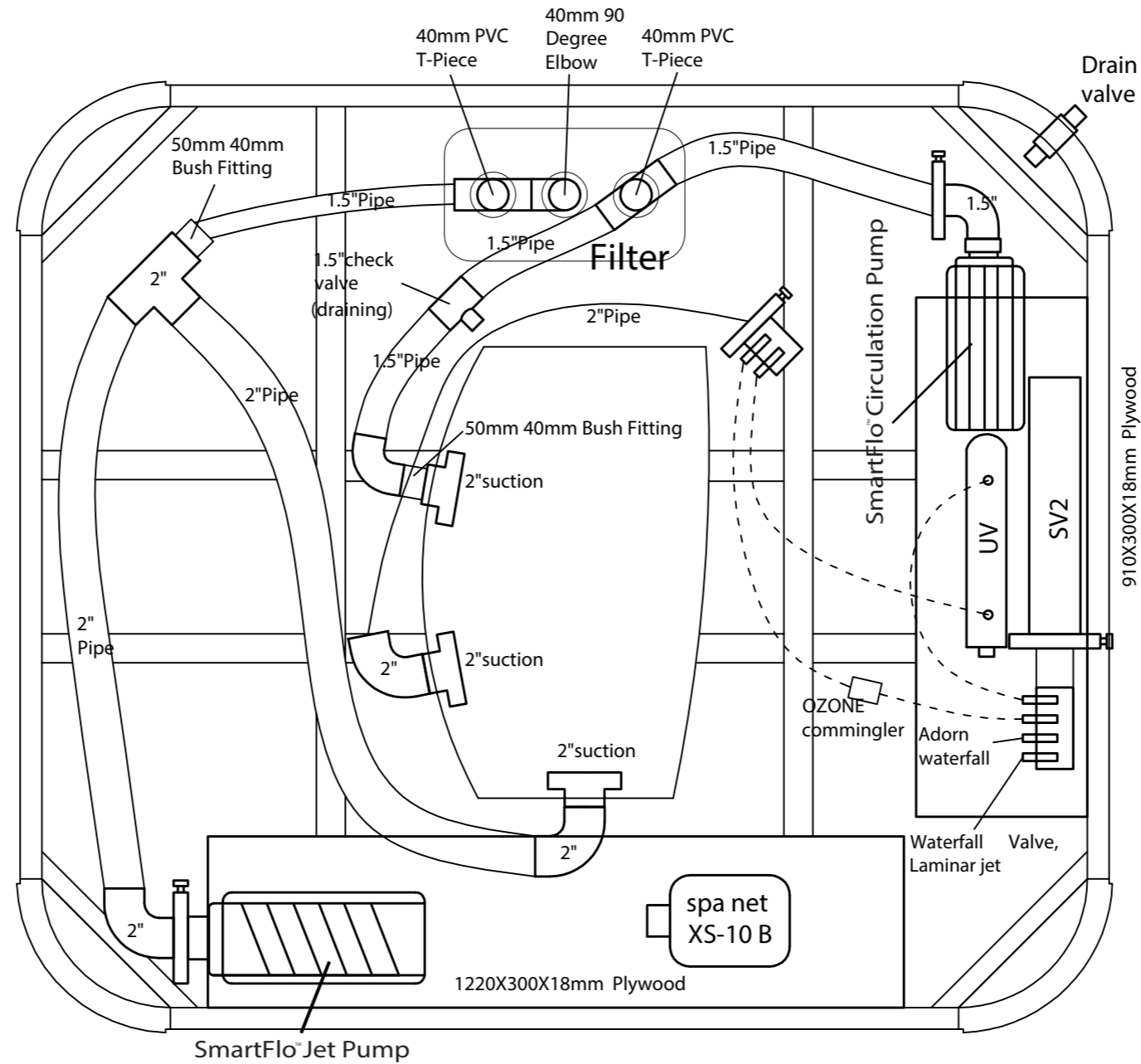

Barrason's Engineers  
 E: andrew@barrasonengineers.com  
 T: 0487 378 103  
 W: www.barrasonengineers.com

**VORTEX NEON**  
**PLUMBING DRAWINGS**

**FOR**  
**CONSTRUCTION**

DRAWING No:  
**S100**

CLIENT: SPA WORLD  
 JOB No: 2203283  
 SCALE: N/A

REVISION	AMENDED DESCRIPTION	DRAWN BY	DATE
A	FOR CONSTRUCTION	BE	30/03/22



# Vortex Neon<sup>TM</sup>

## Structural Certificate



**Building Act 1993**  
*Section 238(1)(a)*  
**Building Regulations 2018**  
*Regulation 126*

**CERTIFICATE OF COMPLIANCE FOR PROPOSED BUILDING WORK**

**This certificate is issued to**

The Relevant Building Surveyor

**This certificate is issued in relation to the proposed building work at:**

TBC

**Nature of proposed building work**

Proposed VORTEX NEON SPA

**Building classification**

Part of building: SPA

BCA Classification 10b

**Prescribed class of building work for which this certificate is issued:**

Design or part of the design of building work relating to Structural matter

**Documents setting out the design that is certified by this certificate**

Document no.	Document date	Type of document (e.g. drawings, computations, specifications, calculations etc.)	Prepared by
2209271	03/10/2022	<b>Eng Drawings – Rev. A</b> <i>As Nominated on the Sheet Index, Drawing Sheet S000</i>	Barrason's Engineers

**The design certified by this certificate complies with the following provisions of Building Act 1993, Building Regulations 2018 or National Construction Code**

Act, Regulation or NCC	Section, Regulation, Part, Performance Requirement or other provision
<b>BCA/NCC 2019</b>	Part 2.1, 3.0, 3.2, 3.4 of the NCC Vol. 2-2019 amendment 1 including relevant Australian Standards: AS1170.0, AS/NZ1170.1-2002, AS/NZ1170.2-2011, AS1684.2 AS1684.4, AS1720.1, AS2870, AS3600, AS3700, AS3850, AS4100, AS4055, AS4671, AS4773.1

I certify that the design set out in the documents listed above complies with the provisions set out above.

I believe that I hold the required skills, experience and knowledge to issue this certificate and can demonstrate this if requested to do so.



**Engineer:**

**Full Name:** Andrew Barraclough

**Registrations:** FIEAUST, CPEng, NER, RBP

**Qualifications:** BEng MEng PhD

**Address:** Lvl 2, 2 Pacific Promenade, Pakenham, VIC 3810

**Email:** [admin@barrasons.com.au](mailto:admin@barrasons.com.au)

**Endorsed building engineer area of engineering:** Structural

**Endorsed building engineer registration no.:** PE0000600, RPEQ 22822

Signed:

*Andrew Barraclough*

Date of issue of certificate: 03/10/2022



**SPA WORLD  
SPA STRUCTURAL DRAWINGS  
VORTEX NEON**

**Sheet Index**

Layout ID	Layout Name
S000	Title Sheet
S001	General Notes 1
S002	General Notes 2
S101	Framing Plan



Barrason's Engineers  
E: admin@barrasonengineers.com  
T: (03) 59 402 638  
W: www.barrasonengineers.com

**SPA STRUCTURAL DRAWINGS  
VORTEX NEON**

**FOR  
CONSTRUCTION**

**TITLE SHEET**

CLIENT: Tony Jones  
DRAWING No:  
JOB No: 2209271

S000

REVISION	AMENDED DESCRIPTION	DATE
A	FOR CONSTRUCTION	03/10/22

**GENERAL:**

1. ALL CONSTRUCTION WORKS AND MATERIALS TO CONFORM WITH THE ENGINEER SPECIFICATION AND AUSTRALIAN STANDARDS AND THE CURRENT BUILDING CODE OF AUSTRALIA.
2. ALL DIMENSIONS SHOWN ARE IN MILLIMETERS, AND LEVELS SHOWN ARE A.H.D. (AUSTRALIAN HT. DATUM)
3. THESE DRAWINGS SHALL BE READ IN CONJUNCTION WITH ALL MANUFACTURER'S SPECIFICATIONS AND INSTRUCTIONS DRAWING ARE NOT TO BE SCALED.RELEVANT DIMENSIONS TO BE CONFIRMED ON SITE BY BUILDER BEFORE COMMENCEMENT OF WORKS
4. ANY DISCREPANCIES OR QUERIES SHOULD BE REFERRED TO THE BARRASONENGINEERS FOR CLARIFICATIONS PRIOR TO COMMENCEMENT OF WORKS.
5. THE CONTRACTOR SHALL LIAISE WITH ANY BUILDING/ PROPERTY OWNERS AS REQUIRED TO ENSURE MINIMAL DISRUPTIONS TO SERVICES. AND THAT SPECISL REQUIREMENTS OF THE OWNERS ARE ADHERED TO.

- b. ROLLED FILL CONSISTS OF MATERIAL COMPACTED IN LAYERS BY REPEATED ROLLING WITH AN EXCAVATOR. ROLLED FILL SHALL NOT EXCEED 0.6m COMPACTED IN LAYERS NOT MORE THAN 0.3m THICK FOR SAND OR 0.3m COMPACTED IN LAYERS NOT MORE THAN 0.15m THICK FOR OTHER MATERIAL
- c. THE EXTENT OF CONTROLLED FILL AND ROLLED FILL REQUIRED SHALL BE DETERMINED ON SITE IN ACCORDANCE WITH SECTION 6 OF AS2870 AND SHALL BE THE RESPONSIBILITY OF THE CONTRACTOR & BUILDER.

- F8. WHERE DEPTH OF CONTROLLED FILL IS THICKER THAN THAT SPECIFIED ABOVE, FILL MATERIAL SHALL BE SPREAD AND COMPACTED IN UNIFORM LAYERS NOT EXCEEDING 0.15m THICK. TOP SURFACE LAYER SHALL BE COMPACTED TO MINIMUM 98% STANDARD DRY DENSITY DETERMINED BY METHODS IN ACCORDANCE WITH AS1289. LOWER LAYERS SHALL BE COMPACTED TO 95% STANDARD DRY DENSITY. THE MOISTURE CONTENT OF THE FILL MATERIAL SHALL BE ADJUSTED TO WITHIN 2% OF THE OPTIMUM MOISTURE CONTENT DURING COMPACTION TO ENSURE THAT THE SPECIFIED COMPACTION IS OBTAINED. COMPACTION TESTS SHALL BE CARRIED OUT AT A RATE OF ONE TEST PER LAYER PER 100 SQUARE METRES OF FILL. TESTS ARE TO BE CARRIED OUT BY INDEPENDENT NATA REGISTERED LABORATORIES. SUBMIT REPORT TO THIS OFFICE FOR APPROVAL.

- F9. FOUNDATIONS SHALL BE INSPECTED AND APPROVED BY THE ENGINEER OR BUILDING INSPECTOR BEFORE LAYING MEMBRANES AND POURING CONCRETE. IF AN UNUSUAL GROUND CONDITION IS ENCOUNTERED DURING THE SITE EXCAVATION, REPORT TO THIS OFFICE FOR RESOLUTION.

- F10. NO EXCAVATION IS TO BE TAKEN BELOW THE BASE OF ADJACENT / EXISTING FOOTINGS. IF IT IS UNAVOIDABLE, FOR THE CASE OF NEW FOOTINGS, BLINDING CONCRETE GRADE 15MPa SHALL BE PROVIDED BENEATH THE NEW FOOTING AND FOUNDING BELOW ANGLE OF REPOSE. FOR THE CASE OF EXISTING FOOTINGS, UNDERPINNING IS REQUIRED. REFER TO THIS OFFICE FOR DETAILS.

- F11. ALL FOUNDATIONS ARE TO BE FREE OF WATER AND LOOSE MATERIAL

- F12. OVER EXCAVATION IS TO BE FILLED TO THE UNDERSIDE OF FOOTINGS WITH 15MPa BLINDING CONCRETE

- F13. TERMITE PROTECTION SHALL BE PROVIDED AS REQUIRED BY AUSTRALIAN STANDARD AND THE LOCAL STATUTORY AUTHORITY.

- F14. A 0.2mm POLYTHENE MEMBRANE SHALL BE CONTINUOUS UNDER SLAB AND RIBS LAPPED 200mm MINIMUM WHERE REQUIRED AND TAPED AT ALL SERVICE PENETRATIONS, LAPS AND PUNCTURES. THE MEMBRANE IS TO EXTEND UNDER AND TO THE SIDES OF SLABS, BEAMS AND THICKENINGS.

- F15. EXCAVATIONS NEAR THE BUILDING EDGE SHALL BE BACKFILLED IN SUCH A MANNER TO PREVENT READY ACCESS OF WATER TO THE FOUNDATIONS

- F16. SYMBOLS ON THE DRAWING FOR REINFORCEMENT ARE AS FOLLOWS :

- Y GRADE 400MPa DEFORMED REINFORCING BARS TO AS 1302.
- N GRADE 500MPa DEFORMED REINFORCING BARS, DUCTILITY CLASS N TO AS 4671
- R GRADE 250MPa PLAIN REINFORCING BARS TO AS 1302
- TM HARD-DRAWN STEEL TRENCH MESH, GRADE 500 DUCTILITY CLASS L TO AS 4671
- RL RECTANGULAR RIB MESH GRADE 500 DUCTILITY CLASS L TO AS 4671
- SL SQUARE RIB MESH GRADE 500 DUCTILITY CLASS L TO AS 4671

- F17. FABRIC SHALL BE PLACED NEAR THE TOP OF THE SLAB AND SHALL HAVE A NOMINAL COVER OF 25mm U.N.O.
- F18. REINFORCEMENT FABRIC SHALL BE LAPPED SO THAT EACH PAIR OF TRANSVERSE WIRES AT THE EDGE OF ONE SHEET OVERLAPS EACH CORRESPONDING PAIR OF TRANSVERSE WIRES OF THE SHEET BEING LAPPED. REINFORCEMENT SHALL BE SUPPORTED IN POSITION PRIOR TO CONCRETING COMMENCING ON DENSE PRECAST CONCRETE SPACER BLOCKS OR BAR CHAIRS ON GALVANIZED STEEL DISHES (EITHER OF WHICH MUST NOT DAMAGE THE MEMBRANE) AT 900mm MAXIMUM CENTRES EACH WAY TRAMPING IN FABRIC IS NOT PERMITTED
- F19. BEAM AND STRIP FOOTING REINFORCEMENT SHALL HAVE A NOMINAL COVER OF 50mm.
- F20. TRENCH MESH SHALL BE LAID CONTINUOUSLY AND SHALL BE SPLICED WHERE NECESSARY WITH A MINIMUM LAP OF 500mm
- F21. TRENCH MESH SHALL BE OVERLAPPED BY THE WIDTH OF FABRIC AT CORNERS AND INTERSECTIONS. THE ENDS OF TRENCH MESH SHALL TERMINATE WITH A CROSSBAR.
- F22. PROVIDE 2N12 x 1200 BARS OR EQUIVALENT TRENCH MESH x 2000 LONG DIAGONALLY ACROSS RE-ENTRANT CORNERS OF SLAB AND TIED TO UNDERSIDE OF TOP FABRIC.
- F23. CONCRETE STRENGTH IS TO BE  $f_c = 25\text{MPa}$ , WITH 65 MAX. SLUMP, COMPACTED USING MECHANICAL VIBRATION. SLAB & RIBS ARE TO BE CAST IN ONE CONTINUOUS POUR AND THE SLAB IS TO BE STEEL-FLOAT FINISHED
- F24. ALL CONCRETE IS TO BE CONTINUOUSLY WET-CURED FOR 7 DAYS.
- F25. THE GROUND SURROUNDING SLABS SHALL HAVE THE SURFACE AT LEAST 150mm LOWER THAN THE SLAB AND BE SLOPED AWAY FROM THE SLAB EDGE SO THAT WATER WILL DISCHARGE TO SUITABLE DRAINAGE POINTS AND NOT FLOOD THE SLAB SURFACE.
- F26. HOT WATER HEATING PIPES MAY BE EMBEDDED IN THE SLAB PROVIDED THAT THE SLAB THICKNESS IS INCREASED BY 25mm AND LAID ON ADDITIONAL SL52 MESH.

C11 MINIMUM COVER TO ALL REINFORCEMENT INCLUDING FITMENTS SHALL BE AS FOLLOWS, U.N.O:

ELEMENT	FORMED AND NOT EXPOSED TO WEATHER	FORMED ON GROUND & EXPOSED TO WEATHER	NOT FORMED. CAST AGAINST GROUND
INSITU COLUMN & PEDESTALS	40	50	75
INSITU BEAMS	40	50	65
FOOTINGS	-	50	75
PIERS	-	50	75
SLABS ON GROUND	20	30	65
SUSPENDED SLABS	20	30	65
INSITU WALLS	25	30	65
PRECAST WALLS	25	30	65
UNDERPINNING	-	50	75

**FOOTINGS AND SLAB ON GROUND**

- F1. ALL WORK AND MATERIALS TO COMPLY WITH AS2870.
- F2. ALL FOOTINGS SHALL BE FOUNDED ON FIRMED SOIL. PRIOR TO COMENCING WORK, THE BUILDER IS TO FAMILIARISE THE CONTENT OF THE SOIL REPORT PREPARED BY: --  
REPORT No.: -- DATED: --  
FOOTING DEPTHS SPECIFIED ON THE DRAWINGS ARE MINIMUM DIMENSIONS ONLY. IF NOT SHOWN, REFER TO THE SOIL REPORT FOR THE REQUIRED FOUNDING DEPTH.
- F3. THE SITE HAS BEEN CLASSIFIED AS CLASS '- ' IN ACCORDANCE WITH AS 2870.
- F4. STRIP / PAD FOOTINGS ARE TO BE FOUNDED ON ORIGINAL UNDISTURBED GROUND WITH AN ALLOWABLE BEARING CAPACITY OF -- kPa.
- F5. EDGE BEAMS AND LOAD BEARING RIBS SHALL BE FOUNDED ON UNDISTURBED GROUND WITH AN ALLOWABLE BEARING CAPACITY OF -- kPa. THE INTERNAL SLAB & NON-LOAD BEARING RIBS SHALL BE FOUNDED ON SOIL WITH MINIMUM BEARING CAPACITY OF -- kPa.
- F6. ALL ORGANIC MATERIAL SHALL BE REMOVED FROM THE AREA BENEATH THE SLABS ON GROUND. THE GROUND SHALL BE PROOF ROLLED WITH A 3 TONNE ROLLER PRIOR TO PLACING COMPACTED FILL. ANY SOFT SPOTS SHALL BE DUG OUT AND REPLACED WITH COMPACTED CRUSHED ROCK OR 15MPa BLINDING CONCRETE. IN ACCORDANCE WITH AS2870 AND AS3798.
- F7. UNLESS OTHERWISE SPECIFIED IN THE SOIL REPORT, FILLING USED IN THE CONSTRUCTION OF THE SLAB EXCEPT WHERE THE SLAB IS SUSPENDED SHALL CONSIST OF CONTROLLED FILL OR ROLLED FILL AS FOLLOWS:  
a. CONTROLLED FILL IS MATERIAL THAT HAS BEEN PLACED AND COMPACTED IN LAYERS BY COMPACTION EQUIPMENT WITHIN DEFINED DENSITY REQUIREMENT. EXCEPT AS PROVIDED BELOW, CONTROLLED FILL SHALL BE PLACED IN ACCORDANCE WITH AS 3798.  
SAND FILL UP TO 0.8m DEEP, WELL COMPACTED IN NOT MORE THAN 0.3m THICK LAYERS BY A VIBRATING PLATE OR VIBRATING ROLLER, SHALL BE DEEMED TO COMPLY WITH THIS REQUIREMENT. A SATISFACTORY TEST FOR SAND FILL NOT CONTAINING GRAVEL SIZED MATERIAL IS THE ACHIEVEMENT OF A BLOW COUNT OF 7 OR MORE PER 0.3m USING THE PENETROMETER TEST DESCRIBED IN AS 1289.6.3.3.  
NON-SAND FILL UP TO 0.4m DEEP, WELL COMPACTED IN NOT MORE THAN 0.15m LAYERS BY A MECHANICAL ROLLER SHALL BE DEEMED TO COMPLY WITH THIS REQUIREMENT. CLAY FILL SHALL BE MOIST DURING COMPACTION.

- C12 REINFORCEMENT IS SHOWN DIAGRAMMATICALLY AND NOT IN TRUE PROJECTION. SYMBOLS ON THE DRAWING FOR REINFORCEMENT ARE AS FOLLOWS:
- C13 Y GRADE 400MPa DEFORMED REINFORCING BARS TO AS1302  
N GRADE 500MPa DEFORMED REINFORCING BARS, DUCTILITY CLASS N TO AS 4671  
R GRADE 250MPa PLAIN REINFORCING BARS TO AS1302  
W HARD-DRAWN STEEL REINFORCING WIRE, GRADE 500 DUCTILITY CLASS L TO AS 4671  
TM HARD-DRAWN STEEL TRENCH MESH, GRADE 500 DUCTILITY CLASS L TO AS 4671  
RL RECTANGULAR RIB MESH GRADE 500 DUCTILITY CLASS L TO AS 4671  
SL SQUARE RIB MESH GRADE 500 DUCTILITY CLASS L TO AS 4671
- C14 ALL REINFORCEMENT AND INSERTS SHALL BE SUPPORTED AND HELD IN THE DESIGN LOCATION BY APPROVED BAR CHAIRS, SPACERS OR TIES. BAR CHAIRS SHALL BE PLACED AT MINIMUM 1000 CENTRES IN TWO DIRECTIONS U.N.O.
- C15 WELDING AND THREADING OF REINFORCEMENT IS NOT PERMITTED WITHOUT THE APPROVAL OF THE ENGINEER.
- C16 REINFORCEMENT SHALL BE EVENLY DISTRIBUTED OVER THE WIDTHS SHOWN U.N.O.
- C17 PROVIDE 2-N12 x 1200 BARS DIAGONALLY ACROSS RE-ENTRANT CORNERS OF SLABS, TIED UNDER THE TOP FABRIC. U.N.O.
- C18 AT SLAB EDGES INCLUDING CONSTRUCTION AND OTHER JOINTS, AT LEAST ONE REINFORCING BAR OR FABRIC WIRE SHALL BE LOCATED PARALLEL TO AND WITHIN 75mm OF THE SLAB EDGE.
- C19 CONSTRUCTION JOINTS SHALL BE PROPERLY FORMED AND USED ONLY WHERE APPROVED OR PERMITTED BY THE ENGINEER.
- C20 SAWN JOINTS SHALL BE MADE AT A TIME APPROPRIATE TO THE CONCRETE MIX AND CLIMATIC CONDITIONS, GENERALLY BETWEEN 10 AND 20 HOURS OF PLACING THE CONCRETE.
- C21 STRIPPING OF FORMS AND REMOVAL OF FORMWORK SHALL TAKE PLACE IN ACCORDANCE WITH A PROCEDURE AGREED TO BY THE ENGINEER.
- C22 CONCRETE MUST BE SEPARATED FROM SUPPORTING MASONRY WORK BY TWO LAYERS OF A SUITABLE DE-BONDING MEMBRANE.
- C23 SUSPENDED SLABS SHALL BE GIVEN AN UPWARD MID-SPAN CAMBER OF 3mm PER 1000mm U.N.O. BEAMS SHALL BE AS SHOWN ON DRAWINGS.
- C24 SPLICES IN REINFORCEMENT SHALL BE MADE IN THE POSITIONS SHOWN ON THE DRAWINGS OR AS OTHERWISE APPROVED BY THE ENGINEER.
- C25 HOLDING-DOWN BOLTS SHALL BE SUPPLIED TO THE CONCRETOR FOR CASTING INTO THE CONCRETE AND SHALL BE INSTALLED IN ACCORDANCE WITH THE STEEL HOLDING-DOWN BOLT PLAN.

**CONCRETE:**

- C1 ALL WORK AND MATERIALS SHALL BE IN ACCORDANCE WITH AS3600.
- C2 UNLESS OTHERWISE SHOWN THE MINIMUM 28 DAY COMPRESSIVE STRENGTH OF CONCRETE SHALL BE AS FOLLOWS:

ELEMENT	CONC. STRENGTH ( $f_c$ ) MPa	SLUMP mm
FOOTINGS	25	75
SLAB-ON-GROUND	25	65
COLUMNS	32	80
WALLS	40	85
SUSPENDED SLABS & BEAMS	32	80
MASS CONCRETE	15	-

- C3 CONCRETE SHALL BE CURED BY AN APPROVED METHOD FOR AT LEAST 7 DAYS AFTER PLACEMENT.
- C4 CONCRETE SHALL BE COMPACTED USING MECHANICAL VIBRATION.
- C5 VIBRATION OF FORMS IS NOT ACCEPTABLE AND CONCRETE SHALL NOT BE SPREAD BY VIBRATING.
- C6 CONCRETE SECTIONS SHOWN ARE MINIMUM SIZES AND DO NOT INCLUDE FINISHES. SIZES SHALL NOT BE REDUCED IN ANY WAY OR HOLES FORMED OR MADE IN
- C7 DEPTH OF BEAMS ARE GIVEN FIRST AND INCLUDE SLAB THICKNESS
- C8 SLABS AND BEAMS ARE TO BE POURED CONCURRENTLY U.N.O. AND FINISHED WITH A STEEL FLOAT.
- FE POOL PAVERS CONCRETE AND MASONRY PAVERS SURROUNDING POOLS TO BE CONSTRUCTED TO REQUIREMENTS OF AS3727.1-2016, PAVEMENTS, PART 1: RESIDENTIAL.
- C10 RECOMMENDED CONCRETE SLAB TO BE 150MM THICK, CONCRETE GRADE N32, SL82 REINFORCEMENT WITH 30MM COVER TO THE TOP SURFACE AND 40M SIDE COVER. MINIMUM SOIL ALLOWABLE BEARING CAPACITY TO BE 100KPA.



**Barrason's Engineers**  
E: admin@barrasonengineers.com  
T: (03) 59 402 638  
W: www.barrasonengineers.com

**SPA STRUCTURAL DRAWINGS  
VORTEX NEON**

**FOR  
CONSTRUCTION**

**GENERAL NOTES**

CLIENT: Tony Jones	S001	REVISION	AMENDED DESCRIPTION	DATE
DRAWING No:		A	FOR CONSTRUCTION	03/10/22
JOB No: 2209271				

**STRUCTURAL STEELWORK:**

- S1 ALL WORK AND MATERIALS SHALL BE IN ACCORDANCE WITH AS 4100.
- S2 ALL STEEL SHALL BE NEW AND FREE FROM WELDS AND BLEMISHES UNLESS APPROVED BY THE ENGINEER.
- S3 FABRICATION AND ERECTION SHALL BE IN ACCORDANCE WITH AS 4100 AND SAA/SNZ HB62.
- S4 HOT-ROLLED AND WELDED PRODUCTS SHALL BE BHP-300PLUS AND PLATE SHALL BE GRADE 250 U.N.O.
- S5 ALL WELDING SHALL BE IN ACCORDANCE WITH AS 1554.
- S6 WELD TYPES ARE DESIGNATED AS FOLLOWS  
CFW - CONTINUOUS FILLET WELD  
FPBW - FULL PENETRATION BUTT WELD  
PPBW - PARTIAL PENETRATION BUTT WELD
- S7 ALL WELDS SHALL BE 6mm CONTINUOUS FILLET, CATEGORY GP, USING E41XX/W40X CONSUMABLES U.N.O.
- S8 WELDING SHALL BE PERFORMED BY AN EXPERIENCED OPERATOR IN ACCORDANCE WITH AS 1554 INSPECTED & CERTIFIED BY QUALIFIED PERSONNEL IN ACCORDANCE WITH AS2214
- S9 ALL HIGH-STRENGTH STRUCTURAL BOLTS SHALL BE M20 GRADE 8.8/S U.N.O. IN ACCORDANCE WITH AS 1252
- S10 HOLDING-DOWN BOLTS SHALL BE M20 GRADE 4.6/S, GALVANISED U.N.O
- S11 BOLTS MUST BE OF SUFFICIENT LENGTH TO HAVE AT LEAST ONE FULL THREAD EXPOSED AFTER TIGHTENING
- S12 BOLTS IN OVERSIZE OR SLOTTED HOLES ARE TO HAVE SUITABLE LARGER SIZE WASHERS
- S13 CONNECTIONS NOT SPECIFICALLY DETAILED SHALL BE IN ACCORDANCE WITH THE APPROPRIATE CONNECTION AS DETAILED IN THE AISC STANDARDISED STRUCTURAL CONNECTIONS MANUAL.
- S14 UNLESS NOTED OTHERWISE CONNECTIONS BETWEEN 2 STRUCTURAL STEEL MEMBERS ARE TO HAVE MINIMUM 2M20 8.8/S BOLTS IN 22Ømm HOLES
- S15 BOLT TYPES AND BOLTING PROCEDURE ARE DESIGNATED AS FOLLOWS  
4.6/S - COMMERCIAL BOLTS TO AS 1111, SNUG TIGHTENED  
8.8/S - HIGH STRENGTH STRUCTURAL BOLTS, NUTS AND HARDENED WASHERS TO AS 1252, SNUG TIGHTENED  
8.8/TB - HIGH STRENGTH STRUCTURAL BOLTS AS ABOVE, FULLY TENSIONED TO AS 1511 IN A BEARING TYPE JOINT  
8.8/TF - HIGH STRENGTH STRUCTURAL BOLTS AS ABOVE, FULLY TENSIONED TO AS 1511 IN A FRICTION TYPE JOINT
- S16 FULLY TENSIONED BOLTS ARE TO BE INITIALLY SNUG TIGHTENED, CONNECTING PLATES ADJUSTED TO FULL CONTACT, THEN TIGHTEN BOLTS TO AN ADDITIONAL HALF TURN IN ACCORDANCE WITH AS 4100 ALTERNATIVELY PROVIDE LOAD INDICATING WASHERS AND INSTALL CONNECTIONS IN ACCORDANCE WITH MANUFACTURERS RECOMMENDATIONS AND AS 4100
- S17 ALL CLEAT PLATES AND STIFFENERS SHALL BE 10mm THICK U.N.O.
- S18 THE ENDS OF ALL TUBULAR MEMBERS SHALL BE SEALED WITH A 3mm PLATE U.N.O.
- S19 TUBULAR MEMBERS TO BE GALVANISED SHALL BE ADEQUATELY VENTED.
- S20 PURLINS AND GIRTS INCLUDING LATERAL AND BUCKLING RESTRAINING MEMBERS SUCH AS BRIDGING, STRUTS AND TIE RODS SHALL BE IN ACCORDANCE WITH AS/NZS 4600, GALVANISED AND INSTALLED IN ACCORDANCE WITH THE MANUFACTURER'S RECOMMENDATIONS
- S21 BEFORE COMMENCING FABRICATION 3 COPIES OF THE SHOP DRAWINGS SHALL BE SUBMITTED TO THE ENGINEER FOR REVIEW. THIS REVIEW DOES NOT INCLUDE CHECKING OF DIMENSIONS.
- S22 CAMBER SHALL BE AS NOTED ON THE DRAWINGS.
- S23 STRUCTURAL STEEL TO BE CONCRETE ENCASED SHALL BE WRAPPED WITH F41 MESH. THE GAP BETWEEN THE STRUCTURAL STEEL AND THE MESH AND AND THE THE EXTERNAL COVER TO THE MESH SHALL BE 25mm AND 50mm RESPECTIVELY.
- S24 ALL BOLTS AND STRUCTURAL STEEL EXPOSED TO THE WEATHER SHALL BE HOT-DIP GALVANISED U.N.O. PAINT SYSTEMS TO GALVANISED STEEL TO BE AS SPECIFIED BY THE ARCHITECT

- S25 ALL STEEL LINTELS SUPPORTING MASONRY EXPOSED TO THE WEATHER SHALL BE HOT-DIP GALVANISED.
- S26 PROVIDE ALL NECESSARY CLEATS AND HOLES REQUIRED TO FIX TIMBER AND OTHER MATERIALS AND FINISHES TO THE STEELWORK.
- S27 LINTELS SHALL NOT BE PROPPED DURING LOAD APPLICATION U.N.O.
- S28 THE CONTRACTOR SHALL PROVIDE AND LEAVE IN PLACE UNTIL PERMANENT BRACING ELEMENTS ARE CONSTRUCTED, SUCH TEMPORARY BRACING AS IS NECESSARY TO ADEQUATELY STABILIZE THE STRUCTURE DURING ERECTION.
- S29 PROVIDE 150mm MINIMUM END BEARING WITH 20mm NOM. LEVELLING GROUT U.N.O. TO STEELWORK SEATED ON MASONRY. CHARACTERISTIC COMPRESSIVE STRENGTH OF GROUT IS 30MPa
- S30 PROTECTIVE COATINGS TO INTERNAL STEELWORK (U.N.O.):  
PREPARATION: CLASS 2A ABRASIVE BLAST  
COATING:  
FIRST COAT INORGANIC ZINC SILICATE  
75 DRY FILM THICKNESS  
SECOND COAT ACRYLIC PAINT  
50 DRY FILM THICKNESS  
THIRD COAT ACRYLIC PAINT  
50 DRY FILM THICKNESS  
CONCRETE ENCASED AND FIRE-SPRAYED MEMBERS, AND FRICTION-GRIP BOLTED CONNECTIONS MUST NOT BE PAINTED. U.N.O.
- S31 COATINGS DAMAGED DURING TRANSPORT AND ERECTION OR BY WELDING SHALL BE MADE GOOD AFTER BEING WIRE-BRUSHED CLEAN, AND RECOATED AS ABOVE.
- S32 REFER TO ARCHITECTURAL DRAWINGS FOR ALL ADDITIONAL PLATES, ANGLES ETC. AS REQUIRED FOR FIXINGS TO INTERNAL PARTITIONS, BLOCKING, WINDOW FRAMES,
- S33 PROVIDE ALL NECESSARY TRIMMING ANGLES AND FIXINGS TO SUPPORT CLADDING AND FLASHINGS AT ROOF OR WALL INTERSECTIONS
- S34 PROVIDE ALL NECESSARY SUBFRAMES AND TRIMMERS FOR MECHANICAL AND ELECTRICAL EQUIPMENT AND ARCHITECTURAL FEATURES
- S35 SUPPORT ROOF BRACING FROM EVERY SECOND PURLIN WITH HOOK BOLTS

**SPA MAUFACTURE:**

- CONSTRUCTION SEQUENCE :
- STEP 1. VACUUM FORM USING 4.75MM ARISTECH ACRYLIC SHEET
  - STEP 2 FIRST COATING 1.5MM - 2MM USING APPROX. 40:60 RATIO (GLASS TO RESIN)  
FIBREGLASS PRAY UP ROVING : 110P VINYL ESTER RESIN  
CATALYST M50 (1.8% - 2%)
  - STEP 3. OVEN CURE AT 35-40 DEGREES CELSIUS
  - STEP 4. SECOND COATING 4MM - 8MM USING APPROX. 40:60 RATIO (GLASS TO RESIN)  
FIBREGLASS PRAY UP ROVING : 279P POLYESTER RESIN  
CATALYST 388 (1.8% - 2%)  
CALCIUM CARBONATE FILLER ON SECOND LAYER

**NOTES**

SWIMMING POOL AND SPA SAFETY TO FOLLOW THE GUIDELINES OF PN-05-2018 PUBLISHED BY VBA.

BARRIERS AND LOCATION OF BARRIERS TO BE DESIGNED TO REQUIREMENTS OF AS 1926.1-2012 AND AS 1926.2-2007, SWIMMING POOL SAFETY - SAFETY BARRIERS FOR SWIMMING POOLS.

DESIGN AND INSTALL POOLS AND SPAS MANUFACTURED FROM FIBREINFORCED PLASTIC MATERIALS, WITH VOLUMES EXCEEDING 7500L AND DEPTHS GREATER THAN 750MM, TO REQUIREMENTS OF AS/NZS 1838:1994, SWIMMING POOLS - PREMOULDED FIBRE-REINFORCED PLASTICS - DESIGN AND FABRICATION.



**Barrason's Engineers**  
E: admin@barrasonengineers.com  
T: (03) 59 402 638  
W: www.barrasonengineers.com

**SPA STRUCTURAL DRAWINGS  
VORTEX NEON**

**FOR  
CONSTRUCTION**

**GENERAL NOTES**

CLIENT: Tony Jones	S002	REVISION	AMENDED DESCRIPTION	DATE
DRAWING No:		A	FOR CONSTRUCTION	03/10/22
JOB No: 2209271				

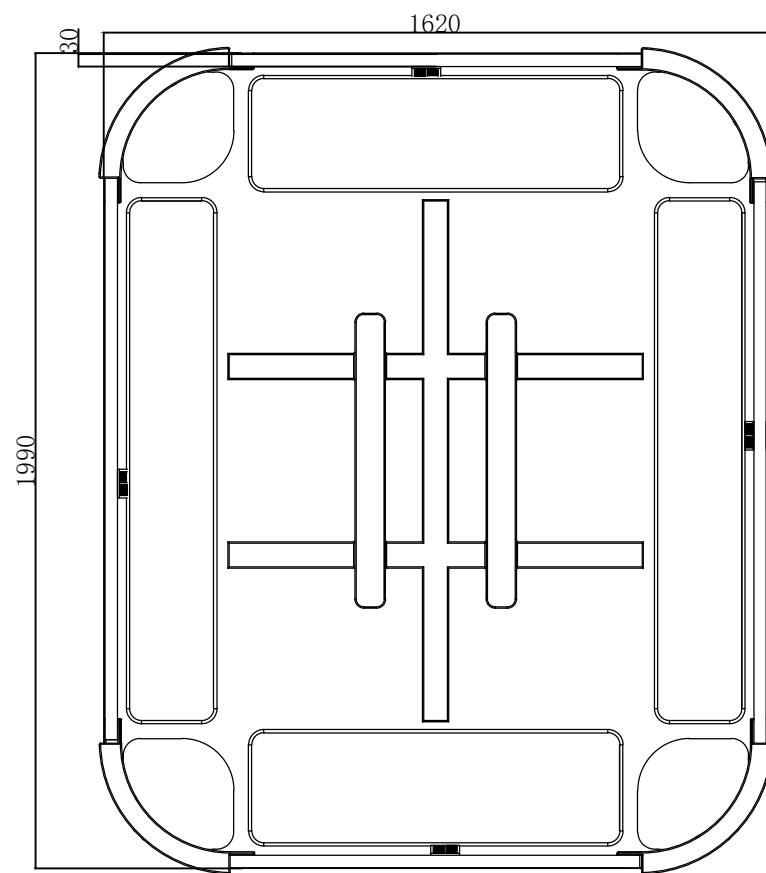

PLAN VIEW

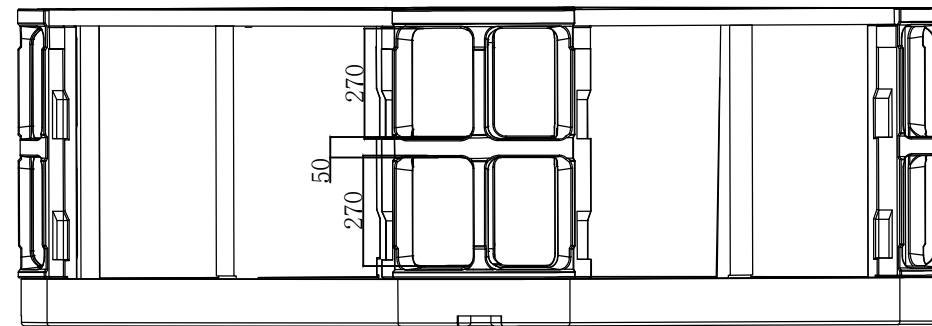
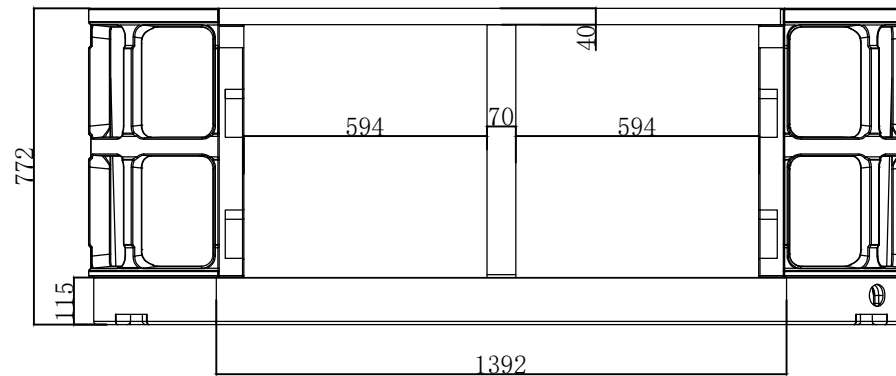

SECTIONS



Barrason's Engineers  
 E: admin@barrasonengineers.com  
 T: (03) 59 402 638  
 W: www.barrasonengineers.com

**SPA STRUCTURAL DRAWINGS  
 VORTEX NEON**

**FOR  
 CONSTRUCTION**

**FRAMING PLAN**

CLIENT: Tony Jones

DRAWING No:

JOB No: 2209271

S101

REVISION	AMENDED DESCRIPTION	DATE
A	FOR CONSTRUCTION	03/10/22



# Vortex<sup>TM</sup> Spas

---

Available exclusively at *Spa* WORLD