

NZXT

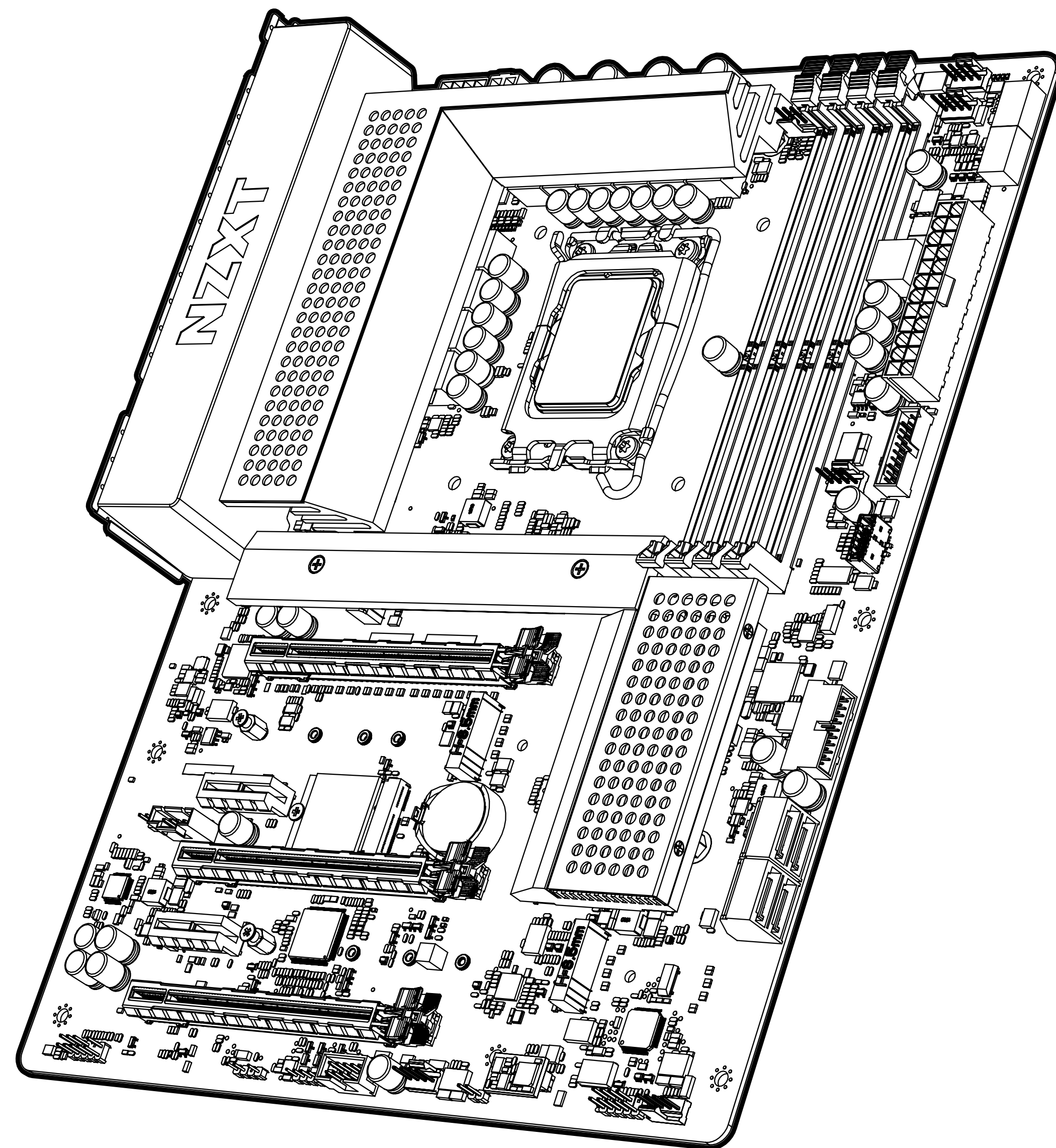

N5 Z690

INTEL Z690 ATX MOTHERBOARD

1. 前言 02

2. 产品信息 03

3. 组件和端口 09/10/11

4. 下载 NZXT CAM 41

5. 附录 A-1



A. 版权所有 © NZXT, Inc. 保留所有权利。

本手册（包括所有插图和屏幕截图）受国际版权法保护，保留所有权利。未经作者书面许可，不得复制本手册及其中包含的任何材料。

B. 免责声明

本文档中的信息如有更改，恕不另行通知。制造商不对本文档的内容作任何陈述或担保，特别声明不对任何适销性或针对特定用途的适用性作任何默示担保。制造商保留修改本出版物并不时对其内容进行更改的权利，同时制造商并无义务将此类修订或更改通知任何人。

C. 商标识别

本手册中使用的产品名称是其各自所有者的财产，并已获得认可。

D. 安全预防措施

安装主板时，请遵循以下安全预防措施：

- 建议佩戴连接接地装置的接地带，避免静电损坏。
- 在主板上进行操作之前，请触摸某个安全接地物体的金属外壳以释放静电。
- 将组件放在防静电袋中。
- 在安装或卸下主板或其他硬件组件之前，请务必从电源插座上拔下电源线从而断开交流电源。

2. 产品信息



2.1 包装内容04

2.2 技术规格05

2.1 包装内容

N5 Z690 INTEL ATX MOTHERBOARD



A. N5 Z690 主板

x1

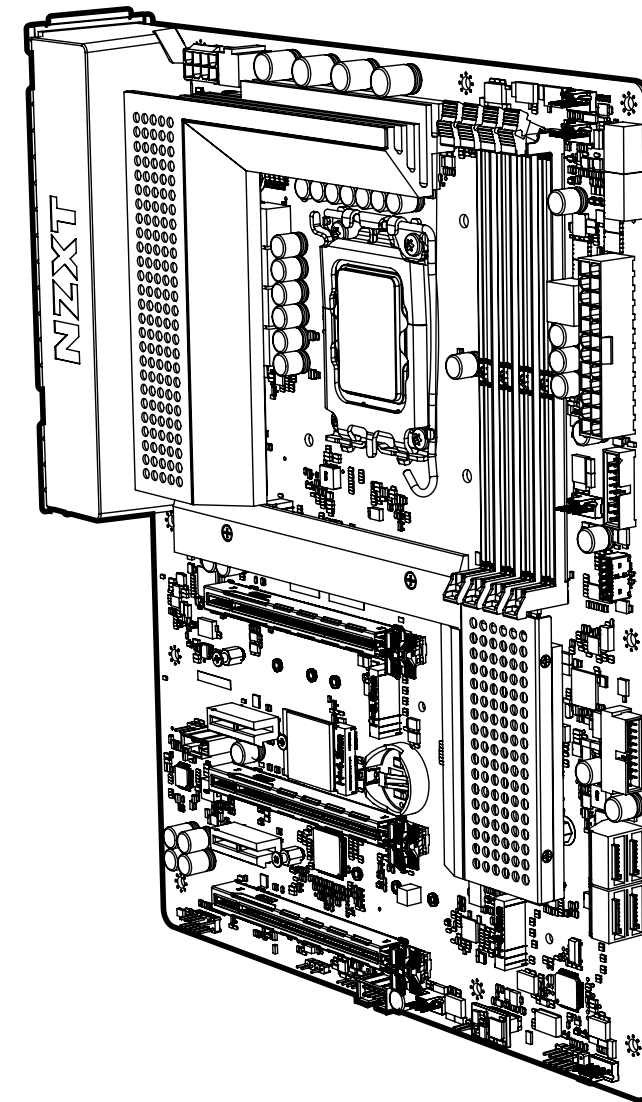

B. SATA 线

90°x2, 180°x2

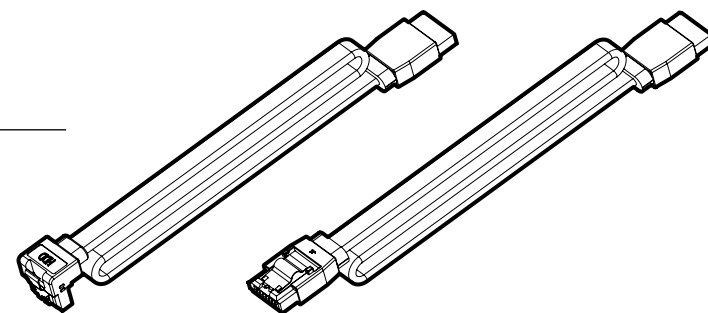

C. M.2螺丝

x3



D. 无线天线

x2

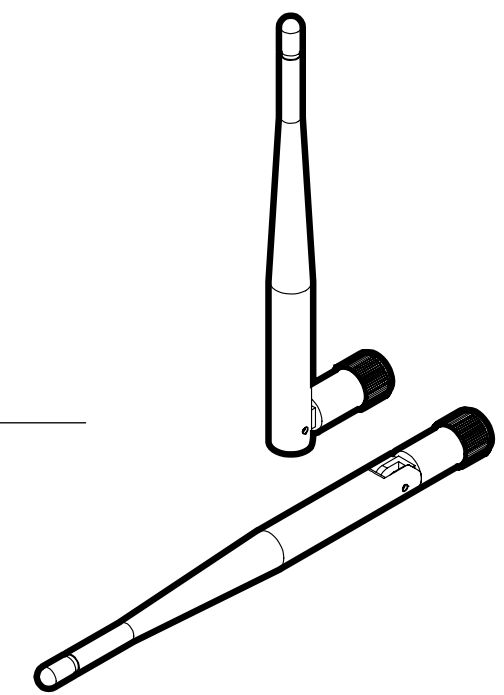



CPU 和插槽

LGA 1700 插座，适用于 Intel® 第 12 代 Core™ i9/Core™ i7/
Core™ i5 处理器

- 支持 Intel® 混合技术
- 支持 Intel® Turbo Boost Max 3.0 技术

芯片组

Intel® Z690

内存

4 x DIMM 插槽，最大128GB，双通道 DDR4 内存

- 支持 DDR4 非 ECC 无缓冲内存，最高可达 5000+ (OC)*
- 支持 ECC UDIMM 内存 (在非 ECC 模式下运行)
- 支持 Intel® Extreme Memory Profile (XMP) 2.0

* 原生支持 DDR4 3200

* 详情请参阅 NZXT 网站 (www.nzxt.com) 的“Memory QVL”部分。

扩展插槽

3 x PCIe ×16 插槽

(1 个 - PCIe_1 : Gen 5 ×16 模式)

(2 个 - PCIe_1 : Gen 5 ×16 、 PCIe_3 : Gen 4 ×4)

(3 个 - PCIe_1 : Gen 5 ×16 、 PCIe_3 : Gen 4 ×4 、 PCIe_5 : Gen 3 ×1)

2 x PCIe Gen 3 ×1 插槽

- 支持 AMD Quad CrossFireX™ 和 CrossFireX™

1 x M.2 插座 (E 键) ，支持 2230 型 Wi-Fi/BT 模块，Intel® CNVio

* 支持 NVMe SSD 作为启动盘



集成显卡

- 集成图形处理器——支持 Intel® UHD 显卡 *
- Intel® Xe 显卡架构 (Gen 12)
- 支持 HDMI™ 2.1 TMDS，最大兼容分辨率达 4K x 2K (4096x2160) @ 60Hz
- 通过 HDMI 2.1 端口支持 HDCP 2.3

* 仅通过 GPU 集成处理器支持

存储

Intel® Z690 芯片组

- 1 x M.2_1 2242/2260/2280 型 (PCIe Gen 4 x4 模式) *
- 1 x M.2_2 2242/2260/2280 型 (PCIe Gen 4x4 模式) *
- 1 x M.2_3 2242/2260/2280/22110 型 (PCIe Gen 4x4 和 SATA6Gb/s 模式) *
- 1 x M.2_4 2242/2260/2280 型 (PCIe Gen 4x4 模式) *
- 4 x SATA 6Gb/s 端口

支持 RAID 0/1/5/10，适用于 SATA 存储设备

支持 RAID 0/1/5，适用于 M.2 NVMe 存储设备

* 支持 Intel® Volume Management Device (VMD)

* 支持 Intel® Optane 技术

* 支持 NVMe SSD 作为启动盘

LAN

Realtek® RTL8125BG 2.5G LAN

无线

双频 Wi-Fi 6E

- Wi-Fi 802.11 a/b/g/n/ax
- 支持双频 2x2 160MHz，可扩展至 6GHz *
- 支持 MU-MIMO

* Wi-Fi 6E (频段 6GHz) 在 Microsoft® Windows® 11 系统中可用，其可用性因国家及地区而异。要实现 6E 功能，需要支持 6GHz 的路由器。



蓝牙

蓝牙 V5.2

音频

Realtek® ALC897 编解码器
8 声道高保真音频

后部 I/O

- 2 x 无线天线 SMA 连接器
- 1 x HDMI™ 端口
- 2 x USB 2.0 端口
- 1 x USB 3.2 Gen 2x2 Type-C 端口
- 1 x USB 3.2 Gen 2 端口
- 4 x USB 3.2 Gen 1 端口
- 1 x BIOS Flashback 按钮
- 1 x LAN (RJ45) 端口
- 1 x 高清音频插孔：线路输入/前置扬声器/麦克风

内部 I/O

- 1 x 24 针 ATX 电源接口
- 1 x 8+4 针 ATX 12V 电源接口
- 1 x 4 针 CPU_FAN 接口 (每个通道最高 24W)
- 1 x 4 针 AIO_PUMP 接口 (每个通道最高 24W)
- 4 x 4 针 SYS_FAN 接口 (每个通道最高 24W)
- 2 x NZXT RGB LED 接口
- 1 x 5V 可寻址 RGB LED 接口
- 1 x 12V RGB LED 接口
- 1 x SPI TPM 接头
- 1 x USB 2.0 接头 (最多 2 个 USB 2.0 端口)
- 2 x USB 3.2 Gen 1 接头 (最多 4 个 USB 3.2 Gen 1 端口)
- 1 x USB 3.2 Gen 2x2 前面板接头 (用于 USB Type C)
- 1 x 前面板音频接口
- 4 x 开机自检 LED



操作系统

Microsoft® Windows® 11/10 (64 位)

外形尺寸

ATX

系统要求

NZXT CAM 软件需要 Microsoft Windows®11/10 操作系统。

NZXT CAM 可免费下载使用；某些功能需要提供有效电子邮件地址，接受我们的最新服务条款并且连接有效网络。



3.1 分解图 12

3.2 端口概览 13

3.3 后部 I/O 16

3.4 CPU 插槽 17

3.5 DIMM 插槽 19

3.6 PCI Express 扩展插槽 21

3.7 SATA 接口 23

3.8 M.2 硬盘插槽 24

3.9 M.2 插槽无线连接 26

3.10 天线 27

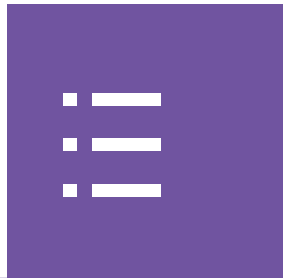

3.11 电源接口28

3.12 USB 接口29

3.13 前面板音频接口 30

3.14 前面板接口31

3.15 风扇接口32

3.16 NZXT RGB 接口33

3.17 5V 可寻址 RGB 接口34

3.18 12V RGB 接口35

3.19 SPI TPM 接头36

3.20 Clear CMOS 接头37



3.21 CMOS 电池39

3.22 BIOS Flashback 40

3.1 分解图

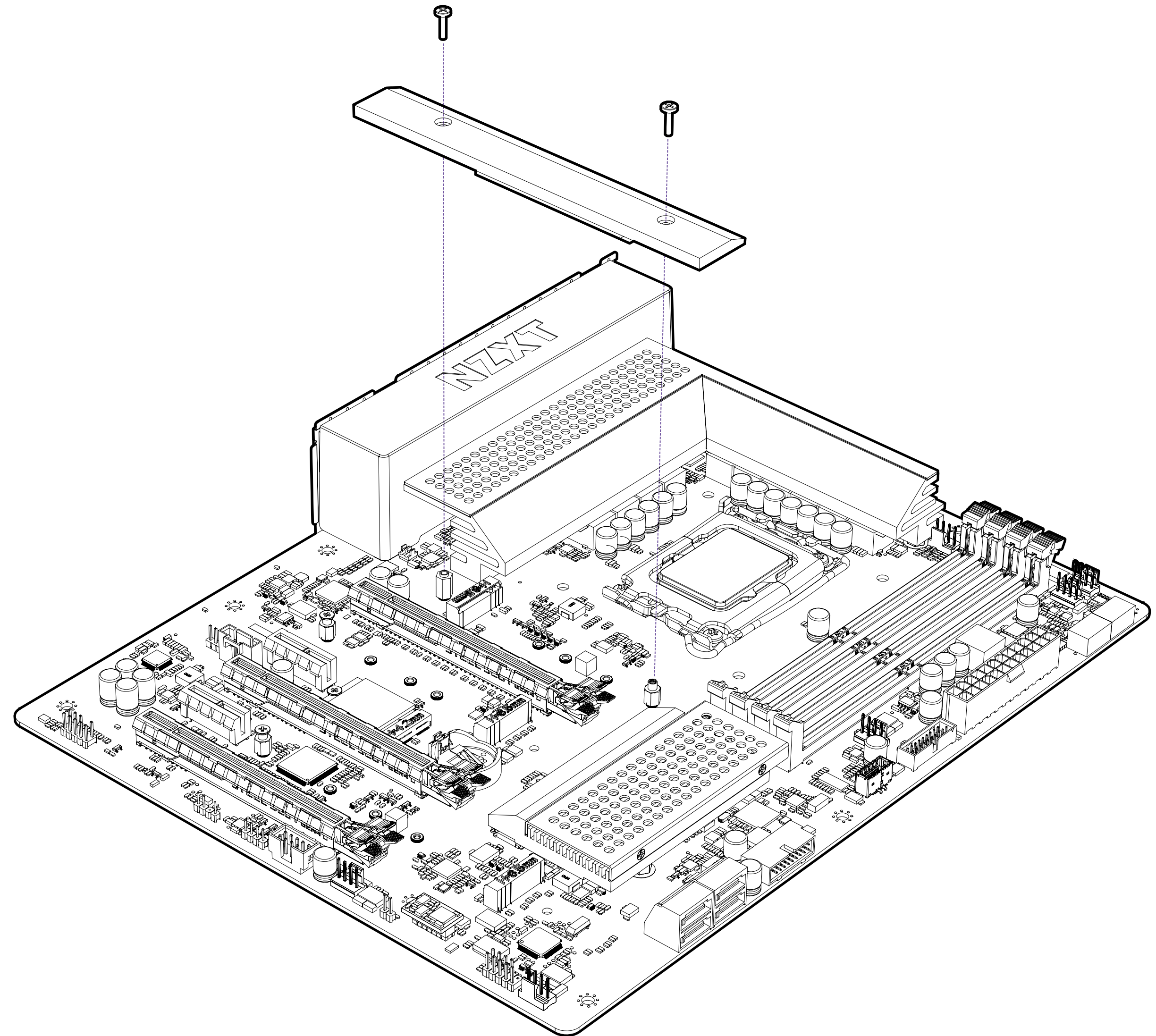

3.3 端口概览

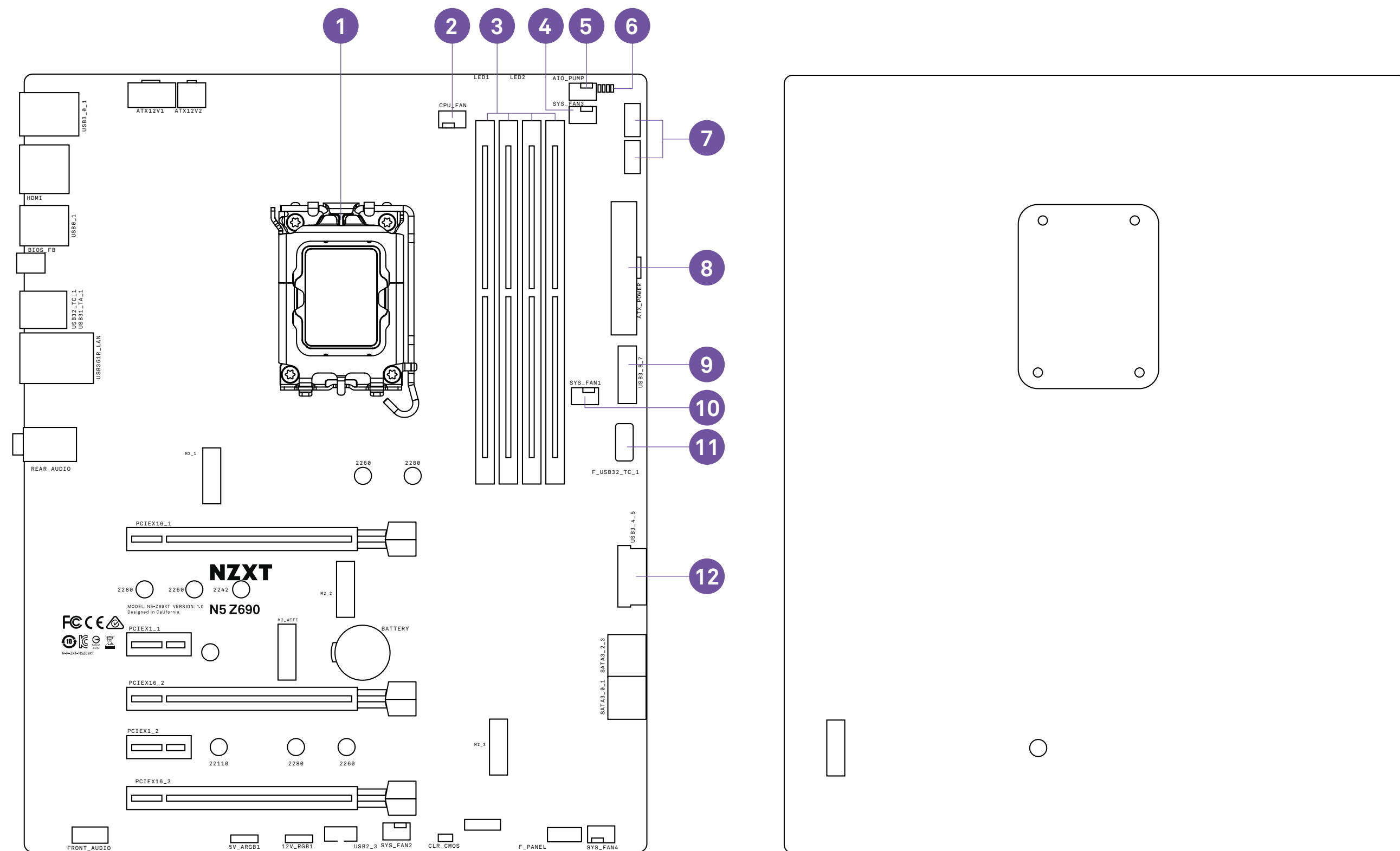

NO.	PORT NAME	DESCRIPTION
1	CPU 插槽	LGA 1700 插座 · 适用于 Intel 第 12 代处理器
2	CPU_FAN	4 针 CPU 风扇接口
3	DIMM A1-B2	288 针 DDR4 内存插槽
4	SYS_FAN 3	4 针风扇接口
5	AIO_PUMP	4 针 AIO 泵接口
6	开机自检 LED	开机状态指示灯
7	NZXT RGB 1 和 2	4 针 LED 接头
8	ATX_POWER	24 针 ATX 电源接口
9	USB3_6_7	前面板 USB 3.2 Gen 1 接头
10	SYS_FAN 1	4 针风扇接口
11	USB32_TC_1	前面板 USB 3.2 Gen 2 Type-C 接头
12	USB3_4_5	前面板 USB 3.2 Gen 1 接头

3.3 端口概览

N5 Z690 INTEL ATX MOTHERBOARD

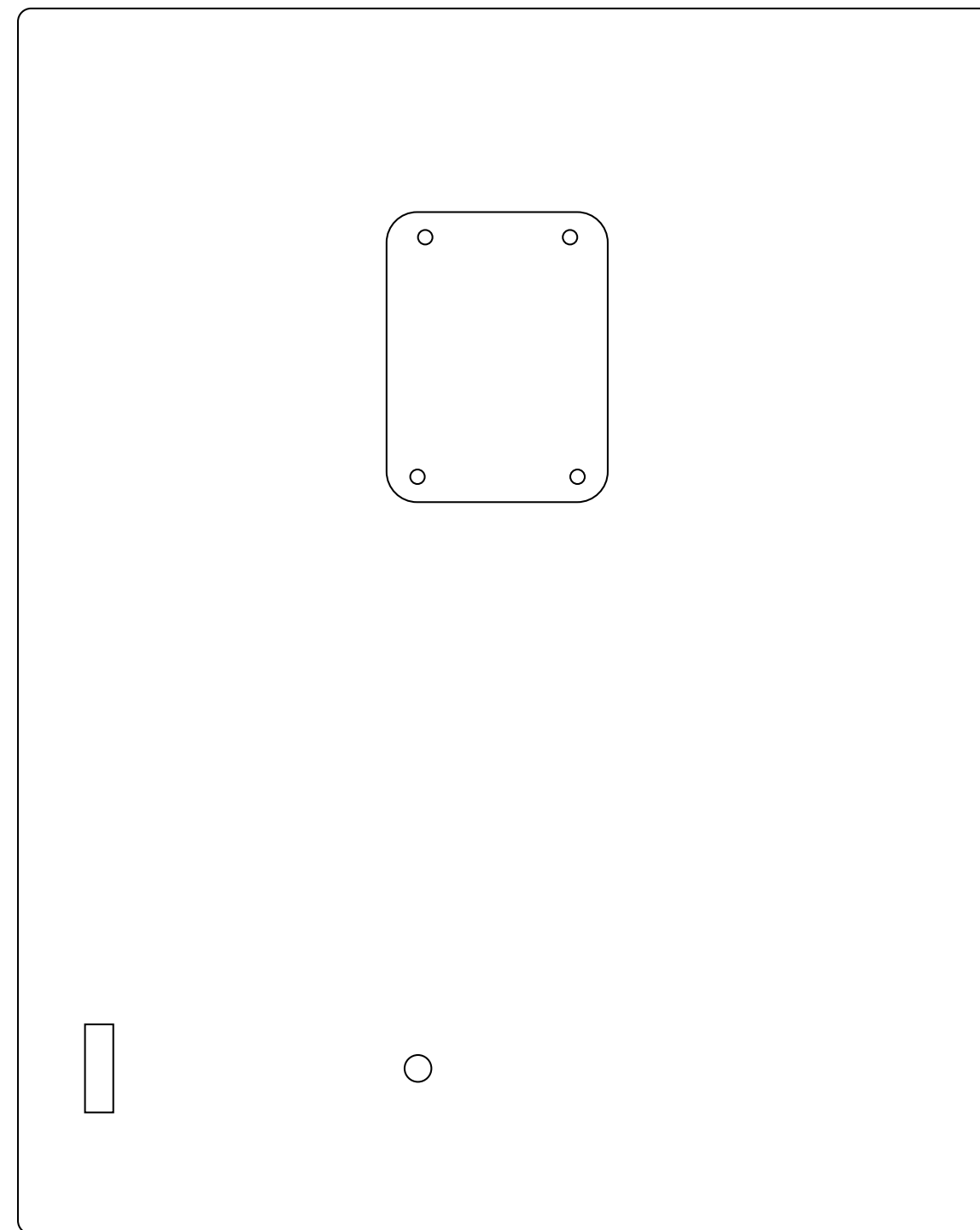
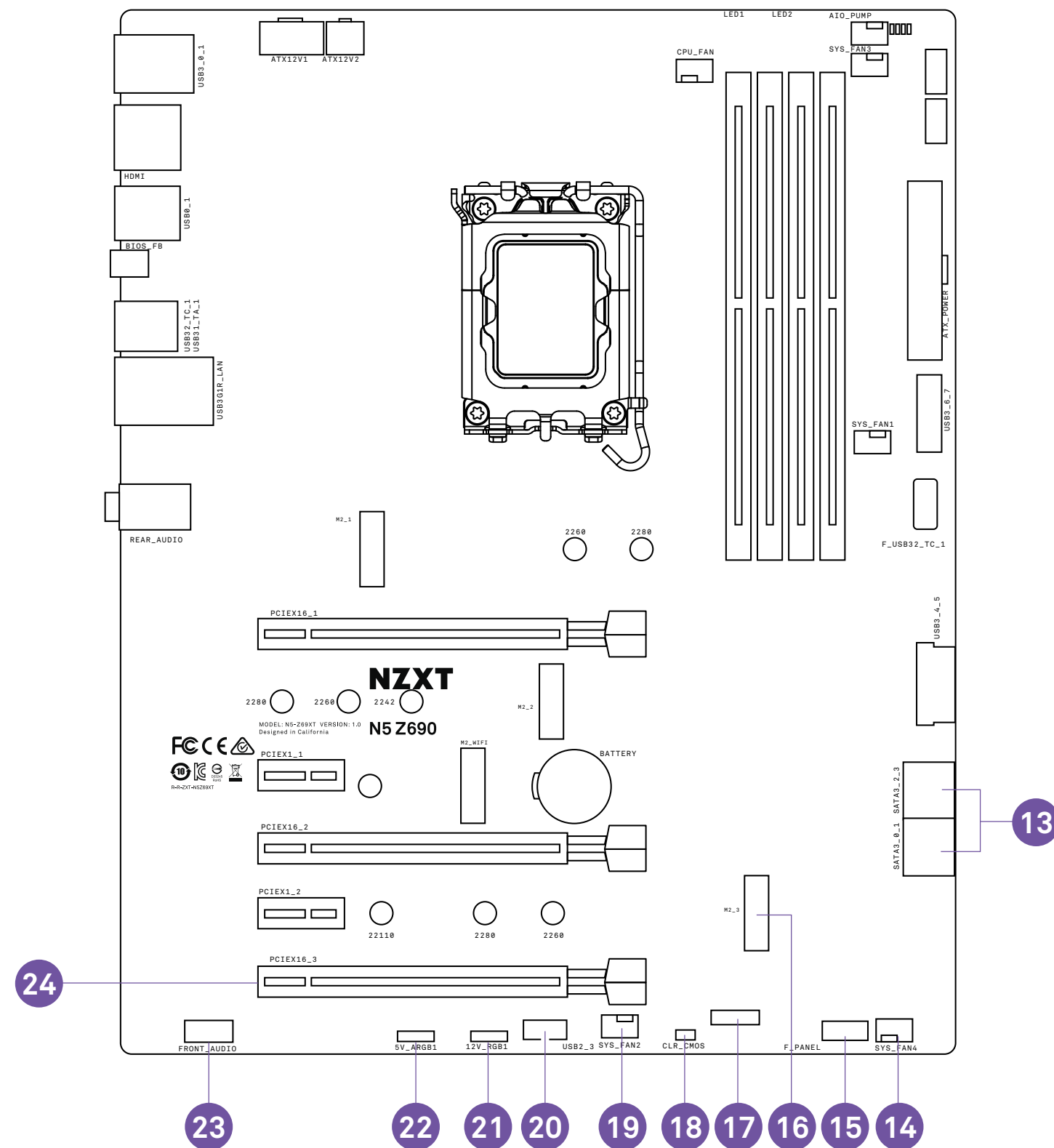

NO.	PORT NAME	DESCRIPTION
13	SATA 1-4	SATA 6Gbps 接口
14	SYS_FAN 4	4 针风扇接口
15	前面板接口	前面板开关和 LED 接口
16	M2_3	M Key M.2 插槽 3，支持 2242/2260/2280/22110 型存储设备 (支持 PCIE 和 SATA 模式)
17	SPI TPM 接头	TPM 模块接头
18	Clear CMOS 跳线	Clear CMOS 接头
19	SYS_FAN 2	4 针风扇接口
20	USB2_3	前面板 USB 2.0 接头
21	12V RGB1	4 针 12V LED 接头
22	5V ARGB1	3 针 5V LED 接头
23	FRONT_AUDIO	前面板音频接口
24	PCIEX16_3	PCI Express x16 Gen3 插槽

3.3 端口概览

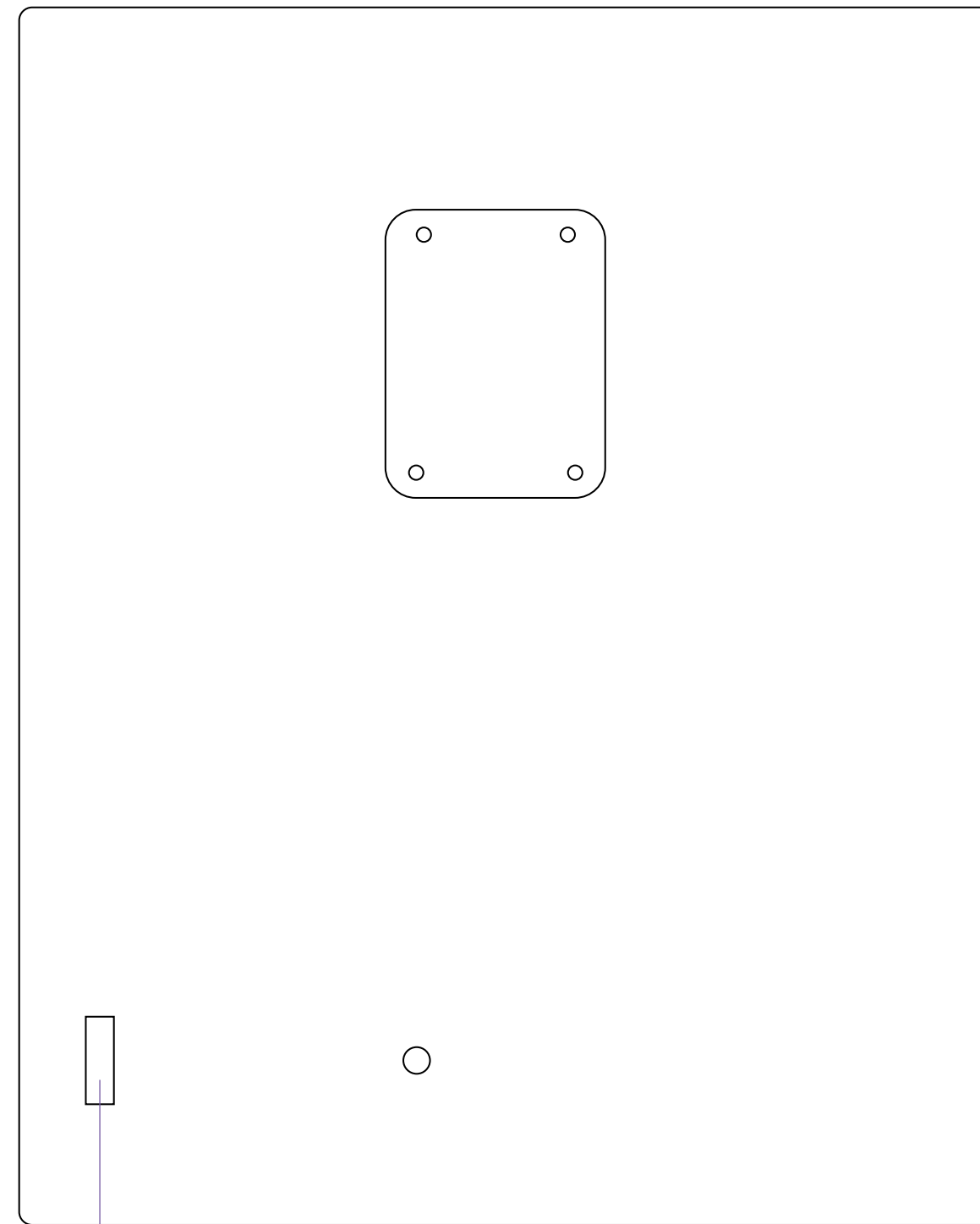
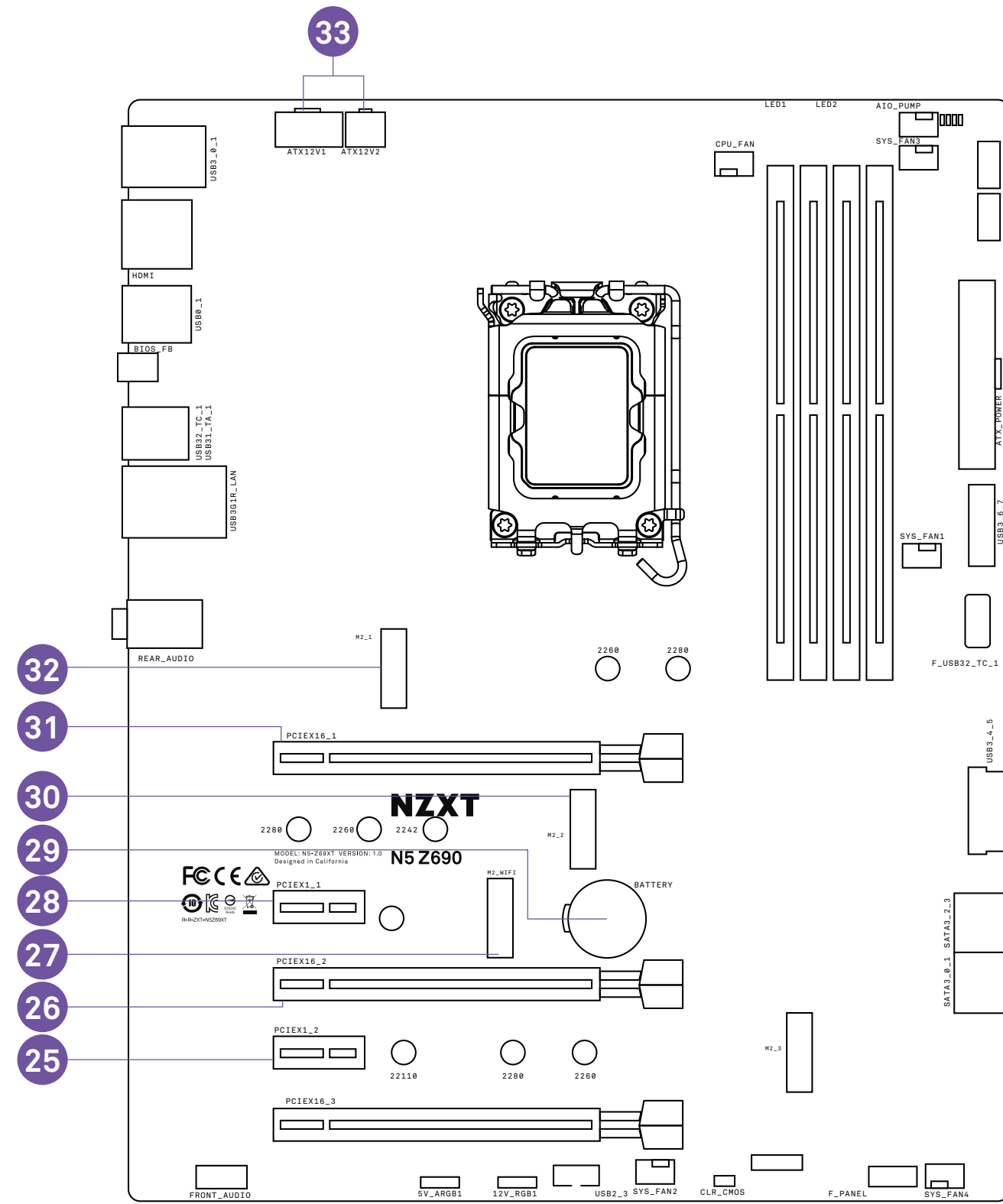

NO.	PORT NAME	DESCRIPTION
25	PCIEX1_2	PCI Express x1 Gen4 插槽
26	PCIEX16_2	PCI Express x16 Gen4 插槽
27	M2_WIFI	E Key M.2 插槽 1 · 支持具有 CNVio 接口的 2230 型无线设备
28	PCIEX1_1	PCI Express x1 Gen4 插槽
29	电池	CMOS 电池
30	M2_2	M Key M.2 插槽 3 · 支持 2242/2260/2280 型存储设备 (支持 PCIE)
31	PCIEX16_1	用于 GPU 的 PCI Express x16 Gen5 插槽
32	M2_1	M Key M.2 插槽 3 · 支持 2260/2280 型存储设备 (支持 PCIE)
33	ATX_12V	8+4 针 +12V 电源接口
34	M2_4	M Key M.2 插槽 3 · 支持 2242/2260/2280 型存储设备 (支持 PCIE)

3.3 后部 I/O

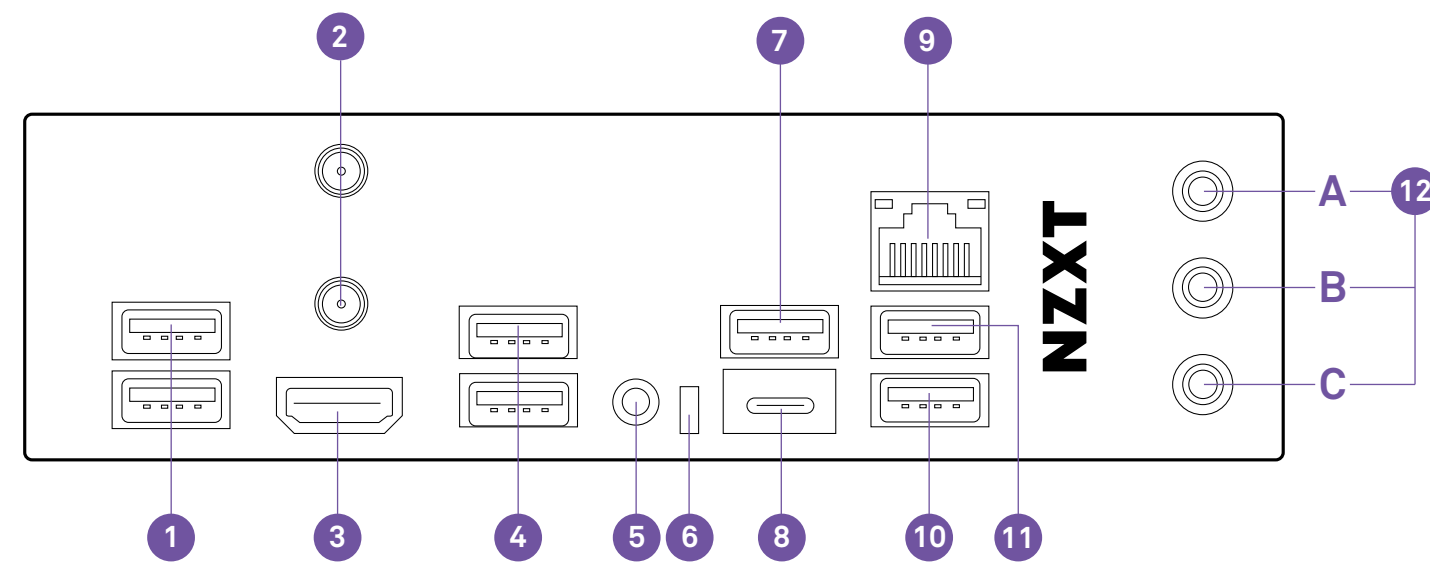

NO.	PORT NAME
1	USB 3.2 Gen 1
2	无线天线
3	HDMI 端口
4	USB 2.0
5	BIOS Flashback 按钮
6	BIOS Flashback LED
7	USB 3.2 Gen 2

NO.	PORT NAME
8	USB 3.2 Gen 2 Type-C
9	RJ45 LAN 端口
10	具有 BIOS Flashback 功能的 USB 3.2 Gen 1
11	USB 3.2 Gen 1
12	音频接口
	A. Line-in
	B. 左前和右前
	C. 麦克风

3.4 CPU 插槽



LGA 1700 CPU 表面上有四个缺口和一个金色三角形，用于辅助您将 CPU 正确放入插槽中。

注意

- 在安装或拆卸 CPU 前，务必断开电源线。
- 安装 CPU 后，请保留 CPU 保护盖。
- 开机之前，请确认 CPU 散热器已正确安装。
- 无论何时，如 CPU 尚未安装，请务必用塑料保护盖盖住 CPU 插槽，以保护插槽针脚。
- 请参阅 CPU 散热器制造商的说明安装散热器。

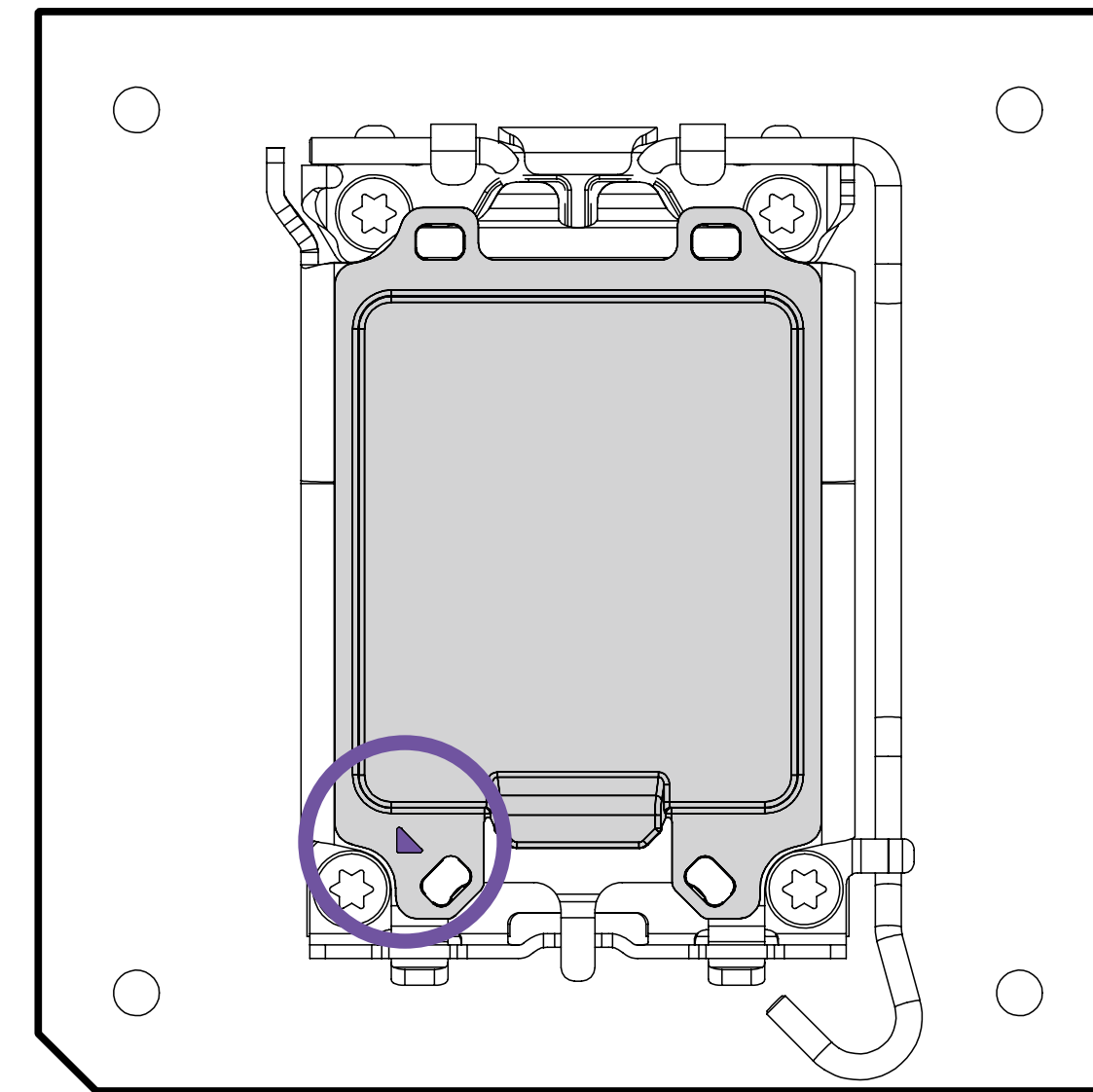

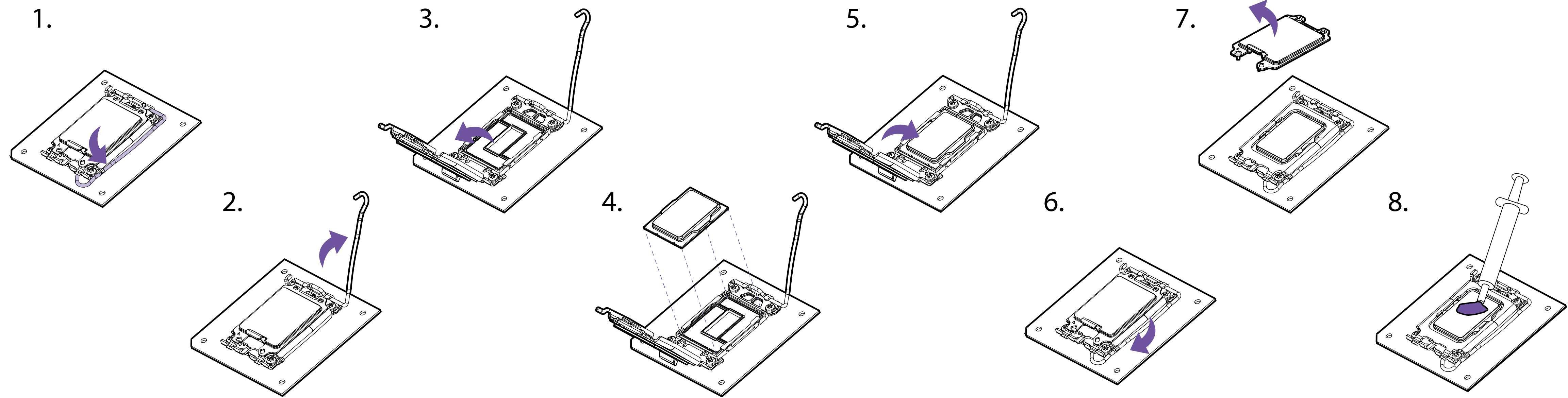
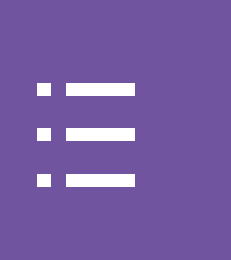

- 向下按压并向外推动固定杆，将其释放。
- 打开卡扣，放入 CPU，确保 CPU 上的三角形和缺口与指示的位置对齐。
- 合上卡扣，向下按压固定杆，将 CPU 锁定到位。
- 塑料保护盖会自动掉落。
- 根据需要涂抹导热膏并安装 CPU 散热器。

3.5 DIMM 插槽



DIMM 插槽位于此处。有关推荐内存配置，请参见图表。

⚠ 注意

- 先将内存模块插入 A2 插槽。

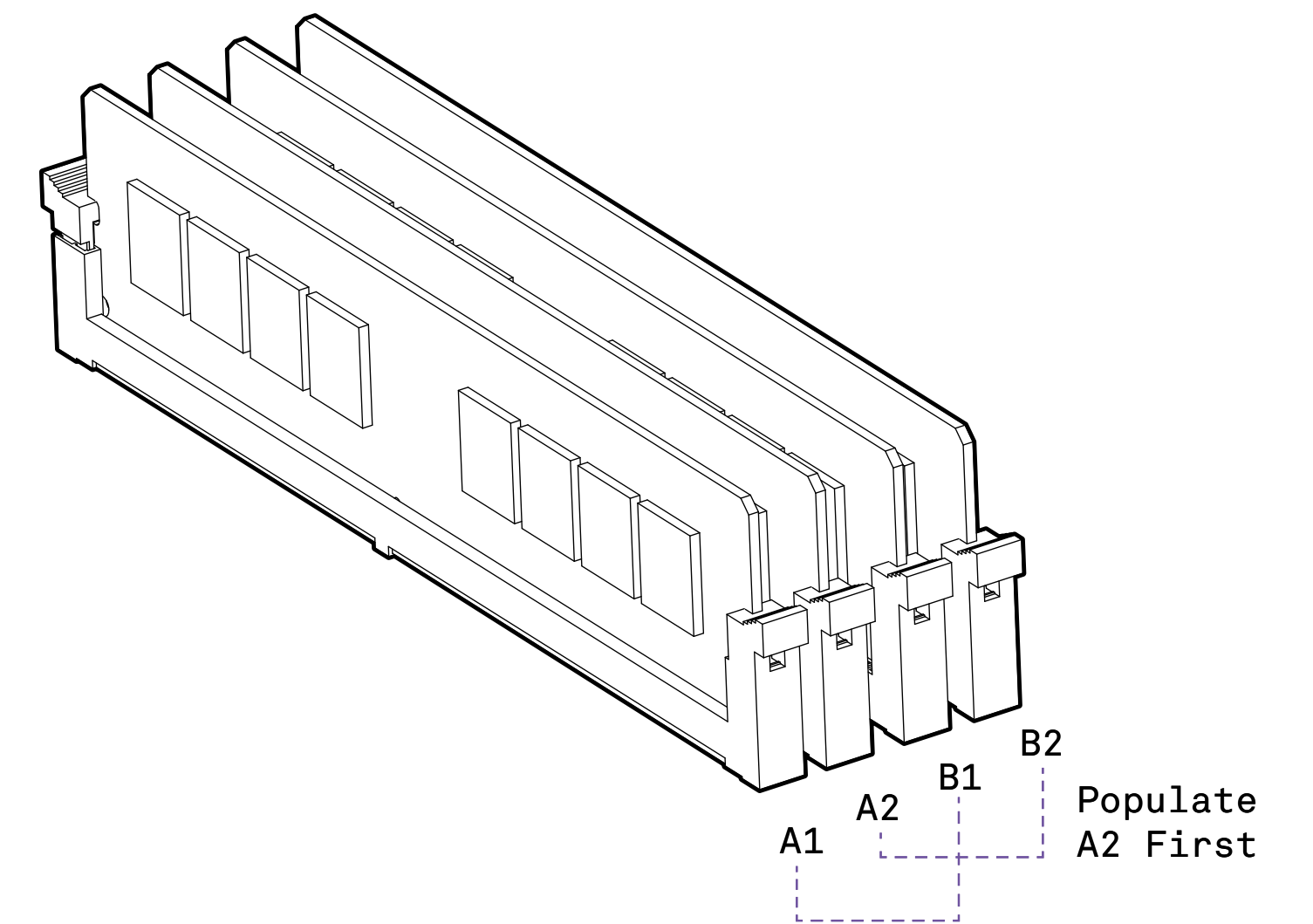
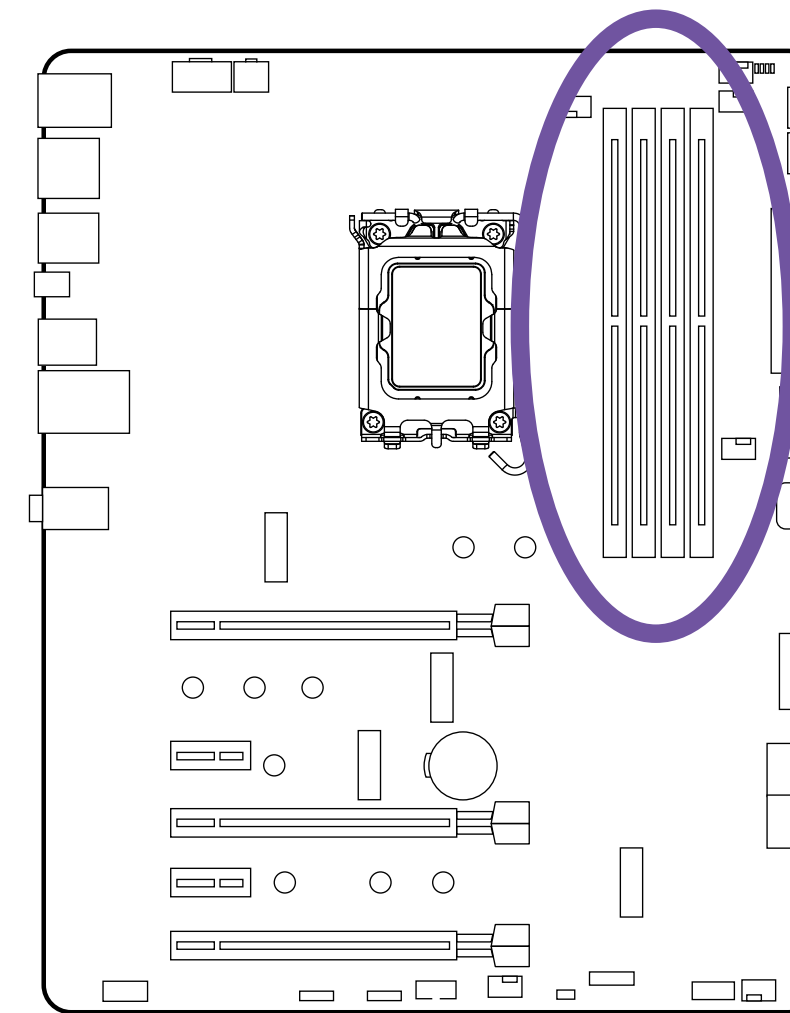

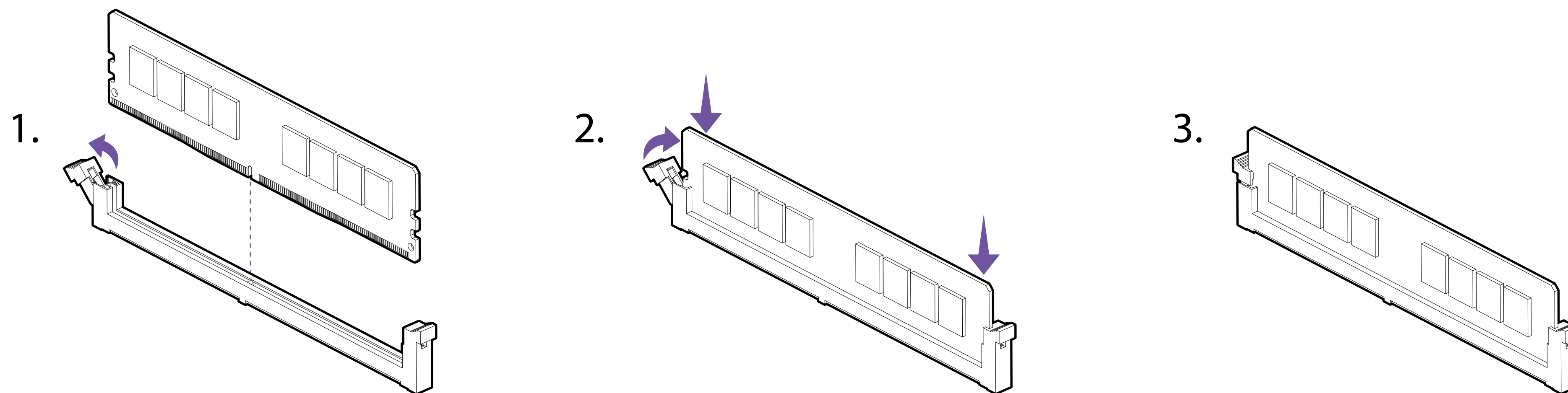
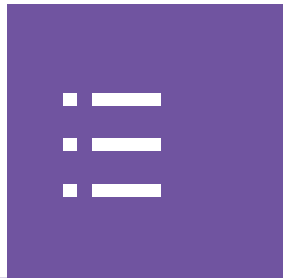

- 如图所示，推动释放杆。
- 将内存与中间的缺口对齐，并对准 DIMM 插槽。
- 用力将内存推入 DIMM 插槽，直到释放杆自动锁定。

3.6 PCI EXPRESS 扩展插槽

插槽列表请参见下图。安装显卡时，请优先使用 PCIEX16_1，然后再使用 PCIEX16_2。

⚠ 注意

- 如果只有一块 PCIe x16 显卡，请使用 PCIEX16_1。
- 加装或拆卸扩展卡时，请务必关闭电源，并将电源线从电源插座中拔出。请阅读扩展卡的说明文档，查看是否需要对硬件和软件进行其他必要的更改。

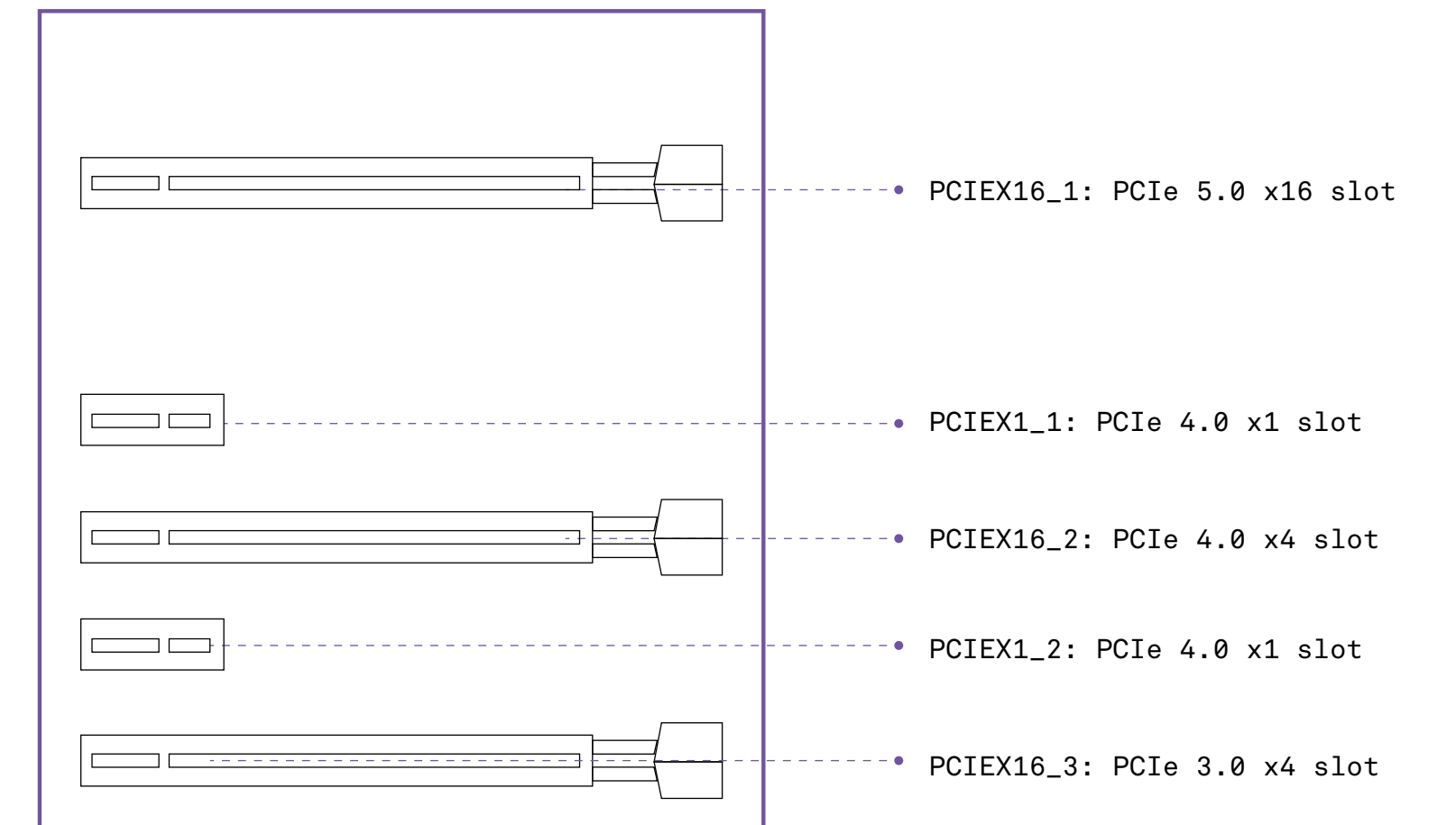
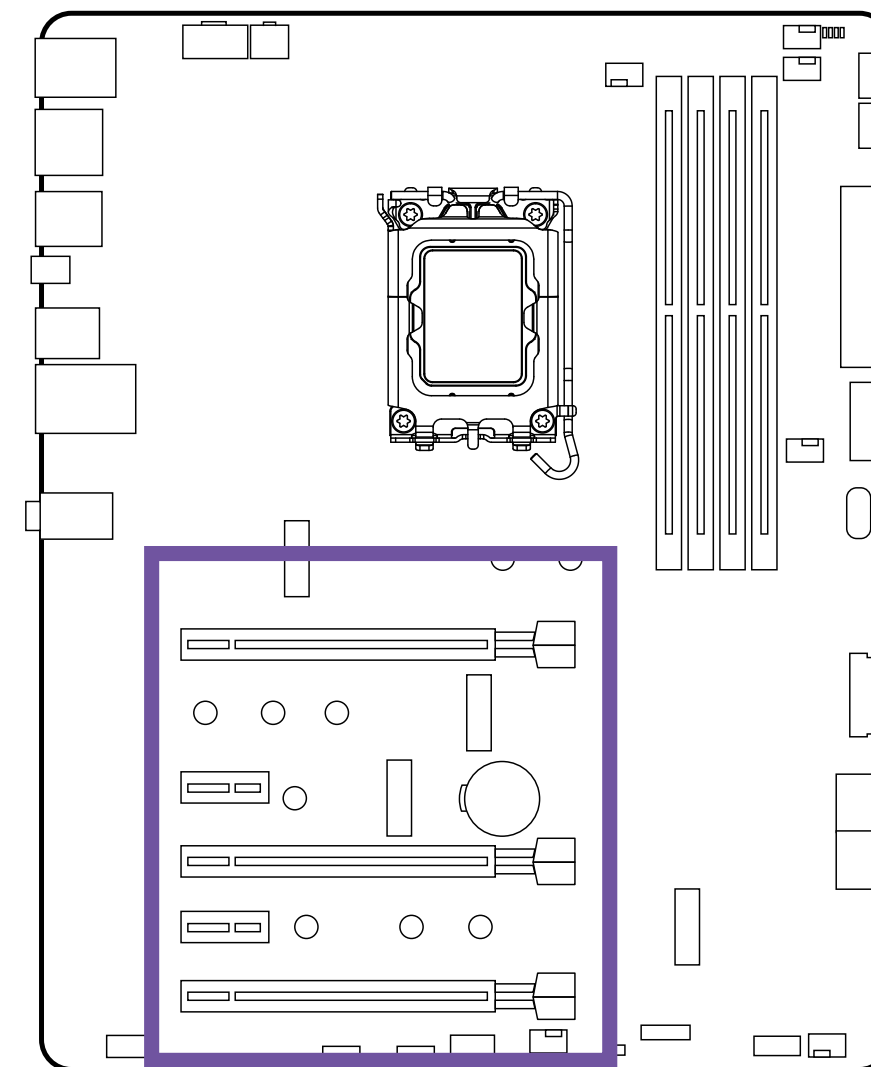



有关多显卡配置的供电建议，请参阅显卡用户指南，确保您满足所有系统要求。

安装多块显卡：

- 关闭计算机并断开电源线，将两块显卡安装到 PCIEX16_1 和 PCIEX16_2 插槽中。
- 连接显卡的所有 PCIe 电源接口。
- 重新连接电源线，打开计算机电源，然后安装显卡包装中附带的驱动程序和软件。

3.7 SATA 接口



这些接口为 SATA 6Gb/s 接口。每个接口均可连接一个 SATA 设备。没有接口使用与任何 M.2 相同的带宽。

⚠ 注意

- 请勿 90 度弯折 SATA 线。这可能导致传输过程中的数据丢失。
- SATA 线两侧的插头完全相同。但是建议将平头插头连接到主板，以便节省空间。

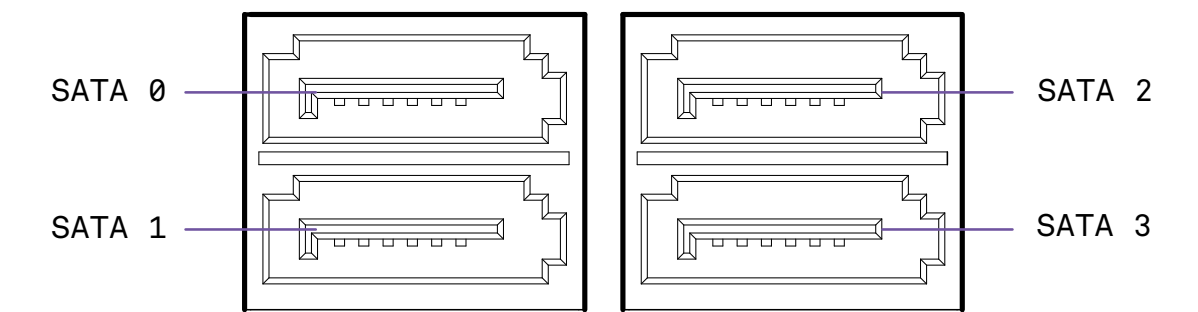
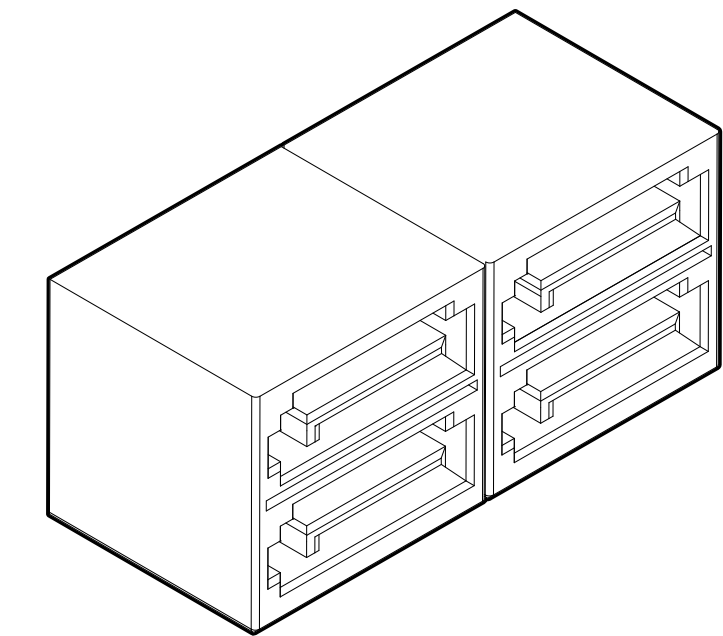
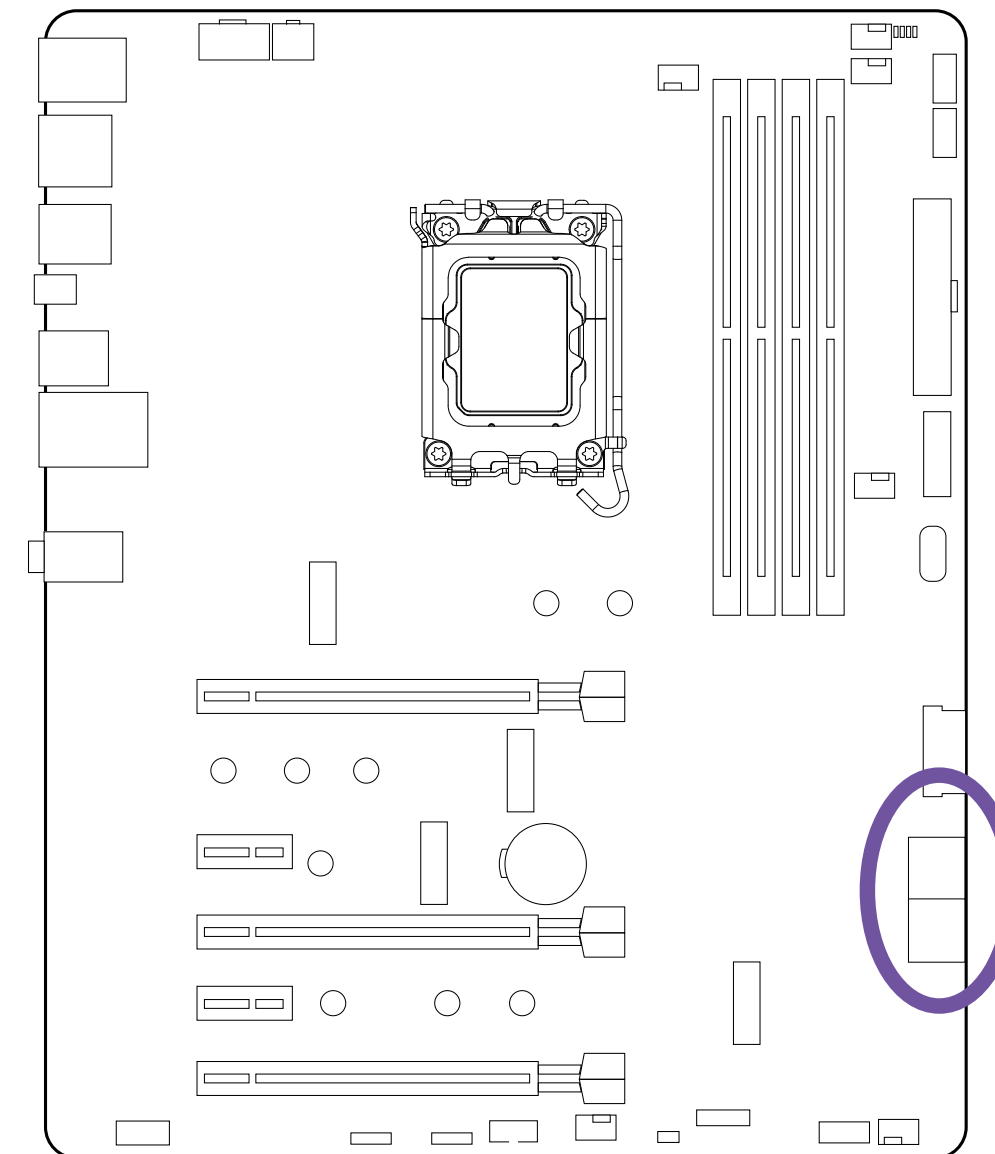

3.8 M.2 硬盘插槽



N5 主板上有 4 个 M.2 插槽。您需要在安装前取下钢制外板。最上面的插槽有一个散热器。请按照以下说明安装您的 M.2 硬盘。

注意

- 支持 Intel® Volume Management Device、Intel® Optane 内存技术和 NVMe SSD 作为启动盘。

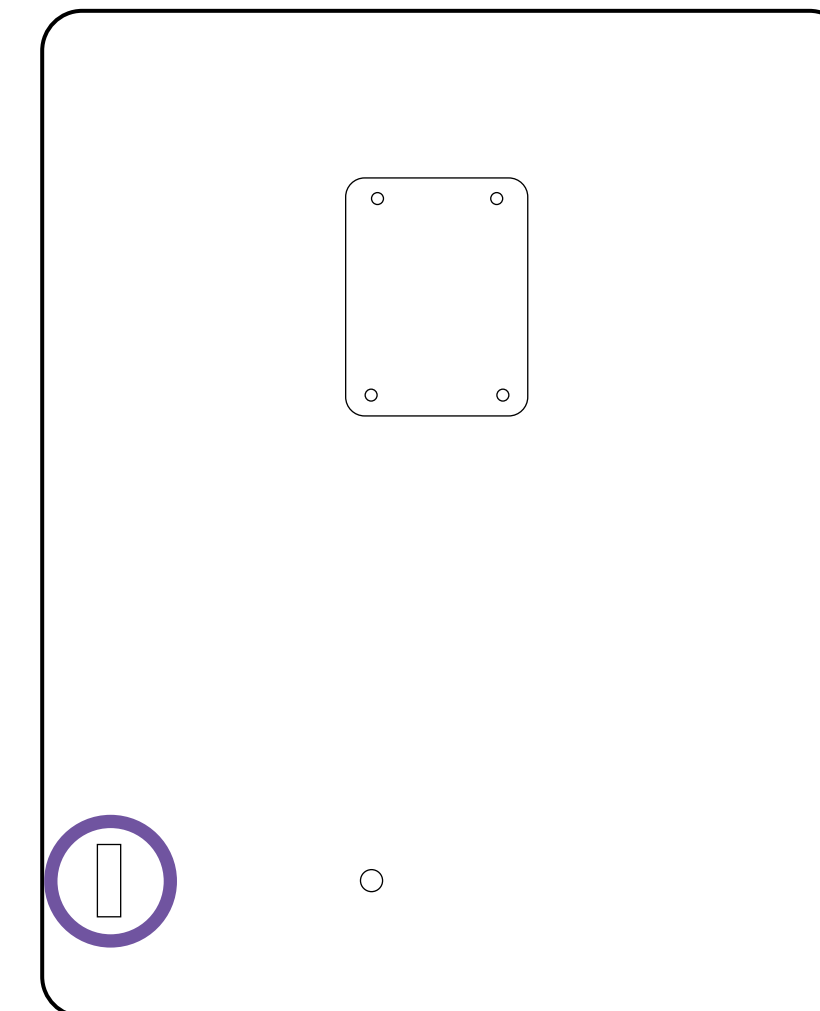
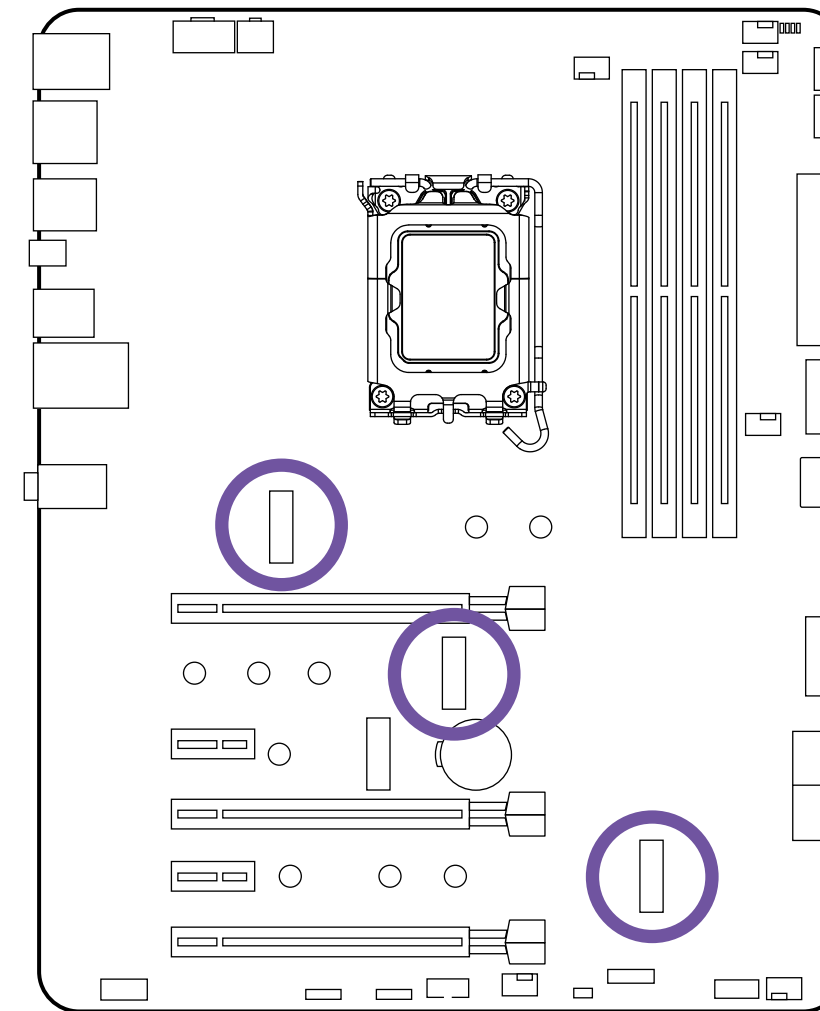

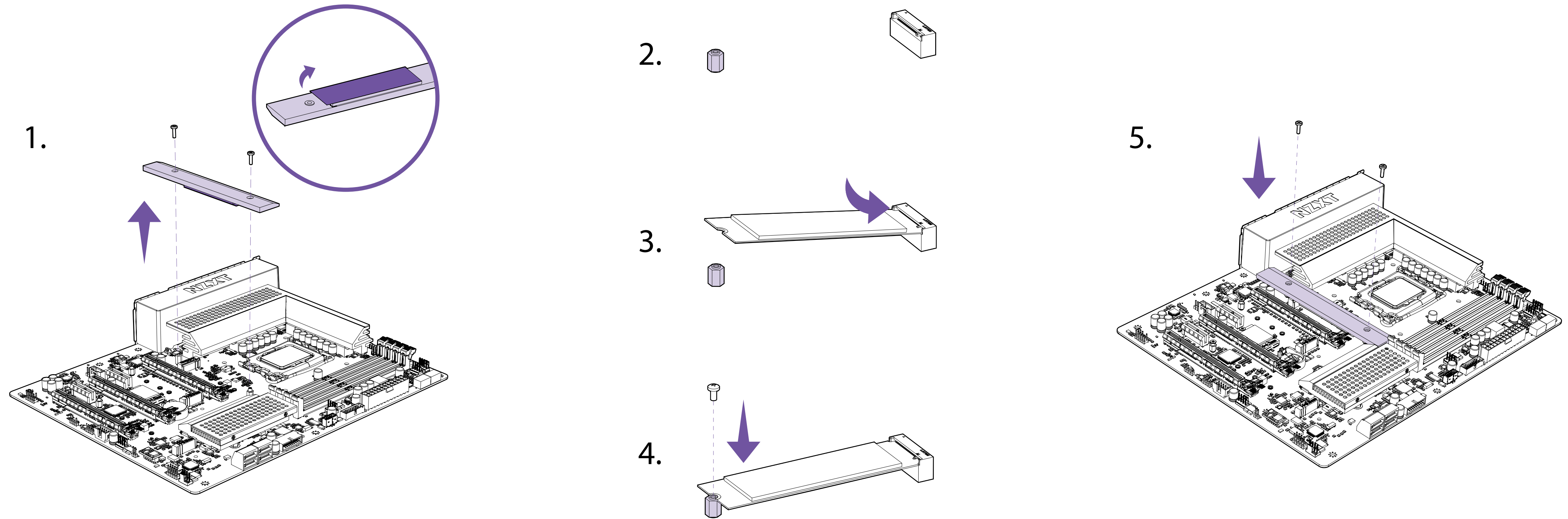

- 取下 M.2 插槽盖。
- 确认螺丝柱处于所需位置，如有必要可移动螺丝柱。
- 将 M.2 固态硬盘以一定角度插入 M.2 插槽。
- 使用 M.2 螺丝将 M.2 驱动器固定到螺丝柱上并拧紧。

3.9 M.2 插槽无线连接



支持 PCIe 和 CNVio 的 E 键 M.2 插槽位于主板中央。该插槽预装了一张无线网卡和两根天线电缆，将无线信号传输到后部 I/O。

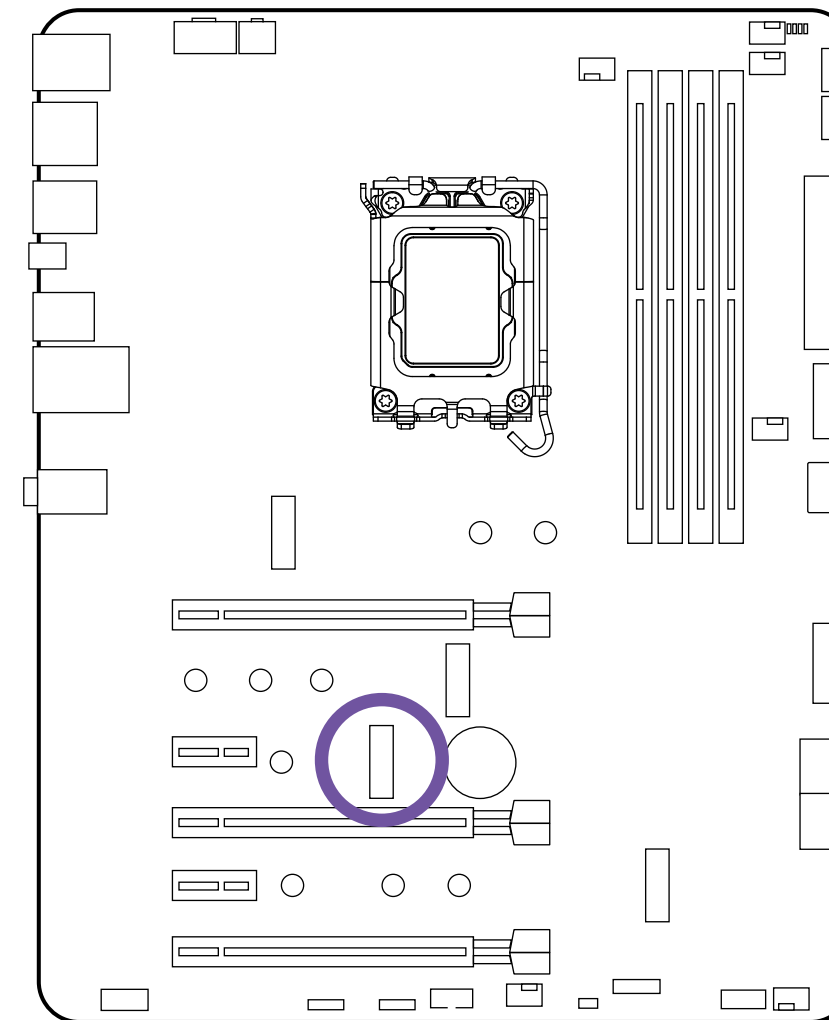

3.10 天线

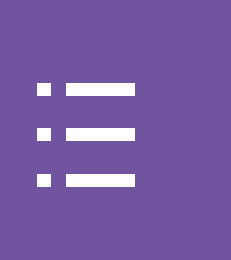

随附无线天线，用于增强无线和蓝牙信号。

- 将天线直接安装到后部 I/O 上标有“Wi-Fi”的 SMA 端口上。

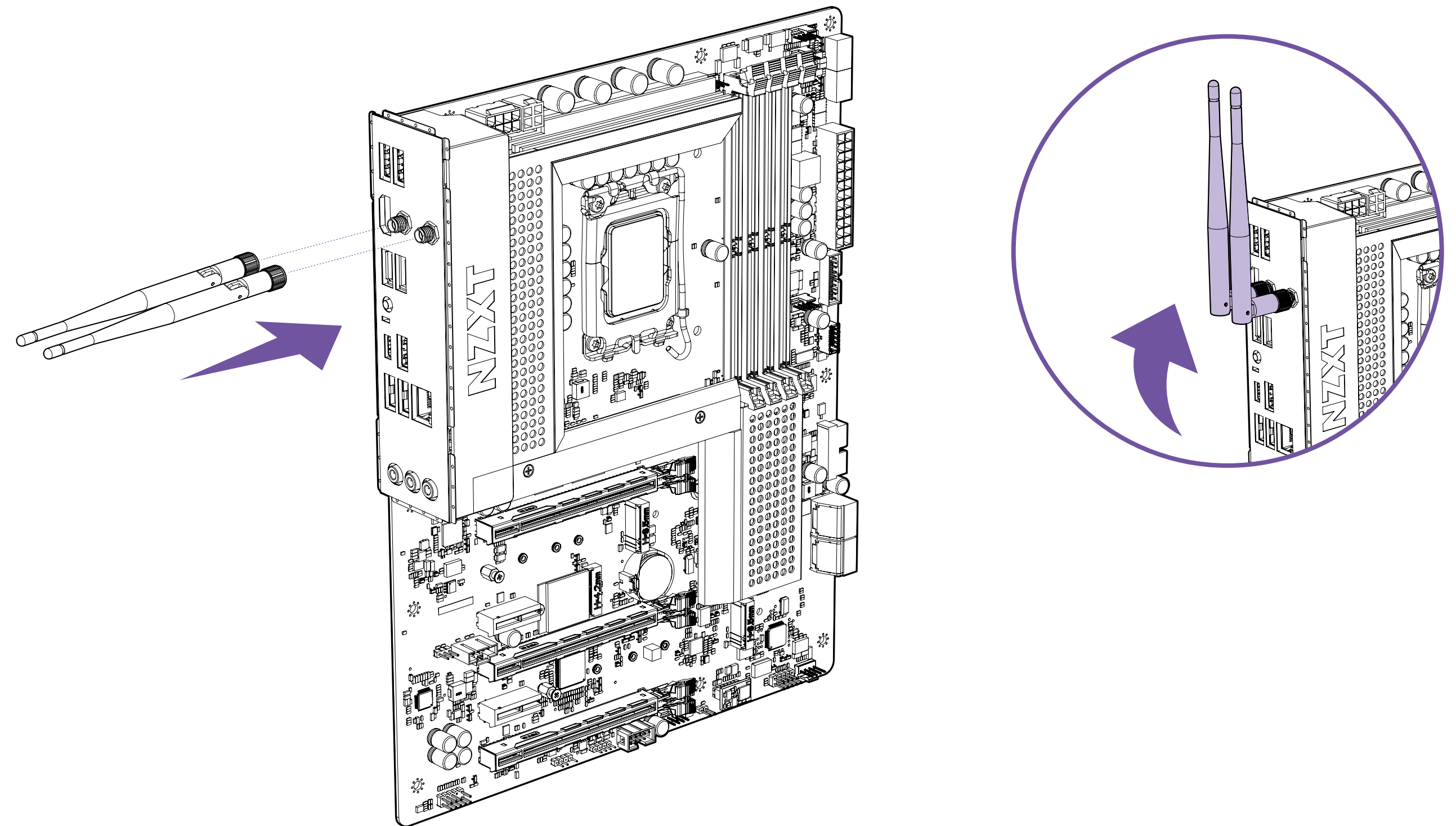

3.11 电源接口



这些接口连接 ATX 电源。

⚠ 注意

- 确保所有电源线均已牢固连接至正确的 ATX 电源，以保证主板稳定运行。

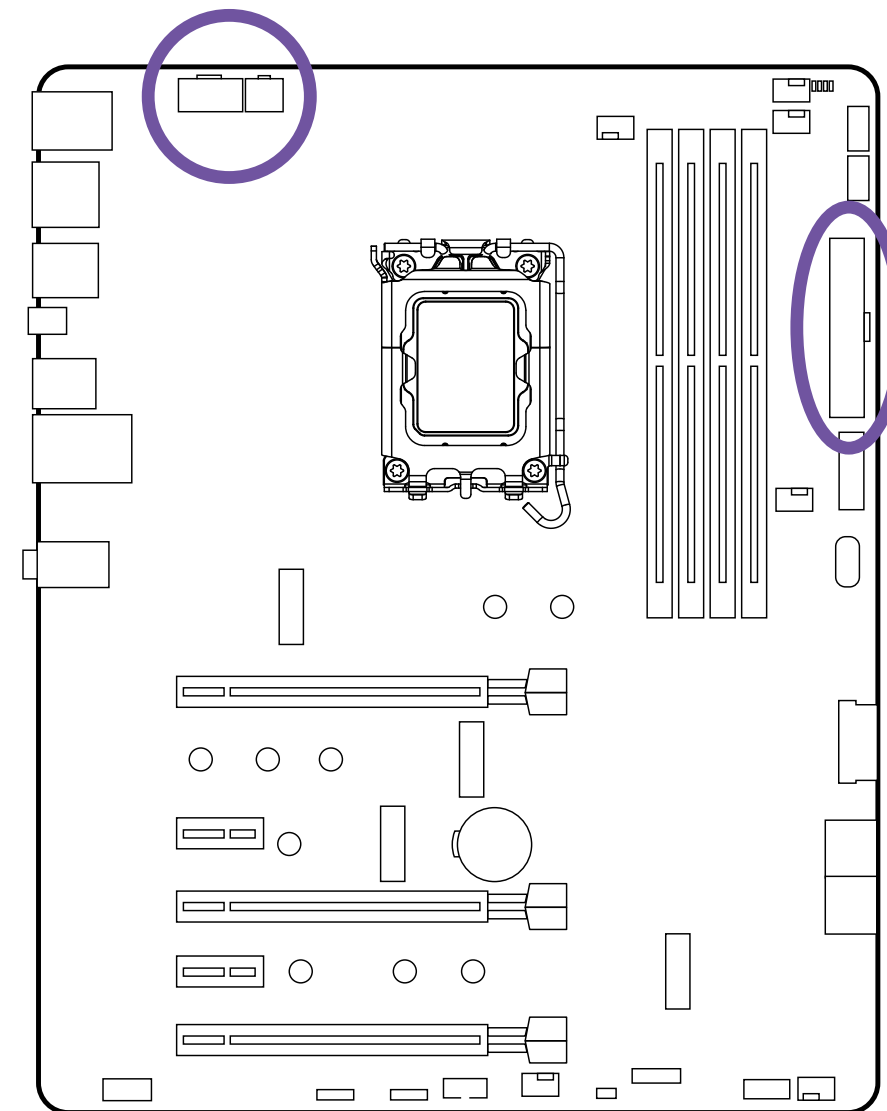

8+4-pin ATX_12V

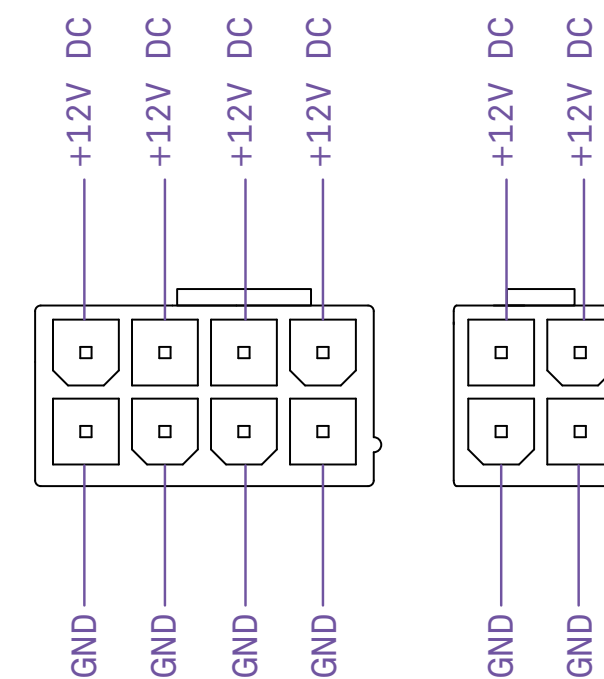

24-pin ATX_POWER

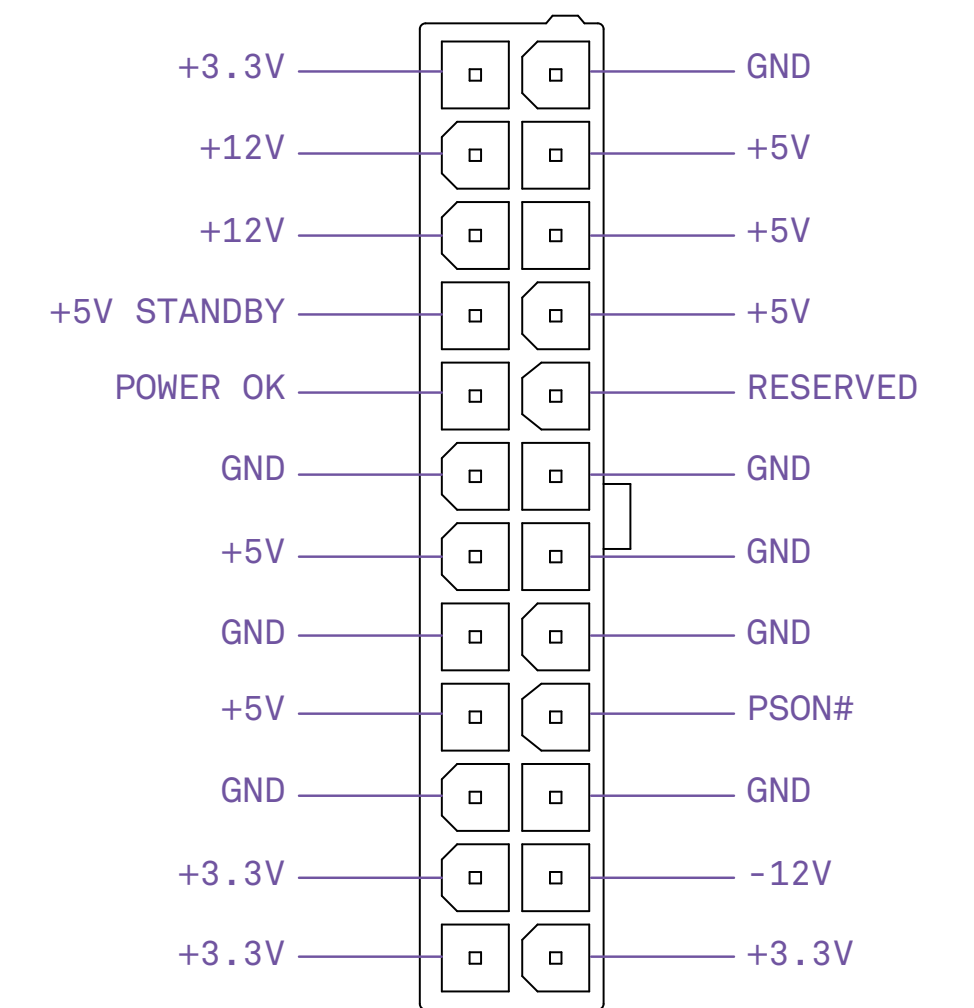

3.12 USB 接口

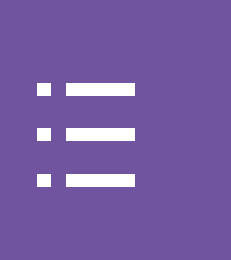

这些接口可连接前面板 USB 端口或需要内部 USB 端口的设备。

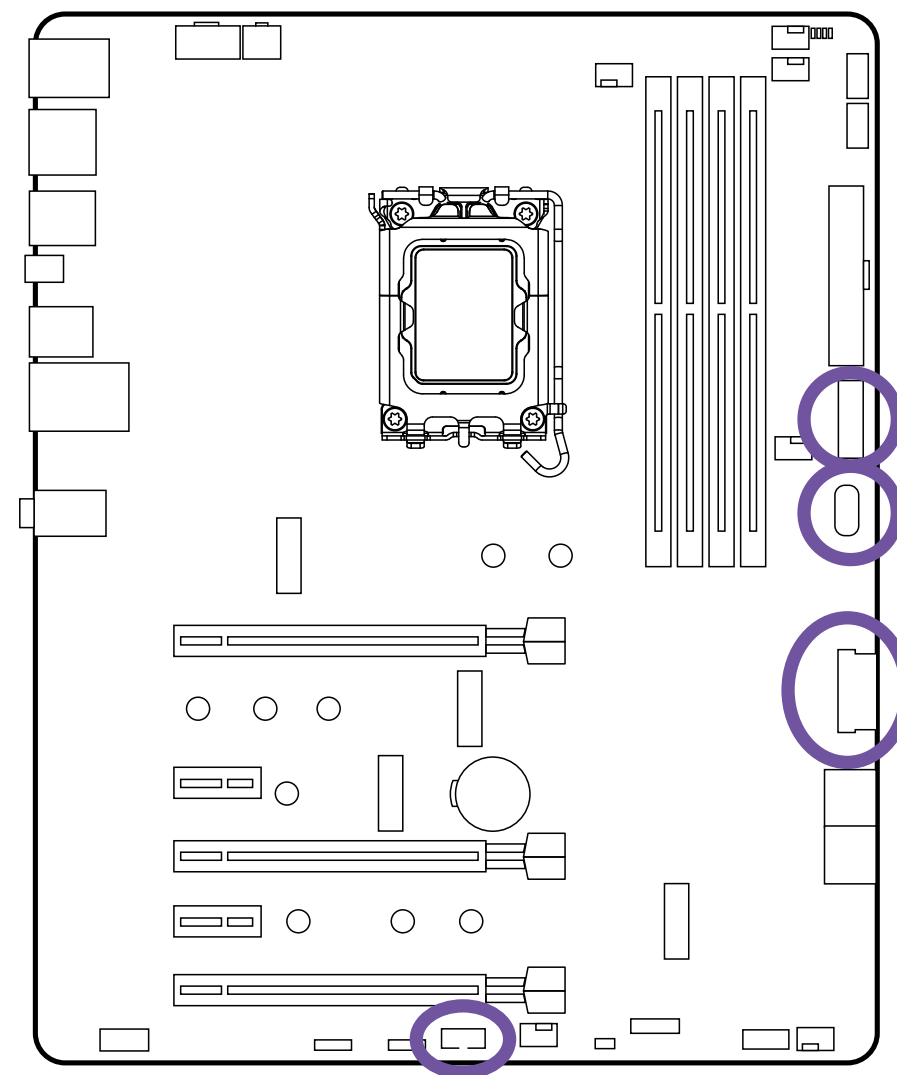

USB 2.0

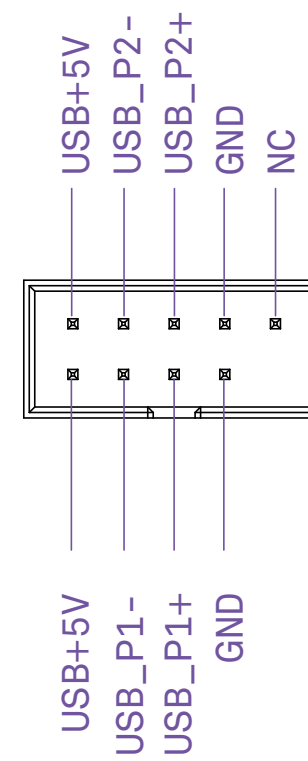

USB 3.2 Gen 1

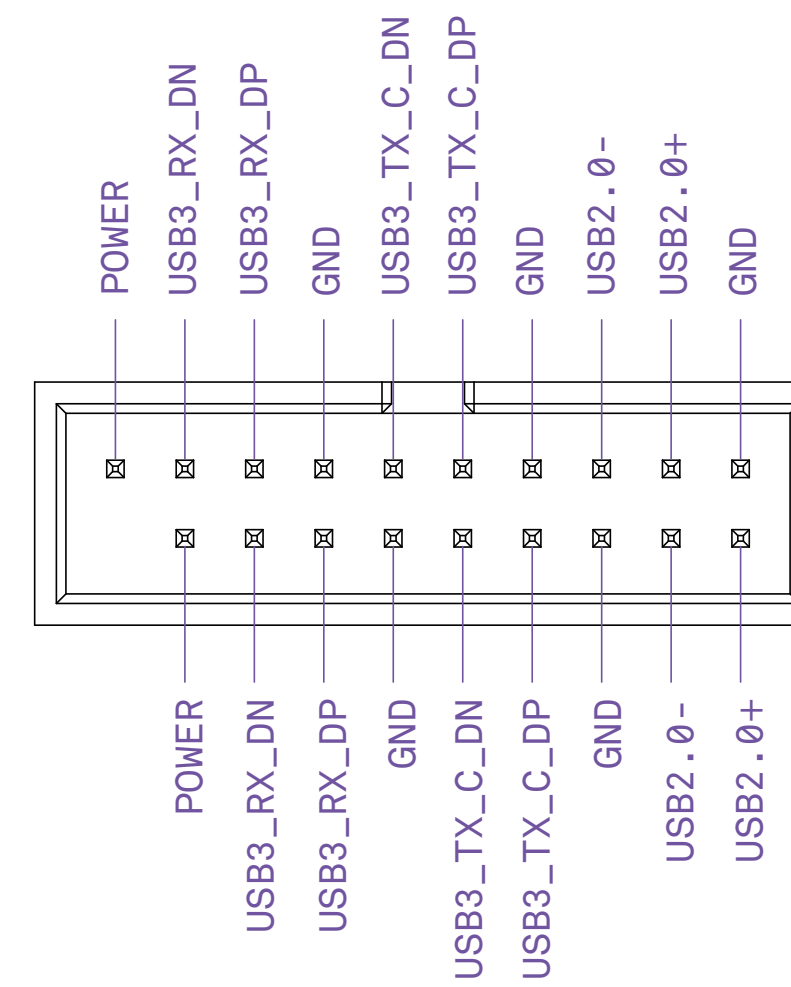

USB 3.2 Gen 2x2 Type-C

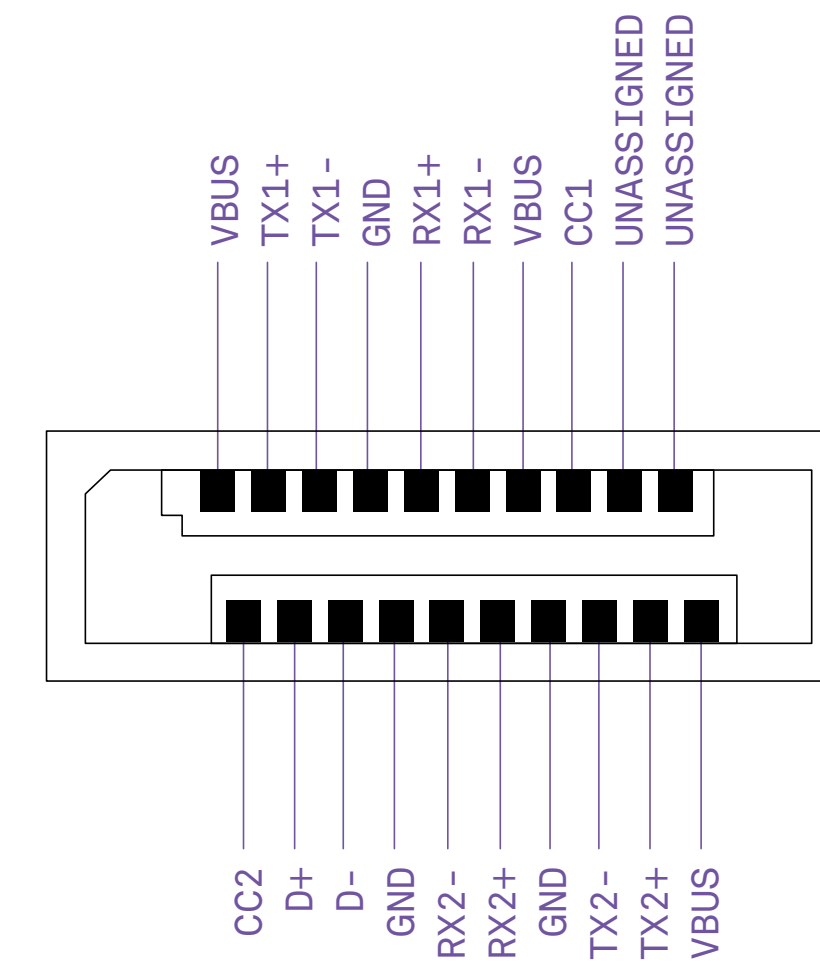

3.13 前面板音频接口



此接口连接机箱上的前面板音频接口。

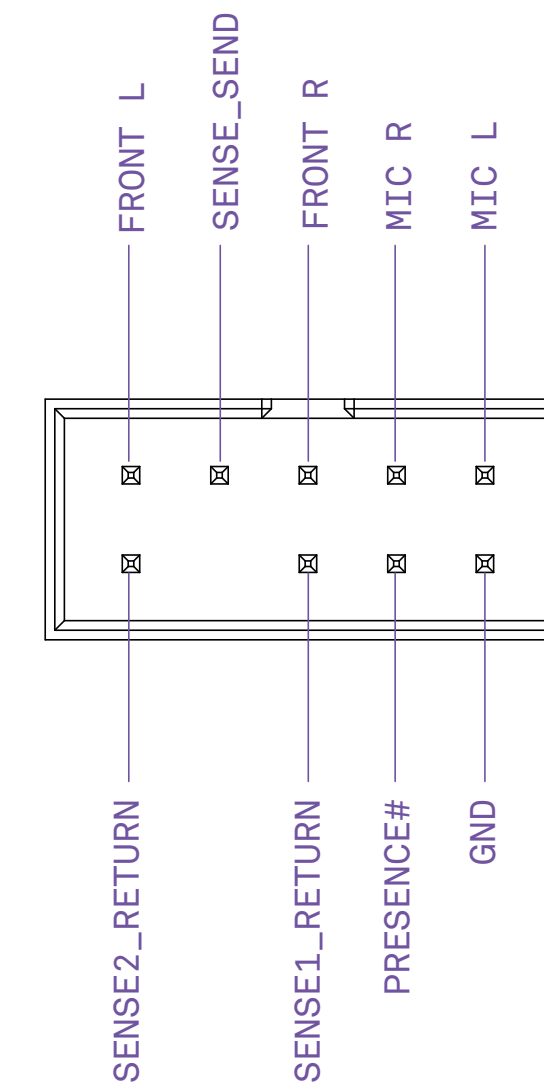
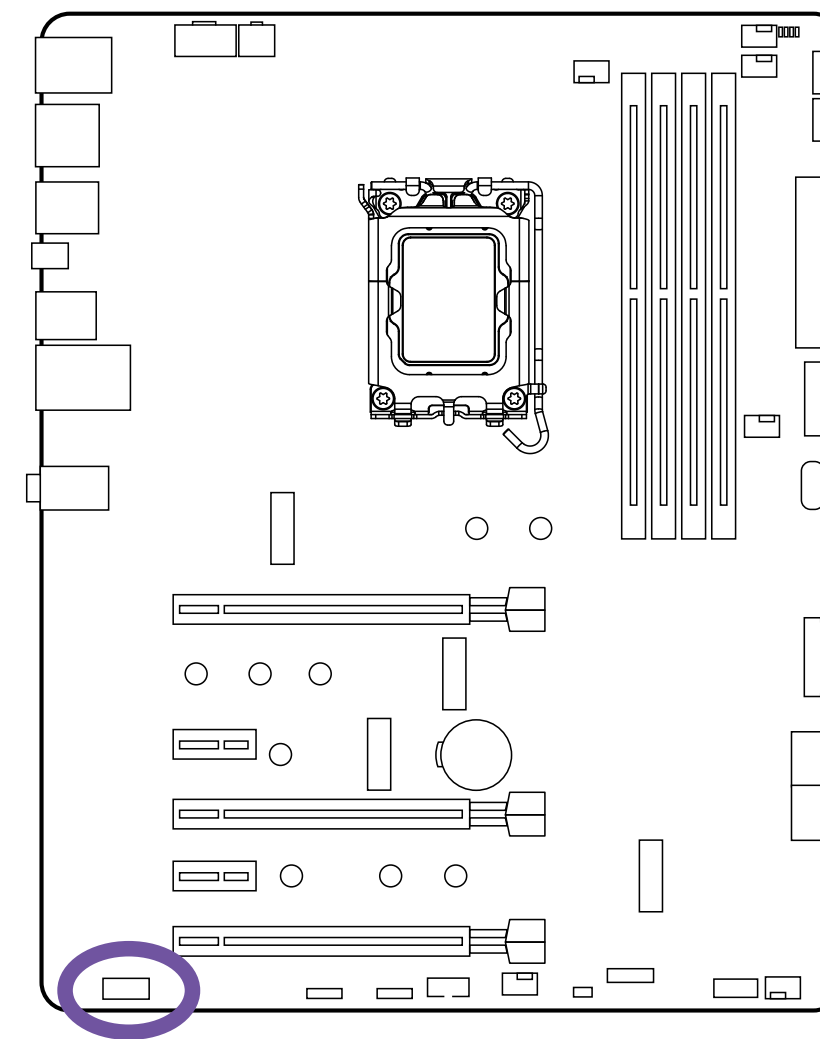

3.14 前面板接口



这些接口连接机箱上的开关和 LED 指示灯。

⚠ 注意

- 请检查针脚的极性以确保 LED 正常工作。

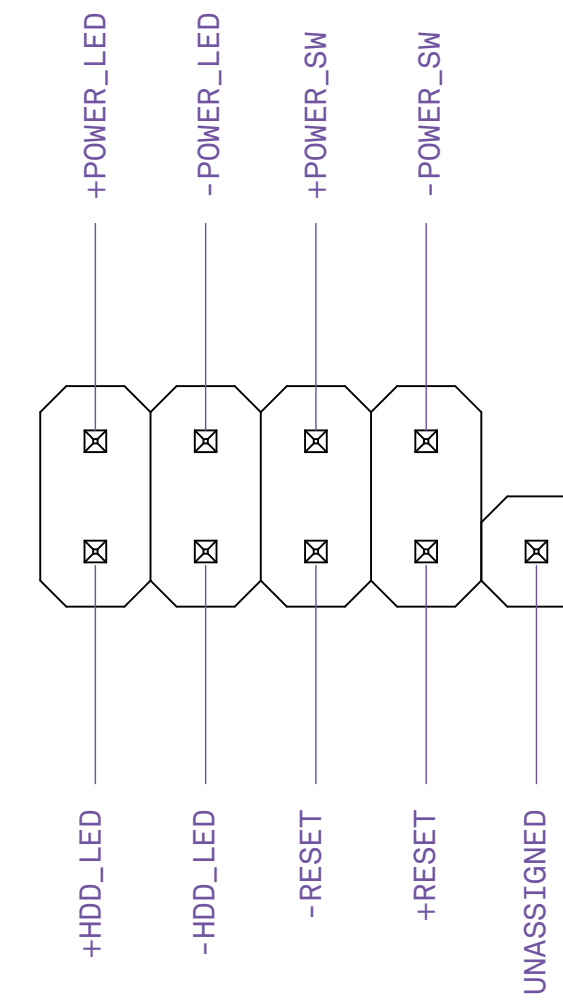
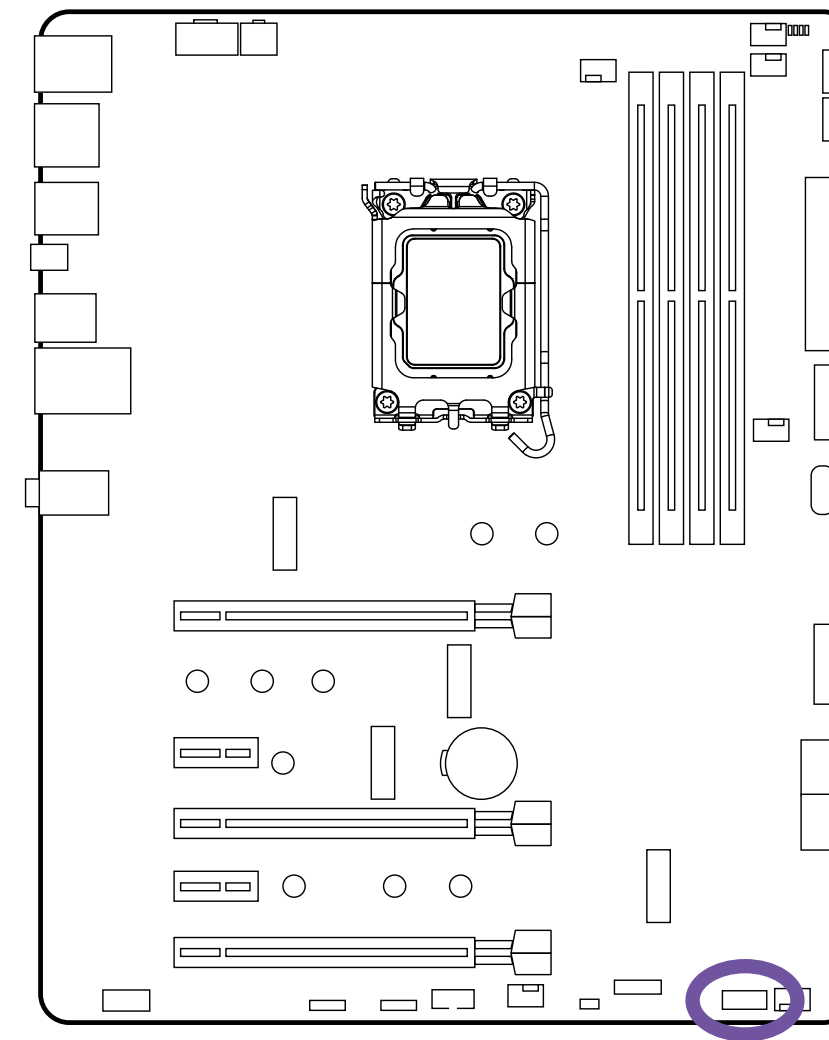

3.15 风扇接口

CPU_FAN、AIO_PUMP 和 4 个 SYS_FAN 接口会自动检测 4 针 PWM (脉冲宽度调制) 或 3 针风扇是否正在使用中，且支持的单个最大功率为 2A(24W)。风扇转速可在 CAM 中调节。

⚠ 注意

- Windows 中需要使用 CAM 控制风扇。

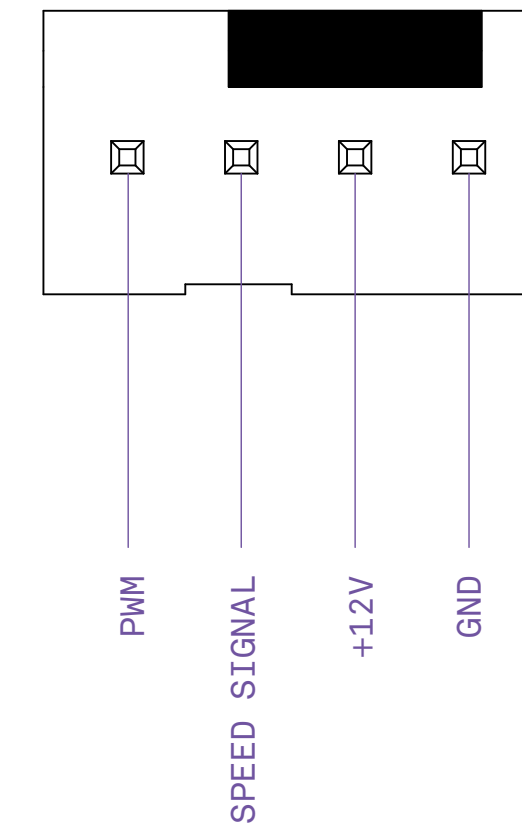
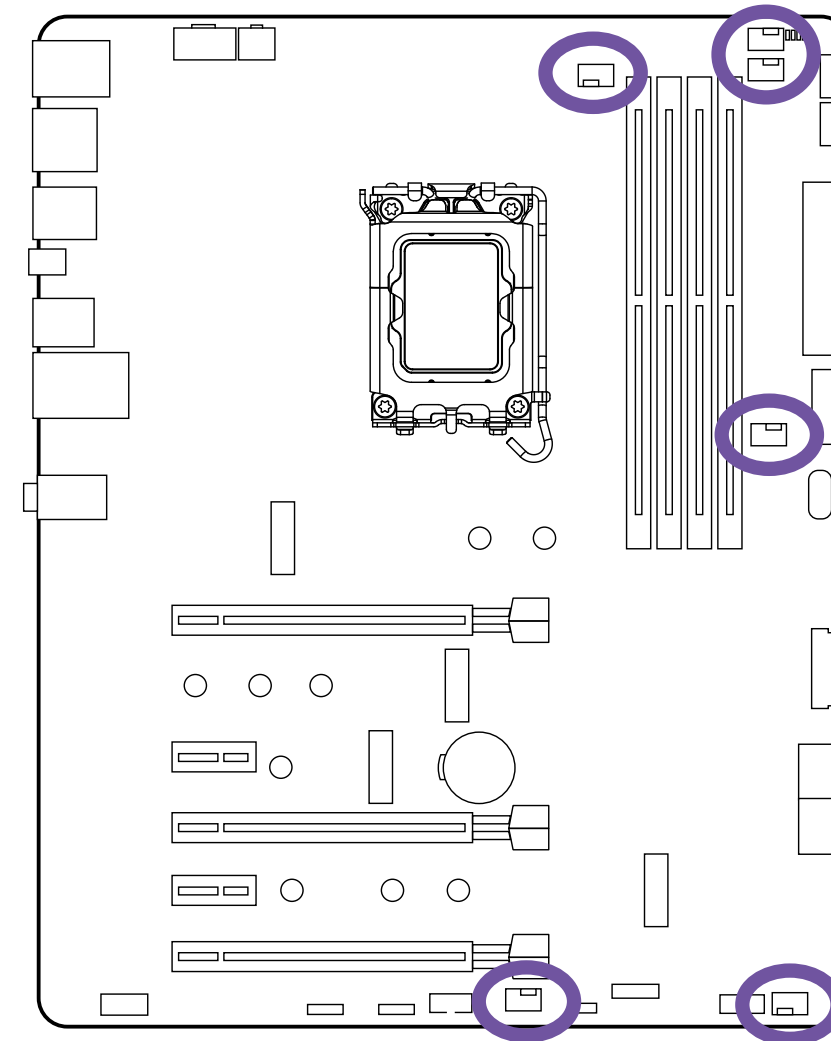

3.16 NZXT RGB 接口



主板上有两个 NZXT RGB 接头。NZXT RGB 端口兼容 NZXT 灯饰配件。每个通道最多支持 40 个 LED 和 6 个配件。

注意

- Windows 中需要使用 CAM 控制灯饰。
- 安装或拆卸灯饰配件前，请关闭系统电源，并将电源线从电源中拔出。

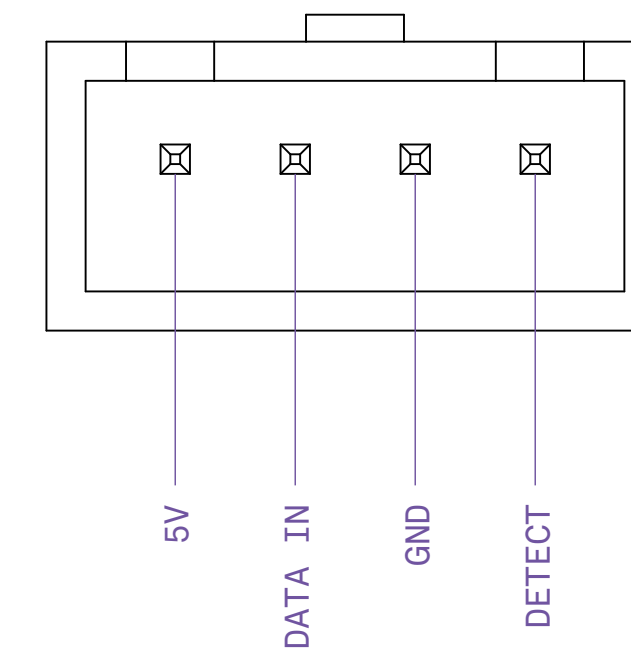
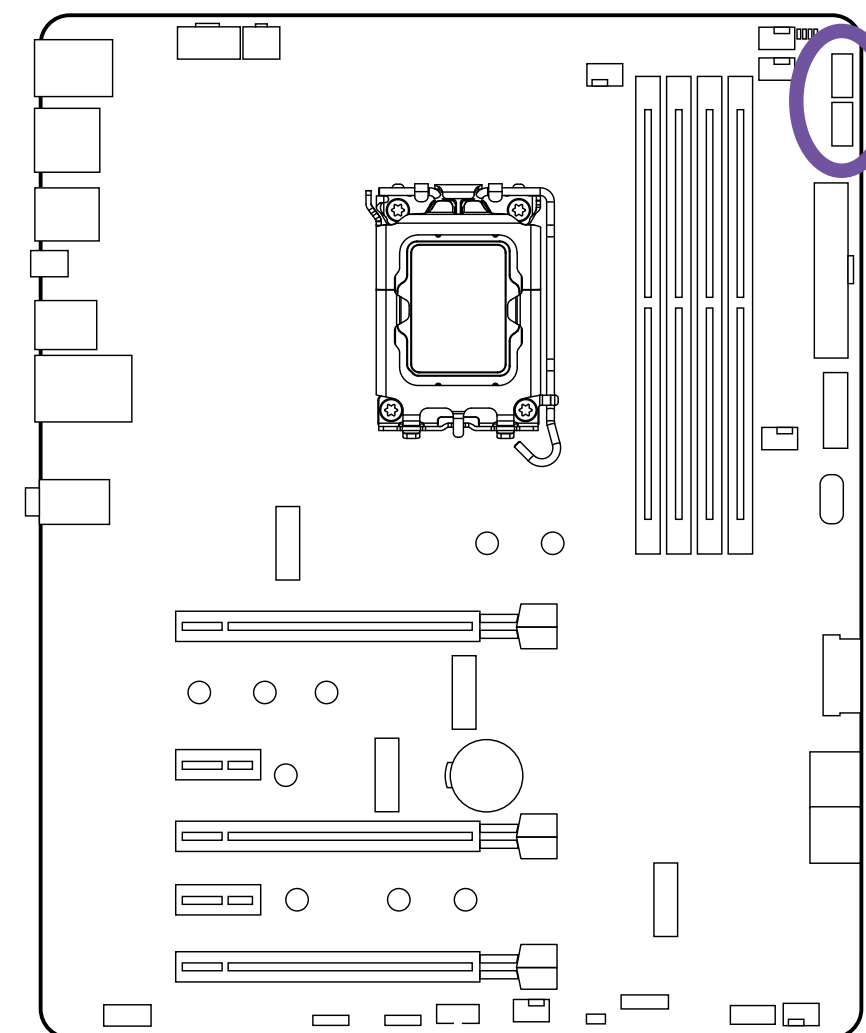

3.17 5V 可寻址 RGB 接口



主板上有一个 5V 可寻址 RGB 接口。此接口支持 WS2812B 可寻址 RGB LED 灯条 (5V/Data/GND)，最大额定功率 3A (5V)，最多支持 40 个 LED。

注意

- 安装 RGB LED 线缆时切勿弄错方向，否则会损坏主板和灯饰配件。
- Windows 中需要使用 CAM 控制灯饰。
- 安装或拆卸灯饰配件前，请关闭系统电源，并将电源线从电源中拔出。

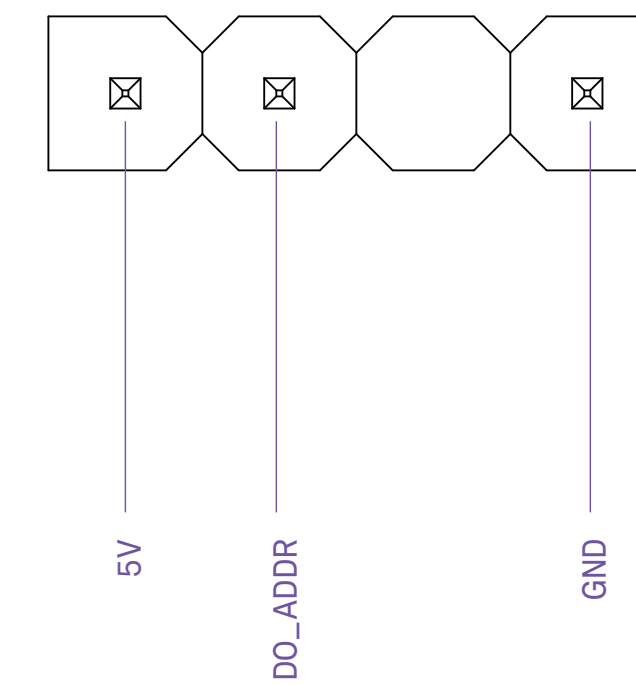
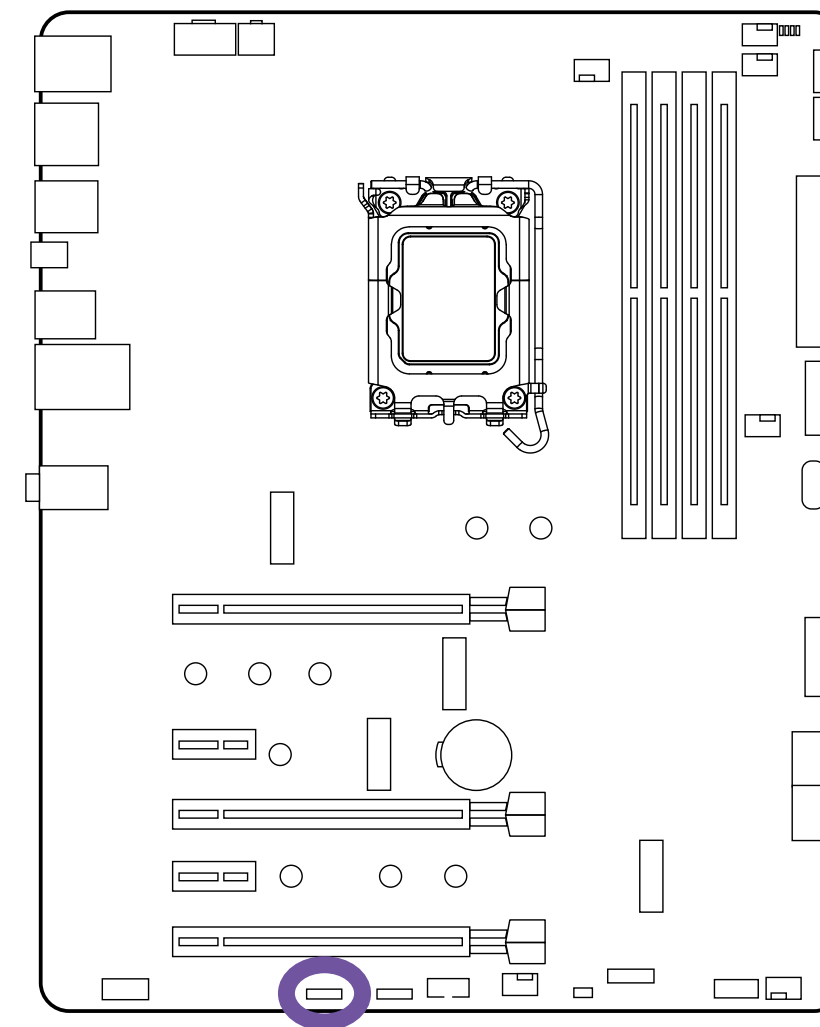

3.18 12V RGB 接口



主板上有一个 12V RGB 接口。此接口支持标准 5050 RGB LED 灯条 (12V/G/R/B)，最大额定功率 3A (12V)，长度不超过 2 米。

注意

- 安装 RGB LED 线缆时切勿弄错方向，否则会损坏主板和灯饰配件。
- Windows 中需要使用 CAM 控制灯饰。
- 安装或拆卸灯饰配件前，请关闭系统电源，并将电源线从电源中拔出。

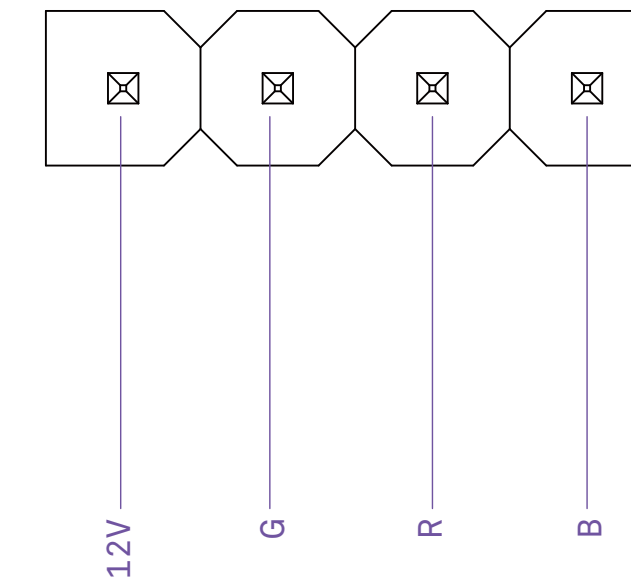
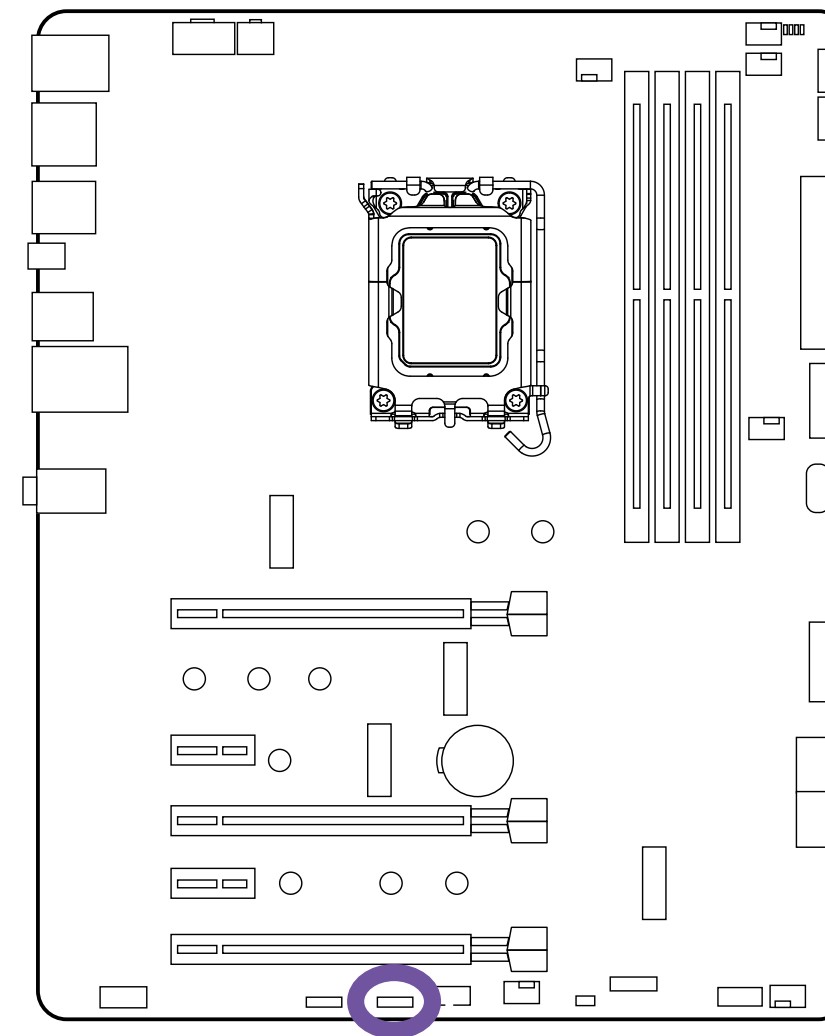

3.19 SPI TPM 接头



该接口支持 SPI 可信平台模块 (TPM) 系统，该系统可以安全存储密钥、数字证书、密码和数据。TPM 系统还有助于加强网络安全，保护数字身份，同时确保平台的完整性。

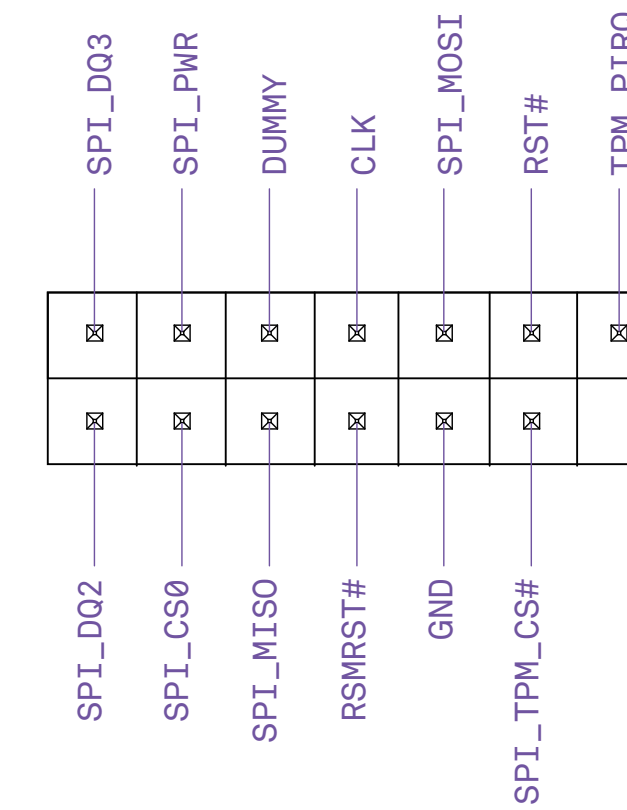
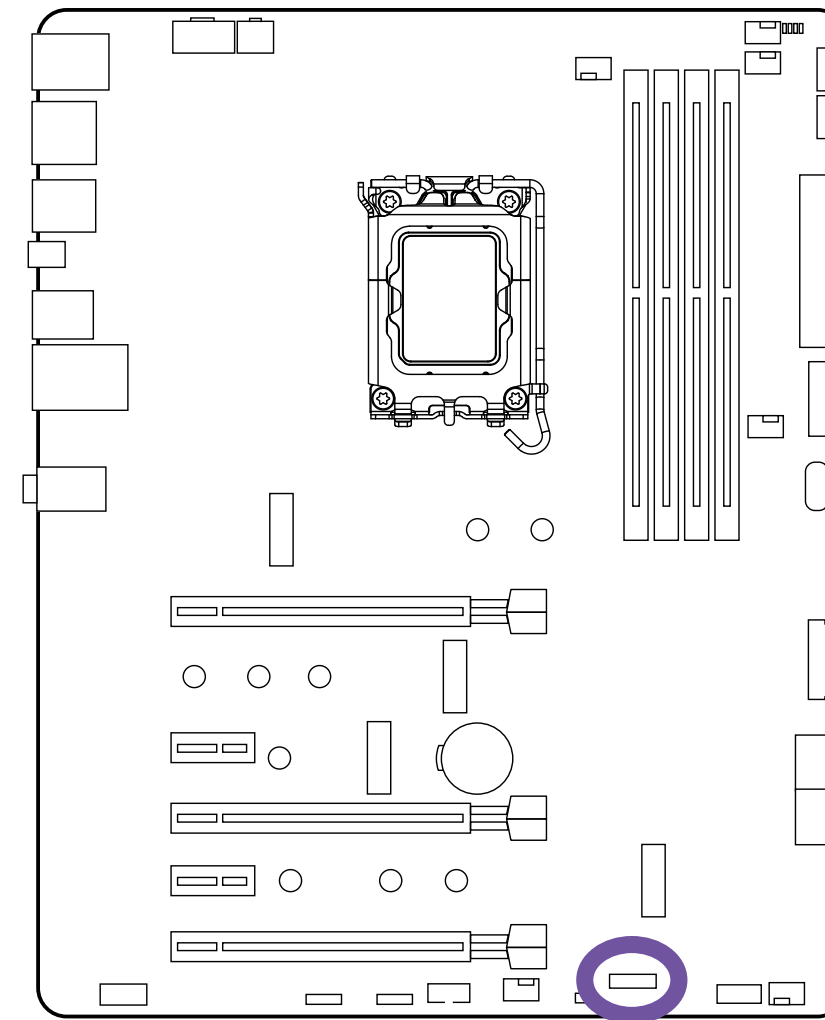

3.20 CLEAR CMOS 接头



Clear CMOS 接头

Clear CMOS 接头位于主板底部，可用于将 BIOS 设置恢复为默认值。要清除 CMOS，请关闭电源并断开电源的交流电源。等待 30 秒，确保没有待机电源。用跳线接头连接两个针脚，保持 5 秒钟，然后取下跳线接头。

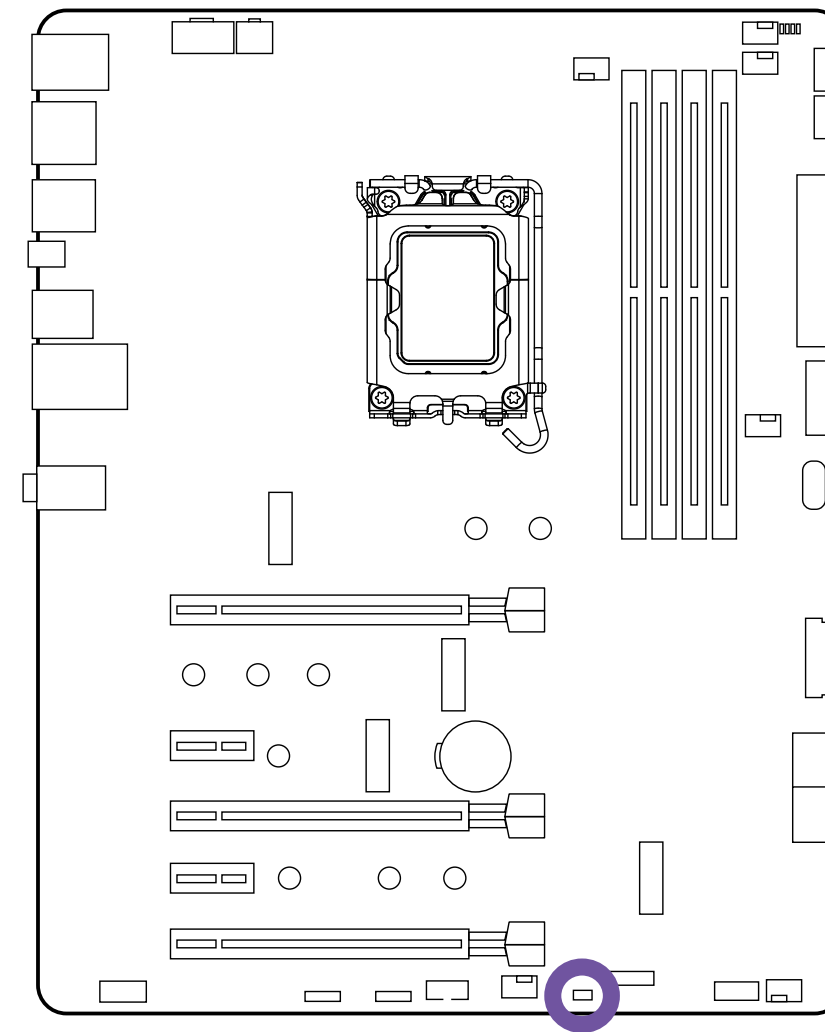

Clear CMOS Jumper

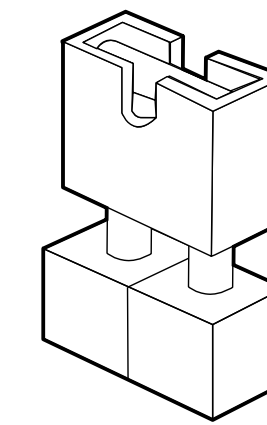

SHORT

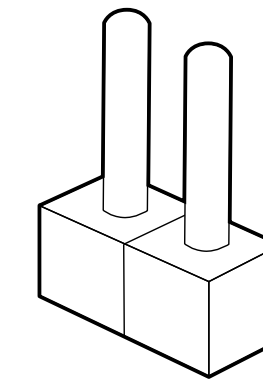

OPEN



开机自检 LED

开机自检 LED 指示灯会在用户打开系统电源后对计算机进行诊断。指示灯会点亮以指示 CPU、内存、VGA 或存储设备是否存在故障。如果上述四个功能正常，指示灯会熄灭。

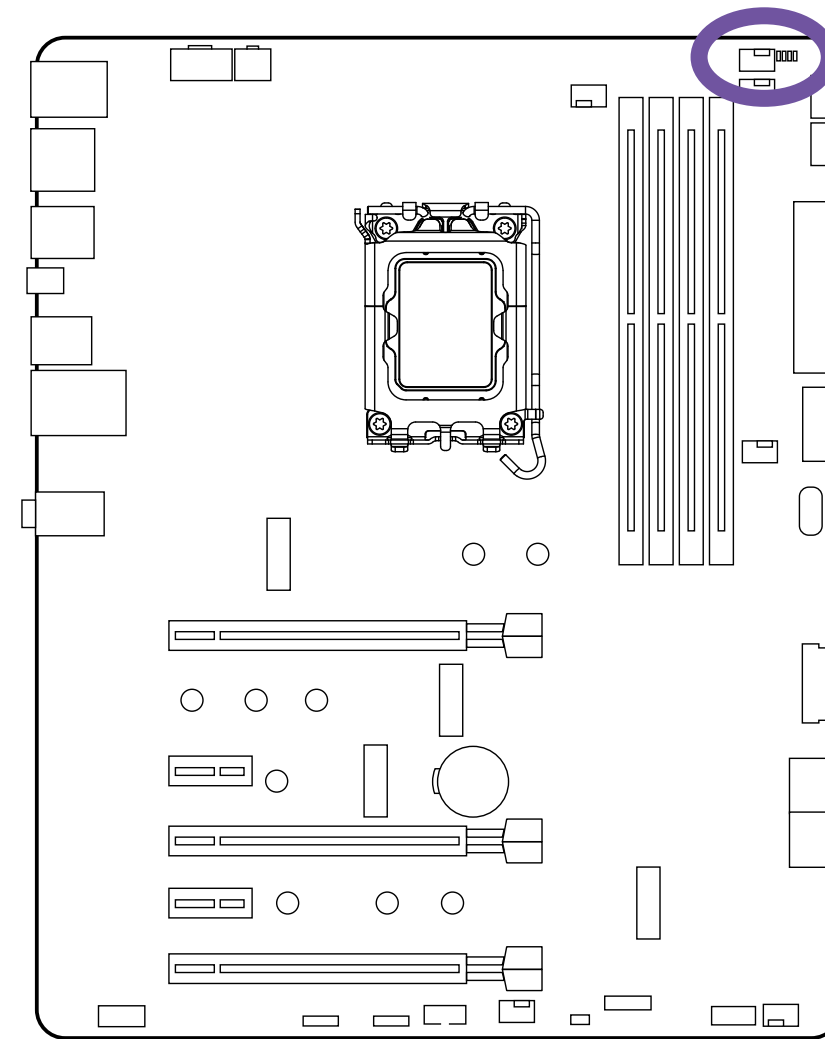

3.21 CMOS 电池



如果 BIOS 设置无法保存，可能是主板 CMOS 电池 (CR2032) 电量用尽。您可以卸下金属盖板，更换电池。

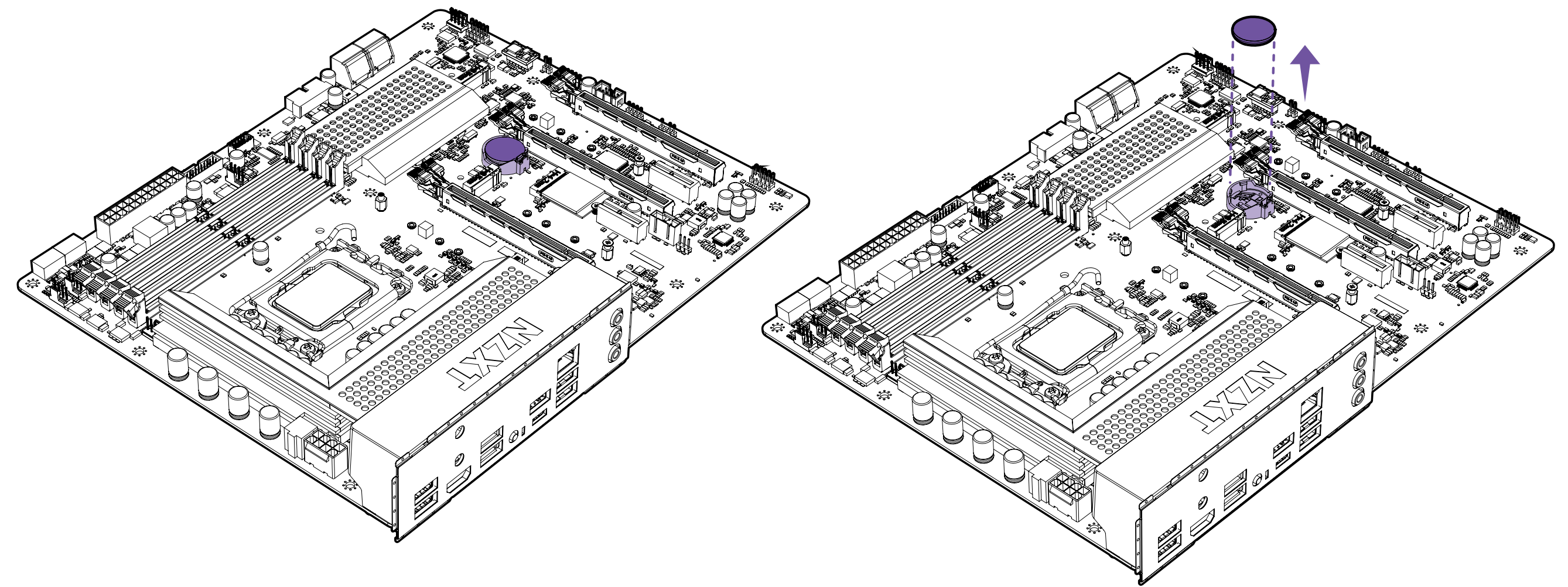



您可以使用 U 盘和最新 BIOS 文件，在没有 CPU 的情况下更新 BIOS，并且不需要打开系统电源。要使用 BIOS Flashback 功能，请执行以下操作。

注意

- 准备 U 盘需要使用单独的 PC 系统。
- 如果 LED 绿色常亮，表示 BIOS Flashback 未正常工作。请将 U 盘插入 USB BIOS Flashback 端口。
- 使用 BIOS Flashback 功能之前，请暂停 BitLocker 和 TPM 的所有加密或安全功能。更新 BIOS 之前，建议禁用 fTPM。否则可能会发生不可预知的故障。

- 从 NZXT 网站 <http://www.nzxt.com> 下载最新 BIOS 文件。
- 将 BIOS 文件解压到安全位置，然后将其重命名为“creative.rom”。
- 准备一个 U 盘，将其以 FAT32 格式进行格式化，然后将“creative.rom”复制到闪存盘的根目录。
- 将 24 针电源接头插到主板上，并打开电源的交流开关。请勿打开系统电源。
- 将 U 盘插入主板后置 I/O 面板上标有“BIOS”的 USB 接口。
- 按下 BIOS Flashback 按钮约 3 秒，开始刷新。按钮将会闪烁，表示刷新已开始。
- 等待 LED 停止闪烁并熄灭，表示 BIOS 刷新已完成。

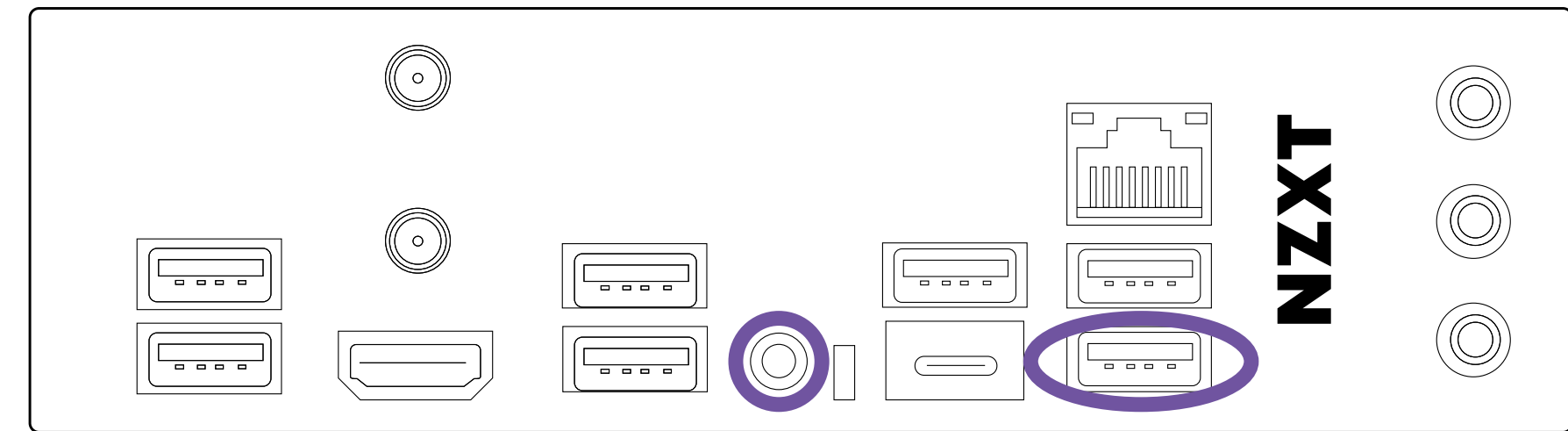



NZXT CAM

Download and install NZXT CAM from nzxt.com/camapp.

Descargue e instale NZXT CAM en nzxt.com/camapp.

Téléchargez et installez NZXT CAM depuis nzxt.com/camapp.

laden Sie NZXT CAM von nzxt.com/camapp herunter und installieren Sie die Software.

Scaricare e installare NZXT CAM da nzxt.com/camapp.

Baixe e instale o NZXT CAM de nzxt.com/camapp.

загрузите и установите приложение NZXT CAM со страницы nzxt.com/camapp.

nzxt.com/camapp 에서 NZXT CAM을 다운로드하여 설치하십시오.

NZXT CAMは nzxt.com/camapp からダウンロード・インストール可能です。

請从：nzxt.com/camapp 下载并安装 NZXT CAM 软件。

請從 nzxt.com/camapp 下載並安裝 NZXT CAM。

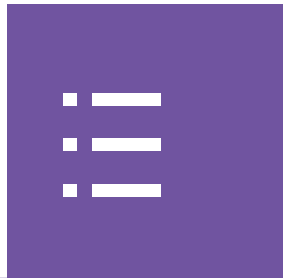

5.1 NZXT Global Warranty Policy..... A-2

5.2 Support and Service..... A-8

5.3 Regulatory Notices.....A-11

5.4 限用物质及元素列表/限用物質及元素清單 A-13

5.5 Battery Information..... A-14

5.6 WEEE Statement A-15

5.7 Revision History..... A-19

5.1 NZXT GLOBAL WARRANTY POLICY

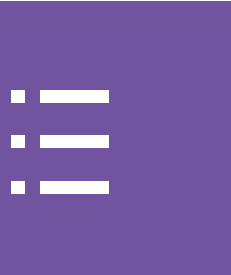

This NZXT Global Warranty Policy governs the sale of products by NZXT to you.

I. WARRANTY LENGTH

Any replacement product will be covered under warranty for the remainder of the warranty period or thirty days, whichever is longer. Proof of purchase is required for warranty service.

II. WHO IS PROTECTED

The Warranty covers only NZXT products purchased by the original consumer.

NEW NZXT PRODUCT	WARRANTY LENGTH FOR PARTS
Computer Cases	2 Years
Temperature Meters	2 Years
Fans	2 Years
Lighting	2 Years
Accessories	2 Years
Kraken M Coolers	3 Years
Headset/Headphone	2 Years
Headset/Headphone Storage	2 Years
Mixer	2 Years
Motherboards	3 Years
Gold Power Supply	10 Years
Bronze Power Supply	5 Years
Kraken X/Z Coolers	6 Years
Mini ITX Case with PSU, AIO, and Riser Card	3-year warranty on case, riser card, and AIO. 10-year warranty on PSU.
REFURBISHED NZXT PRODUCT	WARRANTY LENGTH FOR PARTS
All NZXT Certified Refurbished Products	1 Years



III. WHAT IS AND IS NOT COVERED

Please note that our warranty is not an unconditional guarantee. If the product, in NZXT's reasonable opinion, malfunctions within the warranty period, NZXT will provide you at its sole discretion with a repaired or replacement product, either new or refurbished, with a similar function that is equal or greater in value depending on supply.

Our warranty does not cover the following:

- any product or serial number/warranty sticker modification applied without permission from NZXT;
- any damage that is not a manufacturing defect;
- damage, deterioration or malfunction resulting from: accident, abuse, misuse, neglect, fire, water, lightning, or other acts of nature, unauthorized product modification or failure to follow instructions included with the product;
- improper installation, unauthorized alterations or modifications, or repair or attempted repair by anyone not authorized by NZXT;
- shipping or transport damage (claims must be made with the carrier);
- normal wear and tear.

NZXT does not warrant that this product will meet your requirements. It is your responsibility to determine the suitability of this product for your purpose. For NZXT Store orders, we cover two way return shipping for all exchanges and returns. For all other authorized dealers, NZXT Support does not cover return shipping and only covers one way shipping from NZXT back to the end user for exchanges. Two way expedited shipping is provided for all PSUs covered under the Less Than Three program, indiscriminate of purchase location, provided the location is an approved NZXT reseller.

IV. EXCLUSION OF DAMAGES (DISCLAIMER)

NZXT's sole obligation and liability under this warranty is limited to the repair or replacement of a defective product with either a new or refurbished product with a similar function that is equal or greater in value at our option. NZXT shall not, in any event, be liable for any incidental or consequential damage, including but not limited to damages resulting from interruption of service and loss of data, business, or for liability in tort relating to this product or resulting from its use or possession.



V. LIMITATIONS OF IMPLIED WARRANTIES

Here are no other warranties, expressed or implied, including but not limited to those of merchantability or fitness for a particular purpose. The duration of implied warranties is limited to the warranty length specified in Paragraph I.

VI. TO OBTAIN TECHNICAL SUPPORT

If you have already referenced your product owner's manual and still need help, you may contact us by phone at +1 (800) 228-9395, by email at service@nzxt.com, or visit the NZXT Support site at nzxt.com/customer-support.

VII. HOW TO OBTAIN A WARRANTY SERVICE FROM NZXT

To receive a warranty service for your product when purchased directly from NZXT, you must submit a request via the NZXT Support site outlining the problem. If a technician deems the product defective or requiring testing, you will be required to provide a copy of your proof of purchase, which will enable you to submit a Return Merchandise Authorization "RMA" request.

Once approved, you`ll receive an RMA number, upon which you will be asked to ship the defective item back to NZXT with the RMA number clearly marked or labelled on the package. NZXT recommends that appropriate measures are taken to safeguard the product from damage during shipping.



VIII. APPLICABLE LAW AND ADDITIONAL LEGAL RIGHTS FOR CONSUMERS

This warranty gives you specific legal rights. These conditions are governed and construed in accordance with the laws of California (with exception of its conflict of law provisions), and the application of the United Nations Convention of Contracts for the International Sale of Goods is expressly excluded. The non-exclusive jurisdiction of the courts of California is agreed, which means that you may bring a claim to enforce your consumer protection rights in connection with this Global Warranty in the country which you have your habitual residence where you may have additional rights. These rights may vary.

For original consumers who are covered by consumer protection laws or regulations in their country, state, or province of purchase or, if different, their country, state, or province of residence, the benefits conferred by this warranty are in addition to all rights and remedies conveyed by such consumer protection laws and regulations. To the extent that liability under such consumer laws can be limited, NZXT's liability is limited, and its sole option, to repair or replacement, either new or refurbished, with a similar function that is equal or greater in value depending on supply.

In the United Kingdom:

- For NZXT products sold to customers in the UK, during the expected lifespan of your product your legal rights entitle you to the following:
 - > Up to 30 days: if your goods are faulty, then you can get an immediate refund.
 - > Up to six months: if your goods can't be repaired or replaced, then you're entitled to a full refund, in most cases.
 - > Up to six years: if your goods do not last a reasonable length of time you may be entitled to some money back.
- If the person seeking to rely on the guarantee is not the original consumer, the NZXT Warranty will cover the product in relation to that person provided that they are able to provide proof of the transfer of the benefit of the guarantee from the original consumer.
- The implied warranties under the Consumer Rights Act 2015 says that your goods must be as described, fit for all purposes for which such goods are usually supplied, and of satisfactory quality.

In the EU:

- If you are a consumer and have your habitual residence in the EU, you additionally enjoy the protection afforded to you by provisions that cannot be derogated from by agreement by virtue of the law where you have your habitual residence.



IX. WARRANTY SERVICE FROM RESELLERS

In the event that a warranty service is sought, you must provide proof of purchase (store receipt or invoice) in order to receive the service and if deemed necessary, repair or replacement product.

In North America:

Within the first 60 days after purchase, please return your product (or for power supplies installed within our enclosures, just the failed power supply) to your dealer or reseller for a replacement. If the product is still within warranty and you can no longer return it to your dealer, please contact NZXT Customer Support (see above) for assistance and instructions. NZXT will not accept returns without prior approval and an RMA number.

In Europe:

Within the first year after purchase, please return your product (or for power supplies installed within our enclosures, just the failed power supply) to your dealer or reseller for a replacement. If the product is still within warranty and you can no longer return it to your dealer, please contact NZXT Customer Support (see above) for assistance and instructions. NZXT will not accept returns without prior approval.

In Australasia:

Within the first two years after purchase, please return your product (or for power supplies installed within our enclosures, just the failed power supply) to your dealer or reseller for a replacement. If the product is still within warranty and you can no longer return it to your dealer, please contact NZXT Customer Support (see above) for assistance and instructions. NZXT will not accept returns without prior approval.

The cost of shipping will be borne at the first instance by you; however, if the purchased item is defective, NZXT will reimburse reasonable postage or transportation of costs.

Outside North America, Europe, and Australasia:

If your product needs to be returned within the warranty period, please contact the retailer or distributor from whom you purchased the product.



X. NZXT.COM STORE RETURNS/EXCHANGE POLICY

Eligible products under this NZXT Warranty qualify for a full refund or exchange only with an authorized RMA number and if the item is returned to the NZXT.com store inventory within 30 days of purchase. Returns are not allowed beyond 30 days of the purchase date. The NZXT.com Store reserves the right to deny any return or exchange. Refunds will be credited to the original method of payment. To initiate a return, simply submit a request via NZXT support site.

- > Visit nzxt.com/warranty and support.nzxt.com for information on warranty coverage and service.
- > Visite el sitio Web nzxt.com/warranty y support.nzxt.com para obtener información sobre la cobertura y el servicio de la garantía.
- > Visitez nzxt.com/warranty et support.nzxt.com pour les informations de la couverture de la garantie et du service.
- > Informationen zu Geltungsbereich und Service der Garantie finden Sie unter support.nzxt.com und nzxt.com/warranty.
- > Visitare il sito nzxt.com/warranty e support.nzxt.com per informazioni sulla copertura e sul servizio della garanzia.
- > Visite nzxt.com/warranty e support.nzxt.com para obter informações sobre a cobertura da garantia e assistência.
- > Подробную информацию об условиях гарантийного обслуживания см. на веб-сайте nzxt.com/warranty и support.nzxt.com.
- > 제품 보증 범위와 서비스 정보를 확인하시려면 nzxt.com/warranty 또는 support.nzxt.com 을 방문해 주시기 바랍니다.
- > 保証範囲およびサービスに関する情報については、support.nzxt.com と nzxt.com/warranty にアクセスしてください。
- > 请造访 nzxt.com/warranty 和 support.nzxt.com 了解保修范围和服务的信息。
- > 請訪問 nzxt.com/warranty 和 support.nzxt.com 了解產品保固範圍和更多服務訊息。

NZXT, Inc./ 15736 E Valley Blvd, City of Industry, CA 91744, USA
NZXT Europe GmbH/ Industriering Ost 66 | 47906 Kempen | Germany
+1 (800) 228-9395 / service@nzxt.com / [NZXT.com](https://nzxt.com)



SUPPORT AND SERVICE

If you have any questions or problems with the NZXT product you purchased, please don't hesitate to contact us using our support system. support.nzxt.com

Please include a detailed explanation of your problem and your proof of purchase. For comments and suggestions, you can e-mail our design team, designer@nzxt.com. Lastly we would like to thank you for your support by purchasing this product.

For more information about NZXT, please visit us online. NZXT Website: [NZXT.com](https://nzxt.com)

SOPORTE Y SERVICIO

Si tiene preguntas o problemas con el producto NZXT que usted compró, no dude en ponerse en contacto con service@nzxt.com y suministrar una explicación detallada de su problema así como su prueba de compra. Puede hacer consultas sobre piezas de repuesto en support.nzxt.com. Para comentarios y sugerencias, escriba un mensaje de correo electrónico a nuestro equipo de diseño: designer@nzxt.com. Gracias por comprar un producto NZXT. Para más información acerca de NZXT, visítenos en línea. Página web de NZXT: [NZXT.com](https://nzxt.com)

SUPPORT ET SERVICE

Si vous avez des questions ou des problèmes avec le produit NZXT que vous avez acheté, n'hésitez pas à contacter service@nzxt.com avec une description détaillée de votre problème et votre preuve d'achat. Vous pouvez aussi commander des pièces de remplacement auprès support.nzxt.com. Pour les commentaires et les suggestions, envoyez un email à notre équipe de design, designer@nzxt.com. Merci d'avoir acheté ce produit de NZXT. Pour plus d'informations sur NZXT, visitez notre site Web. Site Web de NZXT : [NZXT.com](https://nzxt.com)

KUNDENDIENST UND SERVICE

Falls Fragen oder Probleme bezüglich Ihres NZXT-Produktes auftreten, wenden Sie sich bitte mit einer detaillierten Problembeschreibung und Ihrem Kaufbeleg an service@nzxt.com. Ersatzteile können Sie unter support.nzxt.com anfragen. Kommentare und Anregungen senden Sie bitte per designer@nzxt.com an unser Designteam. Vielen Dank, dass Sie ein NZXT-Produkt erworben haben. Weitere Informationen über NZXT erhalten Sie im Internet. NZXT-Webseite: [NZXT.com](https://nzxt.com)



ASSISTENZA E SERVIZIO

In caso di dubbi o problemi con il prodotto NZXT acquistato, non esitate a contattarci utilizzando il nostro sistema di assistenza.

support.nzxt.com

Includere una spiegazione dettagliata del problema e la prova di acquisto. Per commenti e suggerimenti, siete pregati di inviare un messaggio al nostro team di progettisti, all'indirizzo: designer@nzxt.com. Infine, vogliamo ringraziarvi del vostro supporto con l'acquisto di questo prodotto. Per altre informazioni su NZXT, visitate il nostro sito. Sito NZXT: [NZXT.com](https://nzxt.com)

ASSISTÊNCIA E MANUTENÇÃO

Caso tenha questões ou problemas com o produto NZXT adquirido, não hesite em contactar-nos através do endereço service@nzxt.com fornecendo a explicação detalhada do seu problema e a prova de compra. Poderá solicitar peças de substituição através do endereço support.nzxt.com. Para comentários e sugestões, contacte a nossa equipa de design através do endereço de e-mail, designer@nzxt.com. Obrigado por ter adquirido um produto NZXT. Para mais informações acerca da NZXT, visite-nos online. Web site da NZXT: [NZXT.com](https://nzxt.com)

СЛУЖБА ПОДДЕРЖКИ И ОБСЛУЖИВАНИЯ

В случае возникновения вопросов или неисправностей в приобретенных вами продуктах NZXT обращайтесь по адресу: service@nzxt.com с подробным описанием проблемы и подтверждением покупки. О наличии запчастей можно узнать, обратившись по адресу: support.nzxt.com. Замечания и предложения отправляйте в адрес нашей группы разработчиков: designer@nzxt.com. Благодарим вас за покупку продукта NZXT. Более подробная информация о компании NZXT представлена на наших веб-сайтах. Веб-сайт NZXT: [NZXT.com](https://nzxt.com)



지원 및 서비스

구입한 NZXT 제품과 관련하여 질문 또는 문제가 있을 경우, 당사의 지원 시스템 (support.nzxt.com)을 사용하여 문의하십시오.

문제를 자세히 기술하고 구매 증빙을 제출하십시오. 의견 또는 제안 사항이 있을 경우 당사 설계 팀에 designer@nzxt.com으로 이메일을 보내십시오. 마지막으로 이 제품을 구입하여 당사를 응원해 주셔서 감사합니다. NZXT에 대해 자세히 알려면 온라인으로 방문하십시오. NZXT 웹사이트: [NZXT.com](https://nzxt.com)

サポートおよびサービス

購入されましたNZXTの製品に関するご質問または問題は、問題の詳細および購入の証明を添えて、ご遠慮なくservice@nzxt.comまでご連絡ください。交換部品はsupport.nzxt.comまでお尋ねください。ご意見およびご提案は弊社設計チーム、designer@nzxt.comまでメールを送信してください。NZXT製品をご購入いただきましてありがとうございます。NZXTに関する詳細は、インターネット上のウェブサイトをご覧ください。NZXT ウェブサイト: [NZXT.com](https://nzxt.com)

支持和服務

如果有任何疑问或者在使用 NZXT 产品的过程中遇到任何问题,欢迎联络 service@nzxt.com,联络时请提供关于问题的详细说明及购买凭证。您可以向 support.nzxt.com 查询更换部件。如有任何意见或建议,欢迎致信我们的设计团队,电子邮件地址是 designer@nzxt.com。感谢您购买 NZXT 产品。有关 NZXT 的更多信息,请造访我们的在线网站。NZXT 网站: [NZXT.com](https://nzxt.com)

支援和服務

如果在使用NZXT 產品的過程中有遇到任何問題或疑問，歡迎聯繫 service@nzxt.com，並請提供問題的詳細敘述及購買證明。您可以透過 support.nzxt.com 查詢更換部件。如有任何意見或建議，歡迎來信與設計團隊聯繫 designer@nzxt.com。最後，感謝您購買 NZXT 產品。有關 NZXT 的更多信息，請訪問我們的網站。NZXT 網站: [NZXT.com](https://nzxt.com)

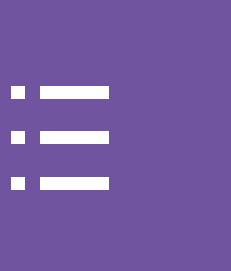

FCC COMPLIANCE STATEMENT

This equipment has been tested and found to comply with the limits for a Class B digital device, pursuant to Part 15 of the FCC Rules. These limits are designed to provide reasonable protection against harmful interference in a residential installation. This equipment generates, uses, and can radiate radio frequency energy and, if not installed and used in accordance with the instructions, may cause harmful interference to radio communications. However, there is no guarantee that interference will not occur in a particular installation. If this equipment does cause harmful interference to radio or television reception, which can be determined by turning the equipment off and on, the user is encouraged to try to correct the interference by one or more of the following measures:

- Reorient or relocate the receiving antenna
- Increase the separation between the equipment and the receiver
- Connect the equipment onto an outlet on a circuit different from that to which the receiver is connected
- Consult the dealer or an experienced radio/TV technician for help

Shielded interconnect cables and a shielded AC power cable must be employed with this equipment to ensure compliance with the pertinent RF emission limits governing this device. Changes or modifications not expressly approved by the system's manufacturer could void the user's authority to operate the equipment.



DECLARATION OF CONFORMITY

I. THIS DEVICE COMPLIES WITH PART 15 OF THE FCC RULES. OPERATION IS SUBJECT TO THE FOLLOWING CONDITIONS:

- This device may not cause harmful interference
- This device must accept any interference received, including interference that may cause undesired operation.

II. THIS DEVICE IS IN CONFORMITY WITH THE FOLLOWING EC/ EMC DIRECTIVES:

EN 55022	Limits and methods of measurement of radio disturbance characteristics of information technology equipment
EN 61000-3-2	Disturbance in supply systems caused
EN 61000-3-3	Disturbance in supply systems caused by household appliances and similar electrical equipment "Voltage fluctuations"
EN 55024	Information technology equipment-immunity characteristics - Limits and methods of measurement
EN 60950	Safety for information technology equipment including electrical business Equipment

III. CE CONFORMITY

NZXT Inc, declares that this device is in compliance with the essential safety requirements and other relevant provisions set out in the European Directive.

IV. CANADIAN DEPARTMENT OF COMMUNICATIONS

This class B digital apparatus meets all requirements of the Canadian Interference-causing Equipment Regulations.
Cet appareil numérique de la classe B respecte toutes les exigences du Règlement sur le matériel brouilleur du Canada.

V. KOREAN CERTIFICATION MARK

Includes a KCC (Korean Communications Commission) certification number: KCC-R-R-ZXT-N5Z69XT.

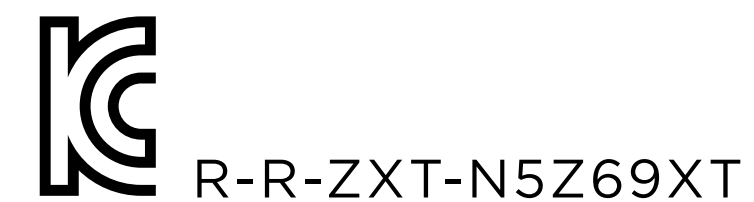

5.4 有害物质含量说明標示/限用物質含量標示聲明

N5 Z690 INTEL ATX MOTHERBOARD

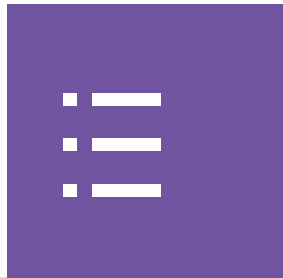

ROHS COMPLIANCE

产品名称：N5 Z690主板 (型号：N5-Z69XT-W1/B1)

有害物质

部件名称	铅(Pb)	镉(Cd)	汞(Hg)	六价铬(Cr ⁶⁺)	多溴联苯(PBB)	多溴联苯醚(PBDE)
钮扣电池	×	○	○	○	○	○
电路板	×	○	○	○	○	○
电子组件	×	○	○	○	○	○
线材	○	○	○	○	○	○
配件	○	○	○	○	○	○

本表格依据SJ/T 11364的规定编制。

○: 表示该有害物质在该部件所有均质材料中的含量均在 GB/T 26572 规定的限量 要求以下。

×: 表示该有害物质至少在该部件的某一均质材料中的含量超出 GB/T 26572 规定的 限量要求,然该部件仍符合欧盟命令 2011/65/EU 的规范。

备注:此产品所标示的环保使用期限,系指在一般正常使用状况下。

產品名稱：N5 Z690主機板 (型號：N5-Z69XT-W1/B1)

限用物質及其化學符號

單元	鉛(Pb)	鎘(Cd)	汞(Hg)	六價鉻(Cr ⁶⁺)	多溴聯苯(PBB)	多溴聯苯醚(PBDE)
電路板	○	○	○	○	○	○
電子元件	—	○	○	○	○	○
線材	—	○	○	○	○	○
配件	—	○	○	○	○	○

備考1. “超出0.1wt%”及“超出0.01wt%”係指限用物質之百分比含量超出百分比含量基準值。

備考2. “○” 係指該項限用物質之百分比含量未超出百分比含量基準值。

備考3. “—” 係指該項限用物質為排除項目。

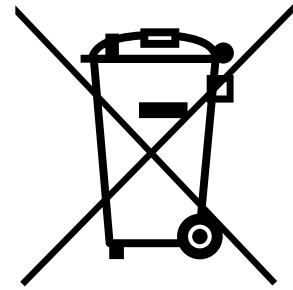
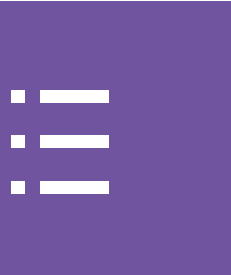

EUROPEAN UNION

Batteries, battery packs, and accumulators should not be disposed of as unsorted household waste. Please use the public collection system to return, recycle, or treat them in compliance with the local regulations.

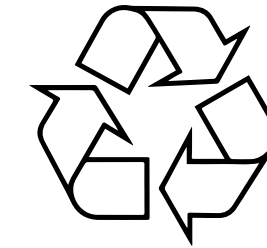

CALIFORNIA, USA

The button cell battery may contain perchlorate material and requires special handling when recycled or disposed of in California. For further information please visit: <http://www.dtsc.ca.gov/hazardouswaste/perchlorate>

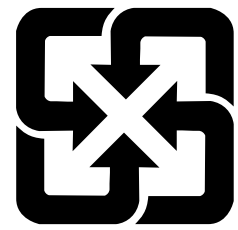

TAIWAN

For better environmental protection, waste batteries should be collected separately for recycling or special disposal.

CAUTION

* There is a risk of explosion, if battery is incorrectly replaced. Replace with the same or equivalent type recommended by the manufacturer.



ENGLISH

To protect the global environment and as an environmentalist, NZXT must remind you that...

Under the European ("EU") Directive on Waste Electrical and Electronic Equipment, Directive 2012/19/EU, effective February 14, 2014, products of "electrical and electronic equipment" cannot be discarded as municipal wastes, and manufacturers of covered electronics must take back such products at the end of their useful life. NZXT will comply with the product take back requirements at the end-of-life of NZXT products that are sold within the EU. You can return these products to local collection points.

ESPAÑOL

NZXT como empresa comprometida con la protección del medio ambiente, recomienda:

Bajo la directiva 2012/19/EU de la Unión Europea en materia de desechos y/o equipos electrónicos, con fecha de rigor desde el 14 de febrero de 2014, los productos clasificados como "eléctricos y equipos electrónicos" no pueden ser depositados en los contenedores habituales de su municipio, los fabricantes de equipos electrónicos, están obligados a hacerse cargo de dichos productos al término de su período de vida. NZXT estará comprometido con los términos de recogida de sus productos vendidos en la Unión Europea al final de su periodo de vida. Usted debe depositar estos productos en el punto limpio establecido por el ayuntamiento de su localidad o entregar a una empresa autorizada para la recogida de estos residuos.



FRANÇAIS

En tant qu'écologiste et afin de protéger l'environnement, NZXT tient à rappeler ceci...

Au sujet de la directive européenne (EU) relative aux déchets des équipement électriques et électroniques, directive 2012/19/EU, prenant effet le 14 février 2014, que les produits électriques et électroniques ne peuvent être déposés dans les décharges ou tout simplement mis à la poubelle. Les fabricants de ces équipements seront obligés de récupérer certains produits en fin de vie. NZXT prendra en compte cette exigence relative au retour des produits en fin de vie au sein de la communauté européenne. Par conséquent vous pouvez retourner localement ces matériels dans les points de collecte.

DEUTSCH

Hinweis von NZXT zur Erhaltung und Schutz unserer Umwelt
Gemäß der Richtlinie 2012/19/EU über Elektro- und Elektronik-Altgeräte dürfen Elektro- und Elektronik-Altgeräte nicht mehr als kommunale Abfälle entsorgt werden. NZXT hat europaweit verschiedene Sammel- und Recyclingunternehmen beauftragt, die in die Europäische Union in Verkehr gebrachten Produkte, am Ende seines Lebenszyklus zurückzunehmen. Bitte entsorgen Sie dieses Produkt zum gegebenen Zeitpunkt ausschliesslich an einer lokalen Altgerätesammelstelle in Ihrer Nähe.

ITALIANO

Per salvaguardare l'ambiente globale, NZXT ricorda che:
La Direttiva Europea (UE) RAEE, in materia di rifiuti costituiti da apparecchiature elettriche ed elettroniche (Direttiva 2012/19/UE, in vigore dal 14 febbraio 2014), le apparecchiature elettriche ed elettroniche non possono essere smaltite tra i rifiuti municipali e i produttori di apparecchiature elettroniche sono tenuti a ritirare tali prodotti alla fine del ciclo di vita utile. NZXT è conforme ai requisiti inerenti al ritiro a fine vita dei prodotti NZXT venduti nell'UE. Questi prodotti devono essere conferiti nei centri di raccolta locali.



PORTUGUÊS

Para proteger o meio ambiente global e como um ambientalista, a NZXT lembra você de que...

Sob a Diretiva Europeia (“EU”) sobre Equipamentos Eletroeletrônicos Residuais, Diretiva 2012/19/EU, em vigor desde 14 de fevereiro de 2014, produtos de “equipamentos eletroeletrônicos” não podem ser descartados como lixo municipal e os fabricantes de eletrônicos cobertos devem receber de volta tais produtos no fim de sua vida útil. A NZXT cumprirá os requisitos de recolhimento do produto ao fim da vida útil dos produtos da NZXT vendidos dentro da UE. Você pode devolver esses produtos aos pontos de coleta locais.

РУССКИЙ

В целях поддержки движения защитников окружающей среды и охраны глобальной окружающей среды компания NZXT напоминает вам...

В соответствии с требованиями Директивы по утилизации электрического и электронного оборудования ЕС 2012/19/EU от 14 февраля 2014 г. продукты, являющиеся «электрическим и электронным оборудованием», должны утилизироваться отдельно от бытовых отходов, и производители оборудования, подпадающего под действие данной директивы, должны принимать такие продукты в случае их возврата в конце срока службы. NZXT будет соблюдать требования к возврату продукта производителю в конце срока службы продуктов NZXT, которые продаются на территории ЕС. Для возврата продуктов производителю созданы специализированные пункты приема.



한국어

지구를 보호하고, 환경에 친화적인 기업인 NZXT는 다음 사항을 안내합니다. 2014년 2월 14일부터 시행되는 Directive 2012/19/EU, 폐전기·전자제품에 관한 유럽연합(“EU”)의 지침에 따라 “전기·전자제품”은 일반폐기물로서 폐기할 수 없으며, 수명이 다한 제품은 반드시 해당 제품의 제조업체가 회수해야 합니다. NZXT는 유럽 내에서 판매되는 NZXT 제품에 대한 회수 지침을 준수합니다. 수명이 다한 제품은 해당 지역의 회수처에 반납하실 수 있습니다.

日本語

NZXTはかけがえのない地球環境を保護するために、廃電気・電子製品(WEEE)に関する欧州連合(EU)の指令を遵守します。WEEE指令2012/19/EU(2014年2月14日発効)で定められた通り、EU域内では電気機器・電子機器製品は地方自治体の廃棄物として廃棄できないため、対象となる電子機器メーカーは、製品が耐用年数に達した際に該当製品を引き取る必要があります。NZXTは、EU内で販売されるNZXT製品の耐用年数終了時の製品引き取り要件を遵守します。ユーザーの方におかれましては、該当製品を最寄りの回収場所にお出しいただけますよう、お願いいたします。

简体中文

作为一家环保型企业，为保护全球环境，NZXT 提醒您..... 根据 2014 年 2 月 14 日生效的欧洲 (“EU”) 废弃电子电气设备指令——第 2012/19/EU 号指令的规定，“电气和电子设备”产品不可作为市政废物丢弃，相关电子产品的制造商须在此类产品使用寿命结束时将其收回。对于 NZXT 在欧盟地区售出的 NZXT 产品报废时，NZXT 将遵循该产品回收要求。您可以将这些产品送至当地的回收点。

中文

為保護全球環境，NZXT 提醒您... 依據 2014 年 2 月 14 日生效的歐盟 (「EU」) 廢棄電子電氣設備指令第 2012/19 / EU 號指令規定，「電氣和電子設備」產品不得視為都市廢棄物丟棄，相關的電子產品製造商必須在產品使用壽命結束時將產品回收。對於歐盟境內銷售的 NZXT 產品，NZXT 將在產品使用壽命結束時，按照產品回收要求收回產品。您可以將這些產品送到當地的回收點。

5.7 REVISION HISTORY



Version 1.3, 2022/05/11