

# Fisher 5S™

## Technical Information Pack



\* Fisher 5S™ model shown



FSTP050422INT

# Fisher 5SE™

 **JETS** 22

 **SEATING** 5 seats

 **DIMENSIONS** 2.00 x 2.00 x 0.84m

## SPECIFICATIONS

Dry weight .....	286 kg
Water capacity.....	1097 litres
Filled weight .....	1398 kg
SmartFlo™ jet pump(s).....	1 x 2.5 hp
SmartFlo™ circulation pump .....	1
Electrical requirements .....	10 amp*

\* Check with electrician about dedicated circuit requirements

## FEATURES

- QuadCore™ shell construction
- FisherFlex™ plumbing system
- Reflect™ perimeter insulation
- SoftTouch™ head rest
- Toughbase™ insulated, moulded ABS
- FisherFrame™ high-impact plastic frame
- Stainless steel jets
- FisherGlow™ in-spa illumination
- SpaNet SV Mini™ control system
- Dynamic Thermal Tuning™
- Integrated heat pump control

## OPTIONAL UPGRADES

- SpaNet™ heat pump
- Fisher™ WiFi & audio system

## WARRANTIES

Non Pro rata Structural.....	10yrs
Non Pro rata Acrylic Surface.....	5yrs
Plumbing, Heater & Jets .....	5yrs
Pumps & Equipment .....	2yrs
Frame .....	Lifetime



\*\* Conditions apply. Specifications may change without notice.  
May be pictured with some options included.



# Fisher 5S™



JETS

34



SEATING

5 seats



DIMENSIONS 2.00 x 2.00 x 0.84m

## SPECIFICATIONS

Dry weight .....	296 kg
Water capacity.....	1097 litres
Filled weight .....	1408 kg
SmartFlo™ jet pump(s).....	1 x 2.5 hp
SmartFlo™ circulation pump .....	1
SmartFlo™ air blower .....	1
Electrical requirements .....	15 amp

## FEATURES

- QuadCore™ shell construction
- FisherFlex™ plumbing system
- Reflect™ perimeter insulation
- SoftTouch™ head rest
- Toughbase™ insulated, moulded ABS
- FisherFrame™ high-impact plastic frame
- Stainless steel jets
- FisherGlow™ in-spa illumination
- FisherGlow™ LED perimeter lighting
- SpaNet SV Mini™ control system
- Dynamic Thermal Tuning™
- Integrated heat pump control

## OPTIONAL UPGRADES

- SpaNet™ heat pump
- Fisher™ WiFi & audio system

## WARRANTIES

Non Pro rata Structural.....	10yrs
Non Pro rata Acrylic Surface.....	5yrs
Plumbing, Heater & Jets .....	5yrs
Pumps & Equipment .....	2yrs
Frame .....	Lifetime



\* Conditions apply. Specifications may change without notice.  
May be pictured with some options included.

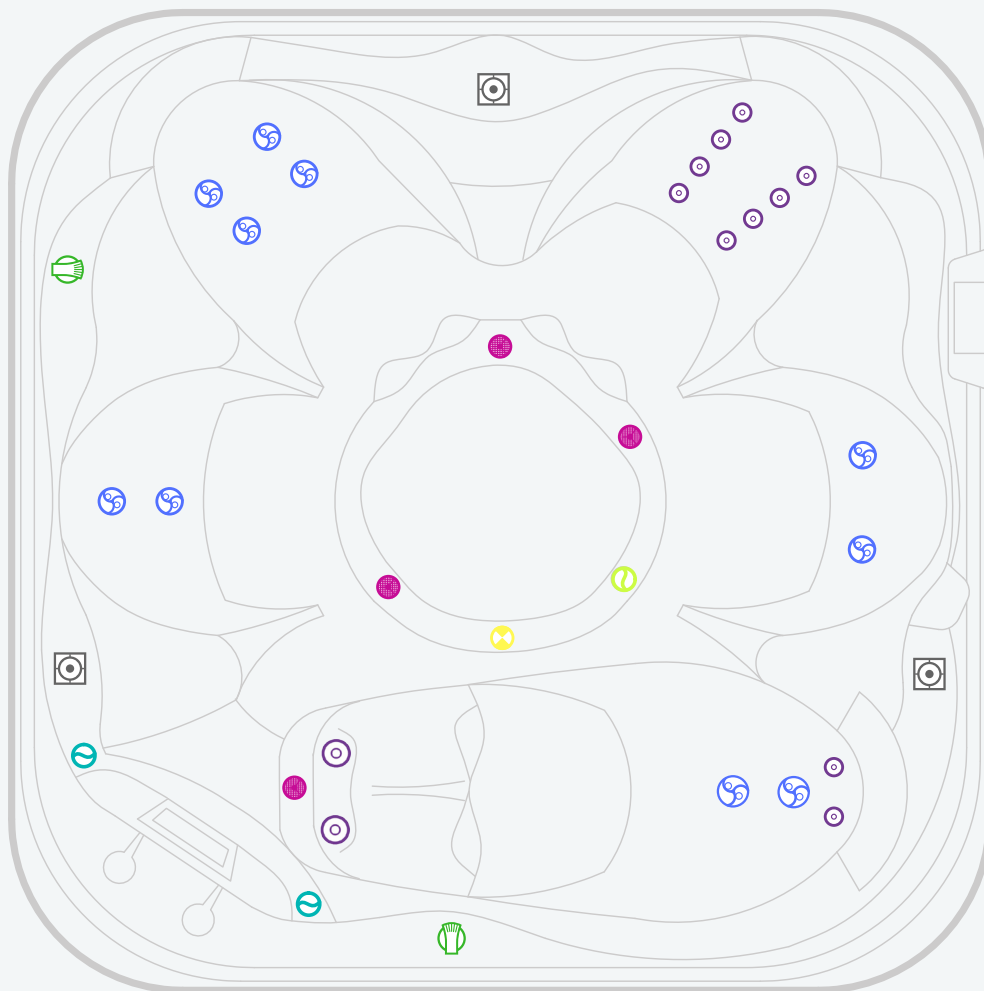





Illustration shows Fisher 5SE™ spa pool model

 2 x Air Controls

 1 x Drain

 10 x 50mm Directional Jets

 2 x 88mm Directional Jets

 2 x 127mm Roto Jets

 1 x Light

 8 x 88mm Roto Jets

 4 x Suction

 3 x Speakers

 4 x Vents

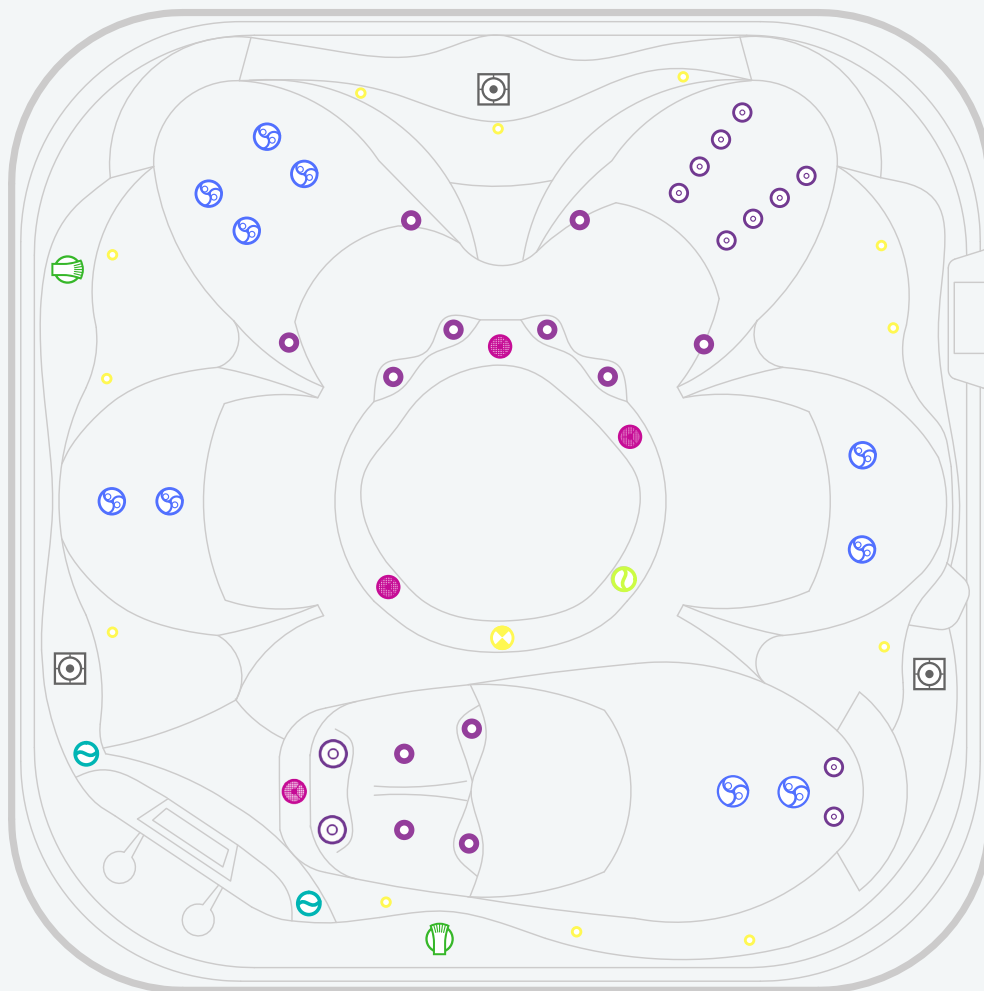



Illustration shows Fisher 5S™ spa pool model

 2 x Air Controls

 1 x Drain

 10 x 50mm Directional Jets

 2 x 88mm Directional Jets

 12 x Perimeter Lights

 1 x Lights

 12 x Air Jets

 4 x Suction

 8 x 88mm Twin Hole Jets

 2 x 127mm Roto Jets

 3 x Speakers

 4 x Vents

# Fisher 5S™ & Fisher 5SE™

## Equipment Location

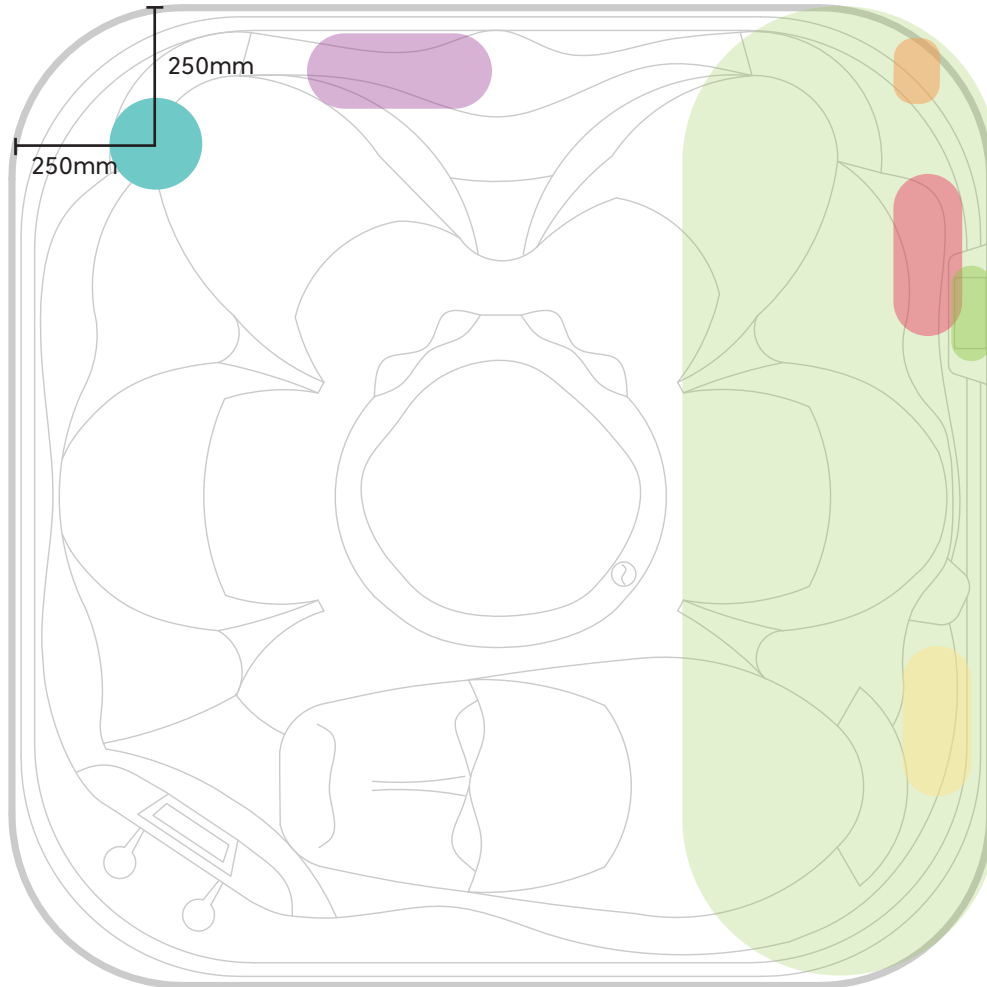









Illustration shows Fisher 5S™ spa pool model

	Equipment Bay		Drain Valve		Circulation Pump
	Keypad		Boost Pump		Heater
	Conduit Access				

\* Conduit access should be no more than 100mm high above the concrete slab.

# Fisher 5S™

## Standard Spa Cover

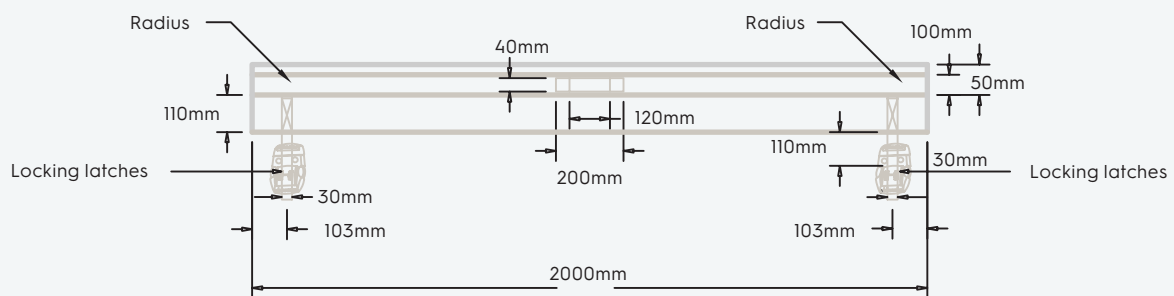
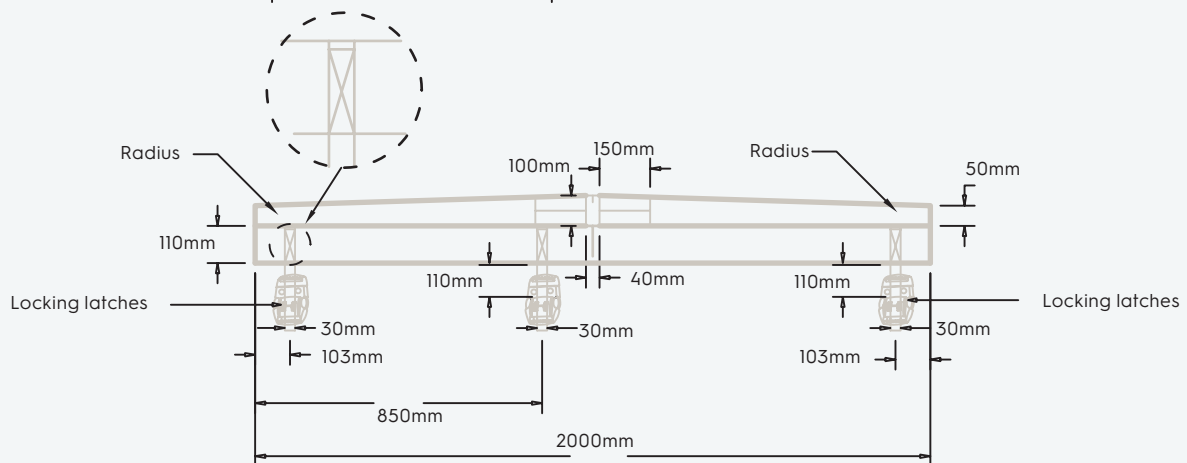
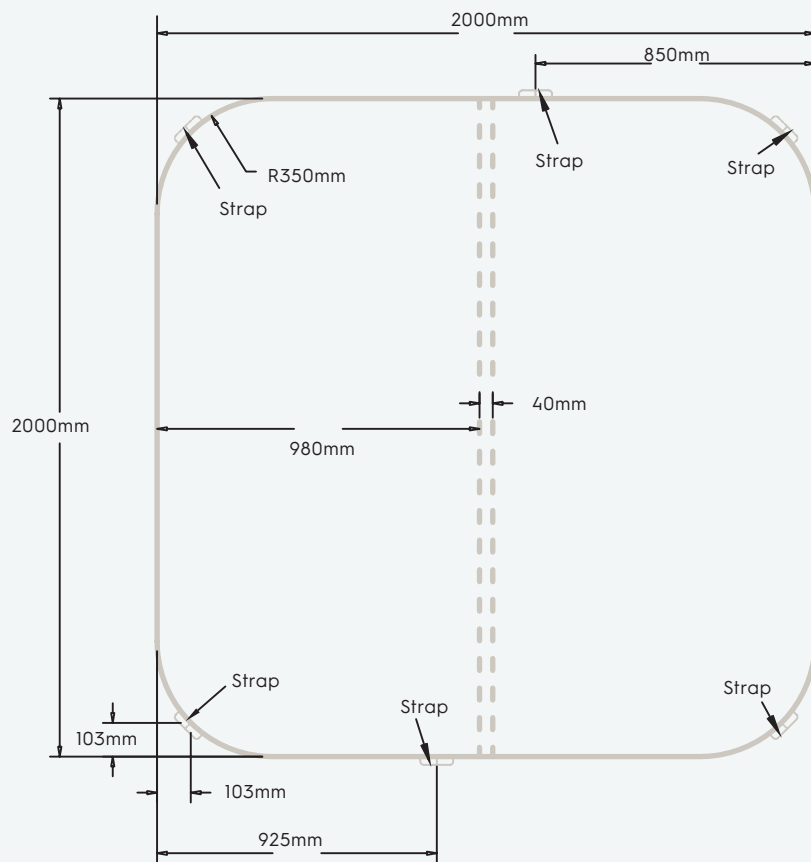

# Fisher Spas™ Limited Warranty

Vortex Leisure Pty Ltd owns the Fisher Spas™ brand

## Lifetime Warranty on Permaframe™ Frames

Vortex Leisure Pty Ltd warrants the structural integrity of the spa frame against defects in workmanship and materials for the lifetime of the spa subject to the limitations, conditions and exclusions expressed in this warranty.

## 10 year non pro rata structural warranty

Vortex Leisure Pty Ltd warrants the structure of the spa shell against defects in workmanship and materials leading to water loss from the spa for a period of 10 years from date of manufacture subject to the limitations and conditions expressed in this warranty.

## 5 year acrylic warranty

Vortex Leisure Pty Ltd warrants against the loss of water through the acrylic surface of the spa shell for a period of 5 years from date of manufacture, subject to limitations and conditions in this warranty.

## 5 year jet warranty

Vortex Leisure Pty Ltd warrants the removable spa jets to be free of manufacturing defects for a period of 5 years from date of manufacture. This warranty excludes damage by grit, sand and improper water chemistry causing corrosion of the part and is limited to supply of replacement parts after the faulty part has been returned to Vortex Leisure Pty Ltd for warranty inspection. Leaking from jets is covered by the plumbing warranty. Laminar jets have a 1 year parts only warranty.

## 5 year heater warranty

Vortex Leisure Pty Ltd warrants the heater element against defects in materials and workmanship for a period of 5 years from date of manufacture. After 1 year this warranty is limited to the supply of replacement parts and excludes labour and freight costs. This warranty does not cover damage to heaters caused by incorrect water balance resulting in the heater being subjected to abrasive/acid water.

## 5 year plumbing warranty

Vortex Leisure Pty Ltd warrants the plumbing piping and plumbing joints against defects in materials and workmanship causing leaking for a period of 5 years from date of manufacture. After 1 year this warranty is limited to the supply of replacement parts and excludes all labor and freight costs.

## 2 year pump warranty

Vortex Leisure Pty Ltd warrants the water pumps against defects in materials and workmanship for a period of 2 years from date of manufacture. After 1 year this warranty is limited to the supply of replacement parts and excludes all labour and freight costs. Damage to the pump motor caused by incorrect chemical balance will not be covered under this warranty. Vortex Leisure Pty Ltd reserves the right to request that the pump be returned for assessment before it is replaced under this warranty.

## 2 year electronic components warranty

Vortex Leisure Pty Ltd warrants electronic control systems against defects in materials and workmanship for a period of 2 years from date of manufacture. After 1 year the warranty is limited to the supply of replacement parts after the product has been assessed by either Vortex Leisure Pty Ltd or the relevant control system manufacturer.

## 1 year air blower warranty

Vortex Leisure Pty Ltd warrants the air blower against defects in materials and workmanship for a period of 1 year. This warranty will become void if the blower damage is caused by overfilling.

## 1 year thermoclad cabinet warranty

Vortex Leisure Pty Ltd warrants the thermoclad spa cabinet against defects in materials and workmanship for a period of 1 year from date of manufacture. This warranty specifically covers the structural integrity of the cabinet. The thermoclad cabinet finish is warranted to be free from defects in materials and workmanship at the time of initial delivery. Fading and weathering of the surface will occur naturally over time, and are not considered defects.

## 1 year Wifi, audio system, ozone, UV, LED light(s) warranty

Vortex Leisure Pty Ltd warrants the factory installed Wifi, audio system, UV sanitiser, Ozone sanitiser and LED Light(s) assemblies, to be free from defects in materials and workmanship for 1 year. The UV globe is a parts only warranty, if it fails within the 1 year period, a replacement globe will be sent out free of charge to be installed by the customer.

## 1 year external heat pump warranty

Vortex Leisure Pty Ltd warrants the External Heat Pump to be free from defects in materials and workmanship for 1 year. Installation is to be carried out by a qualified contractor. Failure to do so will immediately VOID this warranty. Vortex Leisure Pty Ltd reserves the right to request the return of the heat pump for assessment before it is replaced or repaired.

## 1 year spa hardcover warranty

Your Spa Cover is warranted for a period of 1 Year from the date of delivery. This warranty applies only to the structural integrity of the cover and the vinyl. Damage caused to stitching, straps or locks due to improper use of the cover will not be covered under warranty. Disposal of any cover replaced under warranty will be the owners responsibility.

## Warranty coverage

Warranty coverage begins at the delivery date. Vortex Leisure Pty Ltd only extends this warranty to the original purchaser and only if the spa has been purchased through an authorized Vortex Leisure Pty Ltd reseller. Written notice of the defect and proof of purchase must be provided to Vortex Leisure Pty Ltd or it's nominated representative within 14 days of the defect occurring. If the spa is required to be returned to Vortex Leisure Pty Ltd for rectification all freight costs shall be pre paid by the customer. Repair or replacement of any defective product is at the sole discretion of Vortex Leisure Pty Ltd. To action warranty service contact the authorized Vortex Leisure Pty Ltd reseller you purchased from. If you are unable to obtain satisfactory service from your reseller, written notification must be provided to Vortex Leisure Pty Ltd within 14 days of the defect occurring. Vortex Leisure Pty Ltd will pay the travel costs of the service agent for the first 40km from their base. Any further travel charges shall be the responsibility of the spa owner.

## Electrical connection

All electrical connections must be carried out by a qualified electrical contractor. Failure to do so will immediately VOID this warranty. The spa must be connected to a dedicated MAINS electrical supply circuit protected by a compliant earth leakage circuit breaker safety switch. Vortex Leisure Pty Ltd reserves the right to ask for proof that the spa has been installed by a qualified electrician.

## Warranty exclusions

1. Damage resulting from improper water maintenance.
2. Damage from operating the spa above 45°C.
3. Damage caused by clogged filters
4. Damage caused to the spa by improper use of spa cover and excessive exposure to sunlight.
5. Acts of God.
6. Damage caused by not installing spa on sufficient hard level surface.
7. Damage caused by incorrect electrical installation, brownouts, voltage spikes or operating spa out of +/- 10% of voltage range.
8. Warranty is not extended to filter cartridges, head rests, pump seals or drain hoses.
9. Commercial use reduces all warranties to maximum 6 months.
10. Damage caused by relocation of the spa from its original installed location.
11. Damage by termites, borer or other pests.
12. Damage caused by flooding
13. Damage caused by third party carriers.
14. Damage or corrosion to frame caused by un-repaired leaks or improper drainage.

## Limitations

This warranty is the only warranty offered by Vortex Leisure Pty Ltd and excludes any other implied or oral undertakings. Except as described above, this warranty does not cover defects or damage due to normal wear and tear, improper installation, alteration without Vortex Leisure Pty Ltd's prior written consent, accident, acts of God, misuse, abuse, commercial or industrial use of an accessory not approved by Vortex Leisure Pty Ltd, failure to follow Fisher Spas™ Pre-Delivery Instructions or Owner's Manual, or repairs made or attempted by anyone other than an authorized representative of Vortex Leisure Pty Ltd. Vortex Leisure Pty Ltd or its agents will not be liable for any incidental or consequential loss or injury. Vortex Leisure Pty Ltd will not be liable for costs associated with but not limited to building alterations, removal costs, delivery costs or labour costs associated with the replacement of a spa.

**You must check and tighten all barrel unions regularly. Failure to do so may affect your warranty.  
See your user manual for further information.**

FSW050821





**FISHER™  
SPAS**

