



CATALOGO 2026

RIVER - LAKE - SEA

**FISHING TACKLE FACTORY
MADE IN ITALY**



STOPPIONI s.n.c. Firenze ITALY
Phone 00390558739615 Prod.Effevuemme s.r.l.
E-mail: stonfo@stonfo.com Web site: www.stonfo.com

PRODUTTORE MANUFACTURER FABRICANT

 Specializzata nella produzione di articoli per ogni tipo di pesca sportiva, la Ditta Stoppioni s.n.c. opera con il suo marchio Stonfo da oltre 45 anni a livello internazionale. I prodotti Stonfo sono conosciuti ed apprezzati dai pescatori per l'alta qualità dei materiali impiegati, per l'eccellente finitura e per le soluzioni innovative che molti di essi presentano. Tutti gli articoli sono prodotti all'interno dell'azienda, dalla progettazione alla produzione fino al confezionamento finale, impiegando attrezzature particolari, macchinari sofisticati con personale altamente qualificato. La Stoppioni s.n.c. è in grado, grazie alla sua organizzazione produttiva e ad un magazzino sempre rifornito, di soddisfare le richieste dei propri clienti in tempi rapidissimi in ogni parte del mondo.

 Based in Florence, Italy, from over 45 years Stoppioni s.n.c. is specialised in the production of accessories for every type of fishing. These products are marketed under the Stonfo label through large wholesalers on a world-wide basis. Many items are patented and the company will soon be introducing others to the market as it continues to research and develop new ideas. Stonfo works with a variety of different materials in its manufacturing process and all products are entirely developed inside the company from the initial idea to the making and marketing. The company use a number of distributors so that orders to all parts of the world can be dispatched.

 Installée à Florence depuis plus de 45 ans, la Société Stoppioni est spécialisée dans la production d'accessoires pour la pêche. Tous ses produits portent la marque Stonfo, la plupart sont brevetés et chaque année ils s'enrichissent de nombreuses nouveautés. Stonfo travaille sur de nombreux matériaux et maîtrise entièrement toutes les étapes de fabrication. Stonfo utilise de nombreux distributeurs qui permettent de livrer tous les clients le plus rapidement possible partout dans le monde.



1978 Mr.Ivo Stoppioni Mr.Franco Pieri

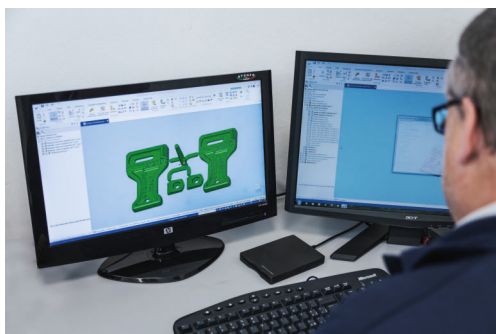

TANTE NUOVE IDEE
A LOT OF NEW IDEAS

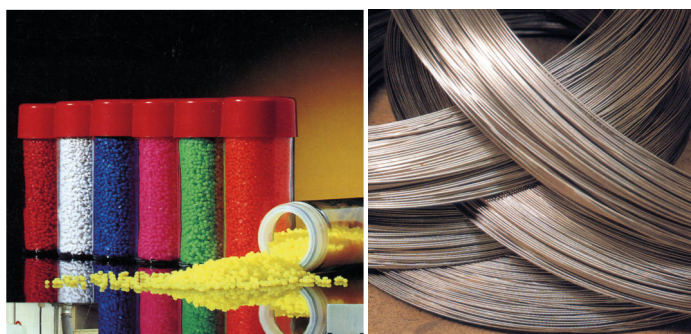

LE MIGLIORI MATERIE PRIME
THE BEST RAW MATERIALS

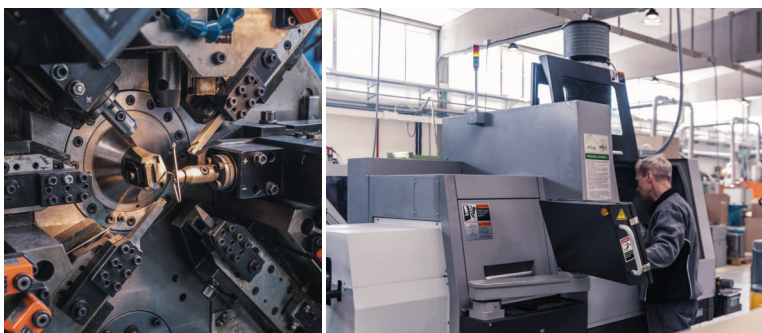

MACCHINE AD ALTA TECNOLOGIA
HIGH TECH MACHINERY



PERSONALE QUALIFICATO
SKILLED WORKERS

INDICE PER CODICE - CODE INDEX

Art 1:	Apicali stonfo (Stonfo line connectors)	pag 1
Art 2:	Apicali super stonfo (Super stonfo elastic connectors)	pag 2
Art 2-1:	Apicali super elite (Super elite elastic connectors)	pag 2
Art 2-2:	Apicali super maxi (Super maxi elastic connectors)	pag 2
Art 3-0:	Tubolari in ptfe (Ptfte tip bush)	pag 3
Art 3-00:	Tubolari in ptfe maxi (Big bore ptfe tip bush)	pag 3
Art 5:	Basi per elastico piccole (Small sizes base plugs)	pag 4
Art 5-1:	Basi regolabili per elastico Adjustable base plugs	pag 4
Art 6:	Basi per elastico grandi (Big sizes base plugs)	pag 4
Art 7:	Slamatori stonfo (Stonfo disgorgers)	pag 12-14
Art 8:	Pinzetta prensile (Plier)	pag 10
Art 10:	Aste busta da 20 pz (Float antennae 20 pcs per bag)	pag 27
Art 11:	Aste in scatolaina (Float antennae in box)	pag 28
Art 13:	Aste 20 pz lunghe (Float antennae big size 20 pcs)	pag 27
Art 15:	Aste doppio diametro (Double diameter float antennae)	pag 28
Art 16 → 17:	Slamatori mare (Sea disgorgers)	pag 13-14
Art 18-1 → 18-2:	Dosapiombo (Float shotter)	pag 9
Art 19:	Levapiombo (Shot remover)	pag 10
Art 24S:	Elastico roubaisienne (Pole elastic)	pag 7
Art 25:	Fermagall. standard (Standard float attachment)	pag 18
Art 26:	Fermagall. con girella (Swivel float attachment)	pag 18
Art 26-1:	Attacco per gall. piombati (Heavy float attachment)	pag 18
Art 27 → 27-1:	Fermagall. metallo (Metal float attachment)	pag 18
Art 29 → 30-2:	Guaina silicone (Silicone tube)	pag 33
Art 30-3:	Scoubidou silicone (Silicone float sleeves)	pag 33
Art 30-4 → 30-5:	Tubetti silicone scat. (Box clear silicon tube)	pag 33
Art 30-6 → 30-7:	Scoubidou silicone (Silicone float sleeves)	pag 33
Art 31 → 31-8:	Scoubidou pvc (Pvc float sleeves)	pag 32
Art 33:	Tappi in gomma per canne (Soft plastic pole caps)	pag 15
Art 41 → 42:	Appoggia canne da barca (Rod rest for boat)	pag 72
Art 44 → 44-1:	Portabobina (Spool holder)	pag 32
Art 46:	Winder clips	pag 31
Art 48:	Appoggia canne ercole (Ercole rod rest)	pag 26
Art 49:	Morsello per paletti (Bank stick attachment)	pag 26
Art 50:	Clitroll	pag 76
Art 54 → 57R:	Scatole per esche quadrate (Square bait boxes)	pag 34
Art 58 → 59:	Slamatori con prolunga (Extension disgorgers)	pag 12
Art 62 → 63:	Segnalatori d'abocciata (Bite indicators)	pag 57-58
Art 65 → 66:	Stonfo beads	pag 64
Art 68:	Scalettoni per elastico grosso (Base plug for big elastic)	pag 5
Art 70:	Bretelle per cinture da combat. (Combat belt braces)	pag 79
Art 71 → 72:	Perle di potenza (Boom beads)	pag 48
Art 73 → 74:	Anti tangle rigidi (Rigid anti tangle)	pag 47-48
Art 76:	Calibro per asole (Loop device)	pag 9
Art 77:	Lampade flash (Flash lamp)	pag 68
Art 79 → 80:	Redance (Thimbles)	pag 68
Art 81:	Selletta per elastico (Elastic saver)	pag 6
Art 83:	Super booms	pag 48
Art 86:	Troller worms	pag 75
Art 87:	Ago long size 2 (Long size needle)	pag 58
Art 88 → 90-1:	Pasturat. regolabili (Adjustable swimfeeders)	pag 45-46
Art 93 → 95:	Bicchierini per fionde (Xseries-Promatch pouches)	pag 22
Art 96:	Scatoline portapiombo (Sinker boxes)	pag 35
Art 97:	Scatolina porta ami (Micro size slide box)	pag 35
Art 98 → 99-1:	Scatola porta esche (Bait box)	pag 34
Art 101:	Distanziali per esche artificiali (Spacer tubes for lures)	pag 70
Art 102:	Salva ancorrette (Treble hook savers)	pag 71
Art 103:	Chiavi per lampada flash (Flash lamp spanners)	pag 68
Art 104 → 105:	Cinture per tonni (Tuna combat belts)	pag 80
Art 106:	Pasturatore scorr. gall. (Floating sliding swimfeeder)	pag 45
Art 107:	Molle per ami (Hook springs)	pag 43
Art 108:	Ammortizzatori (Spring shock absorber)	pag 43
Art 111:	Fermalenza (Winder anchors)	pag 31
Art 112 → 115:	Tappi a vite per canne (Screwed pole caps)	pag 15
Art 117 → 120:	Tappi gomma per canne (Rubber pole caps)	pag 15
Art 121 → 124:	Clip stonfo e roubaisienne (Pole clips size 1)	pag 7-8
Art 125 → 126:	Salvanelli box (Tip saver box)	pag 16
Art 127 → 130:	Cinture da combattimento (Combat belts)	pag 79
Art 131:	Tubetto restringente trasparente (Clear shrink tubing)	pag 33
Art 135 → 137:	Anelli elastici per esche (Bait elastic bands)	pag 54-55
Art 139:	Blocca esca (Bait holder)	pag 55
Art 140:	Kit blocca esca (Bait holder kit)	pag 55
Art 145 → 147:	Fermalenza kriss (Kriss winder anchors)	pag 31
Art 151 → 152:	Helicopter	pag 52
Art 153 → 154:	Salvanelli sbs tipo E (Model E sbs tip savers)	pag 16
Art 155:	Perline salvanodo (Shock absorber rubber beads)	pag 24
Art 155F:	Perline luminose in gomma (Luminous soft beads)	pag 24
Art 156:	Lead clips	pag 53
Art 158 → 169:	Perle barilotto (Hard beads)	pag 23-24
Art 170:	Aste forate 20 pz (Hollow float antennae 20 pcs bag)	pag 28
Art 171:	Gabbiette portaesca gr 5 (Frame squid lure gr 5)	pag 74
Art 172:	Easy snap	pag 62
Art 173:	Gabbiette portaesca gr5+25(Frame squid lure gr5+25)	pag 74
Art 175:	Totnare flash (Luminous squid lure)	pag 74
Art 176 → 180:	Pasturatori legering (Legering swimfeeders)	pag 46
Art 186:	Segnafilo (Line signal)	pag 42
Art 187:	Apicali over size (Over size elastic connectors)	pag 2
Art 188 → 190:	Pasturatori legering regolabili (Swimfeeders)	pag 46
Art 191 → 192:	Anelli per finali (Lure and trace holders)	pag 72
Art 193 → 194:	Pasturatori aperti (Open end swimfeeders)	pag 47
Art 199:	Pasturatori aperti gr 30 (Open end swimfeeders)	pag 47
Art 200:	Microgancio (Micro snap)	pag 62
Art 204:	Split rings light type	pag 69
Art 205 → 207:	Gomma galleggiante barrette (Bouyant rig foam)	pag 57
Art 209 → 209-1S:	Gommino salvanodo (Shock absorber)	pag 33-34
Art 210:	Gomma galleggiante (Bouyant rig foam)	pag 56
Art 211 → 218:	Perle tonde foro grande (Big bore hard beads)	pag 24
Art 219 → 220:	Gabbiette mini (Mini frame squid lure)	pag 74
Art 221:	Bait snap	pag 62
Art 222:	Sacchetti pva 70X110 (Pva bait bags 70X110)	pag 54
Art 223/15 → 223-1/34:	Aghi passafilo (Line threading needles)	pag 59
Art 223-2/12 → 223-3/20:	Aghi per esche (Bait needles)	pag 59
Art 224:	Speedy lock per palamito (Speedy lock longline fishing)	pag 73
Art 224-3:	Nottolino speedy lock (Snood connector speedy lock)	pag 74
Art 225 → 228:	Sacchetti pva (Pva bait bags)	pag 54
Art 229-1:	Attacco micro per finali (Micro paternoster)	pag 65
Art 230:	Sea booms	pag 48
Art 231:	Baby magnete (Baby magnetic box)	pag 37
Art 232:	Apicali elite (Elite line connectors)	pag 1
Art 233S:	Magnetic box	pag 37

NEW

Art 235:	Slamatori elite (Elite disgorgers)	pag 12-14
Art 236 → 236-1:	Sonde elite (Plummet)	pag 17
Art 236L:	Sonda light (Light type plummet)	pag 17
Art 237:	Perline con foro (Bored beads)	pag 23
Art 238:	Punzoni forabolies (Boilie punch)	pag 50
Art 239:	Conetti in gomma (Coniform rubber tails)	pag 53
Art 240:	Lubrificante per elastico (Elastic lubricant)	pag 7
Art 241:	Tappi a vite per canne (Screwed plastic pole caps)	pag 15
Art 242:	Scatole standard e lusso (Standard & De luxe boxes)	pag 36
Art 244:	Attacco micromatch (Micro rig connector)	pag 65
Art 245 → 245-2:	Filo elastico per esche (Baits elastic line)	pag 57
Art 245-3:	Filo elastico per boilie (Boilie elastic)	pag 54
Art 246:	Bicchierino maxi (Maxi pouch)	pag 22
Art 247:	Fermagall. scorrevoli (Slider float attachment)	pag 19
Art 248S:	Super magnete (Super magnetic box)	pag 37
Art 249:	Ago micro (Special micro needle)	pag 60
Art 250:	Bait clip	pag 63
Art 251:	Infilia elastico (Elastic threader)	pag 4
Art 252:	Slamatori little (Little disgorgers)	pag 11
Art 253:	Perline arcobaleno (Colored round beads)	pag 23
Art 254:	Trapano fora esche ø 6 mm (Bait drill ø 6 mm)	pag 49
Art 255:	Fermagalleggianti maxi (Maxi float attachment)	pag 19
Art 256:	Portastarlight (Starlight holder)	pag 57
Art 257:	Gommino salvanodo morbido (Soft shock absorber)	pag 34
Art 258:	Mini striscio (Anti tangle bombs)	pag 17
Art 258-1:	Maxi striscio (Anti tangle bombs)	pag 17
Art 259S:	Doppio magnete (Double magnetic box)	pag 37
Art 260:	Triplo attacco (Triple paternoster)	pag 65
Art 261:	Attacco jolly (Jolly connector)	pag 48
Art 262:	Attacco big (Big paternoster)	pag 66
Art 263:	Sgancio (Clip release)	pag 77
Art 264:	Multisgancio (Special clip release)	pag 77
Art 266:	Gomme di ricambio pinze traina (Spare gripper pads)	pag 78
Art 267S:	Orange magnetic	pag 37
Art 268:	Fast connector long arm (Deep fishing paternoster)	pag 66
Art 269:	Fast connector (Special paternoster)	pag 65
Art 270S → 271S:	Light magnetic boxes	pag 37
Art 272:	Full stop	pag 43
Art 273:	Slamatori match (Match disgorgers)	pag 12
Art 274 → 275:	Scatole portapiombo 5 scomparti (Sinker boxes)	pag 35
Art 276:	Molla di stop (Spring stop)	pag 67
Art 277:	Elastico ring colorato (Elastic ring fluo colours)	pag 11
Art 278:	Elastico ring nero (Elastic ring black colour)	pag 11
Art 279 → 280:	Secchielli (Bait buckets)	pag 34
Art 281 → 282:	Slamatori standard (Standard disgorgers)	pag 11
Art 283:	Fermalenza lusso (De luxe winder anchors)	pag 31
Art 284:	Gancio (Clip release holder)	pag 77
Art 285:	Perline elite (Elite beads)	pag 23
Art 290:	Elastici per fionde (Elastics for catapults)	pag 22
Art 291:	Bicchierini per fionde (Pouches for catapults)	pag 22
Art 291-4:	Bicchierino reticolare (Pouches for catapults)	pag 3
Art 292:	Apicali super zero (Super zero elastic connectors)	pag 2
Art 293:	Metal ring	pag 51
Art 294:	Blocca boilie V (Boilie stop)	pag 50
Art 295:	Ago per boilies (Boilie needle)	pag 49
Art 296:	Blocca boilie S (Boilie stop)	pag 50
Art 300:	Tubo restringente (Shrink tubing)	pag 33
Art 301:	Tubetto in pvc (Pvc tubing)	pag 32
Art 302:	Infilia filo (Line threader)	pag 43
Art 303:	Tubetto gomma fluo (Fluorescent soft tubing)	pag 74
Art 303-1:	Tubetto gomma fosforo (Phosphorescent soft tubing)	pag 75
Art 304:	Kit alette (Flights kit)	pag 28
Art 305:	Kit aste doppio diametro (Antennae kit)	pag 28
Art 306:	Fionda standard (Standard catapult)	pag 19
Art 307:	Fermagalleggianti stop (Stop float attachment)	pag 18
Art 308:	Fora boilies (Boilies drill)	pag 49
Art 309:	Apicali superone (Superone elastic connectors)	pag 2
Art 310:	Scaletta regolabile (Adjustable elastic tensioner)	pag 5
Art 311 → 313:	Fionde twin colour (Twin colour catapults)	pag 19-20
Art 315:	Matassina per aguglie (Skein lure)	pag 75
Art 316:	Perline tonde morbide (Round rubber beads)	pag 24
Art 317 → 327:	Elastici per fionde (Elastics for catapults in bulk)	pag 22
Art 330:	Cono regolabile (Adjustable conic elastic tensioner)	pag 4
Art 332:	Slamatori big (Big disgorgers)	pag 13
Art 336:	Slamatori big annocatore (Big disgorgers with priest)	pag 13
Art 337 → 338:	Galleggianti pasturatore (Feeder float)	pag 44
Art 339:	Fionda twin colour alluminio (Aluminium catapult)	pag 21
Art 340 → 341:	Fionde maxi (Maxi catapult)	pag 21
Art 342:	Battipalo (Stick driver)	pag 25
Art 344:	Appoggia canne a V (Soft V rod rest)	pag 25
Art 345:	Appoggia canne a V basculante (De luxe V rod rest)	pag 26
Art 346:	Fast connector light (Special paternoster type light)	pag 65
Art 348:	Appoggia canne tipo L (Rod rest type L)	pag 26
Art 349:	Appoggia canne tipo E (Rod rest type E)	pag 26
Art 350:	Appoggia canne tipo F (Rod rest type F)	pag 25
Art 351:	Appoggia canne tipo B (Rod rest type B)	pag 25
Art 352:	Appoggia canne tipo C (Rod rest type C)	pag 25
Art 354-1 → 355-2:	Aghi per inneschi (Baiting needles)	pag 58
Art 356 → 358:	Fionde pro match (Pro match catapult)	pag 20
Art 359:	Pastur. scorr. piccolo (Small size sliding swimfeeder)	pag 45
Art 360:	Fermagall. scorrevoli match (Match float attachment)	pag 19
Art 361:	Guaina colorata fluo (Multifunction fluorescent tubing)	pag 29
Art 362:	Anti tangle metallo (Stainless steel anti tangle)	pag 48
Art 363:	Boccola per guadini tipo FO (FO landing net bushes)	pag 17
Art 364:	Boccola per guadini tipo MO (MO landing net bushes)	pag 17
Art 365 → 366:	Portascatole ripiegabile (Folding bait tray)	pag 35
Art 367:	Combi (Combo system)	pag 6
Art 368:	Tubolari in ptfe per interno (Internal ptfe tip bush)	pag 3
Art 369:	Infilia bombarda (Line threader needle)	pag 43
Art 370 → 372:	Filo elastico magnum (Magnum baits elastic line)	pag 57
Art 374:	Boccola per guadini tipo MA (MA landing net bushes)	pag 17
Art 375 → 377:	Salvanelli sbs tipo A (Model A sbs tip savers)	pag 15
Art 378:	Segnafilo intercambiabile (Interchangeable line signal)	pag 42
Art 379:	Filo pva idrosolubile (Pva string)	pag 54
Art 380 → 381:	Tende per esche (Baits tents)	pag 35
Art 382:	Blocca bicchierino fionde (Spare connector for catapults)	pag 22
Art 383:	Blocca elastici fionde (Spare connectors for catapults)	pag 21
Art 385 → 388:	Tubetto gomma fluo (Fluor soft rubber tubing)	pag 75
Art 390 → 392:	Salvanelli sbs tipo B (Tip savers B type)	pag 16
Art 394:	Tubolari in ptfe colorati (Colored ptfe tip bush)	pag 3
Art 399:	Asta per cannicchi (Razor shell prong)	pag 74
Art 400 → 401:	Salvanelli sbs tipo C (Tip savers C type)	pag 16
Art 403:	Alette per galleggianti (Dart flights for floats)	pag 27

Art 405→409: Fionde x series (X series catapult)	pag 20
Art 420→422: Pesi intercambiabili (Interchangeable weights)	pag 18
Art 423: Appoggia canne tulipano 2 ("Tulipano 2" rod rest)	pag 26
Art 424: Aghi tubolari senza punta (Tubular needle without tip)	pag 59
Art 425: Conoplus (Conoplus system)	pag 5
Art 426: Estrattore conoplus (Conoplus extractor)	pag 6
Art 428: Aghi tubolari senza punta (Tubular needle without tip)	pag 59
Art 429: Slamatori bicolore (High quality disgorgers)	pag 13
Art 430: Tappi roubaisienne (Pole end protectors)	pag 15
Art 433: Easy snap maxi	pag 73
Art 435: No nodo (No knot)	pag 69
Art 436: Perle tonde policarbonato ø 6 (Polycarbonate beads)	pag 23
Art 437: Lead clip maxi	pag 53
Art 448: Lega ami (Hook tyer)	pag 8
Art 449: Supporto di montaggio (Line rest)	pag 64
Art 450: Anellini per scorrevoli 20 pz (Slider float rings 20 pcs)	pag 28
Art 451: Anellini per scorr. PL 20 pz (Slider float rings PL 20 pcs)	pag 29
Art 452: Anellini inox scorr. 20pz (Innox float slider rings 20pcs)	pag 28
Art 453: Stonfo beads matchplus	pag 64
Art 454→455: Aghi testa rossa (Red point needles)	pag 59
Art 456: Aghi bibi testa rossa (Peanut worm needles)	pag 60
Art 458: Back lead clip	pag 54
Art 459: Pasterello (Soft bait spring)	pag 44
Art 460: Aghi testa rossa arenicola (Lugworm needle)	pag 60
Art 461: Infila elastico in bobina (Elastic threader in spool)	pag 5
Art 465: Pro jigging solid rings	pag 69
Art 466: Outrigger clip	pag 78
Art 467: Under size needles	pag 49
Art 468: Split rings strong type	pag 69
Art 471: Scatoline componibili (Modular boxes)	pag 35
Art 472: Slamatori annocatore (Trout disgorgers with priest)	pag 13
Art 473: Speed snap	pag 62
Art 474: Braccioli (Rig connectors)	pag 66
Art 485: Anti tangle metallo maxi (Stainless steel anti tangle)	pag 48
Art 486→487: Bilancine (Scales)	pag 32
Art 489: Pinze per split rings (Split ring pliers)	pag 68
Art 490→492: Pasturatori maxi (Maxi swimfeeders)	pag 46
Art 493: Coppette stonfo (Pole feeding cups)	pag 7
Art 505: Mini striscio bu. da 2 pz (Anti tangle bombs 2 per bag)	pag 17
Art 506: Maxi striscio bu. da 2 pz (Anti tangle bombs 2 per bag)	pag 17
Art 507→509: Pasturatori aperti maxi (Open end swimfeeders)	pag 47
Art 510: Pasturatore da barca (Boat feeder)	pag 67
Art 511→512: Holo lure eyes	pag 40
Art 513: 3D fishscale adhesive tape	pag 41
Art 514: Light boxes	pag 36
Art 515: Aghi plustec (Plustec needles)	pag 60
Art 518: Colla cianox (Cianox glue)	pag 63
Art 519: Perlina foro calibrato (Beads with calibrated bores)	pag 63
Art 520: Botton service magnetico	pag 40
Art 521→522: Perle max morbide (Max rubber beads)	pag 25
Art 524: Realistic eggs	pag 40
Art 525: Botton service	pag 39
Art 526: Botton service doppio	pag 39
Art 529: Serbidora stonfo (Bait tray stonfo)	pag 56
Art 530: Rotoknotter	pag 76
Art 532: Wind-on needles	pag 76
Art 533: Safety cord	pag 39
Art 534→535: Holo fish	pag 41
Art 536: Scatole F type (F type boxes)	pag 36
Art 537: Pesciometro (Measuring tape)	pag 81
Art 538→539: Fluo lure eyes	pag 41
Art 540: Livrea fluo adhesive tape	pag 41
Art 543: Setaccio cm 15x15 (Riddle)	pag 34
Art 544: Imbobinatore (Spooling station)	pag 49
Art 545→546: Attrattore beads	pag 25
Art 548: Tiranodo (Tighten knot)	pag 71
Art 549: Olio lubrificante (Lubricant oil)	pag 80
Art 550: Aghi Ø 0,8 testa bianca (White point needle Ø 0,8)	pag 59
Art 554: Reel lube grease	pag 80
Art 568: Serbidora jolly (Bait tray jolly)	pag 56
Art 569: Serbidora barca (Bait tray boat)	pag 72
Art 570: Palo snodato inox (Adjustable stainless steel base)	pag 72
Art 571: Giunto regolabile (Bank stick connector)	pag 27
Art 572: Moschettoni R type (R type snaps)	pag 69
Art 573: Moschettoni V type (V type snaps)	pag 69
Art 574: Multimaggot	pag 43
Art 580: Tubolari in ptfte small hole (Small hole ptfte bush)	pag 3
Art 581: Tubolari in ptfte 2nd sections (2nd sections ptfte bush)	pag 3
Art 582→583: Clip beads	pag 64
Art 584: Coprinodo (Knot cover)	pag 38
Art 587: Salvanelli sbs tipo A mis 4 (Model A sbs tip saver size 4)	pag 15
Art 588→589: Nose ring	pag 75-76
Art 589-1: Nose ring maxi	new 1
Art 592: Levone (Big size shot remover)	pag 10
Art 595: Tubolari ptfte int. foro grande (int. pole bushes big bore)	pag 3
Art 596: Anelli per esche magnum (Magnum bait elastic bands)	pag 55
Art 600: Synthetic wings	pag 42
Art 601: Synthetic film	pag 41
Art 602: Fermabobina (Spool holder)	pag 9
Art 603: Collana stonfo (Fishing neck lanyard)	pag 40
Art 604: Calibrone stonfo	pag 9
Art 606: Rastrello (Rake)	pag 17
Art 607→608: Teleferica (Rock fishing connector)	pag 63
Art 615: Slamatori tubetech (Tubetech disgorgers)	pag 15
Art 617→618: Command grip	pag 81
Art 620: Attacco roto (Roto connector)	pag 44
Art 621: Attacco per esche siliconiche (Soft lure springs)	pag 71
Art 622: Botton service mini	pag 39
Art 625: Foam strike indicators	pag 42
Art 627→628: Portafinali 200 e 300	pag 10
Art 631: Magnetic rod holder	pag 42
Art 632: Pasturatore minibomb (Minibomb swimfeeder)	pag 45
Art 636: Quicklink rounded shape	pag 70
Art 637: Wirelink clip	pag 70
Art 638: Quicklink elliptical shape	pag 70
Art 640→641: Avvolgilenza a vela (Flat float winders)	pag 31
Art 642: Lente a ventosa (Magnifying glass suction cup base)	pag 40
Art 643: Giunto a ventosa (Angle lock connector - sucker base)	pag 27
Art 644: Kit di bloccaggio (Accessories clamp)	pag 27
Art 652: Needles set	pag 49
Art 660: Super jaw disgorger	pag 14
Art 662: Coni anti tangle (Anti tangle sleeves)	pag 53

NEW

Art 663: Attacco roto snap (Roto snap connector)	pag 66
Art 664: Attacco roto maxi (Maxi roto connector)	pag 44
Art 665: Slama releaser	pag 14
Art 669: Kit line connector	pag 53
Art 672→673: Needle boxes cm22 - cm22-32-42-52	pag 61
Art 676→677: Needle kit 20-30	pag 61
Art 679: Stonfo rod holder	pag 39
Art 680: Run rig kit	pag 52
Art 681: Buffer beads	pag 52
Art 682: Needle XXL 110	pag 49
Art 683: Hook stops	pag 51
Art 685→686: Pro-diver1-2	pag 78
Art 687: Apicale softlink (Softlink elastic connector)	pag 2
Art 688: Line aligner Stonfo	pag 51
Art 690: Fionda maxi 3 (Maxi 3 catapult)	pag 21
Art 691: Bicchierino maxi cone (Maxi cone pouch)	pag 22
Art 694: Ptfte curved	pag 6
Art 697: Bait bander tool	pag 55
Art 698: Selletta maxi (Maxi elastic saver)	pag 6
Art 701: Lure snaps	pag 70
Art 702: Bait spike	pag 50
Art 703: Pasturatore big barca (Boat feeder big)	pag 67
Art 706: Coprinodo maxi (Knot cover maxi)	pag 38
Art 708: Nipper stonfo	pag 38
Art 710: Connector beads	pag 52
Art 712: Baiting twin needle	pag 58
Art 713: Anti tangle light	pag 47
Art 714: Bullet	pag 71
Art 715: Pro link	pag 62
Art 716: Coprinodo slim	pag 38
Art 717: Synthetic corn	pag 51
Art 718: Synthetic maggots	pag 51
Art 719: Synthetic casters	pag 51
Art 720: Anti tangle micro	pag 47
Art 721: Slider snap	pag 44
Art 722: Bait bands tris	pag 55
Art 724: Dacron connector kit	pag 1
Art 728: Pellet stopper	pag 50
Art 730: Lure-line holder	pag 11
Art 731: Float caps	pag 29
Art 732: Box 260x190x26 SC. 1	pag 30
Art 733: Box + winders 18x1,2 cm mini	new 5
Art 734: Box + winders 18 x 1,6 cm narrow	new 5
Art 735: Box + winders 18x2,0 cm wide	new 5
Art 736: Box + winders 25x1,8 cm narrow	new 5
Art 737: Box + winders 25x2,5 cm wide	new 5
Art 738: Micro loop tyers	pag 8
Art 739: Box + winders 25x1,4 cm mini	new 5
Art 742: Box 260x190x26 SC.6	pag 30
Art 743: Box 260x190x26 SC. 12	pag 30
Art 747: Micro split ring plier	new 4
Art 748: Precision plummets	new 4
Art 749: Catalina needle	new 4
Art 751: Box + winders 20x1,3+18x1,2 cm mini	new 5
Art 752: Box + winders 20x1,6+18x1,6 cm narrow	new 5
Art 753: Box + winders 22x1,4+18x1,2 cm mini	new 5
Art 754: Box + winders 22x1,8+18x1,6 cm narrow	new 5
Art 755: Pole winder labels 79x8 mm	new 6
Art 756: Round winder labels Ø 46 mm	new 6
Art 757: Round winder labels Ø 58 mm	new 6
Art 758: Micro shot plier	new 4
Art 759: Micro plier	new 2
Art 760: Super knot tightener	new 1
Art 761: Ghost bait bands	new 3
Art 762: Spool bands	new 2
Art 765: Tataki snap	new 1
Art 766: Winder connector	new 3
Art 767: Lead clip mini	new 2
Art 768: Guardian clip	new 2
Art 9218R: Avvolgilenza a rete (Net winders)	pag 31
Art 9408S→9535S: Avvolgilenza strette (Narrow winders)	pag 29
Art 9408SS→9535LS: Avvolgilenza bu. da 5 pz (Winders 5 pcs)	pag 30
Art 9408L→9522M: Avvolgilenza larghe (Wide winders)	pag 29
Art 9514N→9525N: Avvolgilenza mini (Extra narrow winders)	pag 29
Art 9522L→9535L: Avvolgilenza extra larghe (XL winders)	pag 30
Art 9525→9535: Avvolgilenza normali (Normal winders)	pag 30

NEW
NEW
NEW
NEW
NEW
NEW
NEW

INDICE ALFABETICO - ALPHABET. INDEX

Aghi per innesco (Baiting needles).....	pag 58-59-60
Ago long size 2 (Long size needle).....	pag 58
Ago per boilies (Boilie needle).....	pag 49
Alette per galleggianti (Flights for floats).....	pag 27
Ammortizzatori (Spring shock absorber).....	pag 43
Anelli elastici per esche (Bait elastic bands).....	pag 54-55
Anelli per finali (Lure and trace holder).....	pag 72
Anellini per galleggianti (Float rings).....	pag 28-29
Anti tangle	pag 47-48
Apicali (Line and elastic connectors).....	pag 1-2
Appoggia canne (Rod rests).....	pag 25-26
Appoggia canne da barca (Rod rest for boat).....	pag 73
Asta per canalicchi (Razor shell prong).....	pag 74
Aste per galleggianti (Float antennae).....	pag 27-28
Attacco big (Big paternoster).....	pag 66
Attacco jolly (Jolly connector).....	pag 48
Attacco micro per finali (Micro paternoster).....	pag 65
Attacco micromatch (Micro rig connectors).....	pag 65
Attacco per esche siliconiche (Soft lure springs).....	pag 71
Attacco per galleggianti piombati (Float attachment).....	pag 18
Attacco roto (Roto connector).....	pag 44
Attacco roto snap (Roto snap connector).....	pag 66
Attractor beads	pag 25
Avvolgilenza (Winders).....	pag 29-30-31

Baby magnete (Baby magnetic box).....	pag 37
Back lead clip	pag 54
Bait bander tool	pag 55
Bait bands tris	pag 55
Bait clip	pag 63
Bait snap	pag 62
Bait spike	pag 50
Baiting twin needle	pag 58
Basi per elastico (Base plugs).....	pag 4
Basi regolabili (Adjustable bases).....	pag 4
Battipalo (Stick driver).....	pag 25
Bicchierini per fionde (Catapult pouches).....	pag 22
Bicchierino reticolare per fionde (Catapult poche).....	new 3
Bilancine (Scales).....	pag 32
Blocca bicchierino fionde (Spare connector for pouches).....	pag 22
Blocca boilies (Boilie stop).....	pag 50
Blocca elastici per fionde (Spare connector for catapults).....	pag 21
Blocca esca (Bait holder).....	pag 55
Boccole per guadini (Landing net bushes).....	pag 17
Botton service	pag 39-40
Box 260x190x26	pag 30
Box + winders	new 5
Braccioli (Rig connectors).....	pag 66
Bretelle per cinture da combattimento (Combat belt braces).....	pag 79
Buffer beads	pag 52
Bullet	pag 71

Calibro per asole (Loop device).....	pag 9
Calibrone stonfo	pag 9
Catalina needle	new 4
Chiavi per lampada flash (Flash lamp spanners).....	pag 68
Cinture da combattimento (Combat belts).....	pag 79-80
Clip beads	pag 64
Clip roubaisienne e stonfo	pag 7-8
Clip troll	pag 77
Colla cianox (Cianox glue).....	pag 63
Collana stonfo (Fishing neck lanyard).....	pag 40
Combi (Combo system).....	pag 6
Command grip	pag 81
Conetti in gomma (Coniform rubber tails).....	pag 53
Coni anti tangle (Anti tangle sleeves).....	pag 53
Connector beads	pag 52
Cono regolabile (Adjustable conic elastic tensioner).....	pag 4
Conoplus	pag 5
Coppette stonfo (Pole feeding cups).....	pag 7
Coprinodo (Knot cover).....	pag 38

Dacron connector kit	pag 1
Distanziali per esche artificiali (Spacer tubes for lures).....	pag 70
Doppio magnete (Double magnetic box).....	pag 37
Dosapiombo (Float shotter).....	pag 9

Easy snap	pag 62-73
Elastic ring	pag 11
Elastici per fionde (Replacement elastics for catapults).....	pag 22
Elastico roubaisienne (Roubaisienne elastic).....	pag 7
Estrattore conoplus (Conoplus extractor).....	pag 6

Fast connector (Paternosters).....	pag 65-66
Fermabobina (Spool holder).....	pag 9
Fermagalleggianti (Float attachments).....	pag 18-19
Fermalenza (Winder anchors).....	pag 31
Filo elastico per boilie (Boilie elastic).....	pag 54
Filo elastico per esche (Baits elastic line).....	pag 57
Filo pva idrosolubile (Pva string).....	pag 54
Fionde (Catapults).....	pag 19-20-21
Float caps	pag 29
Fluo lure eyes	pag 41
Foam strike indicators	pag 42
Fora boilies (Boilies drill).....	pag 49
Full stop	pag 43

Gabbiette portaesca (Frame squid lure).....	pag 74
Galleggianti pasturatori (Feeder floats).....	pag 44
Gancio (Clip release holder).....	pag 77
Ghost bait bands	new 3
Giunto a ventosa (Angle lock connector with sucker base).....	pag 27
Giunto regolabile (Bank stick connector).....	pag 27
Gomma galleggiante (Buoyant rig foam).....	pag 56-57
Gomme di ricambio pinze traina (Spare gripper pads).....	pag 78
Gommino salvanodo (Shock absorber).....	pag 33-34
Grasso silicone (Silicone lubricant).....	pag 80
Guaina colorata fluo (Multifunction fluorescent tubing).....	pag 29
Guaina silicone (Silicone tube).....	pag 33
Guardian clip	new 2

Helicopter	pag 52
Holo fish	pag 41
Holo lure eyes	pag 40
Hook stops	pag 51

Imbobinatore (Spooling station).....	pag 49
Infila bombarde (Line threader needle).....	pag 43
Infila elastico (Elastic threader).....	pag 4-5
Infila filo (Line threader).....	pag 43

Kit alette (Flights kit).....	pag 28
Kit aste doppio diametro (Antennae kit).....	pag 28
Kit blocca esca (Bait holder kit).....	pag 55
Kit di bloccaggio (Accessories clamp).....	pag 27
Kit line connector	pag 53

Lampade flash (Flash lamps).....	pag 68
Lead clips	pag 53
Lead clip mini	new 2
Lega ami (Hook tyer).....	pag 8
Lente a ventosa (Magnifying glass with suction cup base).....	pag 40
Levapiombo (Shots remover).....	pag 10
Levone (Big size shots remover).....	pag 10
Light boxes	pag 36
Light magnetic boxes	pag 37
Line aligner stonfo	pag 51
Livrea fluo adhesive tape	pag 41
Lubrificante per elastico (Elastic lubricant).....	pag 7
Lure-line holder	pag 11
Lure snaps	pag 70

Magnetic box	pag 37
Magnetic rod holder	pag 42
Matassina per aguglie (Skein lures).....	pag 75
Maxi strisci (Anti tangle bombs).....	pag 17
Metal ring	pag 51
Micro loop tyers	pag 8
Micro plier	new 2
Micro split ring plier	new 4
Micro shot plier	new 4
Microgancio (Micro snap).....	pag 62

Mini strisci (Anti tangle bombs)..... pag 17
Molla di stop (Spring stop)..... pag 67
Molle per ami (Hook springs)..... pag 43

Morsetto per paletti (Bank stick attachment)..... pag 26
Moschettoni (Snaps)..... pag 69
Multimaggot..... pag 43
Multisgancio (Special clip release)..... pag 77

Needle XXL 110..... pag 49
Needle boxes..... pag 61
Needle kits..... pag 61
Needles set..... pag 49
Nipper stonfo..... pag 38
No nodo (No knot)..... pag 69
Nose ring..... pag 75-76
Nose ring maxi..... new 1
Nottolino per speedy lock (Snood connector for speedy lock)..... pag 74

Olio lubrificante (Lubricant oil)..... pag 80
Orange magnetic..... pag 37
Outrigger clip..... pag 78

Palo snodato inox (Adjustable stainless steel base)..... pag 72
Pasterello (Soft bait springs)..... pag 44
Pasturatori barca (Boat feeder)..... pag 67
Pasturatori (Swimfeeders)..... pag 45-46-47
Pellet stopper..... pag 50
Perle di potenza (Boom beads)..... pag 48
Perle e perline (Beads)..... pag 23-24-25
Perline foro calibrato (Beads with calibrated bores)..... pag 63
Pesciometro (Measuring tape)..... pag 81
Pesi intercambiabili (Interchangeable weights)..... pag 18
Pinze per split rings (Split ring pliers)..... pag 68
Pinzetta prensile (Plier)..... pag 10
Pole winder labels 79x8 mm..... new 6
Portabobina (Spool holder)..... pag 32
Portafinali 200 e 300..... pag 10
Portascatole ripiegabile (Folding bait tray)..... pag 35
Portastarlight (Starlight holder)..... pag 57
Precision plummets..... new 4
Pro-divers..... pag 78
Pro jigging solid rings..... pag 69
Pro link..... pag 62
Ptfe curved..... pag 6
Punzoni foraboilies (Boilie punch)..... pag 50

Quicklink elliptical shape..... pag 70
Quicklink rounded shape..... pag 70

Rastrello (Rake)..... pag 17
Realistic eggs..... pag 40
Redance (Thimbles)..... pag 68
Reel lube grease..... pag 80
Rotoknotter..... pag 76
Round winder labels..... new 6
Run rig kit..... pag 52

Sacchetti pva (Pva bait bags)..... pag 54
Safety cord..... pag 39
Salva ancorette (Treble hook savers)..... pag 71
Salvanelli (Tip savers)..... pag 15-16
Scaletta regolabile (Adjustable elastic tensioner)..... pag 5
Scalettone per elastico grosso (Base plug for big elastic)..... pag 5
Scatole F type (F type boxes)..... pag 36
Scatole lusso (De luxe boxes)..... pag 36
Scatole per esche (Square bait boxes)..... pag 34
Scatole porta esche (Bait boxes)..... pag 34
Scatole portapiombo (Sinkers boxes)..... pag 35
Scatole standard (Standard boxes)..... pag 36
Scatolina porta ami (Micro size slide box)..... pag 34
Scatoline componibili (Modular boxes)..... pag 35
Scatoline portapiombo (Sinkers boxes)..... pag 35
Scoubidou pvc (Pvc float sleeves)..... pag 32
Scoubidou silicone (Silicone float sleeves)..... pag 33
Sea booms..... pag 48
Secchielli (Bait buckets)..... pag 34

Segnafile (Line signal)..... pag 42
Segnalatori d'abboccata (Bite indicators)..... pag 57-58
Selletta per elastico (Elastic saver)..... pag 6
Serbodore (Bait trays)..... pag 56-72
Setaccio (Riddle)..... pag 34
Sgancio (Clip release)..... pag 77
Slama releaser..... pag 14
Slamatori (Disgorgers)..... pag 11-12-13-14-15
Slider snap..... pag 44
Sonde (Plummets)..... pag 17
Speed snap..... pag 62
Speedy lock per palamito (Speedy lock for longline fishing)..... pag 73
Split rings..... pag 69
Spool bands..... new 2
Stonfo beads..... pag 64
Stonfo rod holder..... pag 39
Super booms..... pag 48
Super jaw disgorgor..... pag 14
Super knot tightener..... new 1
Super magnete (Super magnetic box)..... pag 37
Supporto di montaggio (Line rest)..... pag 64
Synthetic casters..... pag 51
Synthetic corn..... pag 51
Synthetic film..... pag 41
Synthetic maggots..... pag 51
Synthetic wings..... pag 42

Tappi per canne (Pole caps)..... pag 15
Tappi roubaisienne (Pole end protectors)..... pag 15
Tataki snap..... new 1
Teleferica (Rock fishing connector)..... pag 63
Tende per esche (Bait tents)..... pag 35
Tiranodo (Tighten knot)..... pag 71
Totanare flash (Luminous squid lure)..... pag 74
Trapano fora esche Ø 6 mm (Bait drill)..... pag 49
Triplo attacco (Triple paternoster)..... pag 65
Troller worms..... pag 75
Tubetti silicone in scatola (Box clear silicone tube)..... pag 33
Tubetto gomma (Soft tubing)..... pag 74-75
Tubetto in pvc (Pvc tubing)..... pag 32
Tube restringente (Shrink tubing)..... pag 33
Tubolari in ptfe (Ptfe tip bushes)..... pag 3

Under size needle..... pag 49

Wind-on needles..... pag 76
Winder clips..... pag 31
Winder connector..... new 3
Wirelink clip..... pag 70

3D fishscale adhesive tape..... pag 41

Art.760 SUPER KNOT TIGHTENER

Utensile studiato per serrare agevolmente il nodo dell'amo, della girella o dell'asola. La sua forma ergonomica permette di effettuare una notevole forza. Prodotto con un materiale plastico molto resistente di 9 mm di spessore. È adatto sia per trecce che monofili in nylon di grande diametro. Utile anche per recuperare il filo in caso di aggancio sul fondo.

Tool designed to easily tighten the knot on the hooks, swivels or loops. Its ergonomic shape allows to apply a considerable force. Made of a very resistant plastic material of 9 mm thickness. It's suitable for both braided and large diameter nylon monofilaments. Also useful for retrieving the line in case of snagged hooks.

Outil conçu pour serrer facilement le nœud de l'hameçon, de l'émerillon ou de la boucle. Sa forme ergonomique permet d'exercer une force considérable. Fabriqué en matériau plastique très résistant de 9 mm d'épaisseur. Il convient aussi bien aux lignes tressées qu'aux monofilaments en nylon de grand diamètre. Utile également pour récupérer la ligne en cas d'accrochage au fond.

BUSTA DA 1 PEZZO - CONFEZIONE DA 5 BUSTE
1 PIECE PER BAG - PACK SIZE 5 BAGS

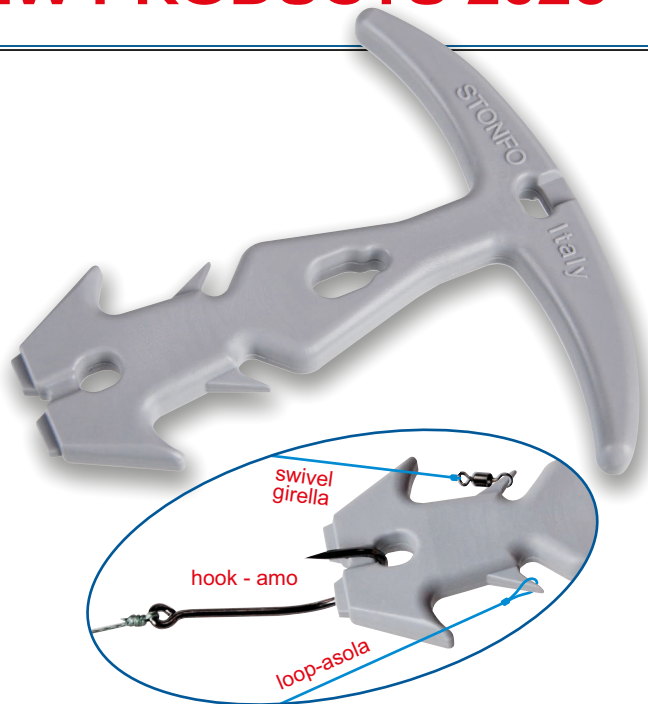

Art.589-1 NOSE RING MAXI

Anelli in acciaio inox versione Maxi per l'innescare facile e rapido del pesce vivo. Questo modello più robusto è indicato per ami di grandi dimensioni ed esche adeguate. L'anello viene avvitato direttamente sull'amo e poi bloccato definitivamente con una goccia di cianoacrilica. La misura piccola è indicata per ami da 6/0 a 8/0 mentre la grande da 9/0 a 12/0.

Stainless steel rings type MAXI for easy and fast baiting of live fish. This sturdier model is suitable for large hooks and baits. The ring has to be screwed on the hook, then fixed with a drop of cyanoacrylate glue. The small size is suitable for hooks from 6/0 to 8/0 while the large for hooks from 9/0 to 12/0.

Bagues en acier inox version MAXI pour accrocher rapidement et facilement un vif. Ce modèle plus robuste est conçu pour les gros hameçons et vifs. La bague est vissée directement sur l'hameçon et bloquée définitivement avec une goutte de colle cyanoacrylate. La petite taille convient aux hameçons de 6/0 à 8/0 tandis que la grande aux hameçons de 9/0 à 12/0.

BUSTA DA 6 PEZZI - CONF. DA 10 BUSTE
6 PIECES PER BAG - PACK SIZE 10 BAGS

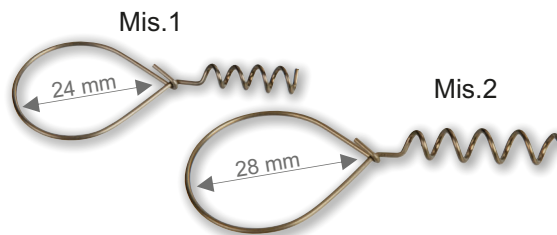

Art.765 TATAKI SNAP



Moschettoni in acciaio inox ideali per la pesca a tatakì. La loro forma arrotondata permette la massima libertà di movimento all'esca artificiale. Forniti completi di girella.

Stainless steel snaps ideal for tatakì fishing. Their rounded shape allows greater freedom of movement to the lures. Supplied complete with swivels.

Agrafes en acier inox idéales pour la pêche au tatakì. Leur forme arrondie permet une complète liberté de mouvement des leurres. Livrés avec émerillons.

BUSTA DA 6 PZ. - CONF. DA 10 BU. * 6 PCS PER BAG - PACK SIZE 10 BAGS

GUARANTEED STRENGTH

Dim.mm	Wire	Weight	Strength
13x6	Ø 0,6	gr 0,08	kg 10





NEW PRODUCTS 2026

Art.768 GUARDIAN CLIP

Gancetto in acciaio inox studiato per lo sgancio rapido del piombo guardiano. L'appendice in gomma rossa lo rende ben visibile e ne facilita la presa. Munito di girella integrata.

Stainless steel clip designed for quick release of the guardian lead. The red rubber grip makes it highly visible and easy to take. Equipped with an integrated swivel.

Agrafe en acier inox conçu pour décrocher rapidement le plomb gardien. La poignée en caoutchouc rouge assure une visibilité optimale et une prise facile. Émerillon intégré.

BUSTA DA 2 PZ. - CONFEZIONE DA 5 BUSTE
2 PIECES PER BAG - PACK SIZE 5 BAGS

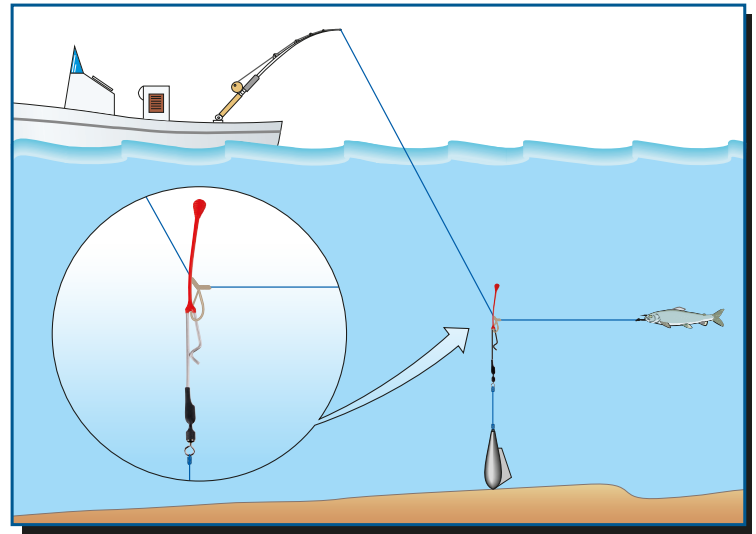

Art.762 SPOOL BANDS

Elastici piatti per bobine, studiati per tenere il filo in ordine e pronto all'uso. Muniti di boccola in materiale autolubrificante che garantisce un perfetto scorrimento del filo. La speciale linguetta agevola sia l'avvolgimento che l'estrazione del filo. Disponibili in due misure.

Flat elastic bands for spools, designed to keep line organized and ready to use. Equipped with a self-lubricating bushing which ensures perfect line sliding. The special tab facilitates both the winding and the extraction of the line. Available in two sizes.

Bandes élastiques plates pour bobines, conçues pour maintenir le fil organisé et prêt à l'emploi. Dotées d'une bague autolubrifiante pour assurer un guidage parfait du fil. La languette spéciale facilite l'enroulement et l'extraction du fil. Disponibles en deux tailles.

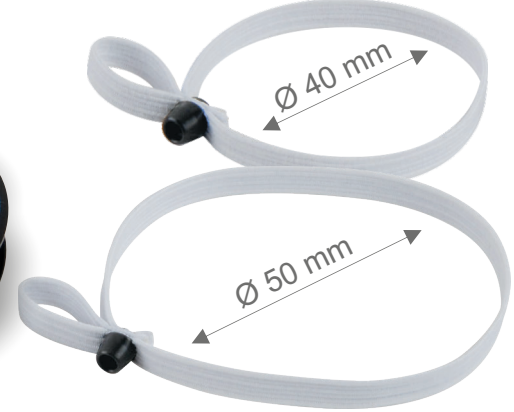

Size 1	Ø 40 mm	height 5 mm
Size 2	Ø 50 mm	height 5 mm

BUSTA DA 5 PEZZI - CONFEZIONE DA 5 BUSTE * 5 PIECES PER BAG - PACK SIZE 5 BAGS

Art.759 MICRO PLIER MICRO PINZA - MICRO PINCE

Pinza studiata per schiacciare l'ardiglione di ami di misura medio piccola senza forzare e danneggiare l'amo. Grazie alle sue ganasce in acciaio temprato piatte e sottili questa pinza risulta ideale anche nella slamatura. Impugnatura anatomica. Dimensioni ridotte, lunghezza cm 10. Leggerissima solo gr 36.

Plier designed to crush the barb of medium and small hooks without forcing or damaging the hooks. Thanks to its flat and thin hardened steel jaws, this plier are also excellent for removing hook from fish. Anatomic handle. Ultra compact design, length cm 10. Ultra lightweight 36 grams only.

Pince conçue pour écraser l'ardillon des hameçons de taille moyenne et petite sans forcer et endommager l'hameçon. Grâce à ses becs en acier trempé plats et fins, cette pince est également idéale pour décrocher vos hameçons dans la gueule du poisson. Poignée anatomique. Très petite, longueur cm 10. Très légère seulement gr 36.

BUSTA DA 1 PZ. - CONF. DA 5 BU. * 1 PIECE PER BAG - PACK SIZE 5 BAGS

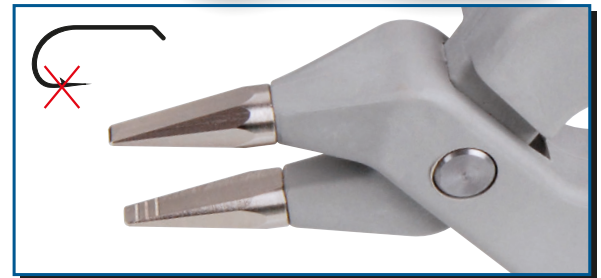

Art.767 LEAD CLIP MINI

Mini clips di attacco per piombo complete di conetti in gomma e girelle.

Mini Lead Clips including coniform rubber tails and swivels.

Mini Clips pour plomb munies de caoutchouc conique et d'émerillons.

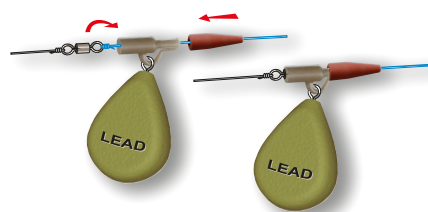

BUSTA DA 10 PEZZI - CONFEZIONE DA 10 BUSTE * 10 PIECES PER BAG - PACK SIZE 10 BAGS



NEW PRODUCTS 2026

Art.761 GHOST BAIT BANDS



Anellini sottili in puro silicone ideali per l'innesco di pellets. Grazie alla loro dimensione ridotta ed al colore neutro l'innesco risulterà più attrattivo. Garantiscono un'ottima tenuta sul pellet ed un'eccezionale resistenza alla rottura. Disponibile in 3 misure per pellets da 3 a 12 mm. Per la dimensione e la consistenza del materiale raccomandiamo di utilizzare l'inseritore Bait bander tool art.697.



Thin bands in pure silicone ideal for pellets. Thanks to their small dimensions and natural color the bait will be more attractive. They guarantee an excellent grip on the pellet and exceptional breaking strength. Supplied in 3 sizes from 3 to 12 mm pellets. Due to the small dimensions and consistency of the material we recommend the use of Bait bander tool code 697.



Bagues fines en pur silicone idéales pour les pellets. Grâce à leur petite taille et leur couleur neutre, l'appât sera plus attractif. Elles garantissent une excellente tenue du pellet et une résistance exceptionnelle à la rupture. Disponibles en 3 tailles pour pellets de 3 à 12 mm. En raison de la taille et de la consistance du matériau, nous recommandons d'utiliser l'outil d'insertion Bait bander tool art.697.

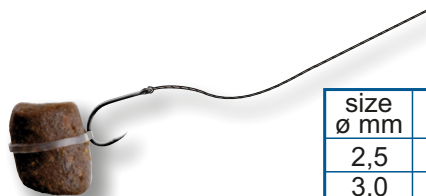

size ø mm	pellet ø min ø max	
2,5	3	6 mm
3,0	6	8 mm
4,0	8	12 mm



BUSTA DA 100 PEZZI - CONFEZIONE DA 10 BUSTE
100 PIECES PER BAG - PACK SIZE 10 BAGS

Art.766 WINDER CONNECTOR



Connettore lenza-elastico resistente e leggerissimo, permette la regolazione della lunghezza della lenza. Le sue dimensioni sono molto ridotte e la sua forma simmetrica è perfettamente in linea con la lenza e l'elastico. Durante la pesca, se la profondità cambia è possibile avvolgere o svolgere il filo dal connettore per avere sempre la distanza desiderata tra la punta della canna ed il galleggiante. Questo eviterà di dover tagliare o aggiungere spezzoni di lenza. Capacità di avvolgimento circa 3 metri. Prodotto in due diverse misure per elastici fino a 2,8 mm di diametro.



Durable and lightweight line-elastic connector that allows to adjust the length of the line. Its dimensions are very small and its symmetrical shape is perfectly aligned with the line and elastic. While fishing, if the depth changes, you can wind or unwind the line from the connector to always have the desired distance between pole tip and float. In this way there's no need to cut or add bits of line. Winding capacity approximately 3 meters. Produced in two different sizes for elastics up to 2.8 mm in diameter.



Connecteur de ligne-élastique résistant et léger, permet d'ajuster la longueur de la ligne. Sa taille compacte et sa forme symétrique s'alignent parfaitement avec la ligne et l'élastique. Pendant la pêche, si la profondeur change, il est possible enrouler ou dérouler la ligne autour du connecteur afin de toujours conserver la distance souhaitée entre le scion et le flotteur. Plus besoin de couper ou d'ajouter de morceaux de ligne. Capacité d'enroulement environ 3 mètres. Disponible en deux tailles pour élastiques jusqu'à 2,8 mm de diamètre.

Size	Ø Elastic	winding capacity
1	1,6 max	2,5 mt Ø 0,14
2	2,8 max	3,0 mt Ø 0,18

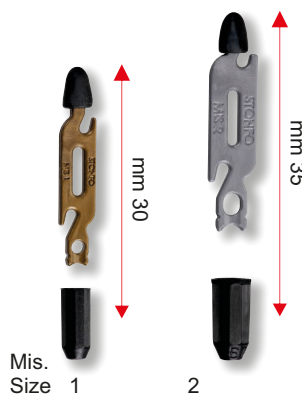

BUSTA DA 2 PEZZI - CONFEZIONE DA 10 BUSTE
2 PIECES PER BAG - PACK SIZE 10 BAGS

Art.291-4 BICCHIERINO RETICOLARE PASTURA TIPO B

GROUND BAIT MESH POUCH TYPE B FOR CATAPULTS
GODET RÉTICULÉ POUR FRONDES AMORCE TYPE B



Bicchierino per fionde prodotto in gomma morbida di alta qualità. Ideale per il lancio di palle di pastura.



Pouch for catapults made of high-quality soft rubber. Ideal for launching groundbait balls.





Godet pour frondes en caoutchouc souple de haute qualité. Idéal pour lancer des boules d'amorce.



BUSTA DA 1 PEZZO - CONFEZIONE DA 10 BUSTE
1 PIECE PER BAG - PACK SIZE 10 BAGS

Art.748 PRECISION PLUMMETS SONDE PRECISION - SONDES PRÉCISION

 Sonde con passaggio diretto e centrale del filo, consentono una precisa misurazione del fondo. L'amo dovrà essere introdotto nell'asola superiore e seguendo il taglio laterale andrà poi fissato alla gomma posta alla base. Il filo e l'amo si troveranno così ben centrati e protetti all'interno della sonda. L'asola superiore in plastica non danneggia il filo. La forma a base ampia rende più facile la percezione del fondale. Realizzate con materiale atossico. Disponibili nei pesi 8-13-20-30 gr.

 Plummets with central and direct line passage, they allow an accurate depth reading. The hook must be inserted inside the upper loop and following the side groove must then be fixed to the rubber at the base of the plummet. The line and the hook will thus be well centered and protected inside the plummet. The plastic loop, does not damage the line. The shape with a wide base makes the perception of the bottom easier. Made of non-toxic material. Available in the weights of 8-13-20-30 gr.

 Sondes avec passage du fil direct et central, permettent une mesure précise du fond. L'hameçon est d'abord introduit dans la boucle supérieure et en suivant la coupe latérale il sera ensuite fixé au caoutchouc placé à la base. Le fil et l'hameçon seront ainsi bien centrés et protégés à l'intérieur de la sonde. La boucle en plastique, n'abîme pas le fil. La forme à base large facilite la perception du fond. Fabriquées avec un matériau non toxique. Disponibles en poids 8-13-20-30 gr.

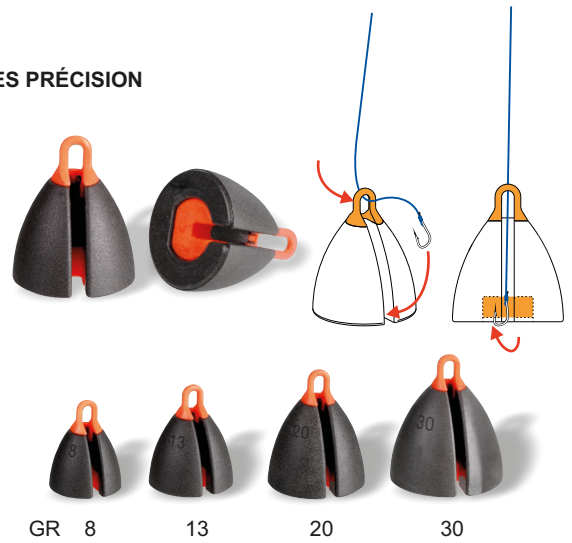

BUSTA DA 2 PZ. - CONF. DA 5 BU.
2 PIECES PER BAG - PACK SIZE 5 BAGS

Art.758 MICRO SHOT PLIER PINZA PER PALLINI, STYL, STOTZ - PINCE À PLOMBS, STYL, STOTZ

 Pinza studiata per applicare agevolmente sul filo pallini in piombo, anche piccolissimi, oltre a Styl e Stotz di tutte le misure. Le ganasce in acciaio temprato sono appositamente sagomate da permettere la rimozione del piombo senza danneggiare il filo. Impugnatura anatomica.

 Plier designed to apply shots, even very small ones, in addition to Styl and Stotz on the line easily. The hardened steel jaws are specially shaped to allow the lead to be removed without damaging the line. Anatomic handle.

 Pince conçue pour placer facilement les plombs, même les plus petits, ainsi que des Styl et Stotz de toutes tailles. Les mâchoires en acier trempé sont spécialement formées pour permettre d'enlever les plombs sans abîmer le fil. Poignée anatomique.

BUSTA DA 1 PZ. - CONF. DA 5 BU. * 1 PIECE PER BAG - PACK SIZE 5 BAGS



Art.749 CATALINA NEEDLE AGO PER INNESCO CATALINA - AIGUILLE À VIF CATALINA

 Ago in acciaio inox per l'innesco Catalina. La sua punta a forma di gancio, ottenuta con lavorazione dal pieno con macchinari ad alta precisione, è stata appositamente studiata per agevolare l'inserimento dell'elastico senza arrecare danni al pesce. Fornito completo di elastici e copri-punta.

 Stainless steel needle for Catalina baiting. Its hook-shaped tip, obtained by machining from solid with high-precision machinery, has been specifically designed to facilitate the insertion of the elastic without causing damage to the fish. Supplied complete with elastic bands and tip cover.

 Aiguille en acier inox pour accroche Catalina. Sa pointe en forme de crochet, obtenue par usinage du solide avec des machines de haute précision, a été spécialement conçue pour faciliter l'insertion de l'élastique sans endommager le poisson. Livré complet avec élastiques et couvre-pointe.

BUSTA DA 1 PZ. - CONF. DA 5 BU. * 1 PIECE PER BAG - PACK SIZE 5 BAGS

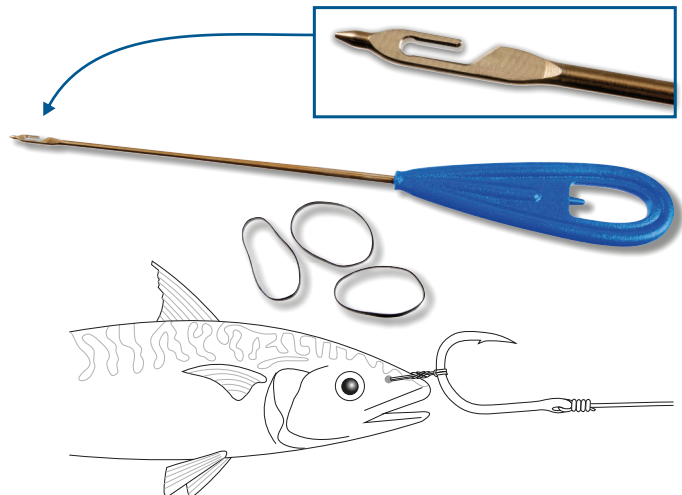

Art.747 MICRO SPLIT RING PLIER PINZA PER SPLIT RINGS PICCOLI - PINCE À ANNEAUX BRISÉS PETITS

 Pinza appositamente studiata per inserire o togliere gli split rings più piccoli. Munita di punte in acciaio temprato ed impugnatura anatomica. Piccolissima Lunghezza cm 10. Leggerissima solo gr 36.

 Plier designed to insert or remove micro split rings. Equipped with hardened steel tips and anatomic handle. Ultra compact design Length cm 10. Ultra lightweight 36 grams only.

 Pince conçue pour insérer ou retirer les anneaux brisés les plus petits. Équipée de mors en acier trempé et poignée anatomique. Très petite Longueur cm 10. Très légère seulement gr 36.





BUSTA DA 1 PZ. - CONF. DA 5 BU.
1 PIECE PER BAG - PACK SIZE 5 BAGS

BOX + WINDERS

SCATOLA + AVVOLGILENZA * BOITE + PLIOIRS

 Scatole in materiale plastico antiurto contenenti varie misure di avvolgilenza Stonfo. Fornite di gancetti estrattori. Dimensioni delle scatole 26x19x2,6 cm.

 Shockproof plastic boxes with various sizes of Stonfo winders inside. Supplied with winder extractors. Dimensions of the box 26x19x2,6 cm.

 Boîtes en plastique antichoc contenant différentes mesures de plioirs Stonfo. Équipés de crochets d'extraction. Dimensions de la boîte 26x19x2,6 cm.

Art.733

BOX + WINDERS 18x1,2 CM MINI
SCATOLA + AVVOLGILENZA CM 18 MINI
BOITE + PLIOIRS CM 18 EXTRA ÉTROITES

CONT. PCS. 21



Art.734

BOX + WINDERS 18x1,6 CM NARROW
SCATOLA + AVVOLGILENZA CM 18 STRETTE
BOITE + PLIOIRS CM 18 ÉTROITES

CONT. PCS. 15

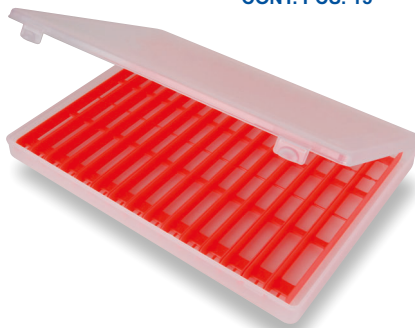

Art.735

BOX + WINDERS 18x2,0 CM WIDE
SCATOLA + AVVOLGILENZA CM 18 LARGHE
BOITE + PLIOIRS CM 18 LARGES

CONT. PCS. 13



Art.751

BOX + WINDERS 20x1,3 + 18x1,2 CM MINI
SCATOLA + AVVOLGILENZA MINI
BOITE + PLIOIRS EXTRA ÉTROITES

CONT. PCS. 14+4

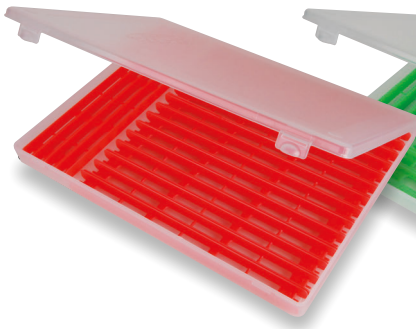

Art.752

BOX + WINDERS 20x1,6 + 18x1,6 CM NARROW
SCATOLA + AVVOLGILENZA STRETTE
BOITE + PLIOIRS ÉTROITES

CONT. PCS. 11+3

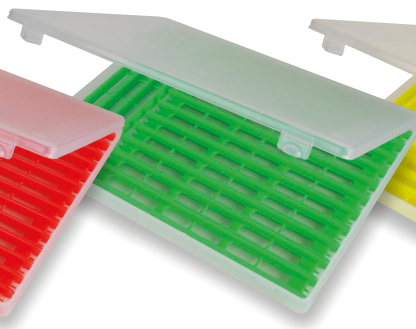

Art.753

BOX + WINDERS 22x1,4 + 18x1,2 CM MINI
SCATOLA + AVVOLGILENZA MINI
BOITE + PLIOIRS EXTRA ÉTROITES

CONT. PCS. 13+3

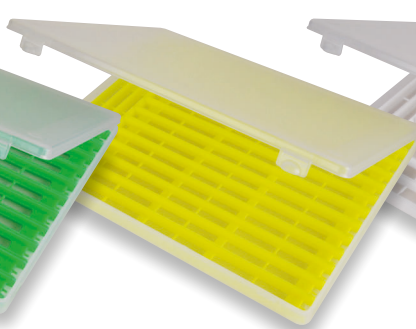

Art.754

BOX + WINDERS 22x1,8 + 18x1,6 CM NARROW
SCATOLA + AVVOLGILENZA STRETTE
BOITE + PLIOIRS ÉTROITES

CONT. PCS. 10+2

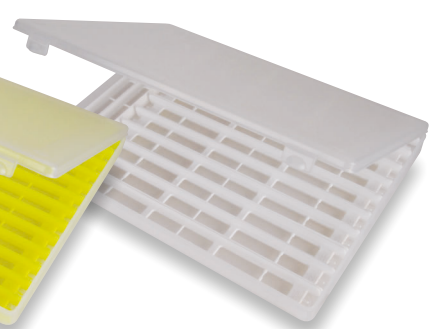

Art.739

BOX + WINDERS 25x1,4 CM MINI
SCATOLA + AVVOLGILENZA CM 25 MINI
BOITE + PLIOIRS CM 25 EXTRA ÉTROITES

CONT. PCS. 13

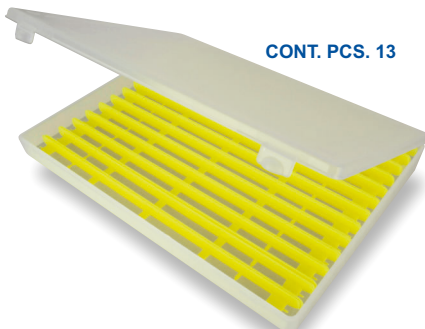

Art.736

BOX + WINDERS 25x1,8 CM NARROW
SCATOLA + AVVOLGILENZA CM 25 STRETTE
BOITE + PLIOIRS CM 25 ÉTROITES

CONT. PCS. 10

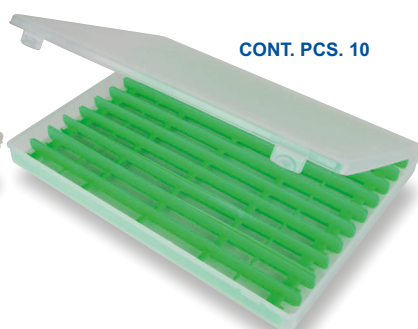

Art.737

BOX + WINDERS 25x2,5 CM WIDE
SCATOLA + AVVOLGILENZA CM 25 LARGHE
BOITE + PLIOIRS CM 25 LARGES

CONT. PCS. 7

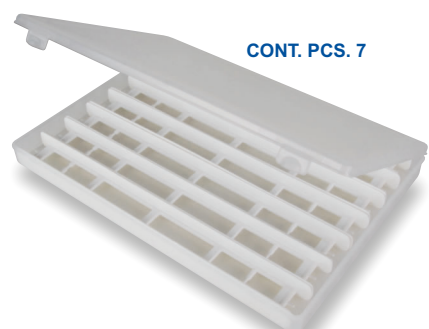





NEW PRODUCTS 2025

Art.755 POLE WINDER LABELS 79x8 mm ETICHETTE ADESIVE PER AVVOLGILENZA - AUTOCOLLANTS POUR PLOIIRS

 Etichette adesive in materiale plastico adatte per essere applicate su avvolgilenza. L'etichetta permette di scrivere i vari dettagli di ciascuna lenza sull'avvolgilenza in modo da sapere esattamente cosa contiene. Caratteristiche delle etichette: resistenti all'acqua ed all'usura, adesivo permanente, retrotagli per una facile applicazione, permettono la scrittura anche con una normale penna.

 Adhesive labels in plastic material suitable for the application on winders. The label allows you to write the various details of each rig on the winder so you know exactly what it contains. Features of the labels: water and wear resistant, permanent adhesive, back cuts for easy application, writing even with a normal pen.

 Étiquettes adhésives en matière plastique, idéales pour être appliquées sur les ploirs. L'étiquette permet d'écrire les différents détails de chaque ligne sur le plioir afin de savoir exactement ce qu'il contient. Caractéristiques des étiquettes : résistantes à l'eau et à l'usure, adhésif permanent, découpes au dos pour une application facile, on peut aussi écrire avec un stylo normal.

BUSTA DA 30 PEZZI - CONF.DA 10 BU.* 30 PCS PER BAG - PACK SIZE 10 BAGS



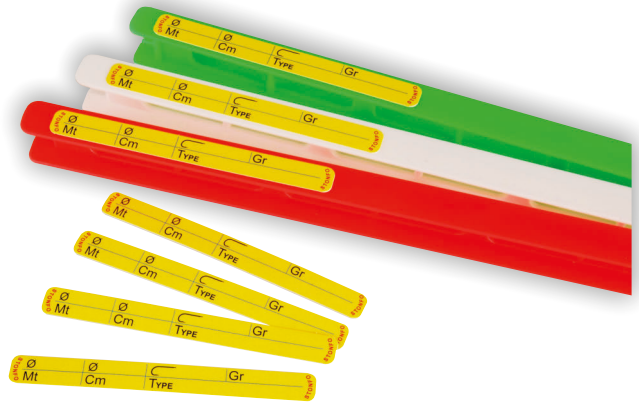

PE PLASTIC MATERIAL



Art.756 ROUND WINDER LABELS Ø 46 mm ETICHETTE ADESIVE PER AVVOLGILENZA TONDE AUTOCOLLANTS POUR PLOIRS ROND

 Etichette adesive in materiale plastico adatte per essere applicate su avvolgilenza tonde. L'etichetta permette di scrivere i vari dettagli di ciascun calamento sull'avvolgilenza in modo da sapere esattamente cosa contiene. Caratteristiche delle etichette: resistenti all'acqua ed all'usura, adesivo permanente, retrotagli per una facile applicazione, permettono la scrittura anche con una normale penna.

 Adhesive labels in plastic material suitable for the application on Eva winders and round winders. The label allows you to write the various details of each rig on the winder so you know exactly what it contains. Features of the labels: water and wear resistant, permanent adhesive, back cuts for easy application, writing even with a normal pen.

 Étiquettes adhésives en matière plastique, idéales pour être appliquées sur les ploirs ronds. L'étiquette permet d'écrire les différents détails de chaque montage sur le plioir afin de savoir exactement ce qu'il contient. Caractéristiques des étiquettes : résistantes à l'eau et à l'usure, adhésif permanent, découpes au dos pour une application facile, on peut aussi écrire avec un stylo normal.

BUSTA DA 30 PEZZI - CONF.DA 10 BU.* 30 PCS PER BAG - PACK SIZE 10 BAGS

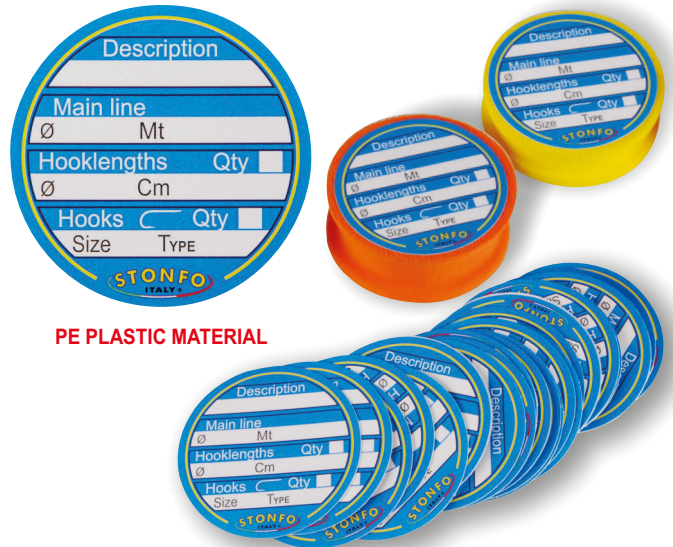

PE PLASTIC MATERIAL

Art.757 ROUND WINDER LABELS Ø 58 mm ETICHETTE ADESIVE PER AVVOLGILENZA TONDE AUTOCOLLANTS POUR PLOIRS ROND

 Etichette adesive in materiale plastico adatte per essere applicate su avvolgilenza tonde. L'etichetta permette di scrivere i vari dettagli di ciascun calamento sull'avvolgilenza in modo da sapere esattamente cosa contiene. Caratteristiche delle etichette: resistenti all'acqua ed all'usura, adesivo permanente, retrotagli per una facile applicazione, permettono la scrittura anche con una normale penna.

 Adhesive labels in plastic material suitable for the application on Eva winders and round winders. The label allows you to write the various details of each rig on the winder so you know exactly what it contains. Features of the labels: water and wear resistant, permanent adhesive, back cuts for easy application, writing even with a normal pen.

 Étiquettes adhésives en matière plastique, idéales pour être appliquées sur les ploirs ronds. L'étiquette permet d'écrire les différents détails de chaque montage sur le plioir afin de savoir exactement ce qu'il contient. Caractéristiques des étiquettes : résistantes à l'eau et à l'usure, adhésif permanent, découpes au dos pour une application facile, on peut aussi écrire avec un stylo normal.

BUSTA DA 30 PEZZI - CONF.DA 10 BU.* 30 PCS PER BAG - PACK SIZE 10 BAGS



PE PLASTIC MATERIAL

APICALE STONFO

DISPOSITIVO PER L'AGGANCIAMENTO RAPIDO DELLA LENZA ALLA CANNA DA PESCA
STONFO LINE CONNECTOR - FIXE-LIGNE

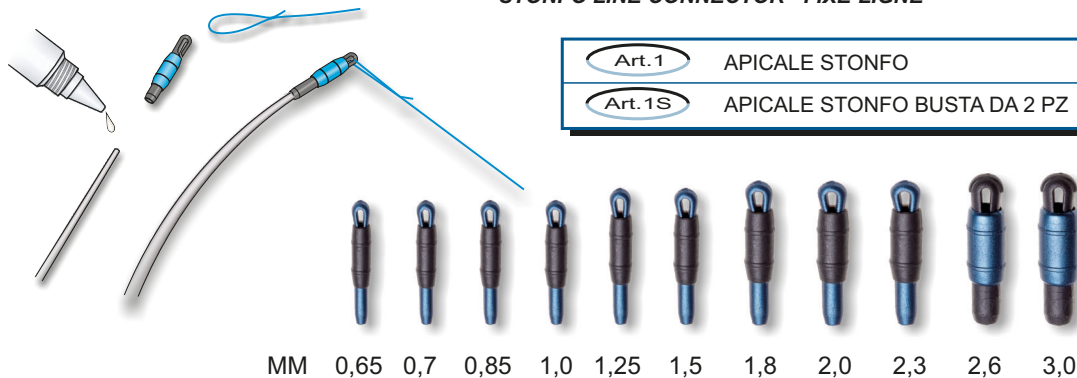

Art.1	APICALE STONFO
Art.1S	APICALE STONFO BUSTA DA 2 PZ



L'apicale Stonfo è un dispositivo per il fissaggio rapido della lenza alla canna da pesca, di facile applicazione, leggero, è prodotto in varie misure per essere montato su ogni tipo di canna. Il suo uso permette di risparmiare tempo prezioso, infatti è sufficiente fare una semplice asola alla lenza per avere un bloccaggio rapido e sicuro. Per l'applicazione dell'apicale al cimino della canna è consigliabile l'uso di un collante cianacrilico.



The connector Stonfo is a device for attaching the line to the tip, easy to handle, very light and available in various sizes for any type of rods. To fix the apicale on the tip we recommend the use of a cyanacrylic glue.



Fixe ligne Stonfo, dispositif de fixation de la ligne à la canne, très léger d'une adaptation extrêmement simple. Disponible en différentes mesures, il s'adapte à tous les types de canne. Il est pratique et étudié pour épargner du temps. Pour fixer la première fois l'apicale sur le scion nous conseillons la colle de type cyanacrilique.

APICALE ELITE

LEGERISSIMO E DI DIMENSIONI RIDOTTE PER IL FISSAGGIO DELLA LENZA ALLA CANNA
"ELITE" LINE CONNECTORS - FIXE LIGNE ELITE CARBONE, ULTRA LEGERES, PLUS PETITS

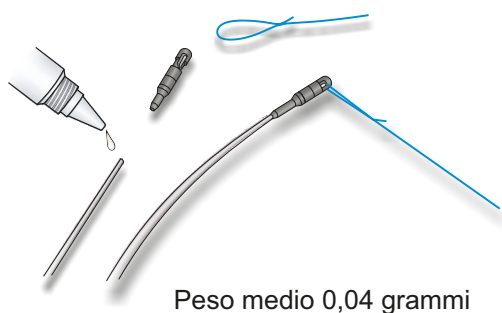

Peso medio 0,04 grammi

Art.232	APICALE ELITE
Art.232S	APICALE ELITE BLISTER DA 2 PZ



L'Apicale Elite è prodotto in 8 differenti misure e si può applicare, con colla cianacrilica, ad ogni cimino in vetro o carbonio. Le sue dimensioni sono notevolmente ridotte e così anche il suo peso che è di circa 0,04 grammi. Queste caratteristiche sono state raggiunte grazie anche all'impiego di un materiale che garantisce una elevata resistenza. La sua forma è esente da qualsiasi angolo netto o spigolatura.



The line-connector Elite is made in 8 different sizes and can be easily applied on glass or carbon tips. It has small dimensions and its weight is only of grammes 0,04. These features have been obtained without reducing its resistance thanks to its special material. Its shape has no sharp edges.



Fixe-ligne Elite carbone. Nouveaux fixe-ligne ultra léger 0,04 gr. environ, pour scions pleins et creux, se colle en pointe du scion, permet de changer instantanément la ligne Existe en 8 différentes mesures.

Art.724

DACRON CONNECTORS KIT



Il Dacron Connector permette una rapida connessione tra lenza ed elastico sia pieno che tubolare. Il kit comprende gommini e dacron per realizzare 6 Dacron Connectors. Ottimo anche come blocca elastico con il Pffe Curved.

Disponibile in 4 diverse misure:

- Mis. 1 verde fluo per elastici max 1,4 mm
- Mis. 2 arancio fluo per elastici max 2,0 mm
- Mis. 3 giallo fluo per elastici max 3,0 mm
- Mis. 4 blu per elastici max 4,0 mm



The Dacron Connector allows a quick connection between the line and the elastic both solid and hollow. The kit includes rubber connectors and dacron to realize 6 Dacron Connectors. Also excellent as elastic stopper with the Pffe Curved. Available in 4 different sizes:

- Size 1 green fluo for elastics max 1,4 mm
- Size 2 orange fluo for elastics max 2,0 mm
- Size 3 yellow fluo for elastics max 3,0 mm
- Size 4 blue for elastics max 4,0 mm



Le Dacron Connector permet une connexion rapide entre la ligne et l'élastique qu'il soit plein ou tubulaire. Le kit comprend des connecteurs en caoutchouc et le dacron pour réaliser 6 Dacron Connectors. Aussi excellent comme bloque élastique avec le Pffe Curved. Disponible en 4 tailles différentes:

- Taille 1 vert fluo pour élastiques max 1,4 mm
- Taille 2 orange fluo pour élastiques max 2,0 mm
- Taille 3 jaune fluo pour élastiques max 3,0 mm
- Taille 4 bleu pour élastiques max 4,0 mm

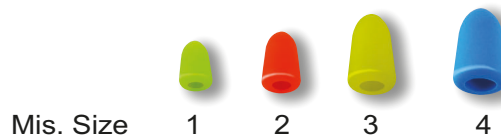

Mis. Size

1

2

3

4

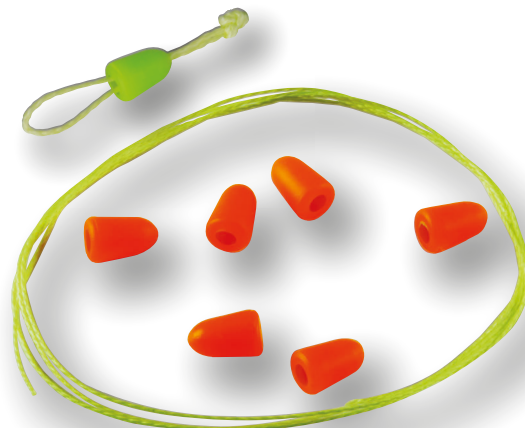

BUSTA DA 6 PEZZI + DACRON 60 CM - CONF. DA 10 BUSTE
6 PIECES + DACRON 60 CM PER BAG - PACK SIZE 10 BAGS

Art.292

APICALE SUPER ZERO

IL PIU' PICCOLO CONNETTORE PER ELASTICO
SUPER ZERO ELASTIC CONNECTOR
LE PLUS PETIT FIXE LIGNE-ÉLASTIQUE

weight 0,02 grammi

BICOLORE - BICOLOUR
BLU - BLUE
ARANCIO - ORANGE
GIALLO - YELLOW
VERDE - GREEN
ROSA - PINK
VIOLA - PURPLE
BIANCO - WHITE



per elastico 1 mm max
for elastic 1 mm max

BLISTER DA 1 PEZZO - CONFEZIONE DA 20 PEZZI
1 PER PACKET - PACK SIZE 20 PACKETS

Art.2

APICALE SUPER STONFO

MISURA STANDARD - STANDARD SIZE

PER L'AGGANCIAMENTO RAPIDO DELLA LENZA ALL'ELASTICO
SUPER STONFO ELASTIC CONNECTOR
FIXE LIGNE-ÉLASTIQUE



NERO-BLACK
BLU - BLUE
ARANCIO - ORANGE
GIALLO - YELLOW
VERDE - GREEN
ROSA - PINK
VIOLA - PURPLE
BIANCO - WHITE

CONFEZIONATI IN BUSTE DA 20 PEZZI
PACK SIZE 20 PIECES

Art.2-1

APICALE SUPER ELITE

SUPER ELITE ELASTIC CONNECTOR

PER ELASTICO DA 1,2 MM MAX
CONNECTOR FOR ELASTIC 1,2 MAX
FIXE LIGNE POUR ÉLASTIQUE 1,2 MAX



BLU - BLUE
ARANCIO - ORANGE
GIALLO - YELLOW
VERDE - GREEN
ROSA - PINK
VIOLA - PURPLE
BIANCO - WHITE

BLISTER DA 1 PEZZO - CONFEZIONE DA 20 PEZZI
1 PER PACKET - PACK SIZE 20 PACKETS

Art.2-2

APICALE SUPER MAXI

SUPER MAXI ELASTIC CONNECTOR

PER ELASTICO DA 1,9 MM MAX
CONNECTOR FOR ELASTIC 1,9 MAX
FIXE LIGNE POUR ÉLASTIQUE 1,9 MAX



BLU - BLUE
ARANCIO - ORANGE
ROSSO - RED
GIALLO - YELLOW
VERDE - GREEN
ROSA - PINK
VIOLA - PURPLE
BIANCO-WHITE



BICOLOUR
BLU - BLUE
ARANCIO-ORANGE
ROSSO - RED
GIALLO - YELLOW
VERDE - GREEN
ROSA - PINK
VIOLA - PURPLE
BIANCO-WHITE

BLISTER DA 1 PEZZO - CONFEZIONE DA 20 PEZZI * 1 PER PACKET - PACK SIZE 20 PACKETS

Art.309

APICALE SUPERONE

SUPERONE ELASTIC CONNECTOR

PER ELASTICO DA 2,5 MM MAX
CONNECTOR FOR ELASTIC 2,5 MAX
FIXE LIGNE POUR ÉLASTIQUE 2,5 MAX



BICOLOUR
BLU - BLUE
ARANCIO-ORANGE
ROSSO - RED
GIALLO - YELLOW
VERDE - GREEN
ROSA - PINK
VIOLA - PURPLE
BIANCO-WHITE

BLISTER DA 1 PEZZO - CONFEZIONE DA 20 PEZZI * 1 PER PACKET - PACK SIZE 20 PACKETS

Art.187

APICALE OVER SIZE OVER SIZE ELASTIC CONNECTOR

PER ELASTICO DA 3,1 MM MAX
CONNECTOR FOR ELASTIC 3,1 MAX - FIXE LIGNE POUR ÉLASTIQUE 3,1 MAX



Nuovo apicale per elastico studiato per l'utilizzazione di elastici di grosso diametro (Ø 3,1 mm) e grande resistenza.



New elastic connector for big (Ø 3,1 mm) and strong elastics.



Nouveau fixe-ligne pour les gros diamètres d'élastique jusqu'à Ø 3,1 mm.

COLORI - COLOURS:
ARANCIO - ORANGE
ROSSO - RED
GIALLO - YELLOW
VERDE - GREEN
BIANCO-WHITE
BLU-BLUE



BLISTER DA 1 PEZZO - CONFEZIONE DA 20 PEZZI
1 PER PACKET - PACK SIZE 20 PACKETS

Art.687

APICALE SOFTLINK PER ELASTICO DA 4 MM MAX

SOFTLINK ELASTIC CONNECTOR FOR ELASTIC 4 MM MAX



Il sistema più rapido e sicuro di collegamento tra filo ed elastico. L'Apicale Softlink è costituito da un corpo estremamente resistente con coprinodo ammortizzante in gomma, è ideale per elastici pieni o tubolari fino a 4 mm di diametro.



The quickest and safest device to connect line and elastic. The Softlink elastic connector is composed of an highly resistant body with rubber knot cover. It is ideal for solid or hollow elastics up to 4 mm of diameter.



Le système le plus rapide et sûr pour connecter la ligne à l'élastique. Le connecteur Softlink composé d'un corps très résistant avec couvre-nœud amortissant en caoutchouc, est idéal pour élastiques creux ou pleins jusqu'à 4 mm de diamètre.

COLORI - COLOURS:
ARANCIO - ORANGE
GIALLO - YELLOW
VERDE - GREEN

coprinodo in gomma
rubber knot cover



BUSTA DA 1 PEZZO - CONFEZIONE DA 20 BUSTE
1 PER BAG - PACK SIZE 20 BAGS

Art.3-0 TUBOLARI IN PTFE

PTFE TIP BUSHES - POINTES EN PTFE POUR SCIONS CREUX



Tubolari torniti in PTFE per vette con elastico.



Machined self-lubricating ptfе bushes for tips with elastic.



Pointes tournées en ptfе autolubrifiant pour scions à élastique.

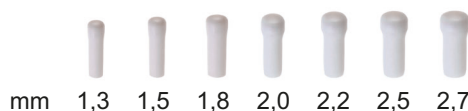

mm 1,3 1,5 1,8 2,0 2,2 2,5 2,7

CONFEZIONATI IN BUSTE DA 20 PEZZI - PACK SIZE 20 PIECES

Art.3-00 TUBOLARI IN PTFE MAXI

BIG BORE PTFE TIP BUSHES - POINTES EN PTFE AVEC GROS TROU



Tubolari torniti in PTFE con foro grande per l'utilizzo di elastici di grande diametro.



Special sizes for big elastic.



Idéales pour élastiques à grand diamètre.



mm 2,2 2,5 2,7 3,0 3,2 3,5 4,0 4,5 5,0

CONFEZIONATI IN BUSTE DA 20 PEZZI - PACK SIZE 20 PIECES

Art.368 TUBOLARI IN PTFE PER INTERNO

INTERNAL PTFE TIP BUSHES
POINTE PTFE INTÉRIEURE POUR ÉLASTIQUE



Tubolari torniti in PTFE per vette con elastico. Si adattano all'interno del vettino o sottovetta.



Machined internal fitting self-lubricating ptfе bushes for tips with elastic.



Pointes tournées en ptfе intérieure autolubrifiant pour scions à élastique.



Ø FORO
BORE mm 1,1 1,4 1,7 2,0 2,3 2,6 2,8 3,1 3,3 3,4 3,5

CONFEZIONATI IN BUSTE DA 20 PEZZI - PACK SIZE 20 PIECES

TUBOLARI IN PTFE busta 2 pezzi

PTFE TIP BUSHES - POINTES EN PTFE POUR SCIONS CREUX



Tubolari torniti in PTFE per vette con elastico.



Machined self-lubricating ptfе bushes for tips with elastic.



Pointes tournées en ptfе autolubrifiant pour scions à élastique.



Art.3-0S	TUBOLARI PTFE	Ø mm 1,3- 1,5- 1,8- 2,0- 2,2- 2,5- 2,7
Art.3-00S	TUBOLARI PTFE MAXI	Ø mm 2,2- 2,5- 2,7- 3,0- 3,2- 3,5- 4,0- 4,5- 5,0
Art.368S	TUBOLARI PTFE INTERNO	Ø mm 1,1-1,4-1,7-2,0-2,3-2,6-2,8-3,1-3,3-3,4-3,5

BUSTA DA 2 PZ.-CONF.DA 10 BUSTE * 2 PIECES PER BAG-PACK SIZE 10 BAGS

Art.580 TUBOLARI PTFE SMALL HOLE

SMALL HOLE PTFE BUSHES



Tubolari torniti in puro PTFE con foro piccolo per un elastico di Ø 1,3 mm max.



Machined pure PTFE bushes. Suitable for elastic of Ø mm 1,3 max.



Pointes tournées en pur PTFE avec trou petit étudiées pour élastiques de Ø 1,3 mm max.



Mis. Size
Ø mm 2,9 3,2 3,6 4,0

BUSTA DA 2 PZ.-CONF.DA 10 BUSTE
2 PIECES PER BAG-PACK SIZE 10 BAGS

Art.581 TUBOLARI PTFE 2nd SECTIONS

2ND SECTIONS PTFE BUSHES



Tubolari torniti in puro PTFE per sottovetta. Ideali per elastici di grande diametro pieni e tubolari.



Machined pure PTFE bushes for 2nd.sections. Suitable for big tubular or solid elastics.



Pointes tournées en pur PTFE pour le deuxième pièce. Étudiées pour élastiques de grand diamètre creux ou plein.

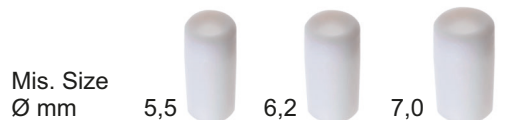

Mis. Size
Ø mm 5,5 6,2 7,0

BUSTA DA 2 PZ.-CONF.DA 10 BUSTE
2 PIECES PER BAG-PACK SIZE 10 BAGS

Art.595 TUBOLARI PTFE INTERNO FORO GRANDE

INTERNAL POLE BUSHES BIG BORE



I tubolari per elastico Stonfo sono torniti con precisione da barra in puro PTFE per una grande scorrevolezza e lunga durata dell'elastico. Versione da montare internamente nel secondo pezzo con elastici cavi di grande diametro.



Stonfo pole bushes perfectly machined from 100% pure PTFE. Fits perfectly into the 2nd section, Ideal for the biggest hollow elastic.



Pointes internes Stonfo tournées avec précision en pur ptfе pour le deuxième pièce. Idéales pour élastiques de grand diamètre creux.

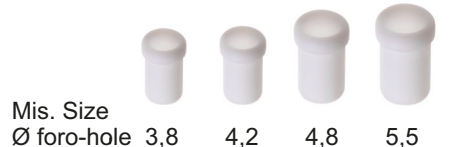

Mis. Size
Ø foro-hole 3,8 4,2 4,8 5,5

BUSTA DA 2 PEZZI - CONFEZIONE DA 10 BUSTE
2 PIECES PER BAG - PACK SIZE 10 BAGS

Art.394 TUBOLARI IN PTFE COLORATI

COLORED PTFE TIP BUSH - POINTES EN PTFE POUR ÉLASTIQUE



I tubolari per elastico in PTFE Stonfo, grazie all'alta qualità di lavorazione ed al materiale autolubrificante, garantiscono una eccezionale scorrevolezza e durata dell'elastico.



Self-lubricating ptfе tip guides for elastic tips.



Pointes en ptfе autolubrifiant pour scions à élastique.

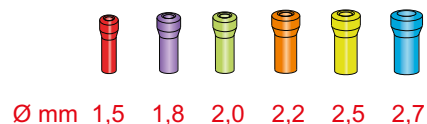

Ø mm 1,5 1,8 2,0 2,2 2,5 2,7

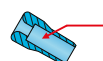

doppio diametro interno
internal double diameter
diamètre double intérieur

BUSTA DA 2 PEZZI - CONFEZIONE DA 20 BUSTE
2 PER BAG - PACK SIZE 20 BAGS

Art.5 BASI PER ELASTICO PICCOLE

SMALL SIZES BASE PLUGS
PETITES BASES A CROCHET POUR ÉLASTIQUE

CONFEZIONATI IN BUSTE DA 20 PEZZI - PACK SIZE 20 PIECES



Art.6 BASI PER ELASTICO GRANDI

BIG SIZES BASE PLUGS
GROSSES BASES A CROCHET POUR ÉLASTIQUE

CONFEZIONATI IN BUSTE DA 20 PEZZI - PACK SIZE 20 PIECES



Art.5-1 BASI REGOLABILI per elastico

ADJUSTABLE BASE PLUG - BASE RÉGLABLE

Prodotta in 4 misure per una completa adattabilità ai vari diametri di canne, consente di regolare la tensione dell'elastico.

Adjustable base plug for elastic, produced in 4 different sizes for a full adaptability. Permits to increase or decrease the elastic tension: twisting the base plug, it will expand or decrease in size.

Base réglable d'accrochage pour élastique, en 4 mesures différentes pour une complète adaptation aux différents diamètres des cannes. Permet d'ajuster la tension de l'élastique.

CONFEZIONE DA 10 PEZZI - PACK SIZE 10 PIECES

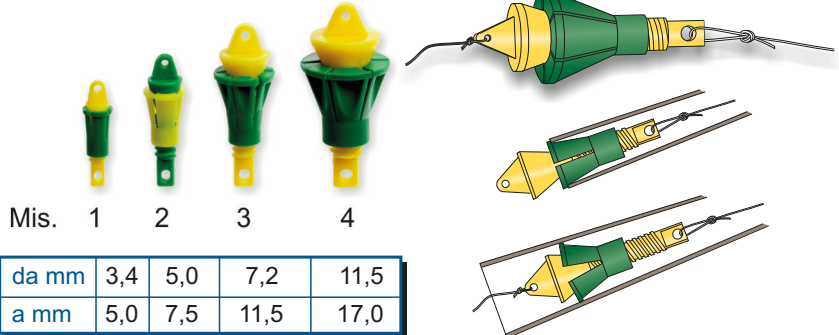

Art.5-1S BASI REGOLABILI blister da 1 pezzo

ADJUSTABLE BASE PLUG - BASE RÉGLABLE

Prodotta in 4 misure per una completa adattabilità ai vari diametri di canne, consente di regolare la tensione dell'elastico.

Adjustable base plug for elastic, produced in 4 different sizes for a full adaptability. Permits to increase or decrease the elastic tension: twisting the base plug, it will expand or decrease in size.

Base réglable d'accrochage pour élastique, en 4 mesures différentes pour une complète adaptation aux différents diamètres des cannes. Permet d'ajuster la tension de l'élastique.

BLISTER DA 1 PZ.-CONF.DA 10 PEZZI * 1 PER PACKET - PACK SIZE 10 PACKETS



Art.330 CONO REGOLABILE

ADJUSTABLE CONIC ELASTIC TENSIONER

Sistema conico di aggancio per elastico. Leggerissimo, consente la regolazione della tensione dell'elastico.

Adjustable conic elastic tensioner. Ultra light, permits to increase or decrease the elastic tension.

Embase conique d'accrochage pour élastique. Ultra légère, permet d'ajuster la tension de l'élastique.

Mis.	da mm	a mm	peso gr
1	5,6	12	0,7
2	12	19	1,4
3	19	26	1,9



BUSTA DA 1 PEZZO - CONF.DA 10 BUSTE * 1 PIECE PER BAG - PACK SIZE 10 BAGS

Type A : gancio semplice
simple hook
crochet simple

Type B : gancio prolungato per tensionare l'elastico
extensible hook to tension the elastic
crochet allongé pour tendre l'élastique

Forma smussata delle preincisioni
Its shape has no sharp edges
Sa forme est complètement émoussée



Art.251 INFILA ELASTICO

ELASTIC THREADER
POUR PASSER L'ÉLASTIQUE DANS LE SCIONS CREUX

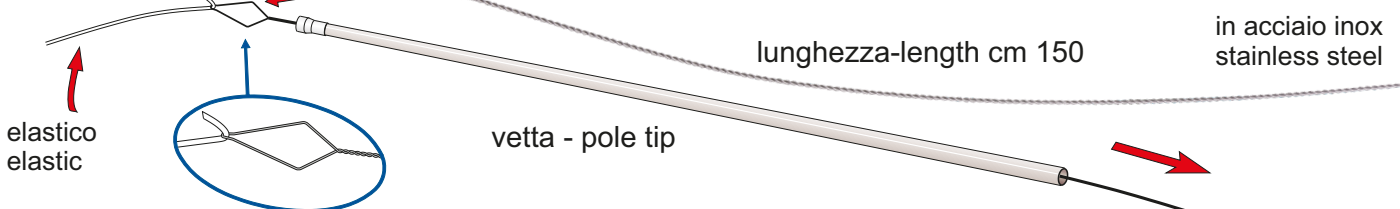

BUSTA DA 1 PEZZO - CONF.DA 10 BUSTE * 1 PIECE PER BAG - PACK SIZE 10 BAGS

Art.461

INFILA ELASTICO IN BOBINA ELASTIC THREADER IN SPOOL - PASSE ÉLASTIQUE



Treccia morbida in acciaio inox per facilitare il passaggio dell'elastico dentro il cimino. Dopo l'uso la treccia viene riavvolta nella sua pratica confezione a bobina. Due le misure disponibili per elastici di piccolo e grande diametro.



Stainless steel braid elastic threader, enables easy threading of elastic in pole sections. Available in the handy spool in two different sizes for small and large diameter of elastic.



Aiguille souple passe-élastique pour scion creux, conditionnée dans un pratique enrouleur plastique. Disponible en deux tailles pour petits et grands diamètres d'élastique.

BUSTA DA 1 PEZZO - CONFEZIONE DA 10 BUSTE
1 PIECE PER BAG - PACK SIZE 10 BAGS

Mis.	per elastico
1	Ø 1,4 mm max
2	oltre-over Ø 1,4

MISURA 2
BIG SIZE

MISURA 1
SMALL SIZE



Art.310

SCALETTA REGOLABILE

ADJUSTABLE ELASTIC TENSIONER



Sistema di aggancio regolabile per elastico. Leggerissime, consentono la regolazione della tensione dell'elastico. Prodotte in cinque diverse misure per ogni tipo di canna.



Adjustable elastic tensioner. Ultra light, permits to increase or decrease the elastic tension. Produced in five sizes for a full adaptability.



Embase réglable d'accrochage pour élastique, en cinq tailles pour une complète adaptation. Ultra légère, permet d'ajuster la tension de l'élastique.

Mis.	da mm	a mm
1	8	9,8
2	10,2	14,5
3	14,9	20
3,5	13,0	21
4	20,6	26

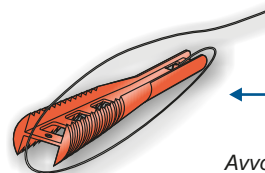

Avvolgere per tensionare l'elastico
Wind the elastic to increase the tension
Enrouler l'élastique pour augmenter la tension

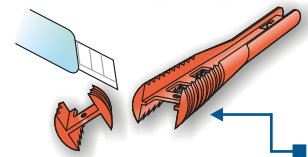

Grande superficie di appoggio
Large contact surface
Grande surface de contact

BUSTA DA 1 PZ - CONF. DA 10 PEZZI
1 PIECE PER BAG - PACK SIZE 10 PIECES

Art.68

SCALETTONE per elastico grosso

BASE PLUG FOR BIG ELASTIC - ÉCHELLE POUR GRAND ÉLASTIQUE



Scalette ideali per elastici di grande diametro. La loro lunghezza può essere variata in base al diametro e alla lunghezza dell'elastico da avvolgere.



Suitable for big diameter elastics. They can be shortened according to the diameter and length of the elastics they wind.



Idéales pour élastiques à grand diamètre. Leur longueur peut être réglée selon le diamètre et la longueur de l'élastique à enrouler.

Mis.	da mm	a mm
1	13	20
2	20	28

BUSTA DA 1 PEZZO - CONF. DA 10 BU.
1 PIECE PER BAG - PACK SIZE 10 BAGS

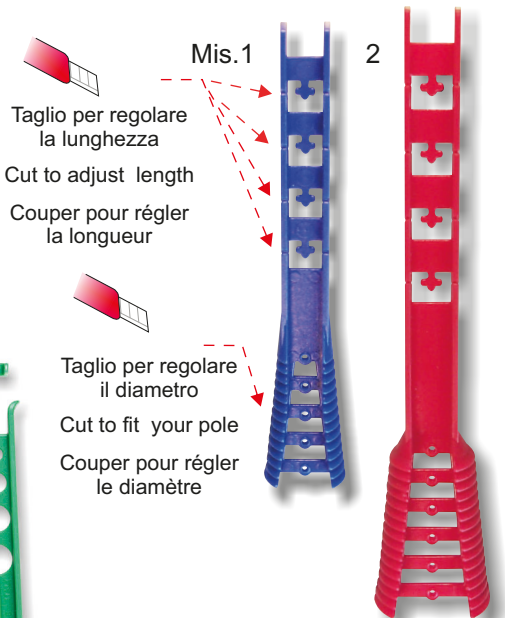

Taglio per regolare la lunghezza
Cut to adjust length
Couper pour régler la longueur

Taglio per regolare il diametro
Cut to fit your pole
Couper pour régler le diamètre

Art.425

CONOPLUS



Dispositivo conico per l'aggancio ed il tensionamento dell'elastico con scaletta integrata di grande capienza. Superleggero e resistente, viene facilmente rimosso dalla canna grazie all'apposito estrattore. Mis. 2,5: misura speciale studiata per elastici cavi e pieni di grande diametro.



Conoplus system for the hooking and adjustment of elastic inside the section. Ultra lightweight and strong. Large capacity winder. Conoplus is quickly and simply removable with the proper extractor. Size 2,5: special size designed for big and hollow elastics.





Système Conoplus pour la fixation de l'élastique intérieure, permet le réglage de la tension de l'élastique. Ultra-léger et extra robuste il est muni d'une échelle de grande capacité. Le dispositif Conoplus Extractor permet l'extraction du cône facilement. Taille 2,5: Taille spéciale étudiée pour élastiques grands et creux.



Mis.	da mm	a mm
1	8	13
2	13,5	21,0
2,5	16,0	24,0
3	21,5	30,5

BUSTA DA 1 PEZZO - CONF. DA 10 BU.
1 PIECE PER BAG - PACK SIZE 10 BAGS

Art.426 **ESTRATTORE CONOPLUS**
CONOPLUS EXTRACTOR



-  Dispositivo per l'estrazione rapida del Conoplus dalla canna.
-  Special extractor to quickly remove the Conoplus from rod.
-  Dispositif qui permet facilement l'extraction du Conoplus de la canne.

Estrattore - Extractor
Lunghezza - Length cm 27

BUSTA DA 1 PEZZO - CONF.DA 10 BU.
 1 PIECE PER BAG - PACK SIZE 10 BAGS



Art.367 **COMBI**
COMBO SYSTEM



-  Dispositivo combinato per l'aggancio ed il tensionamento dell'elastico. Superleggero e resistente. Bloccaggio a baionetta super sicuro. Scalette più capienti.
-  Combo system for the hooking and adjustment of elastic inside the section. Ultra light and strong. Ultra safe bayonet fitting. Capacious winders.
-  Système Combi pour la fixation de l'élastique intérieur, permet le réglage de la tension de l'élastique. Ultra-léger et résistant. Joint à baïonnette très sûr. Échelle d'une grande capacité.

Mis.	da mm	a mm
1	9	13
2	13,0	17,0
2,5	14,5	21,0
3	17,5	24
4	24,5	31,5

BUSTA DA 1 PEZZO - CONF.DA 10 BUSTE
 1 PIECE PER BAG - PACK SIZE 10 BAGS





Art.694 **PTFE CURVED**

-  Boccola in puro PTFE curvo realizzata per agevolare il recupero dell'elastico all'esterno della canna durante il combattimento. Garantisce la massima scorrevolezza dell'elastico sia pieno che cavo. Altre caratteristiche: piccola, leggera, design elegante con sporgenza ridotta. Il montaggio sulla canna, grazie ad un esclusivo sistema a scatto, è semplicissimo, veloce, sicuro e non richiede uso di colla. La confezione comprende 2 utili blocca-elastico.
-  Bush in pure curved PTFE realized to facilitate the elastic retrieving outside the pole during the fight. It ensures the maximum smoothness of both solid and hollow elastics. Other features: small, lightweight, elegant design with reduced overhang. The mounting on the pole, thanks to an exclusive click system, is very easy, quick, secure and doesn't need the use of glue. Supplied with 2 useful elastic holders.
-  Tulipe en pur PTFE courbe réalisée pour faciliter la récupération de l'élastique à l'extérieur de la canne pendant le combat. Elle garantit la fluidité maximum de l'élastique soit creux ou plein. Autres caractéristiques: petite, légère, design élégant avec saillie réduite. Le montage sur la canne, grâce à un exclusif système à encliquetage, est très facile, rapide, sûr et ne nécessite pas l'utilisation de colle. Livrées avec 2 utiles fixe-élastique.

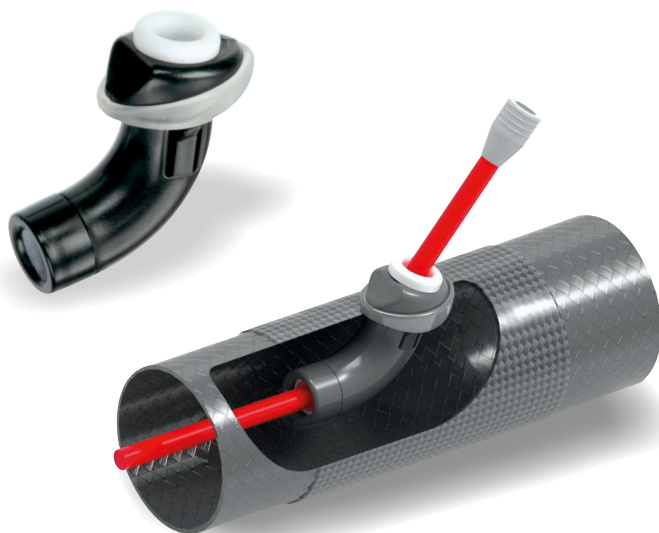
BUSTA DA 1 PEZZO - CONFEZIONE DA 10 PEZZI
 1 PER BAG - PACK SIZE 10 BAGS





Art.81 **SELLETTA PER ELASTICO** ELASTIC SAVER - PROTÈGE ÉLASTIQUE

-  Selletta in gomma per proteggere l'elastico da eventuali danneggiamenti quando la roubaissienne viene riposta.
-  Useful to avoid nicks on the elastic while the pole is set down. Produced in soft material.
-  Utile pour protéger l'élastique durant le rangement de la canne. Fabriqué en caoutchouc.

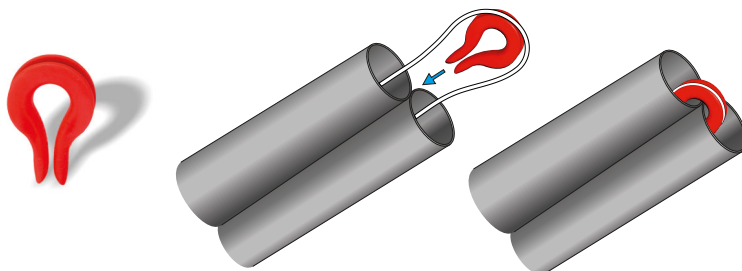
BUSTA DA 6 PEZZI - CONF.DA 10 BUSTE
 6 PIECES PER BAG - PACK SIZE 10 BAGS





Art.698 **SELLETTA MAXI**
MAXI ELASTIC SAVER

-  Selletta in gomma studiata per elastici di grande diametro. Protegge l'elastico da eventuali danneggiamenti quando la roubaissienne viene riposta.
-  Elastic saver designed for big diameter elastics. Useful to avoid nicks on the elastic while the pole is set down. Produced in soft material.
-  Protège élastique, spécialement conçu pour les élastiques de grand diamètre. Utile pour protéger l'élastique pendant le rangement de la canne. Fabriqué en caoutchouc.

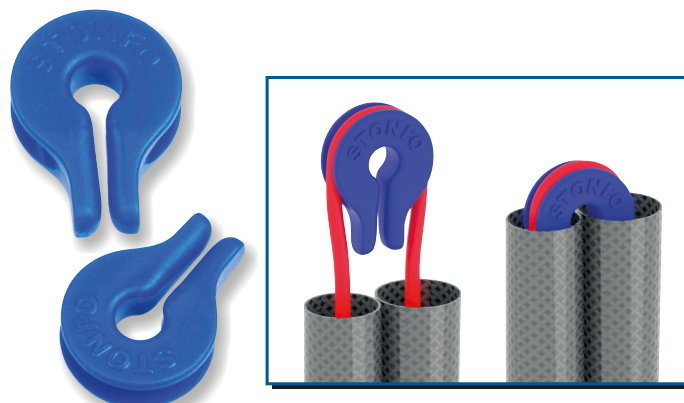
BUSTA DA 5 PEZZI - CONFEZIONE DA 10 BUSTE
 5 PER BAG - PACK SIZE 10 BAGS



Art.240 LUBRIFICANTE PER ELASTICO
ELASTIC LUBRICANT

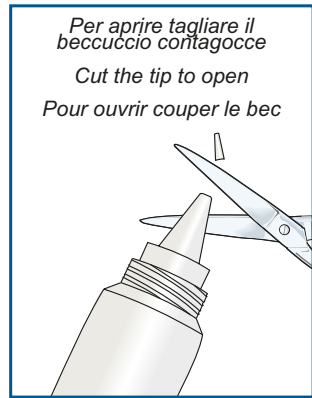

-  *Olio speciale per elastici da roubaisienne per favorire lo scorrimento nel vettino. Resistente all'acqua.*
-  *Special lubricant for pole elastic to allow smooth passage through the tip. Water resistant.*
-  *Huile spéciale pour élastique de roubaisienne. Favorise le glissement dans le scion. Résiste à l'eau.*

CONT. 10 GR



BUSTA DA 1 PEZZO - CONFEZIONE DA 10 BUSTE
1 PIECE PER BAG - PACK SIZE 10 BAGS

Art.24S ELASTICO ROUBAISIEENNE
ROUBAISIEENNE ELASTIC



-  *Elastico per roubaisienne ad alta resistenza in lattice naturale. Lunghezza mt 4,4.*
-  *Natural latex pole elastics. High strength. 4,4 metres on a winder.*
-  *Elastiques pour roubaisienne en latex naturel très résistants. Ploirs de 4,4 mètres.*

Misure - Sizes
Ø mm 0,75
Ø mm 0,9
Ø mm 1,0
Ø mm 1,25



BUSTA DA 1 PEZZO - CONFEZIONE DA 10 BUSTE
1 PIECE PER BAG - PACK SIZE 10 BAGS

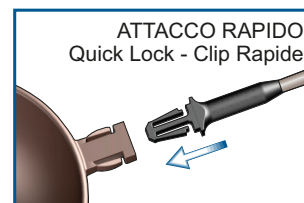

Art.493 COPPETTE STONFO
POLE FEEDING CUPS

-  *Coppette per la pasturazione con roubaisienne. Prodotte in materiale plastico estremamente leggero, sono munite di uno speciale dispositivo di attacco rapido. Kit composto da tre misure di coppette (ml 80 -150 -250) e tre misure di adattatori.*
-  *Pole feeding cups. Made of super light-weight plastic material, they clip quickly on the pole thanks to the special adaptor. Kit with three sizes cups (ml 80 -150 -250) and three sizes of adaptors.*
-  *Couppelles amorçage. Produites en matériau plastique ultra-léger, sont très rapide à mettre en place grâce à le spécial clip. Kit avec trois tailles de coupelles (ml 80 -150 -250) et trois clips.*



BUSTA DA 3 PEZZI - CONFEZIONE DA 10 BUSTE
3 PIECES PER BAG - PACK SIZE 10 BAGS

Art.122 CLIP ROUBAISIEENNE

-  *Clip a molla con guancette in gomma antiscivolo per fissare la lenza, anche se più lunga, sulle punte della roubaisienne. La busta contiene la misura piccola e la misura media.*
-  *Pole clips with gripper pads, suitable to hold the long line on the roubaisienne pole kit. The bag contain 2 clips, small size and medium size.*
-  *Clip pour cannes, avec contacts caoutchouc anti-glisse, pour bloquer la ligne, aussi si plus longue, sur le Kit. Sachet de 2 pieces, taille petite et taille moyenne.*



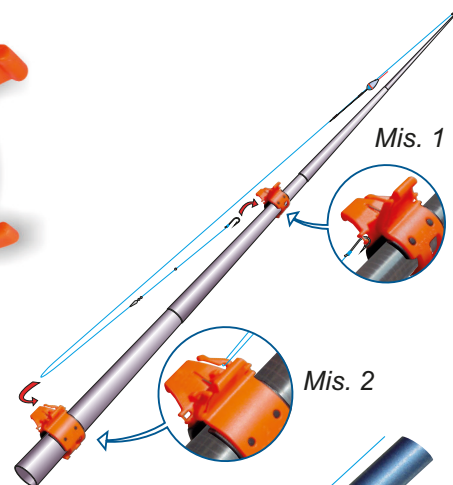

Misura-Size	Ø canna - pole
<input checked="" type="checkbox"/> 1 Small	6 - 22 mm
<input checked="" type="checkbox"/> 2 Medium	14 - 33 mm
<input type="checkbox"/> 3 Big	20 - 43 mm



BUSTA DA 2 PEZZI - CONFEZIONE DA 10 BUSTE
2 PIECES PER BAG - PACK SIZE 10 BAGS

Art.123 CLIP STONFO 2 da Ø 14 a Ø 33 mm

-  *Clip a molla, misura media, con guancette in gomma antiscivolo. Blocca il filo lungo la canna. Ottima per fissare la lenza, anche se più lunga, sulle punte della roubaisienne.*
-  *Pole clips medium size with gripper pads. Keep poles rigged and ready to use. Suitable to hold the long line on the roubaisienne pole kit.*
-  *Clip pour cannes, taille moyenne, avec contacts caoutchouc anti-glisse. S'adapte sur la canne pour accrocher l'hameçon. Idéal pour bloquer la ligne, aussi si plus longue, sur le Kit.*

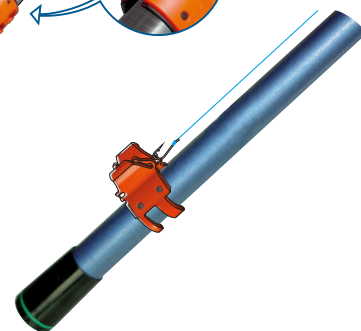

BU. DA 2 PZ - CONFEZIONE DA 10 BU.
2 PIECES PER BAG - PACK SIZE 10 BAGS

Art.124 **CLIP STONFO 3 da Ø 20 a Ø 43 mm**

 Clip a molla, misura grande, con guancette in gomma antiscivolo. Blocca il filo lungo la canna. Ottima per fissare la lenza, anche se più lunga, sulle punte della roubaisienne.

 Pole clips big size with gripper pads. Keep poles rigged and ready to use. Suitable to hold the long line on the roubaisienne pole kit.

 Clip pour cannes, taille grande, avec contacts caoutchouc anti-glisse. S'adapte sur la canne pour accrocher l'hameçon. Idéal pour bloquer la ligne, aussi si plus longue, sur le Kit.





Misura-Size	Ø canna - pole
<input type="checkbox"/> 1 Small	6 - 22 mm
<input type="checkbox"/> 2 Medium	14 - 33 mm
<input checked="" type="checkbox"/> 3 Big	20 - 43 mm

BU. DA 2 PZ - CONFEZIONE DA 10 BU.
2 PIECES PER BAG - PACK SIZE 10 BAGS

Art.121 **CLIP STONFO 1 da Ø 6 a Ø 22 mm**

 Clip a molla con guancette in gomma antiscivolo. Studiata appositamente per la pesca alla trota. Sostiene saldamente la bombarda, striscio etc. sulla canna durante gli spostamenti. Blocca il filo lungo la canna da pesca quando viene riposta.

 Rod clip with gripper pads. Ideal for trout fishing. Keep rods rigged and ready to use. Hold the fishing line along the rod.

 Clip pour cannes avec contacts caoutchouc anti-glisse. Étudié pour la pêche à la truite. Bloque la ligne ou la bombette pendant les déplacements. S'adapte sur la canne pour accrocher l'hameçon.



BU. DA 2 PZ - CONFEZIONE DA 10 BU.
2 PIECES PER BAG - PACK SIZE 10 BAGS

Art.448 **LEGA AMI HOOK TYER - MONTE HAMEÇONS**





MISURA PICCOLA - SMALL SIZE



MISURA GRANDE - BIG SIZE

 Lega ami manuale con impugnatura in gomma prodotto in due diverse misure: la misura piccola è stata studiata per legare con estrema facilità ami piccolissimi dalla misura nr. 14 alla 28, mentre la grande è adatta per ami dal nr. 6 al 18. Fornito completo di dettagliate istruzioni per l'uso.

 Device with soft touch handle for tying fishing hook to the line. Produced in two different sizes: the small one is specially designed for very small hook sizes from nr. 14 to 28, the big one is suitable for hook sizes from nr. 6 to 18. Supplied with full instructions.

 Monte hameçons en deux tailles avec poignée soft touch. La petite taille est étudiée pour hameçons très petits de n°14 jusqu'au 28, la grande pour hameçons de n°6 à 18. Livré avec notice d'emploi.

BUSTA DA 1 PEZZO - CONFEZIONE DA 10 BUSTE
1 PIECE PER BAG - PACK SIZE 10 BAGS

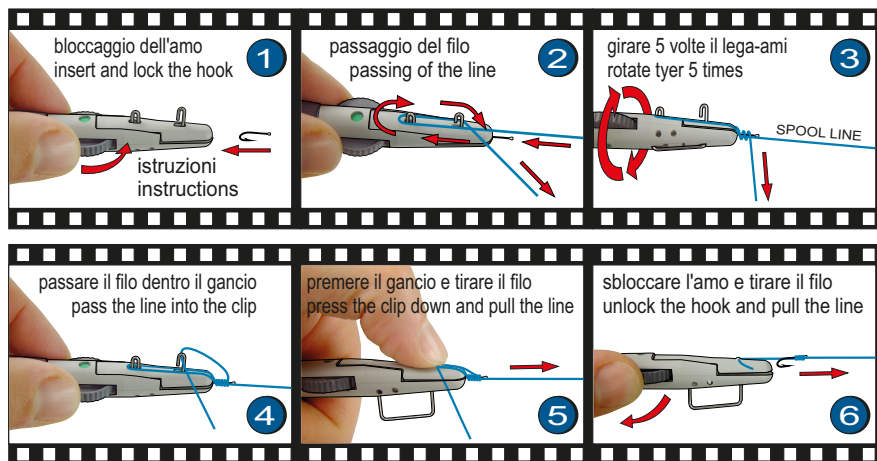



Art.738 **MICRO LOOP TYERS**

UTENSILI PER MICRO ASOLE
OUTILS POUR MICRO BOUCLES

4 mm

6 mm

 Utensili per la creazione di piccolissime asole ideali per terminali ed hair rigs. La misura piccola permette la legatura di asole di 4 mm, mentre la grande di 6 mm.

 Tools to make very small loops ideal for hooklengths and hair rigs. The small size allows you to tie 4 mm loops, while the large 6 mm.

 Outils pour créer des boucles très petites, idéales pour les bas de ligne et hair rigs. La petite taille permet la réalisation de boucles de 4 mm, tandis que la grande de 6 mm.

BUSTA DA 2 PZ. (MIS. PICCOLA+GRANDE) - CONF. DA 10 BUSTE
2 PCS PER BAG (SIZE SMALL+LARGE) - PACK SIZE 10 BAGS



Art.76 CALIBRO PER ASOLE

LOOP DEVICE - CALIBRE À BOUCLES

 Permette la realizzazione di asole perfettamente uguali e della grandezza voluta. (5-25 mm)

 Allows to tie perfect loops of the desired size. (5-25 mm)

 Il permet de réaliser des boucles identiques et de la dimension désirée. (5 - 25 mm)

BUSTA DA 1 PEZZO - CONF.DA 10 BUSTE
1 PIECE PER BAG - PACK SIZE 10 BAGS

1

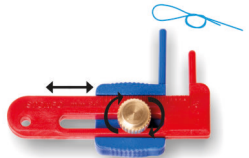

Regolare il calibro alla lunghezza voluta agendo sul pomello a vite.

Adjust the calibre to the desired length by turning the knob.

Régler le calibre à la longueur désirée en tournant le pommeau à vis.

2

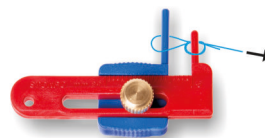

Inserire l'asola come mostrato in figura e tirare il filo.

Insert the loop, as in the image, and pull the line.

Insérer la boucle, comme dans le dessin, et tirer le fil.

3

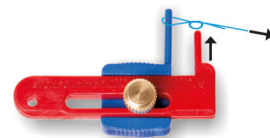

Sfilare l'asola dal perno più corto e serrare il nodo.

Remove the loop from the short pin and tie the knot.

Enlever la boucle du petit pivot et serrer le nœud.

DOSAPIOMBO SHOT DOSER - DOS PLOMB

Art.18-1 Misura piccola
Small size

Art.18-2 Misura grande
Big size

Art.18-1S Misura P blister
Small size blister

Art.18-2S Misura G blister
Big size blister

 Utilissimo per montare le lenze in casa, serve a determinare con precisione la quantità di piombo che tiene un galleggiante. La misura piccola è adatta per galleggianti con deriva sottile in acciaio o grafite mentre la misura grande per quelli con deriva più grossa.

 Shot doser to shot delicate pole floats before assembling the rig. Using this ingenious neutral buoyancy device you can make rigs at home and store them on winders ready for immediate use when required.

 Doseur permettant de déterminer la quantité de plomb que chaque flotteur peut tenir. Petit modèle pour les flotteurs à quille très fine, grand modèle pour les flotteurs à quille moyenne et forte. Utilisation très facile.

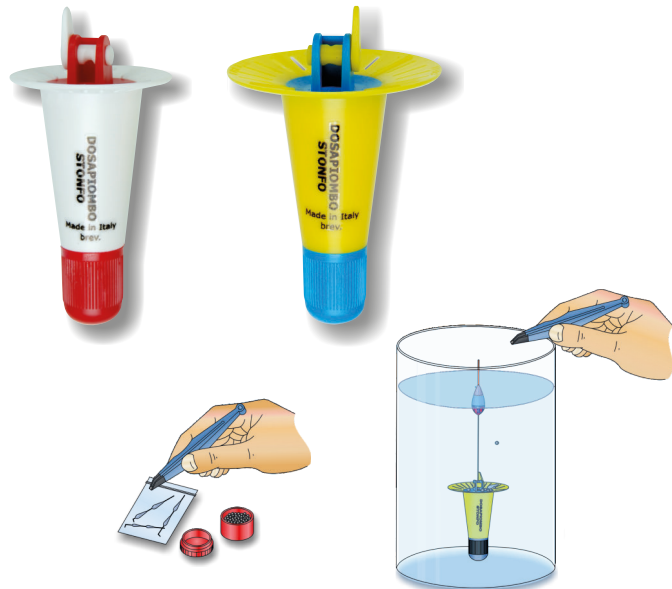

CONFEZIONE DA 10 PEZZI - PACK SIZE 10 PIECES

Art.604 CALIBRONE STONFO

VERSIONE SMALL
SMALL HOOKS VERSION

VERSIONE BIG
BIG HOOKS VERSION

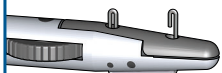

Hook sizes - Per ami 28-10

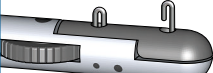



Hook sizes - Per ami 18-2

 Vera e propria macchina di precisione per la costruzione dei finali. Il Calibrone permette infatti con la massima semplicità di legare l'amo su un terminale che sarà esattamente della lunghezza stabilita da un minimo di 10 cm fino alla misura desiderata. Il Calibrone è munito inoltre di un dispositivo per fare le asole della dimensione voluta. Disponibile in due versioni per ami piccoli e grandi e su richiesta modello con scala in pollici. Fornito completo di dispositivo fermabobina per un perfetto tensionamento del filo, asta di prolunga, penna calamitata per ami e istruzioni per l'uso.

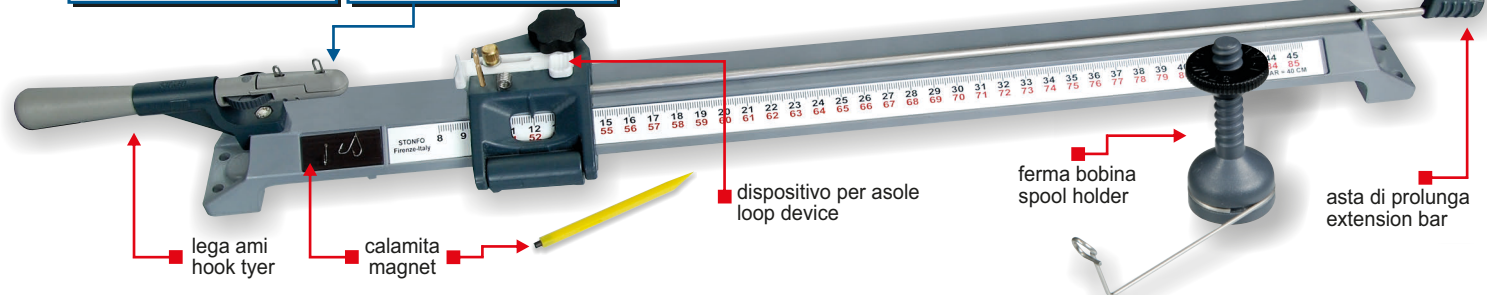
CONFEZIONE DA 1 PEZZO - PACK SIZE 1PIECE





 Hooklengths tyer precision machine. The Calibrone permits to tie hooklengths from 10 cm to as long as you desire easily, and it has also a loop tyer device for tying small loops. Available in two versions for small and big hooks. Inches scale version is available on request. Supplied with spool holder for a perfect line tension, extension bar, magnetic pen for hooks and instructions for use.

 Monte hameçons de précision qui vous permet de faire des bas de ligne de 10 cm jusqu'à la longueur désirée. Le Calibrone est aussi muni d'un dispositif pour réaliser des boucles toujours identiques. Disponible en deux versions pour hameçons petits et grands. Une version avec règle graduée en pouces est disponible sur demande. Livré avec un porte-bobine pour une parfaite tension du fil, tige de rallonge, stylo aimanté pour hameçons et notice d'emploi.

Art.602 FERMABOBINA SPOOL HOLDER

 Dispositivo con frizione magnetica consente un perfetto tensionamento del filo. Utilissimo per facilitare la legatura degli ami e per la realizzazione di varie montature. Viene fornito con guidafile in acciaio inox e due dischi metallici adesivi.

 Spool holder device with magnetic drag for a perfect line tension. Useful to tie hooks easily and make various types of rigs. Supplied with stainless steel guide-line and two adhesive metal discs.

 Dispositif porte-bobine à frein magnétique pour une parfaite tension du fil. Il est très utile pour faciliter la réalisation du bas de ligne et autres montages différents. Livré avec guide-fil en acier inox et deux disques métalliques adhésifs.

BUSTA DA 1 PEZZO - CONFEZIONE DA 10 BUSTE
1 PIECE PER BAG - PACK SIZE 10 BAGS

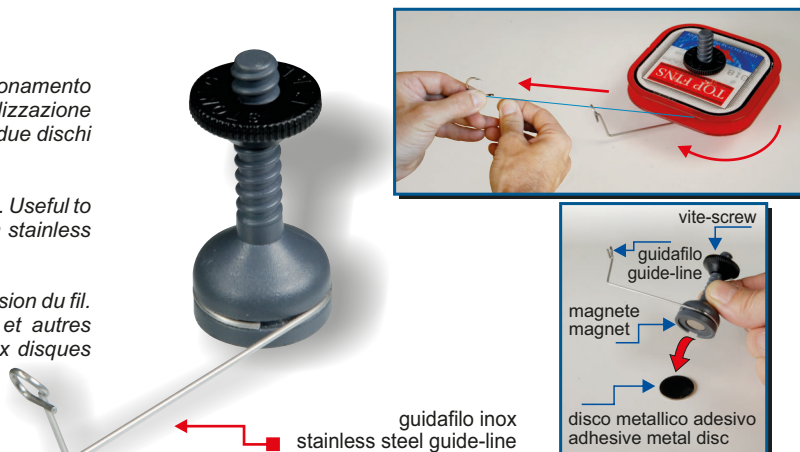

Art.627 **PORTAFINALI 200** dim.10x23,5x1,7 cm
Lunghezza finali - Hooklengths length 7 -10 -12,5 -15 -20 cm

Art.628 **PORTAFINALI 300** dim.10x33,5x1,7 cm
Lunghezza finali - Hooklengths length 10 -15 -20 -25 -30 cm

 I Portafinali 200 e 300 sono contenitori studiati per riporre e proteggere una grande quantità di finali della lunghezza da cm 7 a 30 e loro multipli. Compatti e molto leggeri hanno 13 posizioni di fissaggio e possono contenere oltre 100 finali pronti all'uso. I piolini di sostegno sono di dimensione adeguata sia nel diametro che nella lunghezza per permettere di alloggiare ami ed asole anche di grandezza ridotta. La lunghezza del finale è chiaramente indicata all'interno del contenitore.

 The Portafinali 200 and 300 are hook lengths storage boxes designed to hold and protect a large amount of hook lengths in size from cm 7 to 30 and its multiples. Compact and ultralight they are provided with 13 fixing positions and can hold over 100 hook lengths ready to use. The support pegs size is adequate both in diameter and length to allow the fixing of even small size hooks and loops. The length of hook lengths is clearly indicated inside the storage boxes.

 Les Portafinali 200 et 300 sont des boîtes à bas de ligne spécialement conçues pour ranger et protéger une grande quantité de bas de ligne de 7 à 30 cm et leurs multiples. Compactes et très légères avec 13 positions de fixation, elles peuvent contenir plus de 100 bas de ligne prêts à l'emploi. Les crochets sont de taille adéquate pour placer des micro hameçons et des micro boucles. La longueur de bas de ligne est clairement indiquée sur l'intérieur des boîtes.

BUSTA DA 1 PEZZO - CONFEZIONE DA 5 BUSTE
1 PIECE PER BAG - PACK SIZE 5 BAGS

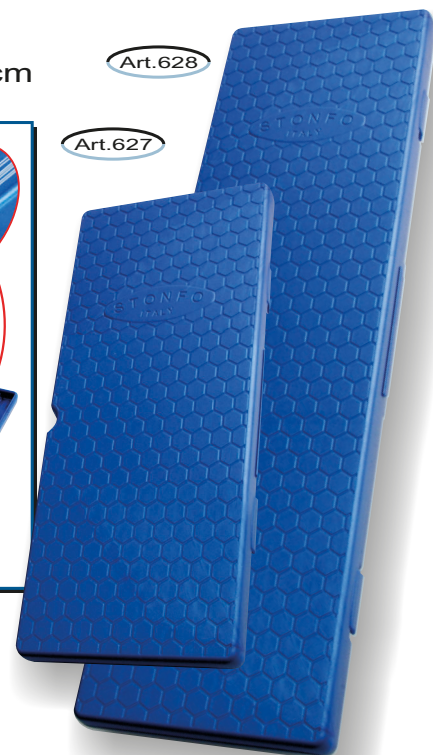
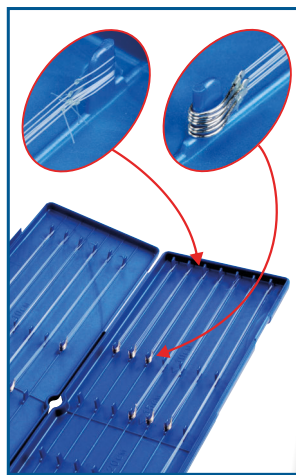

Art.8 **PINZETTA PRENSILE** PLIER

 Pinzetta multiuso con punte in materiale non rigido.

 Pliers with soft tips.

 Pince multifonction avec pointes souples.

BUSTA DA 1 PEZZO - CONFEZIONE DA 10 PEZZI
1 PIECE PER BAG - PACK SIZE 10 PIECES

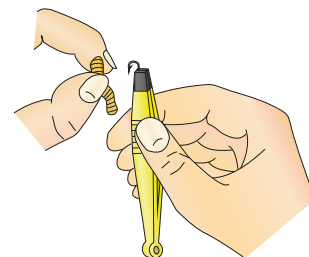

LEVAPIOMBO
SHOTS REMOVER - PINCE À PLOMBS

Art.19 **LEVAPIOMBO** Art.19S **LEVAPIOMBO IN BLISTER**

 Toglie i pallini di piombo dalla lenza senza danneggiare il filo, è inoltre munito di due lamelle che permettono l'allentamento dei piombini rendendone possibile lo scorrimento sulla lenza. Ottimo anche per stringere still o piombini sulla lenza.

 A double tool in one. One end of the tool is used to remove all sizes of shot and the other end is used to slide the shot without damaging the line. It also serves to tighten Still or shots on the line.

 Permet d'enlever, déserrer ou déplacer les plombs sans abîmer le fil. Utile aussi pour serrer les plombs sur le fil.

CONFEZIONE DA 10 PEZZI - PACK SIZE 10 PIECES

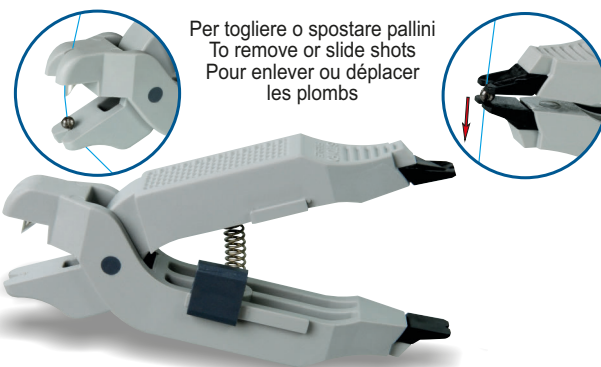

Art.592 **LEVONE** BIG SIZE SHOT REMOVER

 Pinza molto robusta adatta per togliere dal filo pallini di piombo di grande dimensione. La pinza dal lato opposto permette inoltre di allentare i pallini permettendone il loro libero scorrimento senza danneggiare il filo.

 Very strong shot plier specially designed for big shots. One end of the tool is used to remove all sizes of shot and the other end is used to slide the shot without damaging the line.

 Pince très solide spécialement conçue pour enlever les gros plombs de la ligne. L'autre extrémité de l'outil est utilisée pour déserrer et déplacer les plombs sans causer de dommage au fil.

BUSTA DA 1 PEZZO - CONFEZIONE DA 5 BUSTE
1 PIECE PER BAG - PACK SIZE 5 BAGS

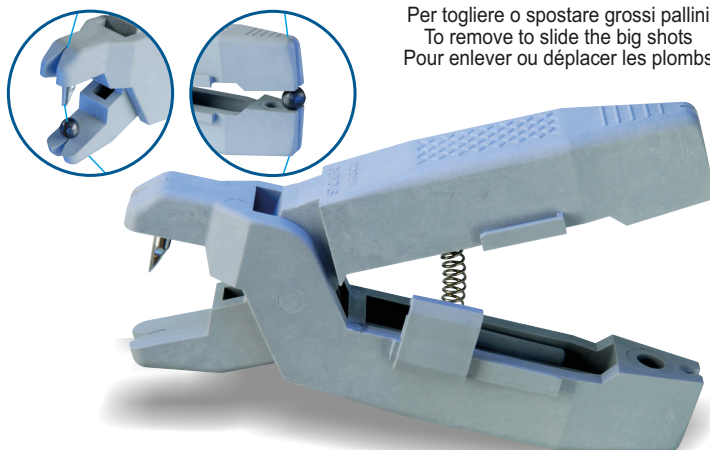

Art.278 ELASTIC RING NERO
ELASTIC RING BLACK COLOUR

 Anello elastico paracolpi prodotto in sei misure. Grazie alla sua elasticità può essere applicato sulle canne con gli anelli già montati. Commercializzato in busta da 12 pezzi assortiti in varie misure.

 Six different sizes of elastic black ring-shock absorber. Easy fitting and removal. 12 pieces per bag in miscellaneous sizes.

 Bague élastique pour protéger les anneaux des cannes. Sachet de 12 bagues en tailles assorties.

BUSTA DA 12 PEZZI - CONFEZIONE DA 10 BUSTE
12 PIECES PER BAG - PACK SIZE 10 BAGS



Art.277 ELASTIC RING COLORATO
ELASTIC RING FLUO COLOURS

 Anelli elastici per fissare la lenza lungo la canna. Prodotti con materiale morbidissimo, che non danneggia l'amo, in sei misure per ogni tipo di canna. Grazie alla sua colorazione fluorescente molto visibile è ottimo per evidenziare gli innesti della roubaisienne.

 Six different sizes for all fishing rods. Ideal to hook the line along the rod. Fast and coloured system to mark the pole "roubaisienne" sections.

 Très utile pour accrocher l'hameçon sur la canne et pour mettre en évidence, avec ses couleurs, les emboîtements de la canne.

BUSTA DA 10 PEZZI - CONFEZIONE DA 10 BUSTE
10 PIECES PER BAG - PACK SIZE 10 BAGS



Art.730 LURE-LINE HOLDER

 Gancetto studiato per bloccare l'amo alla canna da pesca. Si applica alla canna per mezzo di o-ring forniti in varie dimensioni. La sua forma speciale lo rende inoltre particolarmente adatto per avvolgere il finale sulla canna da Tenkara.

 Holder designed to secure the hook to the fishing rod. It can be attached to the rod thanks to o-rings supplied in different sizes. Its special shape makes it also particularly suitable to wind the tippet on Tenkara rods.

 Crochet conçu pour fixer l'hameçon à la canne à pêche. Il s'applique à la canne au moyen de o-ring fournis en différentes tailles. Sa forme spéciale le rend aussi particulièrement adapté pour enrouler le bas de ligne sur la canne de Tenkara.

BUSTA DA 2 PEZZI - CONFEZIONE DA 10 BUSTE
2 PIECES PER BAG - PACK SIZE 10 BAGS



SLAMATORI STANDARD
STANDARD DISGORGERS - DÉGORGEOIRS STANDARD

Art.281 Slamatore Standard Piccolo
 Small size Standard Disgorger
 Dégorgeoir Standard petit





Art.282 Slamatore Standard grande
 Big size Standard Disgorger
 Dégorgeoir Standard grand

CONFEZIONATI IN BUSTE DA 40 PEZZI
PACK SIZE 40 PIECES

CONFEZIONATI IN BUSTE DA 40 PEZZI
PACK SIZE 40 PIECES

SLAMATORE LITTLE

 Slamatore con due testine (micro e piccola) particolarmente indicato per piccoli ami. Il taglio delle testine è in linea con la sagoma dello slamatore per agevolare la presa del filo. Prodotto in materiale plastico speciale che non danneggia l'amo.

 Double headed disgorger, specially designed for small hooks. The oblique cut aligned to the heads shape allows a quick line hold.

 Dégorgeoir à double tête idéal pour petits hameçons. Les têtes, à prise rapide du fil, sont profilées pour une utilisation très facile.

Art.252 Little disgorger

Art.252S Little disgorger busta da 1 pezzo





CONFEZIONE DA 30 PEZZI * PACK SIZE 30 PIECES

SLAMATORI STONFO

STONFO DISGORGERS - DÉGORGEOIRS STONFO

 Slamatori con testina a presa rapida del filo e punta in acciaio inox affilatissima ideale per sciogliere nodi, forare gli anellini dei galleggianti etc. La punta è protetta da un cappuccio con clip.

 High quality disgorgers with useful pointed stainless steel end to untie knots and clean float rings and hook eyes.

 Dégorgeoirs stylo avec têtes à prise rapide du fil et à l'autre extrémité une pointe en acier inox protégée par un capuchon permet de démêler la ligne, déboucher les œillets des flotteurs etc.

CONFEZIONATI IN BUSTE DA 20 PEZZI
PACK SIZE 20 PIECES

SLAMATORI CON PROLUNGA EXTENSION DISGORGERS

 Slamatori muniti di prolunga ideali per slamare pesci di grande taglia catturati con piccoli ami. (2 misure)

 Extension disgorgers suitable to disgorge big fishes caught using small hooks. (2 sizes)

 Dégorgeoir avec rallonge idéal pour la pêche de grands poissons par petits hameçons. (2 mesures)

CONFEZIONE DA 10 PEZZI - PACK SIZE 10 PIECES

Art.273 SLAMATORE MATCH MATCH DISGORGER - DEGORGEOIR MATCH

 Slamatore di alta qualità con due testine di ridotte dimensioni. Il taglio delle testine è in linea con la sagoma dello slamatore per agevolare la presa del filo. Prodotto con materiale che non danneggia l'amo è inoltre munito di punta in acciaio inox scioglinodo.

 High quality disgorgers with double head, specially designed for small hooks. The oblique cut aligned to the heads shape allows a quick line hold. It is provided with useful pointed stainless steel end to untie knots and clean float rings and hook eyes.

 Dégorgeoir d'haute qualité à double tête à prise rapide du fil. Il est équipé d'une pointe en inox qui permette de démêler vos perruques.

CONF. DA 10 PEZZI - PACK SIZE 10 PIECES

SLAMATORI ELITE

 Slamatori di alta qualità disponibili in due diverse misure. Il taglio delle testine è in linea con la sagoma degli slamatori per agevolare la presa del filo. Prodotti con materiale che non danneggiano l'amo sono inoltre muniti di punta in acciaio inox scioglinodo.

 High quality disgorgers with double head, produced in two sizes. The oblique cut aligned to the heads shape allows a quick line hold. They are provided with useful pointed stainless steel end to untie knots and clean float rings and hook eyes.

 Dégorgeoirs d'haute qualité à double tête à prise rapide du fil. Ils sont équipés d'une pointe en inox qui permette de démêler vos perruques.

La silhouette a cuneo delle testine permette di slamare anche i pesci che tengono la bocca tenacemente chiusa, inoltre il taglio obliquo in linea con la sagoma delle testine permette una rapida presa del filo anche in totale assenza di luce.

Thanks to the wedge-shaped heads also fish with firmly closed mouth can be easily unhooked. The oblique cut aligned to the heads shape allows to hold the line quickly, even in darkness.

La particolare chiusura a scatto, che consente l'unione delle due parti dello slamatore, assicura il posizionamento delle 2 testine nello stesso verso, pronte all'uso quando lo slamatore viene estratto dal taschino.

The special snap closure, assures the right position of the two heads. In this way when we take the disgorgers from the pocket the heads are ready for the right use.

Questa particolare unghiatura consente (una volta introdotta la punta nel nodo e fatta scorrere la lenza fino sopra all'unghiatura stessa) di prendere agevolmente il filo con le dita e sciogliere il nodo.

This special notch of the disgorgers allows (once inserted the steel point into the knot and slid the line up to the notch itself) to take easily the line between our fingers and undo the knot.

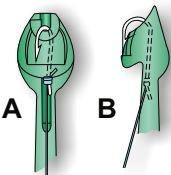

La particolare fattura del foro della testina obbliga l'amo in posizione centrale permettendo una sicura slamatura. (fig. A) Il bordino (B) protegge la punta e l'ardiglione dell' amo da una eventuale riallatura durante la fase di estrazione.

The recess of the head hold the hook in central position allowing a safe unhooking (pic. A). The head silhouette covers completely the hook point avoiding to hook again the fish while we remove the disgorgers (pic. B)

Punta in acciaio inox affilatissima per sciogliere nodi, forare anelli passafilo ostruiti dei galleggianti, etc....

A sharp stainless steel end can undo the knots and clean the rings of the floats in order to introduce the line.

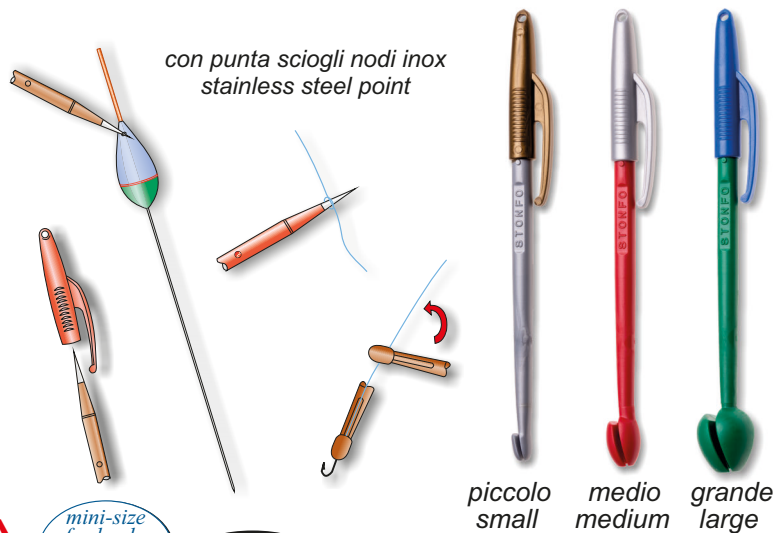

mini-size for hooks number 26 minimum Art.58



small-size for hooks number 22 minimum Art.59



punta sciogli nodi inox stainless steel point

- Art.235-1 Slamatore elite piccolo
Small size elite disgorgers
Dégorgeoir elite petit
- Art.235-2 Slamatore elite medio
Medium size elite disgorgers
Dégorgeoir elite moyen

SLAMATORI MARE SEA DISGORGERS - DÉGORGEOIRS MER

Art.16

Slamatore mare piccolo
Small size sea disgorger
Dégorgeoir mer petit



con punta sciogli nodi inox
stainless steel point

Art.17

Slamatore mare grande
Big size sea disgorger
Dégorgeoir mer gros



CONFEZIONATI IN BUSTE DA 20 PEZZI * PACK SIZE 20 PIECES



Slamatori mare, studiati per il pesce di mare e per tutti quei pesci che una volta allamati tendono a serrare la bocca rendendo difficoltosa la slamatura. La linea cuneiforme delle testine facilita l'apertura e la penetrazione dello slamatore consentendo una rapida esecuzione. Il modello piccolo, con testina molto ridotta è adatto per pesci con bocca molto piccola, mentre il modello grande, grazie alla prolunga di cui è dotato, permette di slamare in profondità.



Sea disgorgers, specially designed for sea-fishes and for all those fishes that, once hooked, tend to close the mouth tightly, making difficult the hooking operation. The cuneiform shape of its heads facilitates the mouth opening, allowing a very quick extraction of the hook. The small model, with a very thin head, is ideal for fishes with very small mouth. The large model, thanks to its extension, allows to unhook fishes even when very deeply hooked.



Dégorgeoirs mer, étudiés pour le poisson de mer et pour tous ces poissons qui, une fois pris à l'hameçon, tendent à serrer la bouche en rendant difficile retirer l'hameçon. La ligne cunéiforme de ses têtes facilite l'ouverture et la pénétrabilité en permettant l'extraction de l'hameçon en temps très vites. Le modèle petit, avec une tête très réduite, est idéal pour les petits poissons avec la bouche très petite. Le modèle grand, en raison de la rallonge, rend plus praticable son emploi et il permet de retirer l'hameçon plus en profondeur.

SLAMATORI BICOLORE

HIGH QUALITY DISGORGERS

Art.429	Misura - Size 1 - 2 - 3
Art.429-1	Misura - Size 4 - 5



Slamatori di alta qualità con impugnatura anatomica in materiale antiscivolo. Disponibili in cinque diverse misure.



High quality disgorgers with anatomic handle. Available in five sizes.



Dégorgeoirs d'haute qualité avec poignée anatomique. Cinq tailles.



BUSTA DA 1 PEZZO - CONFEZIONE DA 20 PEZZI
1 PIECE PER BAG - PACK SIZE 20 PIECES

Art.472

SLAMATORI Annoccatore Bicolore

TROUT DISGORGERS WITH PRIEST



Slamatori studiati per la pesca alla trota con annoccatore di grande efficacia. 2 misure.



Disgorgers with big efficiency priest studied for trout fishing. Two sizes.



Dégorgeoirs étudiés pour la pêche à la truite avec assommoir de grande efficacité. Deux tailles.



BUSTA DA 1 PEZZO - CONFEZIONE DA 10 PEZZI
1 PIECE PER BAG - PACK SIZE 10 BAGS

SLAMATORI BIG DISGORGERS TYPE "BIG"



Slamatori "Big", ideali per trote e grandi pesci.

Art.332-1

Piccolo
Small size



"Big" disgorgers, ideal for trout and big fish.

Art.332-2

Grande
Big size



Dégorgeoirs pour la truite et le gros poisson.

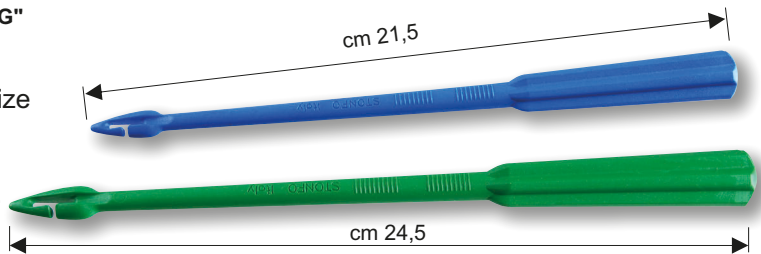

BUSTA DA 1 PEZZO - CONFEZIONE DA 10 BUSTE
1 PIECE PER BAG - PACK SIZE 10 BAGS

SLAMATORI BIG ANNOCCATORE

DISGORGERS WITH PRIEST



Slamatori "Big" con annoccatore, ideali per trote e grandi pesci.

Art.336-1

Piccolo
Small size



"Big" disgorgers with priest, ideal for trout and big fish.

Art.336-2

Grande
Big size



Dégorgeoirs avec assommoir pour la truite et le gros poisson.

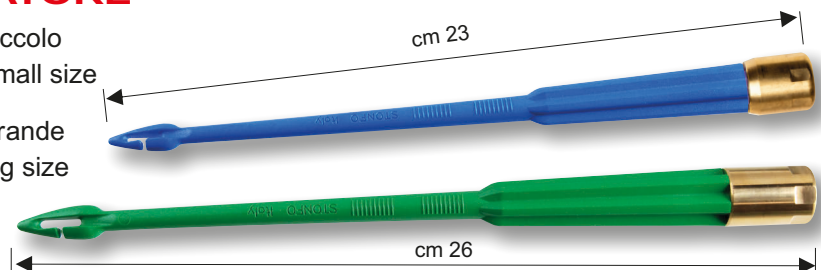

BUSTA DA 1 PEZZO - CONFEZIONE DA 10 BUSTE
1 PIECE PER BAG - PACK SIZE 10 BAGS

SLAMATORI busta da 1 pezzo



Slamatori di alta qualità. Il taglio delle testine è in linea con la sagoma degli slamatori per agevolare la presa del filo. Prodotti con materiale che non danneggiano l'amo sono inoltre muniti di punta in acciaio inox scioglinodo.



High quality disgorgers. The oblique cut aligned to the heads shape allows a quick line hold. They are provided with useful pointed stainless steel end to untie knots and clean float rings etc. etc.



Dégorgeoirs d'haute qualité à pris rapide du fil. Ils sont équipés d'une pointe en inox qui permette de démêler vos perruques.



BUSTA DA 1 PZ.-CONF.DA 20 PEZZI
1 PER BAG- PACK SIZE 20 BAGS

BUSTA DA 1 PZ.-CONF.DA 10 PEZZI
1 PER BAG- PACK SIZE 10 BAGS

Art.665 **SLAMA RELEASER** FOR TROUT AREA



Grazie a questi slamatori e all'utilizzo di ami senza ardiglione è possibile slamare il pesce direttamente in acqua senza toccarlo. Muniti di sistema telescopico con blocco a cursore per ridurre la lunghezza quando non in uso. Sono disponibili in due diverse misure con istruzioni per l'uso.



Thanks to these disgorgers and to the use of barbless hooks, you can unhook a fish while it is still in the water without touching it. Equipped with telescopic system with locking slider to reduce their length when not in use. Available in two different sizes with instructions.



Grâce à ces dégorgeoirs et à l'utilisation d'hameçons sans ardillon vous pouvez décrocher un poisson directement dans l'eau sans le toucher. Munis de système télescopique avec blocage à curseur pour réduire leur longueur lorsqu'ils ne sont pas en cours d'utilisation. Disponibles en deux différentes tailles avec notice d'emploi.

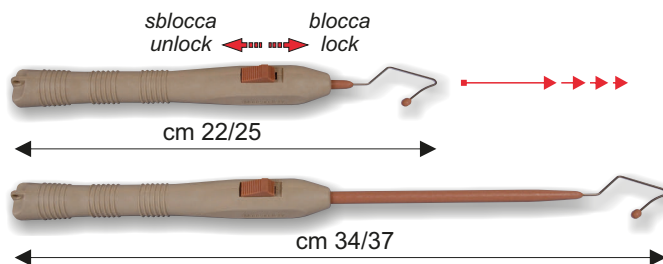

BUSTA DA 1 PEZZO - CONFEZIONE DA 5 BUSTE * 1 PIECE PER BAG - PACK SIZE 5 BAGS

Art.660 **SUPER JAW DISGORGER**

SLAMATORE A PISTOLA - DÉGORGEAIRE PISTOLET



Slamatore a pistola dal design ergonomico ideale per slamare anche in profondità pesci muniti di denti aguzzi. La presa dell'amo è agevole e forte come una pinza metallica. Comodo da trasportare grazie al suo peso estremamente ridotto, solo 60 grammi, e alle sue dimensioni compatte. Munito di impugnatura anti-scivolo è prodotto con materiali resistenti all'ossidazione. Indispensabile nel catch and release per ridurre i tempi di slamatura senza danneggiare la preda.



Pistol grip disgorging with ergonomic design, ideal to unhook sharp-toothed fishes even when very deeply hooked. The grip on the hook is strong as metal pliers. Can be transported easily thanks to its lightweight, only 60 grams, and its pocket-size. Provided with no-slip handle, it is produced with corrosion resistant materials. Indispensable in catch and release to reduce unhooking time without damaging the fish.



Dégorgeoir pistolet avec design ergonomique idéal pour décrocher aussi très en profondeur poissons à dents pointues. Le blocage de l'hameçon est facile et fort comme une pince métallique. Pratique à transporter grâce à son poids réduit, seulement 60 grammes, et sa taille compacte. Muni de poignée antidérapante il est produit avec matériaux anti-corrosion. Indispensable pour le catch and release pour réduire les temps de décrochage sans endommager le poisson.



tenere premuto il grilletto per bloccare l'amo
hold in the trigger to lock the hook
maintenir la gâchette pressée pour bloquer l'hameçon

BUSTA DA 1 PEZZO - CONFEZIONE DA 5 BUSTE
1 PIECE PER BAG - PACK SIZE 5 BAGS

Art.615

SLAMATORI TUBETECH

TUBETECH DISGORGERS - DÉGORGEOIRS TUBETECH

Mis.Size	1	2	3
amo-hook	28 to 16	16 to 8	8 and larger

 *Slamatore di alta qualità con testina sagomata tubolare, studiato per una rapida estrazione dell'amo senza danneggiare la mosca ed il pesce. Prodotto con materiale molto resistente e con impugnatura anatomica in gomma. Ottimo per ogni tipo di pesca è indispensabile quando si pratica il catch and release. Munito di foro per l'aggancio al gilet.*

 *High quality disgorger with shaped tubular head, designed for a quick hook release without damaging fly or fish. Produced with very strong material and with anatomical rubber handle. Fantastic for every kind of fishing it is indispensable for the catch and release. Equipped with eyelet to hang it on a tool holder.*

 *Dégorgeoir d'haute qualité avec tête tubulaire, étudié pour l'extraction rapide de l'hameçon sans endommager la mouche et le poisson. Produit en matériau très résistant et avec poignée anatomique en caoutchouc. Excellent pour tous les types de pêche et indispensable pour le catch and release. Munie de trou d'accroche.*

BUSTA DA 1 PEZZO - CONFEZIONE DA 10 PEZZI
1 PIECE PER BAG - PACK SIZE 10 PIECES

TAPPI IN GOMMA PER CANNE

SOFT PLASTIC POLE CAPS - EMBOUTS STANDARDS POUR CANNES



Nr.Art. 100 pcs	Nr.Art. 10 pcs	DIAMETRO INTERNO - INTERNAL DIAMETER mm
33-1	117	Ø mm 8-9-10-11-12-13-14
33-2	118	Ø mm 15-16-17-18-19-20-21-22
33-3	119	Ø mm 23-24-25-26-27-28-29-30-31-32
33-4	120	Ø mm 33-34-35-36-37-38-39-40-41-42-43-44-45-46-47-48-49



Forma speciale apri-bocca
Special shape to open fish mouth
Forme spéciale ouvre-bouche

Tagli per agevolare l'estrazione dell'amo
These cuts help to release hook
Entailles pour faciliter l'extraction de l'hameçon

Preso rapida del filo
Quick taking of the leader
Prise rapide de la ligne

Tenendo il filo ben teso, portare lo slamatore sull'amo e ruotarlo per agevolare l'estrazione

Hold taut the leader, slide down to the hook and turn the disgorger to unhook

En tenant la ligne tendue, glisser le dégorgeoir sur l'hameçon et tourner pour faciliter l'extraction

Art.430

TAPPI ROUBAISIEENNE

POLE END PROTECTORS

MIS.-SIZES Ø mm	39 - 40 - 41 - 42 - 43 - 44 - 45 - 46 - 47 - 48 - 49 - 50
-----------------	---

 *Tappi in gomma per roubaisienne con tenuta eccezionale. La loro struttura è adeguatamente rinforzata per proteggere il bordo della canna da eventuali urti, cadute o abrasioni sul terreno durante il trasporto o l'azione di pesca.*

 *Pole end protectors with amazing grip. Their structure is reinforced to protect the butt end and eliminating any possibility of splitting or chipping the carbon rim.*

 *Embouts roubaisienne avec tenue exceptionnel. Leur structure est renforcée pour protéger le extrémités de la canne pendant le transport ou l'action de pêche.*





Rimozione agevole del tappo
Easy removal of the cap
Extraction facile du bouchon

BU. DA 2 PZ - CONFEZIONE DA 10 BU.
2 PIECES PER BAG - PACK SIZE 10 BAGS

SALVANELLI SBS TIPO A

MOD. A SBS TIP SAVER

 *Salvanelli in materiale infrangibile trasparente con sistema di bloccaggio rapido "SBS". Modello adatto per canne inglesi telescopiche, canne trota lago e bolognesi. Brevettato.*

 *Tip saver with quick "SBS" locking system. Unbreakable and clear material. Suitable for telescopic match rods, trout rods and bolognese rods. Patented.*

 *Protège pointe, en matériau transparent incassable, avec système de blocage rapide "SBS". Étudié pour cannes anglaises télescopiques, pour cannes pour la pêche en étang et cannes bolognaises. Breveté.*

CHIUSURA SBS
SBS LOCKING SYSTEM
SYSTEME DE BLOCAGE SBS

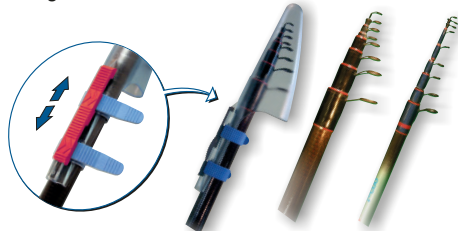

CONFEZIONE DA 10 PEZZI - PACK SIZE 10 PIECES

SALVANELLI SBS TIPO B

MOD. B SBS TIP SAVER



Salvanelli in materiale infrangibile trasparente con sistema di bloccaggio rapido "SBS". Modello adatto per canne bolognesi da metri 3 a metri 9. Brevettato.



Tip saver with quick "SBS" locking system. Clear and unbreakable material. Suitable for Bolognese rods from 3 to 9 metres. Patented.



Protège pointe, en matériau transparent incassable, avec système de blocage rapide "SBS". Étudié pour cannes bolognaïses de 3 à 9 mètres. Breveté.

CHIUSURA SBS
SBS LOCKING SYSTEM
SYSTEME DE BLOCAGE SBS

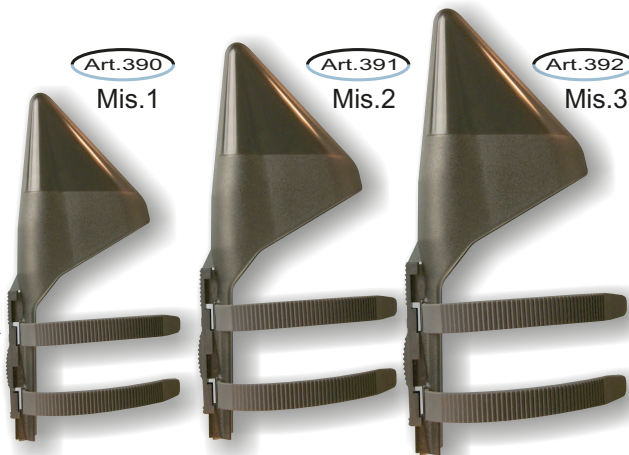
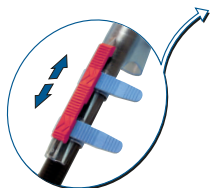

CONFEZIONE DA 10 PEZZI - PACK SIZE 10 PIECES

SALVANELLI SBS TIPO C

MOD. C SBS TIP SAVER



Salvanelli in materiale infrangibile trasparente con sistema di bloccaggio rapido "SBS". Modelli adatti per canne da surfcasting e teleregolabili per trota (Mis.2). Brevettato.



Tip saver with quick "SBS" locking system. Clear and unbreakable material. Suitable for surfcasting rods and adjustable length trout rods (Size 2). Patented.



Protège pointe, en matériau transparent incassable, avec système de blocage rapide "SBS". Étudié pour cannes pour le surfcasting et pour cannes télé réglables pour la truite (Grand modèle). Breveté.

CHIUSURA SBS
SBS LOCKING SYSTEM
SYSTEME DE BLOCAGE SBS

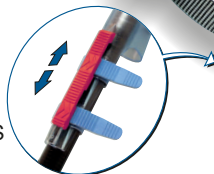

CONFEZIONE DA 10 PEZZI - PACK SIZE 10 PIECES

SALVANELLI SBS TIPO E

MOD. "E" SBS TIP SAVER



Salvanelli in materiale infrangibile trasparente con sistema di bloccaggio rapido "SBS". Modelli con profilo stretto ed allungato, adatti per canne da surfcasting. Brevettato.



Tip saver with quick "SBS" locking system. Clear and unbreakable material. Models with narrow and elongated shape, suitable for surfcasting rods. Patented.



Protège pointe, en matériau transparent incassable, avec système de blocage rapide "SBS". Modèles de forme étroite et allongée, étudiés pour cannes pour le surfcasting. Breveté.

CHIUSURA SBS
SBS LOCKING SYSTEM
SYSTEME DE BLOCAGE SBS

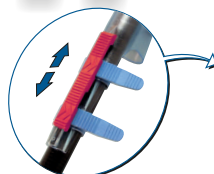

CONFEZIONE DA 10 PEZZI - PACK SIZE 10 PIECES

SALVANELLI BOX

SPECIAL GUIDE PROTECTOR - PROTÈGE POINTE SPECIAL

Art. 125

Misura piccola
Small size

Art. 126

Misura grande
Big size



Ottimo per trasportare le canne bolognesi con lenza pronta all'uso, questo speciale salvanelli accoglie infatti al suo interno la bobina del mulinello e l'avvolgilenza.



Ideal to carry bolognese rods with ready to use rig, this special tip saver can hold the reel spool and the winder.



Idéal pour transporter les cannes bolognaïses avec ligne prête à l'emploi, ce spécial protège pointe peut contenir la bobine du moulinet et le plioir.

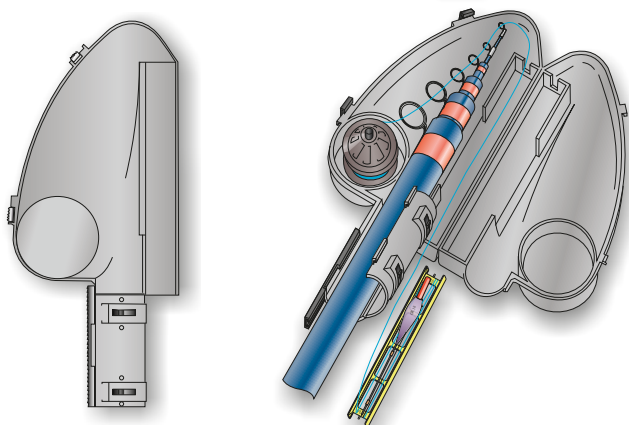

CONFEZIONE DA 1 PEZZO - PACK SIZE 1 PIECE

BOCCOLE PER GUADINI LANDING NET BUSHES - BAGUES POUR ÉPUISSETTE



Art.374	TIPO MA MATERIALE: Alluminio - Aluminium				
Mis. - Sizes	11,5	12,5	14,5	16,0	18,0
	NEW				



Art.364	TIPO MO MATERIALE: Ottone - Brass		
Mis. - Sizes	11,5	12,5	14,5
	NEW		

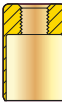

Art.363	TIPO FO MATERIALE: Ottone - Brass				
Mis. - Sizes	13,0	14,5	16,5	18,5	21,5
	NEW				

BUSTA DA 5 PEZZI
PACK SIZE 5 PIECES



Art.606 RASTRELLO RAKE



Rastrello in materiale plastico resistentissimo con vite di metallo universale, si applica al manico del guadino. Utilissimo per togliere dalla superficie dell'acqua erba, alghe ed altro materiale che impedisce l'azione di pesca. Fornito con boccola in ottone filettata che permette l'utilizzo del rastrello con una vecchia canna. Dim. mm 120X80.



Strong plastic rake with universal metal thread, it fits on landing net handle. Useful to remove from the water weed and other materials that prevent fishing. Supplied with brass female thread to make an handle from an old rod. Size mm 120 x 80.



Râteau en plastique très solide avec vis universelle en métal, il s'applique à la manche d'épuisette. Il est très utile pour enlever herbe, algues et autre matériel qui empêche l'action de pêche. Fourni avec bague de fixation en laiton pour utiliser une vieille canne comme poignée. Dim. mm 120X80.



BUSTA DA 1 PEZZO - CONFEZIONE DA 5 BUSTE
1 PIECE PER BAG - PACK SIZE 5 BAGS

SONDE ELITE PLUMMETS

Nr.Art. 10 pcs	Nr.Art. 2 pcs	PESO - WEIGHT GR
236	236S	GR 3 - 5 - 8
236-1	236-1S	GR 10 - 15 - 20 - 25 - 30



Sonde speciali con dispositivo a pulsante che agisce direttamente sull'amo senza danneggiare il filo, proteggendone la punta da eventuali appigli. Prodotte in ottone con parti fosforescenti per la pesca di notte. Forma idrodinamica. Adatte anche per ami piccolissimi.



Special plummets with push-button device that grips directly on the hook without damaging the line, protecting the hook point from entanglement. Made of brass with plastic phosphorescent parts for night fishing. Hydrodynamic shape. Suitable also for very small hooks.



Sonde à ressort pratique pour mesurer le fond. Grâce à son ergonomie particulière il n'ya plus d'accrochage, même dans les herbiers les plus épais. Munie d'un bouton poussoir elle est très simple d'utilisation, sa tête en plastique phosphorescent, pour la pêche de nuit, protège parfaitement l'hameçon même le plus petit.



GR 3 5 8



GR 10 15 20 25 30



SONDA LIGHT LIGHT TYPE PLUMMET



Sonda speciale a pulsante. Il suo peso ridotto consente di sondare con estrema precisione a grande distanza.



Special plummet with push-button device. Its light weight allows to find the depth with accuracy at long distance.



De conception identique aux sondes Elite mais plus légère. Extrême précision à grande distance. Idéal pour la pêche à l'anglaise.

Nr.Art. 10 pcs	Nr.Art. 2 pcs	PESO - WEIGHT GR
236L	236LS	GR 1 LIGHT



STRISCI

ANTI TANGLE BOMBS - BOMBETTES

Nr.Art. 20 pcs	Nr.Art. 2 pcs	PESO - WEIGHT GR
258	505	MINI STRISCIO GR 2-3-4-5-6-7-8
258-1	506	MAXI STRISCIO GR 10-12-15-20-25



PESI INTERCAMBIABILI

INTERCHANGEABLE WEIGHTS

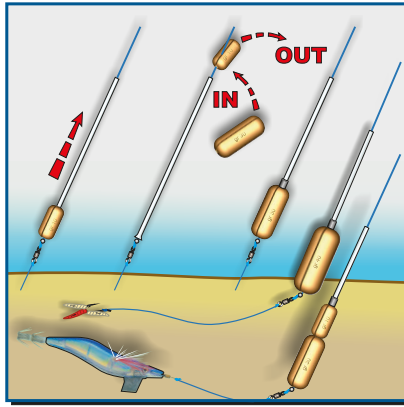

Pesi intercambiabili ottimi per ogni tipo di pesca. Il tubetto anti-incaglio può alloggiare anche due pesi insieme per raddoppiare la grammatura.



Interchangeable weights for every kind of fishing. The anti-tangle tube can hold two weights together to double the grams.



Poids interchangeables ideaux pour tous les types de pêche. Le petit tube anti-emmêlage peut tenir deux poids ensemble pour doubler le grammage.

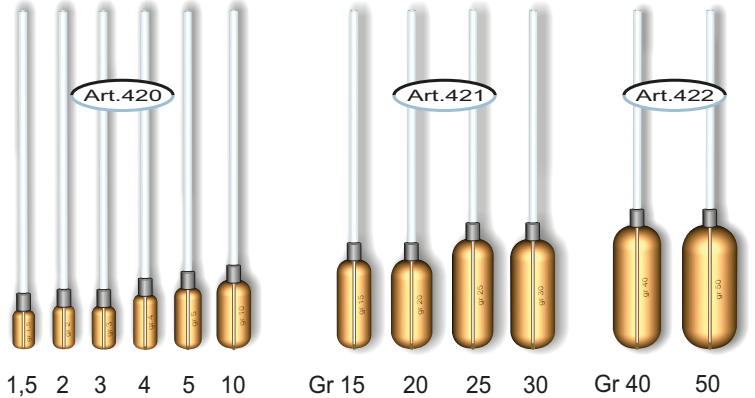

BUSTA DA 2 PEZZI - CONFEZIONE DA 10 BUSTE
2 PIECES PER BAG - PACK SIZE 10 BAGS

FERMAGALLEGGIANTI METALLO

METAL FLOAT ATTACHMENTS - FIXE FLOTTEURS EN ACIER INOX

Art.27

Mis. Piccola
Small size



guaina pvc
pvc tube

Art.27-1

Mis. Grande
Big size

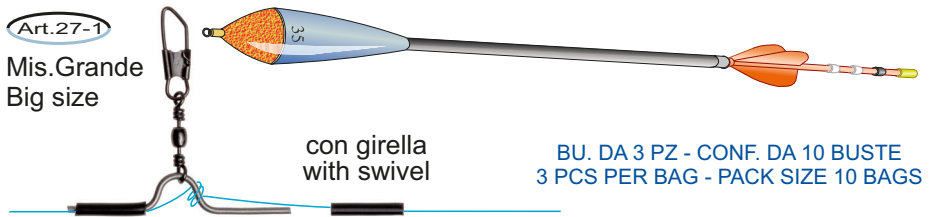

con girella
with swivel

BU. DA 3 PZ - CONF. DA 10 BUSTE
3 PCS PER BAG - PACK SIZE 10 BAGS

FERMAGALLEGGIANTI IN SILICONE

SILICONE FLOAT ATTACHMENTS - FIXE FLOTTEURS EN SILICONE

Art.25

FERMAGALLEGGIANTE STANDARD
Standard float attachment

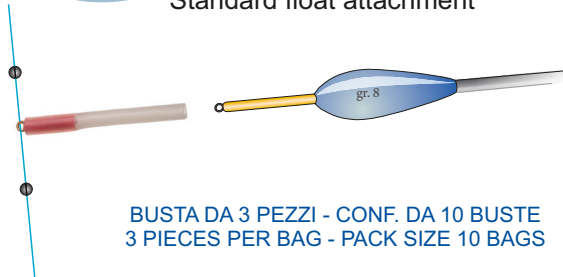

BUSTA DA 3 PEZZI - CONF. DA 10 BUSTE
3 PIECES PER BAG - PACK SIZE 10 BAGS

Art.26

FERMAGALLEGGIANTE CON GIRELLA
Swivel float attachment

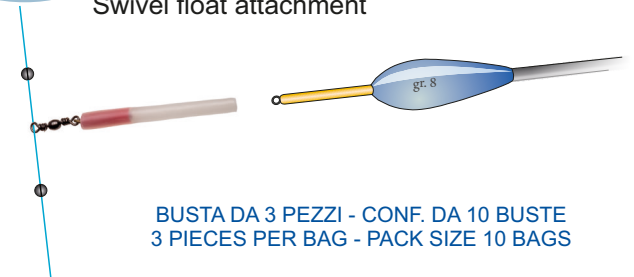

BUSTA DA 3 PEZZI - CONF. DA 10 BUSTE
3 PIECES PER BAG - PACK SIZE 10 BAGS

Art.26-1

ATTACCO PER GALLEGGIANTI PIOMBATI

FLOAT ATTACHMENTS FOR HEAVY WAGGLERS



Fermagalleggianti in plastica del tipo fisso per galleggianti pesanti. Munito di anello in gomma per l'assorbimento degli shock a cui il filo è sottoposto. Assicura una eccellente tenuta.



Special plastic float-line connector for heavy wagglers. Supplied with rubber shock absorbing ring.



Fixe flotteur en plastique pour "wagglers" lourds. Muni de anneau en caoutchouc pour absorber les chocs du fil. Assure une excellent résistance.

BUSTA DA 3 PEZZI - CONF. DA 10 BUSTE
3 PIECES PER BAG - PACK SIZE 10 BAGS

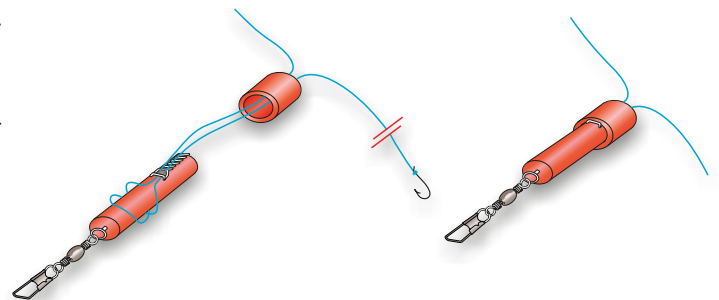

FERMAGALLEGGIANTI STOP

STOP FLOAT ATTACHMENTS



Fermagalleggianti del tipo fisso con girella e moschettone. Muniti di speciali tubetti di bloccaggio che assicurano una eccellente tenuta della posizione.



Float-line connector with swivel and snap for wagglers. Supplied with special locking tubes.



Fixe flotteur pour la pêche en fixe avec émerillon et agrafe pour un blocage parfait sur le fil. Muni de spéciaux gaines de fixation.

BUSTA DA 3 PZ. - CONF. DA 10 BU.
3 PCS PER BAG - PACK SIZE 10 BAGS

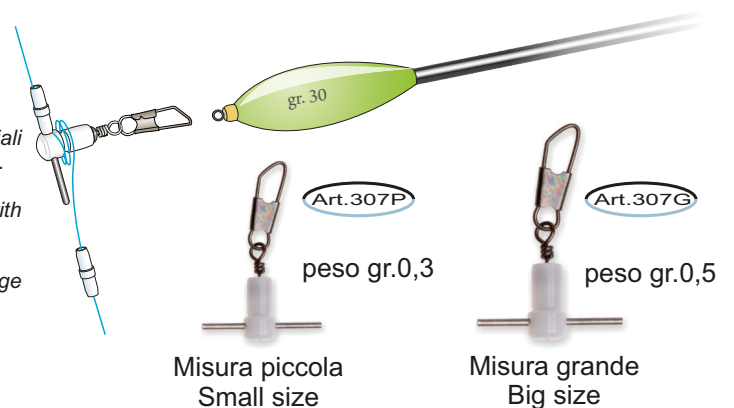

Misura piccola
Small size

Misura grande
Big size

FERMAGALLEGGIANTI MAXI

MAXI FLOAT ATTACHMENTS



Fermagalleggianti del tipo fisso con girella e moschettone. Muniti di speciali tubetti di bloccaggio che assicurano una eccellente tenuta della posizione. Massima libertà di rotazione del galleggiante.



Float-line connector with swivel and snap for wagglers. Supplied with special locking tubes. Rotating freedom reduces any possibility of entanglement.



Fixe flotteur pour la pêche en fixe avec émerillon et agrafe pour un blocage parfait sur le fil. Muni de spéciaux gaines de fixation. Maximum liberté de rotation du flotteur.

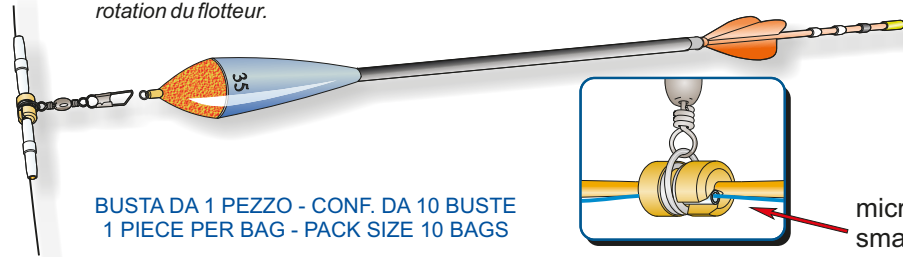

BUSTA DA 1 PEZZO - CONF. DA 10 BUSTE
1 PIECE PER BAG - PACK SIZE 10 BAGS

Art.255-1

Misura piccola
Small size



Art.255

Misura grande
Big size

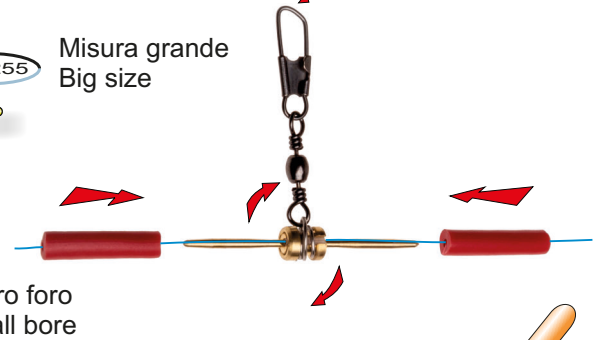

micro foro
small bore

FERMAGALLEGGIANTI SCORREVOLI

SLIDER FLOAT ATTACHMENTS



Fermagalleggianti per il montaggio scorrevole con perlina in metallo levigato per lanci sicuri senza problemi.



Attachments for float, to be used for smooth running. Equipped with a rotating smooth metal bead for sure casting without problems.



Fixe flotteur à utiliser pour le montage coulissant. Équipé d'une perle roulant en métal lèvigé pour des lancers assurés et sans problème.

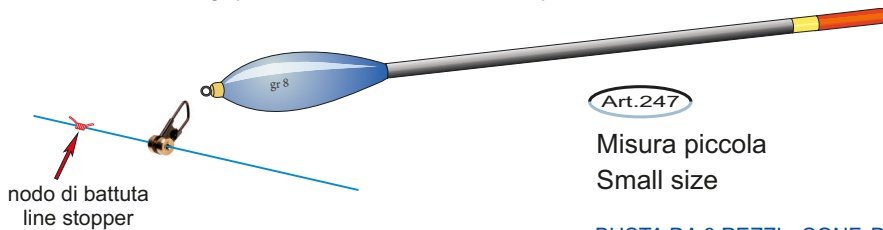

nodo di battuta
line stopper

Art.247

Misura piccola
Small size

Art.247-1

Misura grande
Big size

elastico di battuta
elastic stopper

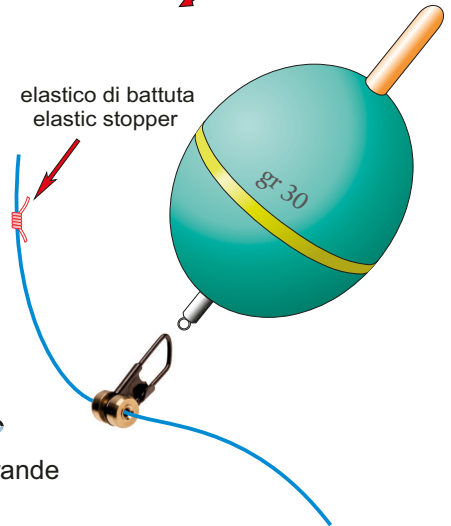

BUSTA DA 3 PEZZI - CONF. DA 10 BUSTE - 3 PIECES PER BAG - PACK SIZE 10 BAGS

Art.360

FERMAGALLEGGIANTI SCORREVOLI MATCH

"MATCH" FLOAT ATTACHMENTS



Fermagalleggianti per il montaggio scorrevole con perlina in materiale autolubrificante per lanci sicuri senza problemi.



Attachments for float, to be used for smooth running. Equipped with a self lubricating rotating smooth bead for sure casting without problems.



Fixe flotteur à utiliser pour le montage coulissant. Équipé d'une perle roulant lèvigé auto lubrifiant pour des lancers assurés et sans problème.

Art.306

FIONDA STANDARD STANDARD CATAPULT



Fionda in plastica con elastici tubolari e bicchierino con rinforzo interno.



Standard plastic catapult with tubular elastic and pouch with plastic support.



Fronde en plastique munie d'un élastique tubulaire, avec un godet à renfort intérieur.

Mis.-Size 0

real size
scala 1:1



BUSTA DA 2 PEZZI - CONF. DA 10 BUSTE
2 PIECES PER BAG - PACK SIZE 10 BAGS

CONFEZIONE DA 10 PEZZI
PACK SIZE 10 PIECES



FIONDE TWIN COLOUR TWIN COLOUR CATAPULTS

Art.311-1

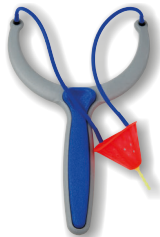

Fionda studiata per la pesca a galla a corta distanza, permette la massima precisione utilizzando la minima quantità di esche.



Catapult designed for surface fishing at short distances. Allows maximum precision with a minimum quantity of bait.



Fronde conçue pour la pêche à ligne flottante de courte distance, elle permet une précision maximum en utilisant une quantité minimum d'amorce.

Art.311-2



Fionda con elastici di media potenza e bicchierino piccolo con supporto plastico interno.



Catapult with medium power elastics and small size pouch with plastic support.



Fronde avec élastiques de force moyenne et godet petit modèle à renfort intérieur.

Art.311-3



Fionda con elastici di buona potenza e bicchierino medio con supporto plastico interno.



Catapult with powerful elastics and medium size pouch with plastic support.



Fronde avec élastiques forts et godet moyen modèle à renfort intérieur.

ELASTICI DI RICAMBIO
OMAGGIO - FREE
SPARE ELASTICS

BUSTA DA 1 PEZZO - CONF. DA 10 BUSTE - 1 PIECE PER BAG - PACK SIZE 10 BAGS

FIONDE TWIN COLOUR GRANDI TWIN COLOUR CATAPULTS BIG SIZES



Fionda grande con elastici di buona potenza e bicchierino grande con supporto plastico interno.



Catapult with big frame and powerful elastics. Big size perforated pvc pouch with inner plastic support.



Fronde avec fourche de grande taille avec élastiques puissants. Godet grand modèle à renfort intérieur.



Art.312



Fionda grande con elastici di ottima potenza e bicchierino per pastura con supporto plastico sagomato interno.



Catapult with big frame and super powerful elastics. Groundbait perforated pvc pouch with inner plastic support.



Fronde avec fourche grande taille avec élastiques très puissants. Godet pour amorce à renfort intérieur.



Art.313

BUSTA DA 1 PEZZO - CONFEZIONE DA 10 BUSTE
1 PIECE PER BAG - PACK SIZE 10 BAGS

FIONDE X SERIES X SERIES CATAPULTS



Fionda studiata per la pesca a galla a corta distanza, permette la massima precisione utilizzando la minima quantità di esche.



Catapult designed for surface fishing at short distances. Allows maximum precision with a minimum quantity of bait.



Fronde conçue pour la pêche à ligne flottante de courte distance, elle permet une précision maximum en utilisant une quantité minimum d'amorce.



Fionda studiata per lanci di precisione a media distanza.



Catapult designed for precise casting at medium distance.



Fronde conçue pour lancer avec précision à distance moyenne.



Fionda con forcella resistentissima studiata per lanci di precisione a lunga e media distanza. Nuovo bicchierino con pallina anti-scivolo.



Catapult designed for precise casting at long and medium distance. Very strong frame and special soft grip pouch.



Fronde en matériau encassable conçue pour lancer avec précision à distance moyenne et grande. Poche munie d'une petite boule pour une utilisation très pratique.



Art.405

Short distance



Art.407

Medium distance



Art.409

Medium long distance

CONFEZIONE DA 10 PEZZI
PACK SIZE 10 PIECES



FIONDE PRO MATCH PRO MATCH CATAPULTS



Fionde da gara con impugnatura anatomica soft touch, permettono la massima precisione utilizzando la minima quantità di esche. Munite di boccole in PTFE salva elastico. Fornite in 3 diverse misure con grandezza della forcella rapportata alla potenza dell'elastico.



Competition catapults with soft touch handle. Allow maximum precision with a minimum quantity of bait. Equipped with elastic saving PTFE bushes. Available in 3 different sizes.



Frondes de compétition avec poignée anatomique soft touch, elles permettent une précision maximum en utilisant une quantité minimum d'amorce. Trois mesures différentes munies de tulipes en ptfé protège élastiques.

Mis.-Size	elastici - elastics
1 (Art.356)	Ø ext mm 2,8
2 (Art.357)	Ø ext mm 3,8
3 (Art.358)	Ø ext mm 5,0



Art.356



Art.357

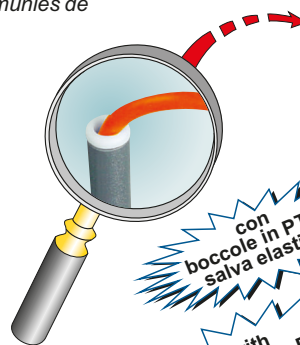

con boccole in PTFE salva elastico
with elastic saving PTFE bushes



Art.358

CONFEZIONE DA 10 PEZZI - PACK SIZE 10 PIECES

FIONDE TWIN COLOUR Alluminio ALUMINIUM CATAPULTS



Forcelle in alluminio con impugnatura in plastica anatomica infrangibile. Munite di elastici di grande potenza sono ottime per il lancio di pastura a grandissima distanza.



Aluminium catapults with unbreakable anatomic plastic handle. Designed to deliver a large quantity of bait at long distance. Supplied with ultra powerful elastics.



Fronde en aluminium avec poignée anatomique et élastiques très puissants. Idéales pour les lancers d'amorces et des bouillettes à grande distance.

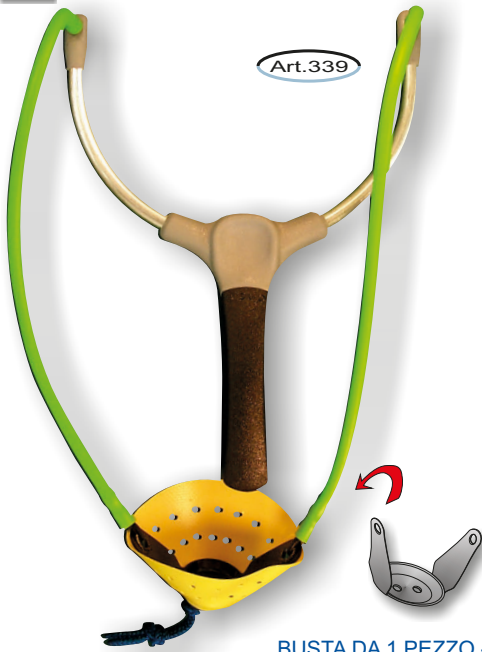

Art.339



Art.339-1



Art.339-2

BUSTA DA 1 PEZZO - CONFEZIONE DA 10 PZ.
1 PER BAG - PACK SIZE 10 BAGS

FIONDE MAXI

MAXI CATAPULTS



Forcelle in alluminio con impugnatura in plastica anatomica e bicchierino in gomma morbida per pastura. Munite di elastici di notevole potenza sono state studiate per il lancio di pastura a grandissima distanza.



Aluminium catapults with anatomic plastic handle and soft rubber groundbait pouch. Designed to deliver a large quantity of bait at long distance. Supplied with super powerful elastics.



Fronde en aluminium avec poignée anatomique et élastiques extra puissants. Godet grand modèle en caoutchouc, idéal pour les lancers d'amorces et des bouillettes à très grande distance.

BUSTA DA 1 PEZZO - CONFEZIONE DA 10 PEZZI
1 PER BAG - PACK SIZE 10 BAGS



Art.340

FIONDA MAXI 1



Art.341

FIONDA MAXI 2

Art.690

FIONDA MAXI 3

MAXI 3 CATAPULT



Fionda in alluminio con impugnatura anatomica in ABS. Essa è munita di elastici di notevole potenza e bicchierino in gomma di forma conica di grande capacità. Studiata per una pasturazione precisa a grande distanza di boilies, pellets, particles e molto altro.



Aluminium catapult with anatomic ABS handle. Equipped with super powerful elastics and with a conical rubber pouch of large capacity. Designed for an accurate delivery at long distances of boilies, pellets, particles, etc.



Fronde en aluminium avec poignée anatomique en ABS. Elle est munie de élastiques très puissants et godet en caoutchouc de forme conique de grande capacité. Conçue pour un amorçage précis à grande distance de boilies, pellets, particles, etc.

BUSTA DA 1 PZ. - CONF. DA 10 PEZZI * 1 PER BAG - PACK SIZE 10 BAGS

Art.383

BLOCCA ELASTICI PER FIONDE

SPARE CONNECTORS FOR CATAPULTS - CONNECTEUR ELASTIQUE-FRONDE



TIPO "A"

per art. - for item
306



TIPO "B"

per art. - for item
311-1



TIPO "C"

per art. - for item
311-2 311-3



TIPO "D"

per art. - for item
312 313



TIPO "E"

per art. - for item
339 340 341 690



TIPO "F"

per art. - for item
405



TIPO "G"

per art. - for item
407 409

fornito completo di fascetta
supplied with cable ties
livré avec colliers

BUSTA DA 4 PEZZI - CONF. DA 10 BUSTE
4 PIECES PER BAG - PACK SIZE 10 BAGS

Art.382

BLOCCA BICCHIERINO PER FIONDE

SPARE CONNECTOR FOR CATAPULT POUCHES
 CONNECTEUR DE RECHANGE POUR GODET
 fornito completo di fascetta
 supplied with cable ties
 livré avec colliers

BUSTA DA 4 PEZZI - CONF. DA 10 BUSTE
 4 PIECES PER BAG - PACK SIZE 10 BAGS



BICCHIERINI PER FIONDE CATAPULT POUCHES - GODETS POUR FRONDES

Art.291-2

Micro size

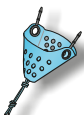

Art.291

Piccolo
Small size

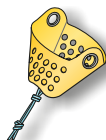

Art.291

Medio
Medium size

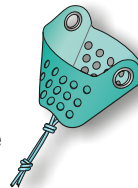

Art.291

Grande
Large size

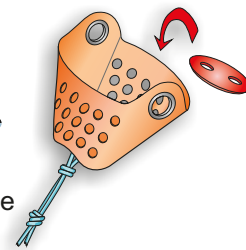

forniti con 2 blocca elastici e fascette
 supplied with 2 connectors and cable ties

CONFEZIONE DA 10 PEZZI - PACK SIZE 10 PIECES

BICCHIERINI PER PASTURA E BOILIES

GROUND BAIT-BOILIES POUCHES - GODETS POUR AMORCE ET BOUILLETES

Art.291-1

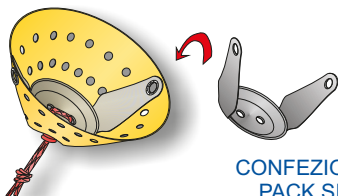

Art.291-3

TIPO A

CONFEZIONE DA 10 PEZZI
 PACK SIZE 10 PIECES

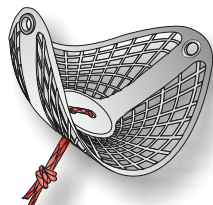

Art.291-4

TIPO B



NEW

Art.246

BICCHIERINO MAXI MAXI POUCH



Bicchierini in gomma morbida di alta qualità, sono disponibili in tre diverse misure.



High quality soft rubber spare pouch. Available in 3 different sizes.



Godets en caoutchouc souple de haute qualité. Disponibles en 3 tailles.

BUSTA DA 1 PEZZO - CONFEZIONE DA 10 BUSTE
 1 PER BAG - PACK SIZE 10 BAGS

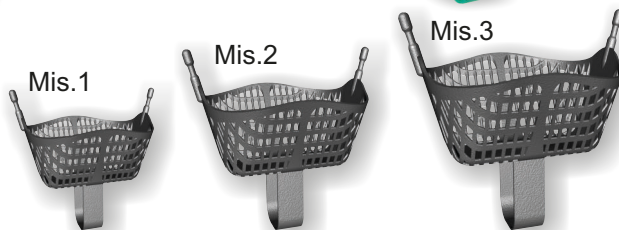

BICCHIERINI X SERIES E PRO MATCH X SERIES AND PRO MATCH POUCHES



Bicchierini in materiale morbido con presa antiscivolo. Adatti per fionde Xseries e ProMatch. Forniti con 2 fascette blocca-elastico.



Soft pouches with antiskid grip. Suitable for X Series and Pro Match catapults. Supplied with 2 cable ties.



Godets souples avec poignée antiglisse. Pour frondes Xseries et ProMatch. Livrés avec 2 colliers.

BUSTA DA 1 PEZZO - CONFEZIONE DA 10 BUSTE
 1 PER BAG - PACK SIZE 10 BAGS

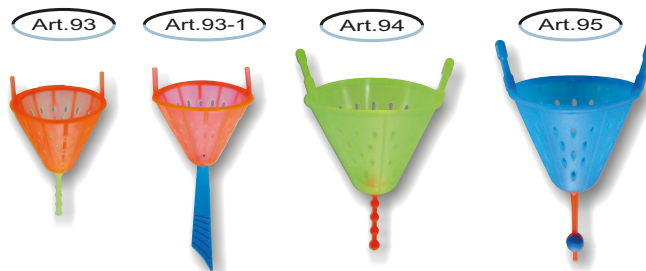

Art.691

BICCHIERINO MAXI CONE MAXI CONE POUCH



Bicchierino in gomma di grande capacità. Studiato per una pasturazione precisa a grande distanza di boilies, pellets, particles e molto altro. La sua forma conica evita la dispersione di pastura durante il lancio.



Large capacity rubber pouch. Designed for an accurate delivery at long distances of boilies, pellets, particles, etc. Its conical shape avoids the bait dispersion during the cast.



Godet en caoutchouc de grande capacité. Conçu pour un amorçage précis à grande distance de boilies, pellets, particles, etc. Sa forme conique empêche la dispersion d'amorce pendant le lancer.

BUSTA DA 1 PZ. - CONF. DA 5 PEZZI * 1 PER BAG - PACK SIZE 5 BAGS



ELASTICI DI RICAMBIO PER FIONDE

REPLACEMENT ELASTICS FOR CATAPULTS
 ÉLASTIQUES DE RECHANGE POUR FRONDES



fornito con 4 fascette per busta
 supplied with 4 cable ties per bag
 livré avec 4 colliers pour sachet

Nr.Art. bag cm 60	DIAMETRI mm - DIAMETER mm	Nr.Art. bulk-a metri
290-0	● Pieno - Solid elastic Ø 2,0	317
290-1	● Pieno - Solid elastic Ø 3,0	318
290-2	● Pieno - Solid elastic Ø 4,0	319
290-3	● Pieno - Solid elastic Ø 5,0	320
290-4	○ Tubolare - Hollow elastic Ø ext.2,8 -int.1,2	322
290-5	○ Tubolare - Hollow elastic Ø ext.3,8 -int.1,8	323
290-6	○ Tubolare - Hollow elastic Ø ext.5,0 -int.2,5	324
290-7	○ Tubolare - Hollow elastic Ø ext.6,0 -int.3,0	325
290-8	○ Tubolare - Hollow elastic Ø ext.7,0 -int.3,0	326
290-9	○ Tubolare - Hollow elastic Ø ext.8,0 -int.3,0	327

ELASTICI DI RICAMBIO PER FIONDE A METRI

REPLACEMENT ELASTICS FOR CATAPULTS IN BULK
 ÉLASTIQUES POUR FRONDES À MÈTRES



BUSTA DA 60 CM - CONFEZIONE DA 10 BUSTE
 60 CM PER BAG - PACK SIZE 10 BAGS

CONFEZIONATO IN BUSTE DA 100 METRI
 IN POLIBAG FOR 100 METRES

Art.237 PERLINE CON FORO

BORED BEADS - PERLES

CONFEZIONE DA 10 SCATOLINE
PACK SIZE 10 BOXES



Nr.Art.	Ø ESTERNO - Ø EXT. mm
237	Misure assortite - Miscellaneous sizes
237-20	Misura Ø 2 mm - Size Ø 2
237-30	Misura Ø 3 mm - Size Ø 3
237-40	Misura Ø 4 mm - Size Ø 4
237-50	Misura Ø 5 mm - Size Ø 5

PERLINE ELITE ELITE BEADS

Art.285 NERO/BIANCO/TRASPARENTE - BLACK/WHITE/CLEAR

Art.285tra TRASPARENTE - ONLY CLEAR

Perline sferiche di alta qualità. Adatte per moltissimi usi e per ogni tipo di pesca. Prodotte in sette differenti misure dalla microscopica 0,8 mm fino a 5 mm.

High quality round beads. Suitable for many uses and for every kind of fishing. Available in 7 different sizes.

Perles sphériques de haute qualité. Pour montages divers, en dérivation même ultra fins, pour arrêter le flotteur etc.

BUSTA DA 80 PERLINE - CONF. DA 10 BUSTE
80 BEADS PER BAG - PACK SIZE 10 BAGS

Colori - Colours:
Nero - Black
Bianco - White
Trasparente - Clear



Ø ext. 0,8 1,2 1,6 2,2 3 4 5

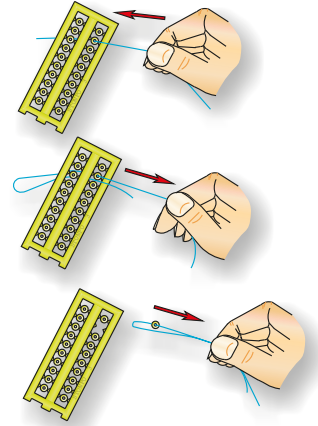

**Art.285-1 PERLINE ELITE FOTOLUMINESCENTI
PHOSPHORESCENT ELITE BEADS**

Perline fotoluminescenti sferiche di alta qualità. Adatte per moltissimi usi e per ogni tipo di pesca. Prodotte in sette differenti misure dalla microscopica 0,8 mm fino a 5 mm.

High quality phosphorescent round beads. Suitable for many uses and for every kind of fishing. Available in 8 different sizes.

Perles sphériques phosphorescentes de haute qualité. Pour montages divers, en dérivation même ultra fins, pour arrêter le flotteur etc.

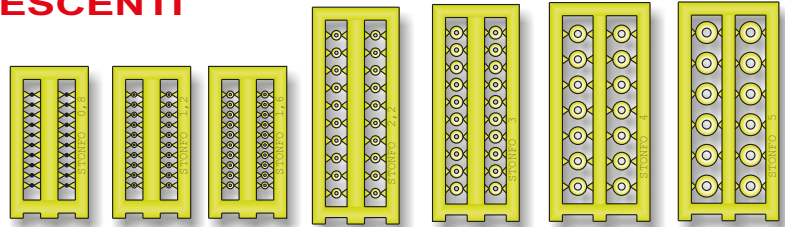

Ø ext. 0,8 1,2 1,6 2,2 3 4 5

BUSTA DA 80 PERLINE - CONF. DA 10 BUSTE
80 BEADS PER BAG - PACK SIZE 10 BAGS

**Art.253 PERLINE ARCOBALENO
COLORED ROUND BEADS - PERLES MULTICOLORE**

Perline sferiche di alta qualità. Adatte per moltissimi usi e per ogni tipo di pesca. La loro disposizione su placchetta ne agevola l'impiego.

High quality round beads. Suitable for many uses and for every kind of fishing. Beads are connected to a frame. Simply remove from the frame to use.

Perles sphériques de haute qualité. Pour montages divers, en dérivation même ultra fins, pour arrêter le flotteur etc.

Mis	Ø 0,8
sizes	Ø 1,2
Ø	Ø 1,6
mm	Ø 2,2

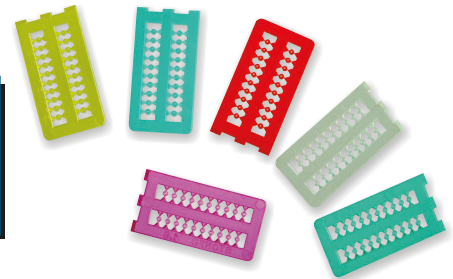

BUSTA DA 120 PERLINE - CONFEZIONE DA 10 BUSTE * 120 BEADS PER BAG - PACK SIZE 10 BAGS

**Art.436 PERLE TONDE IN POLICARBONATO Ø 6 MM
POLYCARBONATE BEADS - PERLES EN POLYCARBONATE**

Perle prodotte in resistentissimo policarbonato adatte per gli usi più gravosi. Ideali per il montaggio di palamiti e bolentino di profondità. Dimensioni Ø est. mm 6 - Ø foro mm 1,8.

Beads made of strong polycarbonate are useful for long line and deep fishing. Dimensions Ø ext. mm 6 - Ø bore mm 1,8.

Perles en polycarbonate très résistant idéales pour les palangres et la pêche de profondeur. Dimensions Ø ext. mm 6 - Ø trou mm 1,8.

BUSTA DA 120 PERLINE - CONFEZIONE DA 10 BUSTE * 120 BEADS PER BAG - PACK SIZE 10 BAGS



PERLE BARILOTTO HARD BEADS - PERLES EN PLASTIQUE DURE

Art.158
Ø mm 5x8
Foro-Bore Ø mm 1,2



Art.159
Ø mm 8x12
Foro-Bore Ø mm 1,8



Art.160
Ø mm 11x14
Foro-Bore Ø mm 2,3



BUSTA DA 15 PZ. - CONF. DA 10 BUSTE * 15 PIECES PER BAG - PACK SIZE 10 BAGS

PERLE BARILOTTO FOTOLUMINESCENTI

LUMINOUS HARD BEADS - PERLES PHOTOLUMINESCENTES



Art.161

Ø mm 5x8
Foro-Bore Ø mm 1,2



Art.162

Ø mm 8x12
Foro-Bore Ø mm 1,8



Art.163

Ø mm 11x14
Foro-Bore Ø mm 2,3

BUSTA DA 15 PZ. - CONF.DA 10 BUSTE * 15 PIECES PER BAG - PACK SIZE 10 BAGS

PERLE BARILOTTO 1000 pz.

HARD BEADS
PERLES EN PLASTIQUE DURE

LUMINOUS HARD BEADS
PERLES PHOTOLUMINESCENTES

Nr.Art.	DIMENSION MM
164	Ø mm 5x8 Foro-Bore Ø mm 1,2
165	Ø mm 8x12 Foro-Bore Ø mm 1,8
166	Ø mm 11x14 Foro-Bore Ø mm 2,3
167	LUMINOUS Ø mm 5x8 int.Ø mm 1,2
168	LUMINOUS Ø mm 8x12 int.Ø mm 1,8
169	LUMINOUS Ø mm 11x14 int.Ø mm 2,3

Colori : arancio-orange
giallo - yellow



CONFEZIONE DA 1000 PZ. - PACK SIZE 1000 PIECES

PERLE TONDE FORO GRANDE

BIG BORE HARD BEADS - PERLES PLASTIQUE DURE AVEC GROS TROU



Art.215

Ø mm 12 (15 Pcs)
Foro-Bore Ø mm 3,5

Art.217

Ø mm 14 (15 Pcs)
Foro-Bore Ø mm 4,5

Art.216

Ø mm 12 (15 Pcs)
Photoluminescent
Foro-Bore Ø mm 3,5

Art.218

Ø mm 14 (15 Pcs)
Photoluminescent
Foro-Bore Ø mm 4,5

Art.211

Ø mm 12 (1000 Pcs)
Foro-Bore Ø mm 3,5

Art.213

Ø mm 14 (1000 Pcs)
Foro-Bore Ø mm 4,5

Colori :arancio-orange
giallo - yellow

Art.212

Ø mm 12 (1000 Pcs)
Photoluminescent
Foro-Bore Ø mm 3,5

Art.214

Ø mm 14 (1000 Pcs)
Photoluminescent
Foro-Bore Ø mm 4,5



CONF. DA 10 BUSTE - PACK SIZE 10 BAGS

Art.316

PERLINE TONDE MORBIDE

ROUND RUBBER BEADS - PERLES CAOUTCHOUC



Perline sferiche in gomma morbida. Disponibili in 3 misure.

Round rubber beads. Available in 3 sizes.

Perles sphériques en caoutchouc. Disponibles en 3 tailles.



Mis sizes	Ø
Mis.00	3,0
Mis.0	4,0
Mis.1	5,0

BUSTA DA 56 PZ.-CONF.DA 10 BUSTE
56 PIECES PER BAG-PACK SIZE 10 BAGS

Art.155

PERLINE SALVANODO

SHOCK ABSORBER RUBBER BEADS



Perline salvanodo in gomma morbida.

Shock absorbing rubber beads.

Perles en caoutchouc protège nœuds.

BUSTA DA 15 PEZZI.-CONF. DA 10 BUSTE
15 PIECES PER BAG-PACK SIZE 10 BAGS



Nr.Art.	SIZE	DIM.
155	Mis.00	Ø 3,0mm
155	Mis.0	Ø 4,0mm
155	Mis.1	Ø 5,0mm
155	Mis.2	Ø 8,0mm
155G	Mis.3	Ø 11,0mm

Art.155F

PERLINE LUMINOSE IN GOMMA

LUMINOUS SOFT BEADS



Perline salvanodo luminose in gomma.

Shock absorbing luminous soft beads.

Perles lumineuses souples protège nœuds.

BUSTA DA 15 PEZZI.-CONF. DA 10 BUSTE
15 PIECES PER BAG-PACK SIZE 10 BAGS





Nr.Art.	SIZE	DIM.
155F	Mis.00	Ø 3,0mm
155F	Mis.0	Ø 4,0mm
155F	Mis.1	Ø 5,0mm
155F	Mis.2	Ø 8,0mm
155FG	Mis.3	Ø 11,0mm

ATTRACTOR BEADS

Art.545	ATTRACTOR BEADS				
Colori Colours	Giallo Yellow	Arancio Orange	Rosso Red	Verde Green	Fucsia Fuchsia
Mis Sizes	Ø mm 3,0 -4,0				

BUSTA DA 40 PERLINE - CONFEZIONE DA 10 BUSTE
40 BEADS PER BAG - PACK SIZE 10 BAGS

 Perline in gomma dai colori fluorescenti. Montate direttamente sull'esca artificiale oppure sul filo vicino all'amo rendono più attrattiva la montatura aumentando così le probabilità di cattura. Adatte sia per le acque interne che per la pesca in mare. Disponibili in 5 brillanti colori e 5 diverse misure.

 Fluo-colour rubber beads. Place one of them over the hook eye or add more beads on the rig close to the hook, for better fish attraction. Suitable for all types of fishing. Available in 5 bright colours and 5 different sizes.

 Perles en caoutchouc des couleurs fluorescentes. Elles peuvent être disposées sur les empiles devant l'hameçon ou sur l'hameçon même en rendant plus attractif le montage. Indiquées pour tous les types de pêche. Disponibles en 5 brillantes couleurs et 5 différentes tailles.

Art.546	ATTRACTOR BEADS MAXI				
Colori Colours	Giallo Yellow	Arancio Orange	Rosso Red	Verde Green	Fucsia Fuchsia
Mis Sizes	Ø mm 5,0 -6,0 -7,0				

BUSTA DA 20 PERLINE - CONFEZIONE DA 10 BUSTE
20 BEADS PER BAG - PACK SIZE 10 BAGS

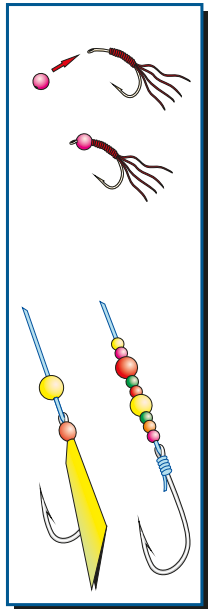

Art.521 PERLE MAX MORBIDE MAX RUBBER BEADS

 Perline sferiche in gomma morbida.

 Soft round rubber beads.

 Perles sphériques en caoutchouc.

BUSTA DA 20 PZ-CONF. DA 10 BUSTE
20 PCS PER BAG-PACK SIZE 10 BAGS

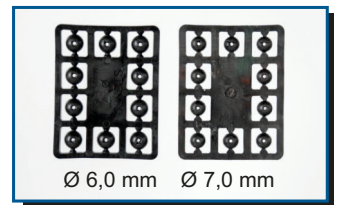

Art.522 PERLE MAX LUMI MORBIDE PHOTOLUMINESCENT MAX RUBBER BEADS

 Perle sferiche fotoluminescenti in gomma morbida.

 Photoluminescent soft round rubber beads.

 Perles sphériques photoluminescentes en caoutchouc.

BUSTA DA 20 PZ-CONF. DA 10 BUSTE
20 PCS PER BAG-PACK SIZE 10 BAGS

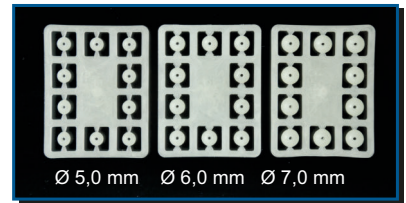

Art.342 BATTIPALO STICK DRIVER

 Boccola in plastica infrangibile per facilitare l'inserimento di paletti nel terreno.

 Bank stick basher, to insert the stick in the hard or dry ground.

 Guide-enfonce pique, pour faciliter l'insertion du pique dans le sol.



BUSTA DA 1 PEZZO - CONF. DA 10 BUSTE
1 PIECE PER BAG - PACK SIZE 10 BAGS



APPOGGIA CANNE

Art.350

APPOGGIACANNA TIPO F
ROD REST TYPE F
SUPPORT CANNE MODÈLE F AVANT

BUSTA DA 1 PEZZO - CONF. DA 10 BUSTE
1 PIECE PER BAG - PACK SIZE 10 BAGS



Art.351

APPOGGIACANNA TIPO B
ROD REST TYPE B
SUPPORT CANNE MODÈLE ARRIÈRE

BUSTA DA 1 PEZZO - CONF. DA 10 BUSTE
1 PIECE PER BAG - PACK SIZE 10 BAGS



Art.352 APPOGGIA CANNE TIPO C ROD REST TYPE C

 Appoggia canna che blocca con sicurezza il calcio della canna. Con vite e ghiera di regolazione in metallo è ideale per il Carp Fishing.

 Rod rest that holds securely the butt of the rod. Equipped with metal thread and adjusting metal ring. Ideal for Carp Fishing.

 Support canne pour bloqueur en sécurité le talon de la canne. Vis réglable en métal. Idéal pour le Carp Fishing.

BUSTA DA 1 PEZZO - CONF. DA 10 BUSTE
1 PIECE PER BAG - PACK SIZE 10 BAGS

cm 2,6



Art.344 APPOGGIA CANNE A V SOFT "V" ROD REST

 Appoggia canna in materiale plastico resistentissimo con inserti in gomma morbida per non danneggiare la canna.

 Rod rest made of very strong plastic with soft rubber inserts.

 Support canne en plastique très solide avec éléments en caoutchouc.

BUSTA DA 1 PEZZO - CONF. DA 10 BUSTE
1 PIECE PER BAG - PACK SIZE 10 BAGS

cm 9

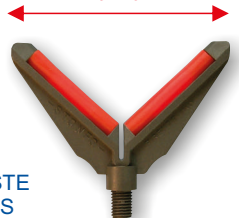

Art.345 **APPOGGIA CANNE A V basculante** DE LUXE "V" ROD REST

 Appoggia canna in materiale plastico resistentissimo con forcella a V basculante per avere sempre una corretta posizione rispetto alla canna. Munito di inserti in gomma per non danneggiare la canna. Attacco a vite con ghieretta regolabile. Fornito con Battipalo omaggio.

 Rod rest made of strong plastic with swinging part to have always the rod in the correct position. Fitted with soft rubber inserts and with adjustable angle lock. Comes complete with free bank stick driver.

 Support canne en plastique très solide avec fourche oscillante qui s'adapte à toutes les positions de pêche. Vis métal réglable et éléments en caoutchouc. Livré avec un enfonce pique gratuit.

BUSTA DA 1 PZ. - CONF. DA 10 BUSTE * 1 PIECE PER BAG - PACK SIZE 10 BAGS

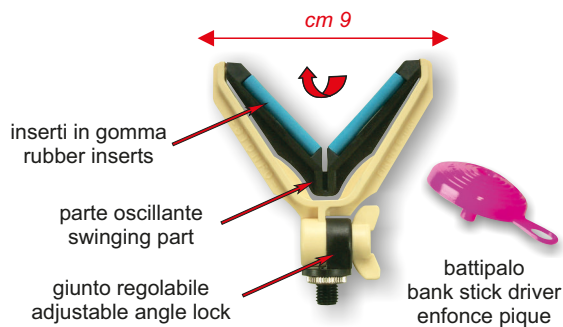

Art.348 **APPOGGIA CANNE TIPO L** ROD REST TYPE L

 Appoggia canna in materiale plastico resistentissimo con inserto in gomma, ideale per la pesca a legering. Munito di attacco a vite regolabile. Fornito con Battipalo omaggio.

 Quiver rod rest made of very strong plastic material. Fitted with soft rubber insert and with adjustable angle lock. Comes complete with free bank stick driver.

 Support canne en plastique très solide avec élément en caoutchouc et vis réglable. Livré avec un enfonce pique gratuit.

BUSTA DA 1 PZ. - CONF. DA 10 BUSTE * 1 PIECE PER BAG - PACK SIZE 10 BAGS

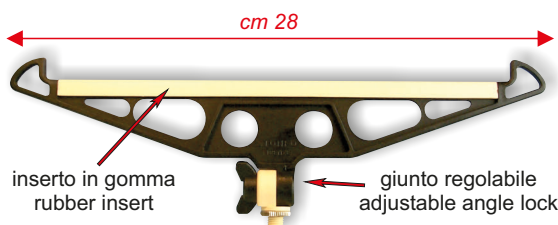

Art.349 **APPOGGIA CANNE TIPO E** ROD REST TYPE E

 Appoggia canna in materiale plastico resistentissimo con inserti in gomma. Munito di attacco a vite regolabile. Fornito con Battipalo omaggio.

 Rod rest made of strong plastic. Fitted with soft rubber inserts and with adjustable angle lock. Comes complete with free bank stick driver.

 Support canne en plastique très solide avec éléments en caoutchouc et vis réglable. Livré avec un enfonce pique gratuit.

BUSTA DA 1 PZ. - CONF. DA 10 BUSTE * 1 PIECE PER BAG - PACK SIZE 10 BAGS

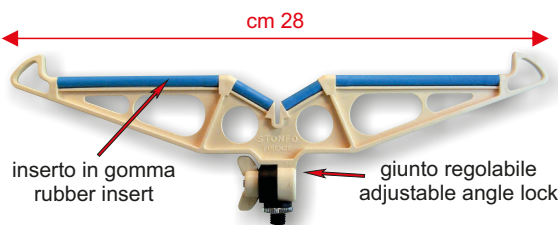

Art.423 **APPOGGIA CANNE TULIPANO 2** "TULIPANO 2" POLE PEG ROD REST

 Appoggia canna con superficie di contatto studiata appositamente per roubaisienne da competizione.

 Rod rest with contact surface specially designed for competition roubaisienne rods.

 Support canne idéal pour pêcher à déboiter. Surface de contact étudiée pour les roubaisiennes de compétition.

BUSTA DA 1 PZ. - CONF. DA 10 BUSTE * 1 PIECE PER BAG - PACK SIZE 10 BAGS

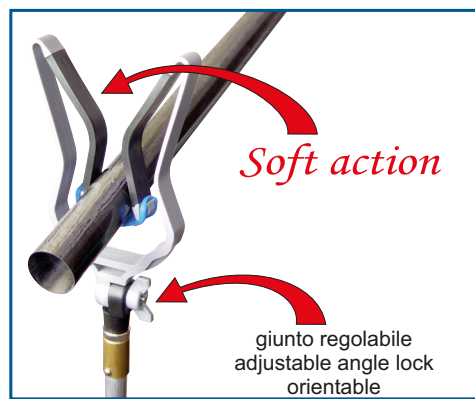

Art.48 **APPOGGIA CANNE ERCOLE** ERCOLE ROD REST

 Modello con struttura in materiale infrangibile e con superficie di contatto in gomma ondulata integrata. Idoneo per canne lunghe e roubaisienne.

 Rod rest in unbreakable plastic material with rippled contact surface in rubber. Suitable for long rods.

 Support canne en matériau incassable avec une surface de contact en caoutchouc ondulé.

BUSTA DA 1 PEZZO - CONF. DA 10 BUSTE * 1 PIECE PER BAG - PACK SIZE 10 BAGS

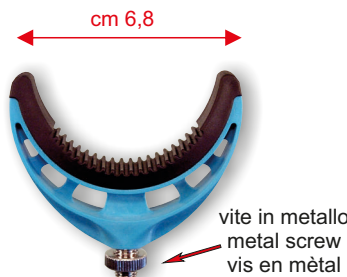

BUSTA DA 1 PEZZO - CONF. DA 10 BUSTE * 1 PIECE PER BAG - PACK SIZE 10 BAGS

Art.49 **MORSETTO PER PALETTI** BANK STICK ATTACHMENT

 Supporto per paletti in alluminio con vite di bloccaggio applicabile a qualsiasi piattaforma.



 Aluminium bank stick attachment for seat platform.

 Support en aluminium avec vis de fixation pour pique.

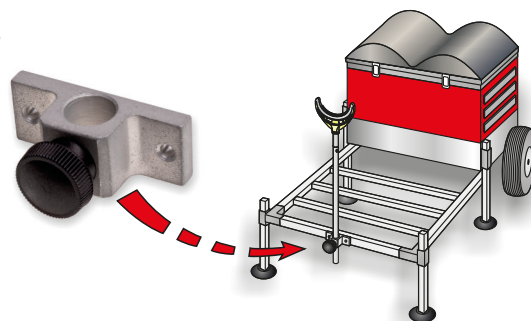
BUSTA DA 1 PEZZO - CONFEZIONE DA 10 BUSTE * 1 PIECE PER BAG - PACK SIZE 10 BAGS





Art.571 **GIUNTO REGOLABILE** BANK STICK CONNECTOR

-  Giunto orientabile con viti universali maschio-femmina in metallo. Permette di bloccare all'angolazione voluta portacanne, nassa ed altri accessori.
-  Angle lock bank stick connector with male-female universal metal screws. Allows to fix rod rests, keepnet, and other accessories to the desired angle.
-  Tête orientable avec vis universelle mâle-femelle en métal. Elle permet de bloquer en position inclinée réglable, support canne, bourriche etc.etc.



BUSTA DA 1 PEZZO - CONFEZIONE DA 10 BUSTE
1 PIECE PER BAG - PACK SIZE 10 BAGS

Art.643 **GIUNTO A VENTOSA**
ANGLE LOCK CONNECTOR WITH SUCKER BASE

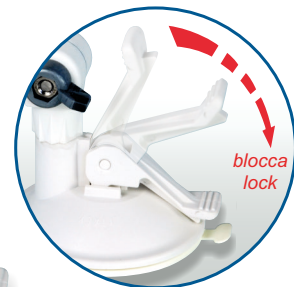

-  Giunto orientabile con filettatura universale (3/8"x20), permette di posizionare all'angolazione voluta appoggiacanne od altri accessori. La potente base a ventosa con azionamento a leva garantisce un rapido e sicuro bloccaggio.
-  Angle lock connector with universal thread (3/8"x20), allows the positioning to the desired angle of rod rest or other accessories. The powerful sucker base with lever device guarantee a quick and stable locking.
-  Tête orientable avec filetage universel (3/8"x20), permet de positionner à l'angulation désirée support canne ou autres accessoires. La puissante base à ventouse avec dispositif à levier garantit un blocage rapide et stable.



potente base a ventosa
powerfull suction cup base
puissante base à ventouse

BUSTA DA 1 PEZZO - CONF. DA 5 BUSTE * 1 PIECE PER BAG - PACK SIZE 5 BAGS

Art.644 **KIT DI BLOCCAGGIO**
ACCESSORIES CLAMP



-  Morsetto completo di giunto regolabile con vite di attacco universale (3/8"x20). Permette il bloccaggio di appoggiacanne, serbidora od altri accessori su pali di sezione circolare o quadra.
-  Clamp equipped with angle lock connector with universal thread (3/8"x20). Allows to fix rod rest, bait tray and other accessories on circular or square section bars.
-  Dispositif de serrage muni de tête orientable avec filetage universelle (3/8"x20). Il permet de bloquer support canne, plateau porte appâts et autres accessoires sur tiges de section circulaire ou carré.



BUSTA DA 1 PEZZO - CONF. DA 5 BUSTE
1 PIECE PER BAG - PACK SIZE 5 BAGS

Art.403 **ALETTE PER GALLEGGIANTI 12 PEZZI**
DART FLIGHTS FOR FLOATS

MIS. PICCOLE - SMALL SIZES Ø 5 - 5,5 MIS. GRANDI - BIG SIZES Ø 6 - 6,5



-  Alette direzionali per galleggianti inglesi, da montare sul tubetto. Disponibili in 4 misure confezionate come segue: Conf. mis.piccole Ø 5 - 5,5 Mis.grandi Ø 6 - 6,5. Colori assortiti.
-  Dart flights for english floats, Available in 4 different diameters in two bags as follow: Small sizes bag Ø 5 - 5,5 Big sizes bag Ø 6 - 6,5 in miscellaneous colours.
-  Ailettes de stabilisation pour flotteurs anglais. Disponibles en 4 diamètres dans deux sachets: Tailles petites Ø 5 - 5,5 Tailles grandes Ø 6 - 6,5. Couleurs assorties.



BUSTA DA 12 PEZZI - CONFEZIONE DA 10 BUSTE * 12 PIECES PER BAG - PACK SIZE 10 BAGS

ASTE PER GALLEGGIANTI BUSTE DA 20



Art.10 **FLOAT ANTENNAE IN BAG 40 SERIES - ANTENNES SÉRIE 40 EN SACHET**

-  Antenne per galleggianti serie 40 mm disponibili nei Ø mm 0,4-0,6-0,8-1,0-1,2-1,5-2,0-2,5.
-  Float antennae series 40 mm. Diameters available: Ø mm 0,4-0,6-0,8-1,0-1,2-1,5-2,0-2,5.
-  Antennes cylindriques série 40 mm pour flotteurs. Diamètres Ø mm 0,4-0,6-0,8-1,0-1,2-1,5-2,0-2,5.

Colori - colours:
10 rosse + 10 gialle
10 red + 10 yellow



Art.13 **FLOAT ANTENNAE IN BAG series 50 and type long - ANTENNES EN SACHET série 50 et type long**

-  Aste per galleggianti lunghe disponibili nei Ø mm 0,6-0,8-1,0-1,2-1,5-1,8-2,0-2,2-3,0-4,5.
-  Float antennae big size. Diameters: Ø mm 0,6-0,8-1,0-1,2-1,5-1,8-2,0-2,2-3,0-4,5.
-  Antennes cylindriques longues pour flotteurs. Diamètres Ø mm 0,6-0,8-1,0-1,2-1,5-1,8-2,0-2,2-3,0-4,5.

BUSTA DA 20 PEZZI - 20 PIECES PER BAG CONFEZIONE DA 10 BUSTE - PACK SIZE 10 BAGS

Art.15

ASTE DOPPIO DIAMETRO BUSTE DA 20

DOUBLE DIAMETRE FLOAT ANTENNAE

Mis-Size 1	Ø max 2,2 - min. 1,2 mm	L. 35
Mis-Size 2	Ø max 3,0 - min. 1,5 mm	L. 40
Mis-Size 3	Ø max 4,5 - min. 2,0 mm	L. 44
Mis-Size 4	Ø max 3,0 - min. 2,0 mm	L. 66
Mis-Size 5	Ø max 4,5 - min. 3,0 mm	L. 70

Colori - colours:
10 rosse + 10 gialle
10 red + 10 yellow

BUSTA DA 20 PEZZI - CONF. DA 10 BUSTE
20 PIECES PER BAG - PACK SIZE 10 BAGS

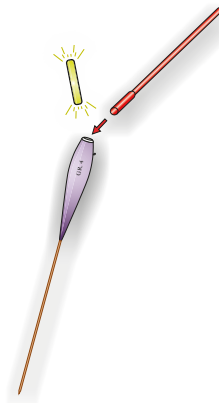

Art.170

ASTE FORATE BUSTA DA 20 PEZZI

HOLLOW FLOAT ANTENNAE - ANTENNES FORÉES POUR FLOTTEURS

Mis-Size 1	Ø ext.mm 1,2	Foro-bore 0,6
Mis-Size 2	Ø ext.mm 1,5	Foro-bore 0,8
Mis-Size 3	Ø ext.mm 2,0	Foro-bore 0,8
Mis-Size 4	Ø ext.mm 2,2	Foro-bore 1,0
Mis-Size 5	Ø ext.mm 3,0	Foro-bore 1,25

Colori - colours:
10 + 10 gialle
10 + 10 yellow

BUSTA DA 20 PEZZI - CONF. DA 10 BUSTE
20 PIECES PER BAG - PACK SIZE 10 BAGS



Art.305

KIT ASTE DOPPIO DIAMETRO

ANTENNAE KIT

Contiene 10 aste doppio diametro vari colori, 10 boccole doppie, 50 ghierette vari colori.

Includes 10 double diameter float antennae, 10 starlight double recess, 50 fluo colored antennae rings.

Comprenant 10 antennes double diamètre, 10 raccords double pour flotteurs, 50 bagues en couleurs assorties.

CONFEZIONE DA 10 BUSTE - PACK SIZE 10 BAGS

Mis sizes	Ø 3,0
	Ø 4,5

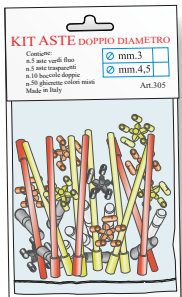

Art.304

KIT ALETTE

FLIGHTS KIT

Contiene 5 alette vari colori, 5 boccole doppie, 30 ghierette vari colori.

Includes 5 float dart flights, 5 starlight double recess, 30 fluo colored antennae rings.

Comprenant 5 ailettes de stabilisation, 5 raccords double pour flotteurs, 30 bagues en couleurs assorties.

CONFEZIONE DA 10 BUSTE - PACK SIZE 10 BAGS

Mis sizes	Ø 3,0
	Ø 4,5

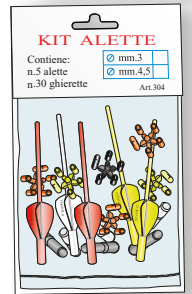

Art.11

ASTE PER GALLEGGIANTI IN SCATOLINA

FLOAT ANTENNAE IN BOX

Scatolina con aste per galleggianti di misure e colori assortiti.

Miscellaneous sizes and colours float antennae box.

Boîte des antennes pour flotteurs. Tailles et couleurs assorties.

BUSTA DA 1 PEZZO - CONF. DA 10 BUSTE 1 PIECE PER BAG - PACK SIZE 10 BAGS



Art.450

ANELLINI PER SCORREVOLI BUSTA DA 20 PZ.

SLIDER FLOAT RINGS - CÉILLETS POUR FLOTTEURS COULISSANTS



Ø int.mm	1,2	1,5	1,8	2,0
----------	-----	-----	-----	-----

BUSTA DA 20 PZ. - CONF. DA 10 BUSTE
20 PCS PER BAG - PACK SIZE 10 BAGS



Art.452

ANELLINI INOX SCORREVOLI BUSTA DA 20 PZ.

STAINLESS STEEL FLOAT SLIDER RINGS - CÉILLETS INOX POUR FLOTTEURS COULISSANTS



Mis.Size	1	2	2,5	3	4
Ø filo-foro	0,4 - 0,8	0,4 - 1,4	0,5 - 0,8	0,5 - 1,0	0,5 - 1,6
Ø wire-bore					

BUSTA DA 20 PZ. - CONF. DA 10 BUSTE
20 PCS PER BAG - PACK SIZE 10 BAGS



Art.451

ANELLINI PER SCORREVOLI P.L.

SLIDER FLOAT RINGS P.L. TYPE - CÉILLETS POUR FLOTTEURS COULISSANTS MOD. P.L.

BUSTA DA 20 PEZZI - CONFEZIONE DA 10 BUSTE
20 PIECES PER BAG - PACK SIZE 10 BAGS



Mis. Size Ø mm 1,2 1,5 1,8



Art.361

GUAINA COLORATA FLUO

MULTIFUNCTION FLUORESCENT TUBING



Tubetti colorati fluorescenti utili per molteplici applicazioni. Se sovrapposti all'astina del galleggiante ne cambiano spessore e colore per migliorarne la visibilità. Ø int. 0,6-0,8-1,0-1,2-1,5.



Multifunction fluorescent colored tubing. Ideal to modify colour and thickness of float antennae to increase the visibility. Ø int. mm 0,6-0,8-1,0-1,2-1,5.



Gaines fluo multifonctions. Idéal pour modifier couleur et grosseur des antennes. Ø int. mm 0,6-0,8-1,0-1,2-1,5.

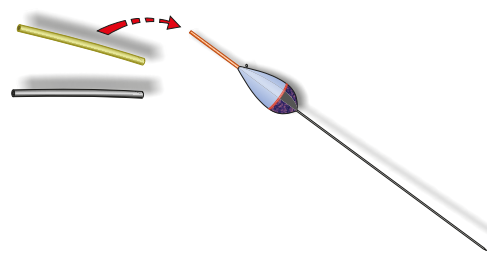

CONFEZIONE DA 10 PEZZI - PACK SIZE 10 PIECES

Art.731

FLOAT CAPS



Tappini in gomma elastica leggerissima di colore fluorescente. Inseriti sull'antenna del galleggiante ne migliorano notevolmente la visibilità. Non variano la portata del galleggiante. Busta assortita con 3 colori e due misure che si adattano su antenne da Ø mm 1,0 a 2,5.



Very light elastic rubber caps in fluorescent color. Inserted on the float antenna, they greatly improve its visibility. They don't vary the carrying capacity of the float. Assorted bag with 3 colors and two sizes that fit on antennas from Ø 1.0 to 2.5 mm.



Embouts en caoutchouc élastique très léger de couleur fluo. Insérés sur l'antenne du flotteur, ils améliorent grandement sa visibilité. Ils ne varient pas la portée du flotteur. Sachet assorti avec 3 couleurs et deux tailles qui s'adaptent sur les antennes de Ø 1,0 à 2,5 mm



BUSTA DA 36 PEZZI - CONF. DA 10 BU. * 36 PCS PER BAG - PACK SIZE 10 BAGS

AVVOLGILENZA STRETTE

NARROW WINDERS

art.9408S	CM 8
art.9410S	CM 10
art.9412S	CM 12
art.9414S	CM 14
art.9416S	CM 16
art.9418S	CM 18
art.9520S	CM 20
art.9522S	CM 22
art.9525S	CM 25
art.9530S	CM 30
art.9535S	CM 35



CONFEZIONE DA 100 PEZZI
PACK SIZE 100 PIECES

WINDERS EXTRACTOR INCLUDED



AVVOLGILENZA LARGHE

WIDE WINDERS - PLOIRS LARGES

art.9408L	CM 8
art.9410L	CM 10
art.9412L	CM 12
art.9414L	CM 14
art.9416L	CM 16
art.9418L	CM 18
art.9520L	CM 20
art.9522M	CM 22

CONFEZIONE DA 100 PEZZI
PACK SIZE 100 PIECES



WINDERS EXTRACTOR INCLUDED



AVVOLGILENZA MINI

EXTRA NARROW WINDERS
PLOIRS EXTRA ÉTROITES

art.9514N	CM 14
art.9516N	CM 16
art.9518N	CM 18
art.9520N	CM 20
art.9522N	CM 22
art.9525N	CM 25

CONFEZIONE DA 100 PEZZI
PACK SIZE 100 PIECES

WINDERS EXTRACTOR INCLUDED

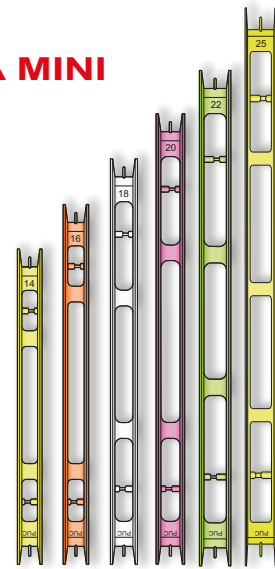

AVVOLGILENZA NORMALI

art.9525L	CM 25
art.9530L	CM 30
art.9535L	CM 35

CONFEZIONE DA 50 PEZZI
PACK SIZE 50 PIECES



NORMAL WINDERS - PLOIRS NORMALS

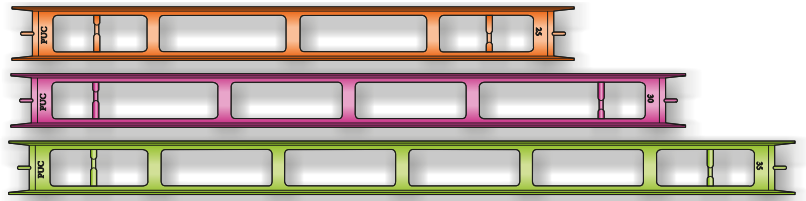

AVVOLGILENZA XL XL WINDERS - PLOIRS EXTRA LARGES

art.9522L	CM 22 XL
art.9525L	CM 25 XL
art.9530L	CM 30 XL
art.9535L	CM 35 XL

CONFEZIONE DA 50 PEZZI
PACK SIZE 50 PIECES

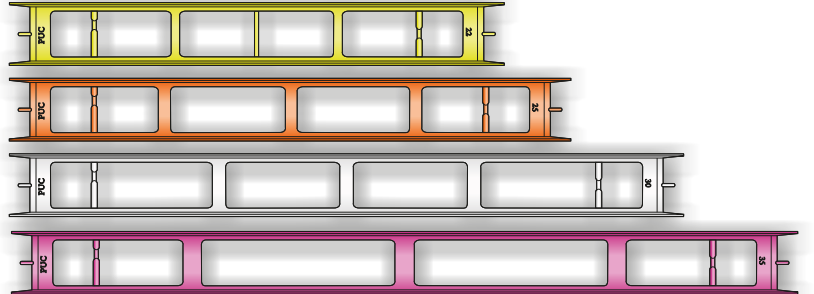

AVVOLGILENZA buste da 5 pezzi WINDERS - PLOIRS

art.9408SS	CM 08 STRETTA - Narrow cm 8
art.9410SS	CM 10 STRETTA - Narrow cm 10
art.9412SS	CM 12 STRETTA - Narrow cm 12
art.9414SS	CM 14 STRETTA - Narrow cm 14
art.9416SS	CM 16 STRETTA - Narrow cm 16
art.9418SS	CM 18 STRETTA - Narrow cm 18
art.9520SS	CM 20 STRETTA - Narrow cm 20
art.9522SS	CM 22 STRETTA - Narrow cm 22
art.9525SS	CM 25 STRETTA - Narrow cm 25
art.9530SS	CM 30 STRETTA - Narrow cm 30
art.9535SS	CM 35 STRETTA - Narrow cm 35

art.9408LS	CM 08 LARGA - Wide cm 8
art.9410LS	CM 10 LARGA - Wide cm 10
art.9412LS	CM 12 LARGA - Wide cm 12
art.9414LS	CM 14 LARGA - Wide cm 14
art.9416LS	CM 16 LARGA - Wide cm 16
art.9418LS	CM 18 LARGA - Wide cm 18
art.9520LS	CM 20 LARGA - Wide cm 20
art.9522MS	CM 22 LARGA - Wide cm 22

BUSTA DA 5 PZ. - CONF. DA 20 BUSTE



art.9525MS	CM 25 NORMALE - Normal cm 25
art.9530MS	CM 30 NORMALE - Normal cm 30
art.9535MS	CM 35 NORMALE - Normal cm 35

art.9522LS	CM 22 EXTRA LARGA - XL cm 22
art.9525LS	CM 25 EXTRA LARGA - XL cm 25
art.9530LS	CM 30 EXTRA LARGA - XL cm 30
art.9535LS	CM 35 EXTRA LARGA - XL cm 35

BUSTA DA 5 PZ. - CONF. DA 10 BUSTE

BOX 260x190x26

Art.732

1 scomparto
1 compartment
1 case



Art.742

6 scomparti
6 compartments
6 cases

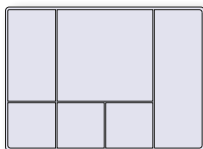

Art.743

12 scomparti
12 compartments
12 cases

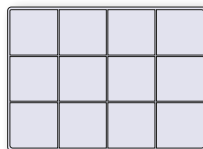

Scatole in materiale plastico leggero e resistenti. Ideali per riporre utensili, materiale di montaggio, ami e minuteria varia. Dim. 26x19x2,6 cm.

Shockproof lightweight plastic boxes. Suitable to store tools, tying material, hooks and small rigs. Dim. 26x19x2.6 cm.

Boîtes en plastique légères et antichoc. Idéales pour ranger outils, matériel de montage, hameçons et divers petits accessoires. Dim. 26x19x2,6 cm.



CONFEZIONE DA 5 PEZZI * PACK SIZE 5 PIECES

AVVOLGILENZA VELA

FLAT FLOAT WINDERS



Avvolgilezza studiate appositamente per riporre e trasportare in sicurezza lenze montate con galleggianti a vela. Prodotte in materiale resistentissimo, la loro forma speciale permette di accoppiarle per risparmiare spazio. Disponibile in due diverse misure di lunghezza cm 32 e cm 42.



Winders specially designed to hold and safely carry flat float rigs. Made of high resistance material, their special shape allows to pair them to save space. Available in two different lengths cm 32 and cm 42.



Ploirs spécialement étudiés pour ranger et transporter en sécurité les lignes montées avec des flotteurs plats. Produits en matériau très résistant, leur forme spéciale permet de les accoupler pour gagner de l'espace. Disponible en deux longueurs de 32 et 42 cm.

BUSTA DA 4 PEZZI - CONF. DA 5 BUSTE
4 PIECES PER BAG - PACK SIZE 5 BAGS



Dim. mm 320 x 70 x 22
Dim. mm 420 x 90 x 25

Art. 9218R

AVVOLGILENZA A RETE

NET WINDER - PLANCHETTE GRILLE

cm 18

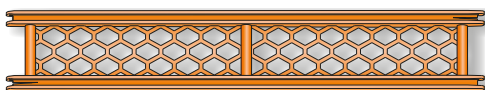

BUSTA DA 6 PEZZI - CONFEZIONE DA 10 BUSTE
6 PIECES PER BAG - PACK SIZE 10 BAGS

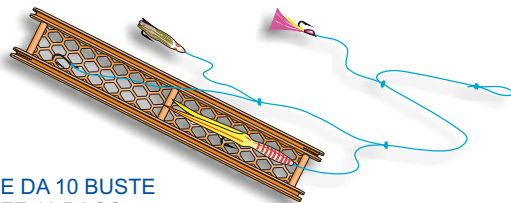

FERMALENZA WINDER ANCHORS - ATTACHE LIGNE

Art. 111

Busta da 24 pz. - Conf. da 10 buste
Bag 24 pcs - Pack size 10 bags
Sachet de 24 pièces

Art. 111-1

Scatola da 48 pz. - Conf. da 10 scatole
Box 48 pcs - Pack size 10 boxes
Boîte de 48 pièces - Conditionnement 10 boîtes



Art. 283

FERMALENZA LUSO

DE LUXE WINDER ANCHORS - ATTACHE LIGNE LUXE

BUSTA DA 20 PEZZI - CONFEZIONE DA 10 BUSTE
20 PIECES PER BAG - PACK SIZE 10 BAGS

gancino in acciaio inox
stainless steel clip

elastico
elastic



FERMALENZA KRISS KRISS WINDER ANCHORS - ATTACHE LIGNE KRISS

Art. 145



Art. 147



Elastico Fermalenza Kriss. La misura piccola è adatta per avvolgilezza di cm 22 di lunghezza max, la misura grande fino a 35 cm.



Elastic Kriss winder anchors. The small size is suitable for winders max 22 cm length, the bigger size for winders max 35 cm.



Attache ligne Kriss. La petite taille est indiquée pour ploirs de 22 cm de longueur max, la grande pour ploirs de 35 cm max.

BUSTA DA 12 PEZZI - CONF. DA 10 BUSTE * 12 PIECES PER BAG - PACK SIZE 10 BAGS

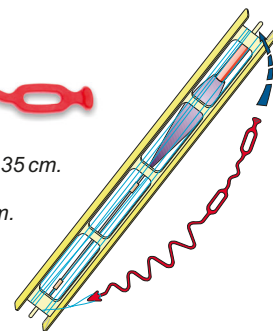

Art. 46

WINDER CLIPS



Permettono di bloccare rapidamente l'avvolgilezza sulla canna da pesca.



Small clips for quick locking of the winder on the fishing rod.



Ils permettent de bloquer rapidement le plioir sur la canne à pêche.

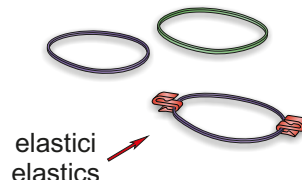
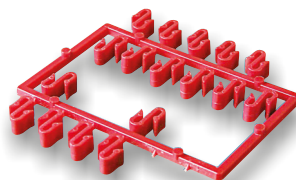

elastici
elastics

BUSTA DA 24 PEZZI - CONFEZIONE DA 10 BUSTE
24 PCS. PER BAG - PACK SIZE 10 BAGS

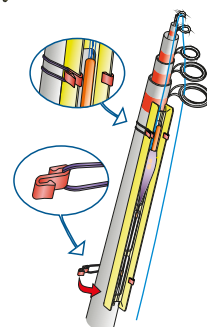

PORTABOBINA SPOOL HOLDER - PORTE BOBINE



Permette di bloccare la bobina del mulinello alla canna, risparmiando spazio ed evitando rotture al filo e al mulinello. Misura piccola per bobine con diametro da mm 41 a 54, misura grande per bobine da mm 54 a 76.



Allows to lock the reel's spool to the rod. It saves room and avoids line and reel breakages. Small size for spools of diameter from 41 mm to 54 mm, big size for spools from 54 to 76 mm.



Il permet de bloquer la bobine du moulinet sur la canne, de gagner de la place et d'éviter les coupures du fil et d'endommager le moulinet. Petit modèle pour bobine au diamètre de mm 41 a 54, grand modèle pour bobine de mm 54 a mm 76.

BUSTA DA 1 PZ - CONFEZIONE DA 10 PEZZI
1 PIECE PER BAG - PACK SIZE 10 PIECES

BILANCINE SCALES



Bilancine con molla in acciaio inox. Piccolissime, leggere, precise. Definizione misura 100 g (200 g art.487). Impugnatura comoda. Vite regolazione dello zero. Gancio di pesatura a scomparsa



Scales with spring in stainless steel. Very small, lightweight, accurate. Measure definition 100 g (200 g art.487). Comfortable handle. Can be zeroed by the screw. Folding weighing hook.



Pesons avec ressort en acier inox. Très petits, légers, précis. Graduation par 100 g (200 g art.487). Bonne poignée. Vis de réglage remise à zéro. Crochet de pesée repliable.

BUSTA DA 1 PZ - CONFEZIONE DA 10 PEZZI
1 PIECE PER BAG - PACK SIZE 10 PIECES

TUBETTO IN PVC PVC TUBING - GAINE PVC

NR. ART.	Ø INT.
Art.301/08	mm 0,8
Art.301/10	mm 1,0
Art.301/15	mm 1,5

2 METRI PER BUSTA - CONF. DA 10 BUSTE
2 METRES PER BAG - PACK SIZE 10 BAGS

SCOUBIDOU PVC GARA

MATCH PVC FLOAT SLEEVES - GAINES PVC POUR FLOTTEURS

Art.31-7

Misure piccole - Small Sizes
Ø mm 0,2 -0,3 -0,5 -0,8 -1,0 -1,2

Art.31-8

Misure grandi - Big Sizes
Ø mm 1,3 -1,5 -1,8 -2,0 -2,5

BUSTA DA 1 PEZZO - CONFEZIONE DA 10 BUSTE 1 PIECE PER BAG - PACK SIZE 10 BAGS

SCOUBIDOU PVC

PVC FLOAT SLEEVES - GAINES PVC POUR FLOTTEURS

Art.31-3

Scatolina misure assortite
Box miscellaneous sizes
Boîte tailles assorties

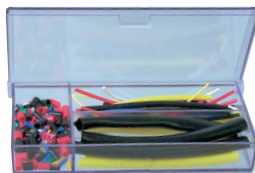

BUSTA DA 1 PEZZO - CONFEZIONE DA 10 BUSTE
1 PIECE PER BAG - PACK SIZE 10 BAGS

Art.31

Busta misure assortite
Bag miscellaneous sizes
Sachet tailles assorties

CONFEZIONE DA 10 BUSTE
PACK SIZE 10 BAGS



SCOUBIDOU PVC MORBIDO

SOFT PVC FLOAT SLEEVES
GAINES PVC SOUPLE POUR FLOTTEURS
Ø mm 4 - 4,5 - 5 - 6 - 7

Art.31-5

Scatolina misure assortite
Box miscellaneous sizes
Boîte tailles assorties



Art.31-6

Busta misure assortite
Bag miscellaneous sizes
Sachet tailles assorties



BUSTA DA 1 PEZZO - CONFEZIONE DA 10 BUSTE
1 PIECE PER BAG - PACK SIZE 10 BAGS

CONFEZIONE DA 10 BUSTE - PACK SIZE 10 BAGS



Art.30-3 **SCOUBIDOU SILICONE**

BOX SILICONE FLOAT SLEEVES - GAINES SILICONE POUR FLOTTEURS

Scatolina misure assortite
Box miscellaneous sizes
Boîte tailles assorties

BUSTA DA 1 PEZZO - CONFEZIONE DA 10 BUSTE
1 PIECE PER BAG - PACK SIZE 10 BAGS



TUBETTI SILICONE TRASP. IN SCATOLINA

BOX CLEAR SILICON TUBE - GAINES EN SILICONE TRANSPARENT

Art.30-4 Misure piccole - Small Sizes
Ø mm 0,2 -0,3 -0,5 -0,7 -1,0

Art.30-5 Misure grandi - Big Sizes
Ø mm 0,7 -1,0 -1,2 -1,5 -2,0

BUSTA DA 1 PEZZO - CONFEZIONE DA 10 BUSTE
1 PIECE PER BAG - PACK SIZE 10 BAGS



SCOUBIDOU SILICONE GARA

MATCH SILICONE FLOAT SLEEVES - GAINES SILICONE POUR FLOTTEURS

Art.30-6 Misure piccole - Small Sizes
Ø mm 0,2 -0,3 -0,5 -0,7 -1,0

Art.30-7 Misure grandi - Big Sizes
Ø mm 0,7 -1,0 -1,2 -1,5 -2,0

BUSTA DA 1 PEZZO - CONFEZIONE DA 10 BUSTE
1 PIECE PER BAG - PACK SIZE 10 BAGS



GUAINA SILICONE TRASPARENTE

SILICONE TUBE - GAINES EN SILICONE TRANSPARENT

Art.29/02	Ø INT. mm 0,2
Art.29/03	Ø INT. mm 0,3
Art.29/05	Ø INT. mm 0,5

Art.30/07	Ø INT. mm 0,7
Art.30/10	Ø INT. mm 1,0

Art.30-1/12	Ø INT. mm 1,2
Art.30-1/15	Ø INT. mm 1,5
Art.30-1/20	Ø INT. mm 2,0

Art.30-2/25	Ø INT. mm 2,5
Art.30-2/30	Ø INT. mm 3,0
Art.30-2/40	Ø INT. mm 4,0

BUSTA DA 1 METRO - CONFEZIONE DA 10 BUSTE
1 METER PER BAG - PACK SIZE 10 BAGS



TUBO RESTRINGENTE MIS. ASSORTITE

SHRINK TUBING MISCELLANEOUS SIZES

GAINE THERMORETRACTABLE MIXTE Ø 1,6 - 2,4 - 3,2 - 4,8 - 6,4

Tubetto che si restringe fino al 50% del suo diametro originale a bassa temperatura. Confezione con varie misure assortite.

Shrink tube, that shrinks to half of its diameter at low temperature. Bags with miscellaneous sizes.

Gaine rétractable à 50% à basse température. Sachet avec diamètres assortis.

Art.300-1 Colore Nero - Black

Art.131 Trasparente - Clear

80 CM PER BUSTA - CONFEZIONE DA 10 BUSTE
80 CENTIMETRES PER BAG - PACK SIZE 10 BAGS



TUBO RESTRINGENTE SHRINK TUBING - GAINES THERMORETRACTABLE

NERO-BLACK	Ø INT.	RITRAE-SHRINKS TO
Art.300/16	mm 1,6	mm 0,8
Art.300/24	mm 2,4	mm 1,2
Art.300/32	mm 3,2	mm 1,6
Art.300/48	mm 4,8	mm 2,4
Art.300/64	mm 6,4	mm 3,2

TRASPARENTE-CLEAR	Ø INT.	RITRAE-SHRINKS TO
Art.300C16	mm 1,6	mm 0,8
Art.300C24	mm 2,4	mm 1,2
Art.300C32	mm 3,2	mm 1,6
Art.300C48	mm 4,8	mm 2,4
Art.300C64	mm 6,4	mm 3,2

64 CM PER BUSTA - CONFEZIONE DA 10 BUSTE * 64 CENTIMETRES PER BAG - PACK SIZE 10 BAGS



GOMMINO SALVANODO

SHOCK ABSORBER - PROTÈGE NOEUDS

Cilindretti ammortizzatori proteggi-nodo.

Save knot shock absorber.

Amortisseurs protège nœud.

NR. ART.	Ø EXT.
Art.209-3	mm 3
Art.209-4	mm 4
Art.209-6	mm 6

BUSTA DA 15 PEZZI - CONFEZIONE DA 10 BUSTE
15 PIECES PER BAG - PACK SIZE 10 BAGS

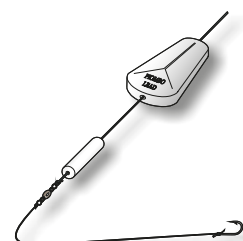

Art.209-1S **GOMMINO SALVANODO SCATOLINA**

SHOCK ABSORBER (BOX) - PROTÈGE NOEUDS (BOÎTE)

SCATOLINA DA 45 PEZZI - CONFEZIONE DA 10 SCATOLINE
45 PIECES PER BOX - PACK SIZE 10 BOXES

misure assortite
miscellaneous sizes
tailles assorties



GOMMINO SALVANODO MORBIDO

**SOFT SHOCK ABSORBER
PROTÈGE NOEUDS SOUPLE**



*Cilindretti ammortizzatori proteggi-nodo.
Tipo morbido.*

Save knot shock absorber. Soft type.

Amortisseurs protège nœud. Type souple.

BUSTA DA 15 PEZZI - CONFEZIONE DA 10 BUSTE
15 PIECES PER BAG - PACK SIZE 10 BAGS

NR. ART.	Ø EXT.
Art.257-3	mm 3
Art.257-4	mm 4
Art.257-6	mm 6

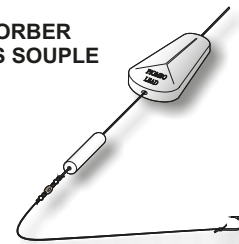

Art.257-1S **GOMMINO SALVANODO MORBIDO SCATOLINA**

SOFT SHOCK ABSORBER (BOX) - PROTÈGE NOEUDS SOUPLE (BOÎTE)

SCATOLINA DA 45 PEZZI - CONFEZIONE DA 10 SCATOLINE
45 PIECES PER BOX - PACK SIZE 10 BOXES

misure assortite
miscellaneous sizes
tailles assorties



SECCHIELLI

**BAIT BUCKETS WITH PERFORATED LIDS
SEAUX EN PLASTIQUE PERCÉS SUR LE COUVERCLE**

CONFEZIONE DA 10 PEZZI
PACK SIZE 10 PIECES

Art.279

Secchiello da 1/2 litro



Art.280

Secchiello da 1 litro



SCATOLE PORTA ESCHE

BAIT BOXES WITH PERFORATED LIDS - BOÎTES À ASTICOTS PERCÉES SUR LE COUVERCLE

Art.98 Scatola Ø 50

CONF. DA 50 PEZZI
PACK SIZE 50 PIECES



Art.99 Scatola Ø 75

CONF. DA 40 PEZZI
PACK SIZE 40 PIECES



Art.99-1 Scatola Ø 110

CONF. DA 20 PEZZI
PACK SIZE 20 PIECES

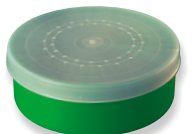

SCATOLE PER ESCHE QUADRATE

SQUARE BAIT BOXES - BOÎTES CARRÉES POUR ÈSCHES



Quattro misure con coperchio forato e chiusura di sicurezza. Gli articoli 54-55-56 sono disponibili anche in colore bianco per visualizzare meglio alcuni tipi di esche come il ver de vase.



Four sizes with pierced lid and safety closing. The items 54-55-56 are also produced in white colour for easy bait identification.



Quatre mesures avec couvercle percé et fermeture de sûreté. Les articles 54-55-56 sont produits aussi en couleur blanc pour voir mieux certains types des esches.

CONFEZIONI DA 10 PEZZI - PACK SIZE 10 PIECES

Art.55 LITRI 1,2

Art.56 LITRI 1,8

Art.54 LITRI 0,6



Art.57

LITRI 0,7 comp.4

SCATOLE PER ESCHE FONDO A RETE

**MESH SQUARE BAITS BOXES
BOÎTES CARRÉE POUR ÈSCHES AVEC FILET**



Scatole quadrate con fondo a rete per una migliore aerazione delle esche.



Square bait boxes equipped with mesh to allow aeration of the bait.



Boîtes munies sur le fond d'un filet pour une meilleure aération des asticots.

CONFEZIONI DA 10 PEZZI - PACK SIZE 10 PIECES

Art.55R LITRI 1,2

Art.57R LITRI 0,7 comp.4



Art.543 **SETACCIO CM 15x15** RIDDLE



Setaccio con rete bianca 15x15 cm per scatoline quadrate da litri 1,2 e 1,8. Ideale per ver de vase.



Riddle with white mesh 15x15 cm for square bait boxes 1,2 and 1,8 litres. Ideal for ver de vase.



Tamis avec filet blanc 15x15 cm pour boîtes carrées de 1,2 et 1,8 litres. Idéal pour ver de vase.

BUSTA DA 1 PEZZO - CONFEZIONE DA 10 PEZZI
1 PIECE PER BAG - PACK SIZE 10 PIECES



Art.365-3 PORTASCATOLE RIPIEGABILE 2 FOLDING BAIT TRAY 2 P - PORTE APPÂTS REPLIABLE 2 P

 Pratico e compatto portascatole ripiegabile. Modello con due alloggiamenti: uno per scatola piccola (art.54) e l'altro per scatola grande (art.55 art.56 art.57 art.55R art.57R).

 A very handy folding tray for square bait boxes. Two compartments model: one for small box (item 54) and the other one for big box (item 55 item 56 item 57 item 55R item 57R).

 Plateau de rangement repliable pour appâts. Modèle pour deux boîtes: un compartiment pour boîte petite (art.54) et l'autre pour boîte grande (art.55 art.56 art.57 art.55R art.57R).



CONFEZIONE DA 1 PEZZO - PACK SIZE 1 PIECE

Art.366-3 PORTASCATOLE RIPIEGABILE 4 FOLDING BAIT TRAY 4 P - PORTE APPÂTS REPLIABLE 4 P

 Pratico e compatto portascatole ripiegabile. Modello con quattro alloggiamenti: due per scatole piccole (art.54) e due per scatole grandi (art.55 art.56 art.57 art.55R art.57R).

 A very handy folding tray for square bait boxes. Four compartments model: two for small boxes (item 54) and the others for big boxes (item 55 item 56 item 57 item 55R item 57R).

 Plateau de rangement repliable pour appâts. Modèle pour quatre boîtes: deux compartiments pour boîtes petites (art.54) et deux pour boîtes grandes (art.55 art.56 art.57 art.55R art.57R).

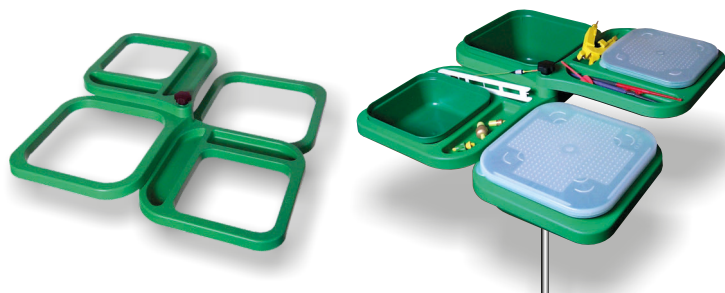

CONFEZIONE DA 1 PEZZO - PACK SIZE 1 PIECE

TENDE PER ESCE BAITS TENTS - TENTES PROTÈGE APPÂTS

 Per proteggere le esche dal sole e dalla pioggia. Applicabile su tutti i portascatole.

 For baits protection against sun and rain. It suits all kind of bait tray.

 Pour la protection des appâts contre le soleil et la pluie. Applicable sur toute sorte de porte-appâts.

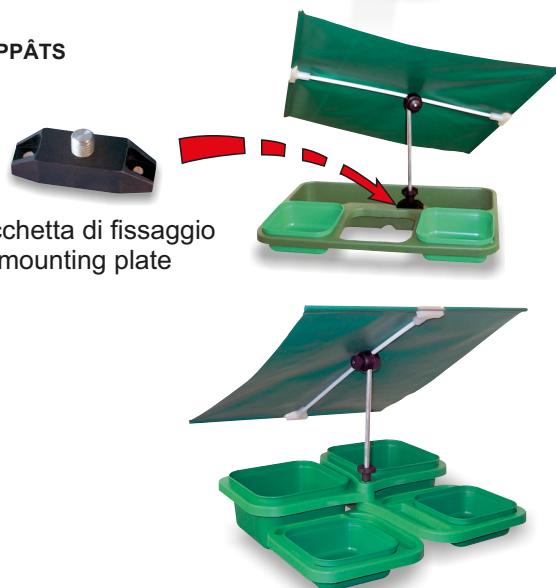
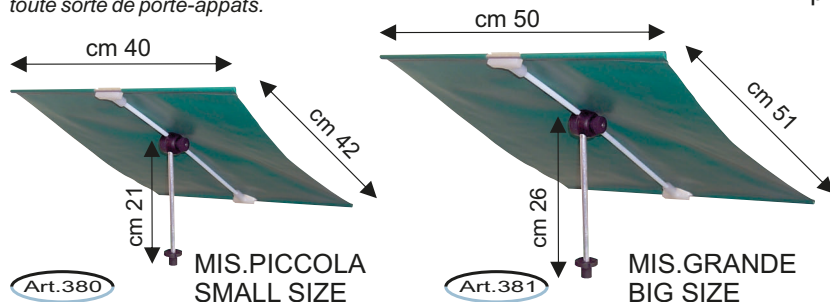

placchetta di fissaggio mounting plate

CONFEZIONE DA 1 PEZZO - PACK SIZE 1 PIECE

SCATOLINE PORTAPIOMBO Ø 30 SMALL SINKER BOXES - PETITES BOÎTES POUR PLOMBS

 Art.96 Con coperchio con foro With perforated lid Avec couvercle percé



 Art.96V Con coperchio a vite With screwed lid Avec couvercle à vis



CONFEZIONE DA 200 PEZZI - PACK SIZE 200 PIECES

SCATOLE PORTAPIOMBO 5 SCOMPARTI SINKER BOXES (FIVE COMPARTMENTS) BOÎTES POUR PLOMBS À CINQ CASES

 Art.274 Ø mm 65 Misura piccola Small size



 Art.275 Ø mm 85 Misura grande Big size



CONFEZIONE DA 10 PEZZI - PACK SIZE 10 PIECES

SCATOLINE COMPONIBILI MODULAR BOXES - PETITES BOÎTES POUR HAMEÇONS



 Scatoline componibili in plastica con coperchio a slitta trasparente per piccola minuteria come girelle, ami, perline etc.

 Modular boxes with sliding clear lid, ideal to contain small accessories like swivels, hooks, beads etc.

 Petites boîtes modulables avec couvercle coulissant transparent.

Dim.mm 40x27x9





-  Art.97 SCATOLINA PORTAAMI - MICRO SIZE SLIDE BOX (200 per bag)
-  Art.471 SCATOLINE COMPONIBILI - MODULAR BOXES (10 per bag, pack size 10 bags)

SCATOLE STANDARD MM 150X100X20 STANDARD BOXES

Art.242-1 Senza scomparti
Without compartments - Sans cases

Art.242-2 Vari scomparti
With compartments - Avec cases

 Scatole con coperchio trasparente prodotte in materiale antiurto. Possono essere accoppiate grazie ai piedini ad incastro.

 Strong plastic boxes with clear lid. You can pair them by their interlocking pins.

 Boîtes en matériau résistant, jumelables, avec couvercle transparent.



CONFEZIONE DA 6 SCATOLINE
PACK SIZE 6 BOXES

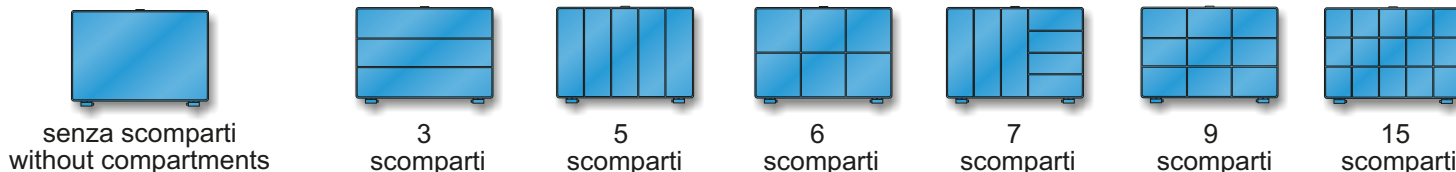

SCATOLE LUSSO mm 150x100x20 DE LUXE BOXES

Art.242-3 Senza scomparti
Without compartments - Sans cases

Art.242-4 Vari scomparti
With compartments - Avec cases

 Scatole serie lusso prodotte con materiale resistentissimo agli urti e alla corrosione delle esche siliciche. Possono essere accoppiate grazie ai piedini ad incastro.

 Very strong plastic boxes, de lux series. You can pair them by their interlocking pins. Worm resistant.

 Boîtes luxe fluo, incassables, anti-corrosion, jumelables.

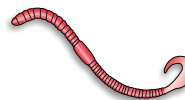

CONFEZIONE DA 6 SCATOLINE
PACK SIZE 6 BOXES

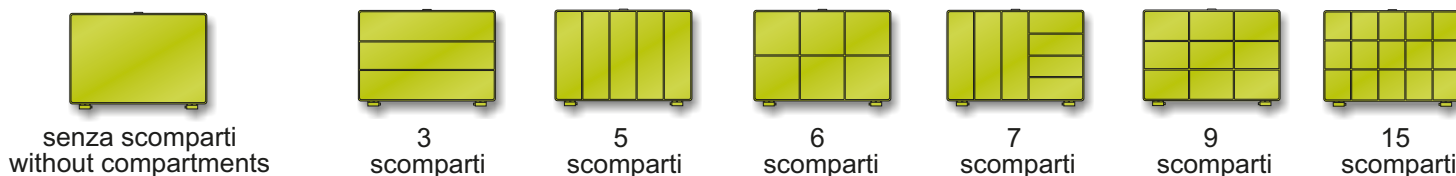

Art.514 LIGHT BOX dim.150x100x20 mm

 Scatola anti-urto, leggera, trasparente.

 Shockproof lightweight clear box.

 Boîte légère, antichoc, transparente.

BUSTA DA 1 PZ. - CONF. DA 6 BUSTE
1 PIECE PER BAG - PACK SIZE 6 BAGS





7 COMP.

9 COMP.

15 COMP.

Art.536 SCATOLE F TYPE F TYPE BOXES dim.120x85x25 mm

 Scatole anti-urto, leggere, trasparenti, compatte. Adatte per contenere vari tipi di artificiali, mosche, minuteria etc. Munite di piccolo foro per l'applicazione al Safety Cord.

 Shockproof lightweight clear boxes. Compact dimensions. Suitable to store various types of flies, lures and small rigs. Fitted with small hole for attaching to Safety Cord.

 Boîtes légères, antichoc, transparentes, compactes. Idéales pour ranger mouches, leurres et divers petits accessoires. Munies de petit trou d'accroche au Safety Cord.

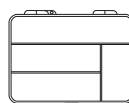

COMP. 4

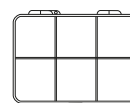

COMP. 6

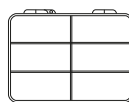

6 ORIZ.

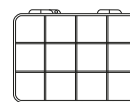



COMP.12



BUSTA DA 1 PEZZO - CONFEZIONE DA 6 BUSTE
1 PIECE PER BAG - PACK SIZE 6 BAGS

Art.233 S **MAGNETIC BOX dim.95x45x16 mm**

 Scatolina con fondo magnetico a cinque scomparti con pinzetta in metallo.

 Five compartments magnetic box supplied with metal tweezers.

 Boîte avec fond magnétique et pince en métal.

BUSTA DA 1 PEZZO - CONFEZIONE DA 10 BUSTE
1 PIECE PER BAG - PACK SIZE 10 BAGS

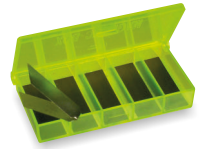

Art.231 **BABY MAGNETE dim. 85x57x16 mm**

BABY MAGNETIC BOX

 Scatola magnetica tascabile doppia, resistente agli urti, con 13 scompartimenti di varia grandezza, ognuno dotato di piano inclinato per facilitare l'estrazione degli ami. La scatola è fornita di penna magnetica.

 Pocket double sided magnetic box with 13 compartments. Each compartment has an inclined plane to take hooks out of the box easily. Supplied with a magnetic pencil.

 Boîte magnétique pochable double, incassable avec 13 compartiments. Plan incliné pour extraire les hameçons au moyen d'un stylo magnétique.

BUSTA DA 1 PEZZO - CONF. DA 3 BUSTE * 1 PIECE PER BAG - PACK SIZE 3 BAGS

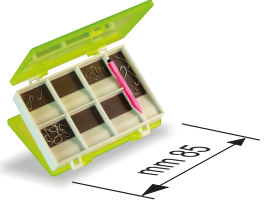

Art.267 S **ORANGE MAGNETIC dim.120x80x13 mm**

ORANGE MAGNETIC

 Scatola magnetica resistente agli urti, con 10 scompartimenti, ognuno dotato di piano inclinato per facilitare l'estrazione degli ami. La scatola è fornita di una penna magnetica che consente la presa di un solo amo.

 Magnetic box with 10 compartments. Each compartment has an inclined plane to take hooks out of the box easily. Supplied with a magnetic pencil.

 Boîte magnétique incassable avec 10 compartiments. Plan incliné pour extraire les hameçons au moyen d'un stylo magnétique.

BUSTA DA 1 PEZZO - CONFEZIONE DA 10 BUSTE
1 PIECE PER BAG - PACK SIZE 10 BAGS



Art.259 S **DOPPIO MAGNETE dim.120x80x19 mm**

DOUBLE MAGNETIC BOX

 Scatola magnetica doppia resistente agli urti, con 31 scompartimenti di varia grandezza, ognuno dotato di piano inclinato per facilitare l'estrazione degli ami. La scatola è fornita di due penne magnetiche.

 Double sided magnetic box with 31 compartments. Each compartment has an inclined plane to take hooks out of the box easily. Supplied with two magnetic pencils.

 Boîte magnétique double incassable avec 31 compartiments. Plan incliné pour extraire facilement les hameçons. Munie de deux stylos magnétiques.

BUSTA DA 1 PEZZO - CONFEZIONE DA 10 BUSTE
1 PIECE PER BAG - PACK SIZE 10 BAGS



Art.248 S **SUPER MAGNETE dim.150x100x14 mm**

SUPER MAGNETIC BOX

 Scatola magnetica resistente agli urti, con 14 scompartimenti, appositamente studiata per contenere ami di svariate dimensioni. Ogni scomparto ha un piano inclinato non magnetizzato per facilitare l'estrazione degli ami con l'apposita penna magnetica.

 Magnetic box with 14 compartments. Specially designed to contain hooks of various sizes. Each compartment has an inclined plane to take hooks out of the box easily. Besides a magnetic pen allows to get only one hook at a time.

 Boîte magnétique incassable à 14 compartiments, spécialement conçue pour contenir hameçons de toutes les dimensions. Chaque compartiment est doté d'un plan incliné pas magnétisé pour extraire les hameçons sans difficulté. Un stylo magnétique permet de prendre facilement un hameçon à la fois.

BUSTA DA 1 PEZZO - CONFEZIONE DA 10 BUSTE
1 PIECE PER BAG - PACK SIZE 10 BAGS



LIGHT MAGNETIC BOXES dim.150x100x20 mm

 Scatole anti-urto, leggere, trasparenti, munite di dischi magnetici in ogni scomparto.

 Clear boxes with magnetic discs on the bottom. Shockproof and lightweight.

 Boîtes magnétiques, légères, antichoc, transparents.

BUSTA DA 1 PEZZO - CONFEZIONE DA 6 BUSTE
1 PIECE PER BAG - PACK SIZE 6 BAGS

Art.270S



9 SCOMPARTI
9 DIVISIONS

Art.271S



15 SCOMPARTI
15 DIVISIONS

Art.584 **COPRINODO** KNOT COVER



Colori - colours:
 neutro - natural
 giallo - yellow
 arancio - orange
 verde - green
 nero - black

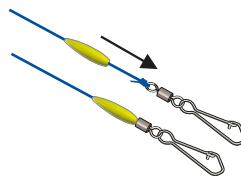

Italy Gommino coprinodo utilissimo per ogni genere di pesca. La sua forma biconica permette un passaggio agevole dagli anelli della canna. Fornito in 3 grandezze e 5 diversi colori è ottimo per la giunzione coda-finale e come rifinitura per streamers ed esche artificiali.

UK Rubber knot cover suitable for all types of fishing. Its biconical shape allows easy passing through rod guides. Supplied in 3 sizes and 5 different colours, it is ideal for fly line-leader connection or for finishing of streamers and lures.

France Couvre-nœud indiqué pour tous les types de pêche. Sa forme biconique permet un passage facile dans les anneaux. Disponible en 3 tailles et 5 couleurs est idéal pour couvrir la jonction soie-ligne et pour la finition des streamers et leurres.

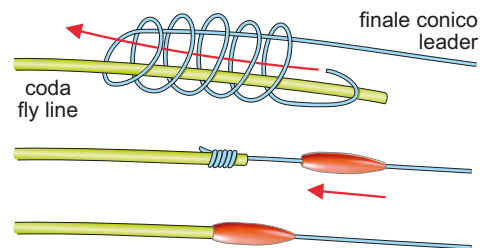

BUSTA DA 24 PEZZI - CONF. DA 10 BUSTE * 24 PIECES PER BAG - PACK SIZE 10 BAGS

Art.706 **COPRINODO MAXI** KNOT COVER MAXI

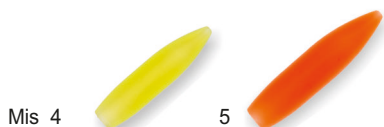

Colori - colours:
 neutro - natural
 giallo - yellow
 arancio - orange
 verde - green
 nero - black

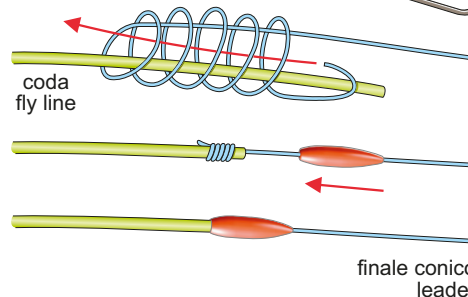
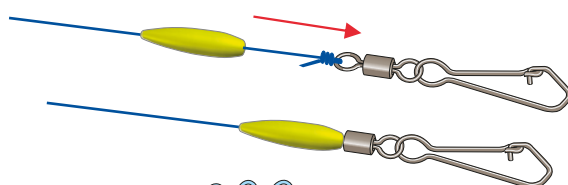

Italy Gommino coprinodo prodotto in due misure più grandi, ideale per l'utilizzo con monofili, elastici e code di dimensioni maggiori. La sua forma biconica permette un passaggio agevole dagli anelli della canna. Disponibile in cinque diversi colori.

UK Rubber knot cover produced in two bigger sizes, ideal for monofilaments, elastics and fly lines of larger diameter. Its biconical shape allows easy passing through rod guides. Available in 5 different colours.

France Couvre-nœud produit en deux tailles plus grandes, idéal pour monofilaments, élastiques et soies de plus grand diamètre. Sa forme biconique permet un passage facile dans les anneaux. Disponible en 5 différents couleurs.

BUSTA DA 12 PEZZI - CONFEZIONE DA 10 BUSTE * 12 PER BAG - PACK SIZE 10 BAGS

Art.716 **COPRINODO SLIM** NEW 2020

SLIM KNOT COVER - COUVRE NŒUD SLIM

Italy Tubetto coprinodo di forma cilindrica, con spessore sottile ed estremità conica. Ideale per l'utilizzo su girelle, microganci e per ogni montatura in cui si richiede la massima leggerezza e compattezza. Munito di micro rilievi per agevolare la presa, può essere accorciato in base all'utilizzo. Prodotto in tre misure e quattro colori che permettono il mimetismo od una perfetta visibilità del coprinodo.

UK Knot cover tubes with thin thickness and smooth conical end. Ideal for use on swivels, micro-hooks and on any rig where maximum lightness and compactness is required. Equipped with micro-reliefs to make them easier to grip. They can be shortened depending on use. Produced in 3 sizes and 4 colors that allow camouflage or perfect visibility of the knot cover.

France Tubes couvre-nœud avec une épaisseur mince et extrémité conique lisse. Idéaux pour une utilisation sur émerillons, micro-crochets et pour chaque montage où une légèreté et une compacité maximales sont nécessaires. Munis de micro-reliefs pour les rendre plus faciles à saisir. Ils peuvent être raccourcis en fonction de l'utilisation. Disponibles en 3 tailles et 4 couleurs qui permettent le camouflage ou une visibilité parfaite de couvre-nœud.

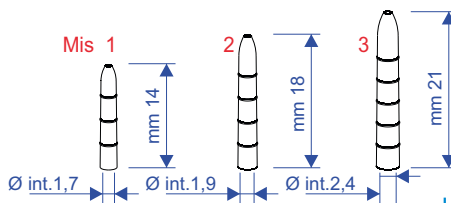

Colori - colours:
 arancio-orange
 bianco-white
 giallo-yellow
 mimetic grey-green

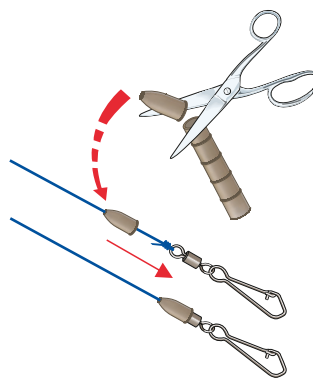

BUSTA DA 12 PEZZI - CONF. DA 10 BUSTE * 12 PER BAG - PACK SIZE 10 BAGS

Art.708 **NIPPER STONFO**

Italy Taglia filo in acciaio inox munito di spillo per la pulizia dell'occhiello dell'amo. L'impugnatura ergonomica in materiale anti-scivolo ne incrementa l'efficienza.

UK Stainless steel nipper equipped with hook eye cleaner. The antislip ergonomic handle improve its efficiency.

France Nipper en acier inox équipé d'une épingle pour déboucher l'ocillet de l'hameçon. La poignée ergonomique en matériau antidérapant augmente son efficacité.



BUSTA DA 1 PEZZO - CONFEZIONE DA 10 BUSTE
 1 PER BAG - PACK SIZE 10 BAGS

Art.679 STONFO ROD HOLDER

 Piccolo e leggero permette di assicurare la canna al gilet per avere le mani libere durante le operazioni di cambio dell'artificiale, sostituzione del finale, slamatura del pesce etc.etc. Realizzato in gomma ad alta elasticità Stonfo Rod Holder si fissa al gilet grazie ad una speciale clip a cursore. Ideale per ogni tipo di canna da 7 a 10 mm di diametro.

 Compact and lightweight allows to hang the rod securely to the vest in order to have your hands free while changing the lure, replacing the tippet, releasing a fish etc.etc. Made of highly elastic rubber the Stonfo Rod Holder can be attached to the vest by a special slider clip. Ideal for every type of rod from 7 mm to 10 mm diameter.

 Compact et léger, il permet de maintenir la canne solidement au gilet pour avoir les mains libres pendant le changement de leurre, le remplacement de bas de ligne, le décrochage d'un poisson etc.etc. Il est produit en caoutchouc très élastique, le Stonfo Rod Holder se fixe à la veste avec une spéciale agrafe à curseur. Idéal pour tous les types de canne de 7 mm à 10 mm de diamètre.

BLISTER DA 1 PEZZO - CONFEZIONE DA 5 PEZZI
1 PIECE BLISTER PACK - PACK SIZE 5 PIECES



Art.533 SAFETY CORD

 Molla in materiale plastico durevole con clip e moschettone. Utilissima per agganciare qualsiasi utensile, scatola o altri accessori al gilè o ai pantaloni.

 Spring, made of durable plastic material, with clip and snap. Suitable for attaching tools, boxes or other accessories on your vest or pants.

 Ressort en plastique durable avec clip et agrafe. Très utile pour accrocher à votre gilet ou pantalon outils, boîtes ou autres accessoires.

BUSTA DA 1 PEZZO - CONF. DA 10 BUSTE
1 PIECE PER BAG - PACK SIZE 10 BAGS

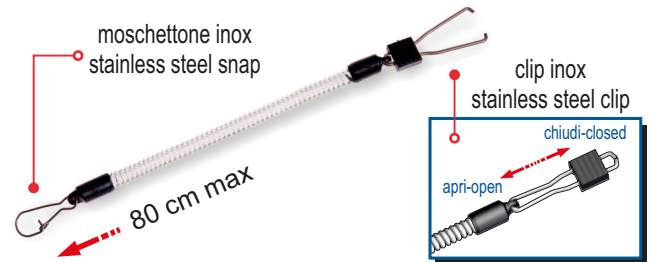

Art.525 BOTTON SERVICE

 Bottone di servizio con molla in materiale plastico durevole e di ottima potenza. Leggerissimo e compatto si applica al gilet per mezzo di una spilla di sicurezza. Estensione massima della molla cm 40. Moschettone in acciaio inox.

 Light and compact retractor. The plastic spring is powerful, durable and can be extended to 40 cm. Equipped with safety pin attachment for maximum security and stainless steel snap.

 Bouton de service petit et léger. Le ressort en plastique est puissant, durable et s'allonge jusqu'à 40 cm. Equipé avec épingle de sûreté et agrafe en acier inox.

BUSTA DA 1 PEZZO - CONF. DA 10 BUSTE
1 PIECE PER BAG - PACK SIZE 10 BAGS



Art.526 BOTTON SERVICE DOPPIO

 Bottone di servizio con doppia molla in materiale plastico durevole e di ottima potenza. Leggerissimo e compatto si applica al gilet per mezzo di una spilla di sicurezza. Estensione massima delle molle cm 35. Munito di gomma ondulata espansa ad alta densità utile per appendere le mosche. Moschettoni in acciaio inox.

 Light and compact retractor with double plastic spring. The springs are powerful, durable and can be extended to 35 cm. Equipped with safety pin attachment for maximum security, small flies holder patch and stainless steel snaps.

 Bouton de service petit et léger à ressort double. Le ressort en plastique est puissant, durable et s'allonge jusqu'à 35 cm. Equipé avec épingle de sûreté, mousse crantée accroche-mouches et agrafes en acier inox.

BUSTA DA 1 PEZZO - CONF. DA 10 BUSTE
1 PIECE PER BAG - PACK SIZE 10 BAGS

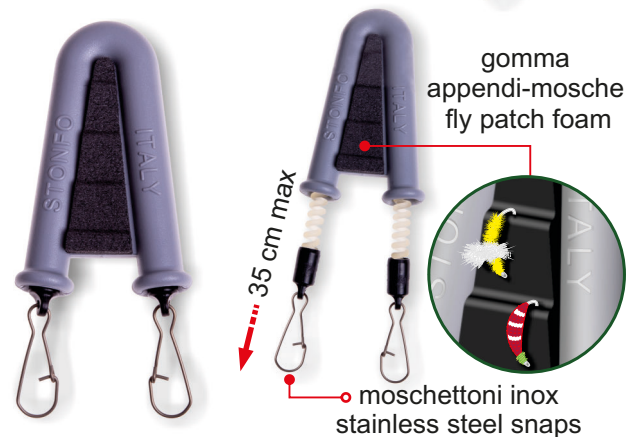

Art.622 BOTTON SERVICE MINI

Ø 9,5 x 27 mm

 Bottone di servizio di dimensioni molto compatte munito di magneti di grande potenza. Ideale per appendere, pronti all'uso, piccoli accessori come taglia-filo, slamatore etc. sia al gilet che alla collana.

 Very compact tool holder, with strong magnets. Ideal to hold on the vest, ready to use, small accessories like line-cutter, disgorgor etc.

 Bouton de service très compact avec des aimants de forte puissance. Permet d'accrocher, prêt à l'emploi, les petits accessoires tels que coupe-fil, dégorgeoir etc.

BUSTA DA 1 PEZZO - CONFEZIONE DA 5 PEZZI
1 PIECE PER BAG - PACK SIZE 5 PIECES

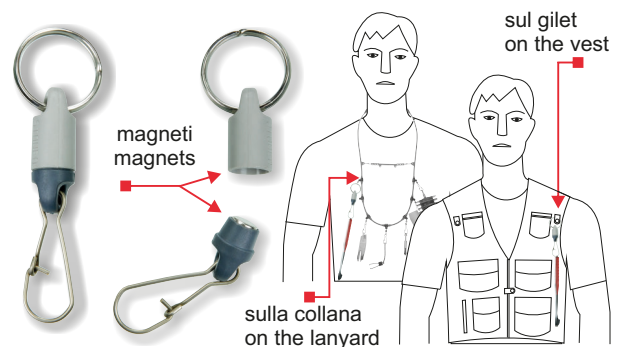

Art.520 BOTTON SERVICE MAGNETICO

 *Bottono di servizio con forti magneti per appendere pronto all'uso il guadino, il raffietto o altri accessori. La molla in materiale plastico durevole ha una buona potenza e si estende fino a cm 130.*

 *Retractor with strong magnets for holding net, small gaff or other accessories. The plastic spring is powerful, durable and can be extended to 130 cm.*

 *Bouton de service avec forts aimants pour attacher une époussette, une gaffe légère ou d'autres accessoires. Le ressort en plastique est puissant, durable et s'allonge jusqu'à 130 cm.*

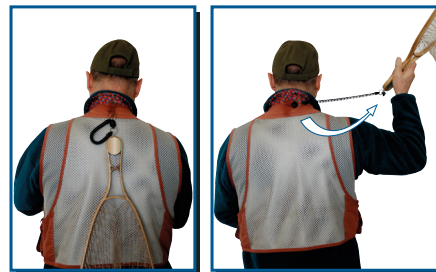



BUSTA DA 1 PEZZO - CONFEZIONE DA 5 PEZZI
1 PIECE PER BAG - PACK SIZE 5 PIECES

Art.603 COLLANA STONFO

FISHING NECK LANYARD

 *Collana ultraleggera, molto resistente e confortevole. Stampata in gomma è munita di sei moschettoni inox di forma arrotondata per tenere a portata di mano vari accessori tipo slamatori, asciuga mosche, taglia filo, ago etc. Una speciale clip permette di assicurare la collana bloccandola alla cintura o alla camicia. Gli accessori non sono inclusi. Lunghezza 105 cm.*

 *Ultralight and very strong fishing neck lanyard. Moulded in comfortable rubber it has six rounded stainless steel snaps ideal to attach essential accessories like disgorgers, floatant, snips, needle etc. Equipped with a special clip to secure the lanyard to the shirt or pants. Accessories not included. Length 105 cm.*

 *Collier ultra léger, très résistant et confortable. Matricé en caoutchouc il est composé de six agrafes de forme arrondie en acier inox pour avoir à portée de main ce dont vous avez toujours besoin comme dégorgeoirs, sèche-mouches, coupe-fil, aiguille etc. Il est muni de clip spécial qui se pince à la ceinture ou à la chemise pour éviter le balancement. Les accessoires ne sont pas fournis. Longueur 105 cm.*





clip di bloccaggio
clip to prevent swinging

BUSTA DA 1 PEZZO - CONFEZIONE DA 5 PEZZI
1 PIECE PER BAG - PACK SIZE 5 PIECES

Art.642 LENTE A VENTOSA

MAGNIFYING GLASS WITH SUCTION CUP BASE

 *Lente d'ingrandimento di alta qualità, consente di vedere chiaramente e senza distorsioni piccoli particolari. Il braccio flessibile ha una potente base a ventosa con azionamento a leva per garantire un rapido e sicuro bloccaggio. Dati tecnici: ingrandimento 2X, dimensioni lente 80 mm, lunghezza braccio flessibile 350 mm, peso gr 165.*

 *High quality magnifying glass, allows to clearly see small details without distorsions. The flexible arm has a powerful suction cup base with lever device to guarantee a quick and stable locking. Technical data: 2X magnification, lens dimensions 80 mm, length of flexible arm 350 mm, weight 165 gr*

 *Loupe d'haute qualité, vous permet de voir clairement et sans distorsions petits détails. Le bras flexible est équipé d'une puissante base à ventouse avec dispositif à levier pour garantir un blocage rapide et stable. Données techniques: grossissement par 2, dimensions loupe 80 mm, bras flexible de 350 mm long, poids gr 165.*



CONFEZIONE DA 1 PEZZO - PACK SIZE 1 PIECE

Art.524 REALISTIC EGGS

 *Imitazioni realistiche di uova di trota e salmone, realizzate in materiale morbido traslucido altamente adescante. Si applicano direttamente sull'amo sia singolarmente che a grappolo o per mezzo del blocca esca art.139.*

 *Attractor soft translucent beads that imitate the trout and salmon eggs. Fix one or more beads directly on the hook or by the bait holder item 139.*

 *Perles imitation d'œufs de poisson en matériau souple translucide à utiliser directement sur l'hameçon seul, en chapelet ou par l'art. 139 bloque esche.*

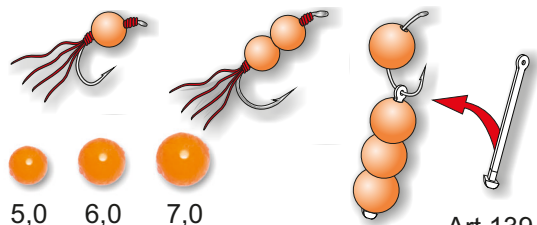

Mis Ø ext 5,0 6,0 7,0

BUSTA DA 20 PERLINE - CONFEZIONE DA 10 BUSTE
20 BEADS PER BAG - PACK SIZE 10 BAGS

Art.139
Bait holder

HOLO LURE EYES





Art.511 Misure piccole
Small sizes

Art.512 Misure grandi
Big sizes





 *Occhi adesivi lenticolari olografici per la costruzione e personalizzazione di esche artificiali.*

 *Holographic adhesive lure eyes.*

 *Yeux autocollants lenticulaires holographiques pour leurres.*

Colori Colours	   
	Bianco Rosso Oro Verde White Red Gold Green
Small Sizes	Ø mm 2,0 -2,5 -3,0 -3,5 -4,0 -5,0

BUSTA DA 24 PEZZI - 24 PIECES PER BAG

Colori Colours	   
	Bianco Rosso Oro Verde
Big Sizes	Ø mm 7,0 - 9,0 - 12,0

BUSTA DA 12 PEZZI - 12 PIECES PER BAG

CONFEZIONE DA 10 BUSTE - PACK SIZE 10 BAGS

FLUO LURE EYES

Art.538 Misure piccole
Small sizes

Art.539 Misure grandi
Bigl sizes

 Occhi adesivi lenticolari fluorescenti ottimi per la costruzione e personalizzazione di esche artificiali.

 Fluorescent adhesive lure eyes. Suitable to customize your lures.

 Yeux autocollants lenticulaires fluo pour leurres. Idéaux pour la personnalisation des leurres.

CONFEZIONE DA 10 BUSTE - PACK SIZE 10 BAGS

Colori Colours	 Arancio Fluo Fluo Orange Giallo Fluo Fluo Yellow
Small Sizes	Ø mm 2,0 -2,5 -3,0 -3,5 -4,0 -5,0

BUSTA DA 24 PEZZI - 24 PIECES PER BAG

Colori: Arancio Giallo	
Big Sizes	Ø mm 7,0 - 9,0 - 12,0

BUSTA DA 12 PEZZI - 12 PIECES PER BAG

Art.601 SYNTHETIC FILM

SILVER HOLO		IRIDESCENT BLUE		IRIDESCENT PINK	
-------------	---	-----------------	---	-----------------	---

 Pellicola olografica e iridescente per la realizzazione di esche artificiali. Prodotta in tre colori. Dim. 55x135 mm.



 Holographic and iridescent film can be used for many types of lures. Available in three colours. Dim. 55x135 mm.

 Pellicule holographique et iridescente pour la réalisation des leurres. Produite en trois couleurs. Dim. 55x135 mm.

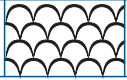

BUSTA DA 2 FOGLI - CONFEZIONE DA 10 BUSTE * 2 SHEETS PER BAG - PACK SIZE 10 BAGS

Art.513 3D FISHSCALE ADHESIVE TAPE

Mis Sizes	Small		Big	
Colori Colours	Bianco White	Rosso Red	Oro Gold	Verde Green

 Film adesivo olografico con squame in rilievo per la personalizzazione di esche artificiali.

 Holographic adhesive tape with relief fishscales.

 Autocollant holographique avec écailles in relief pour la personnalisation des leurres.

BUSTA DA 2 FOGLI - CONFEZIONE DA 10 BUSTE
2 SHEETS PER BAG - PACK SIZE 10 BAGS

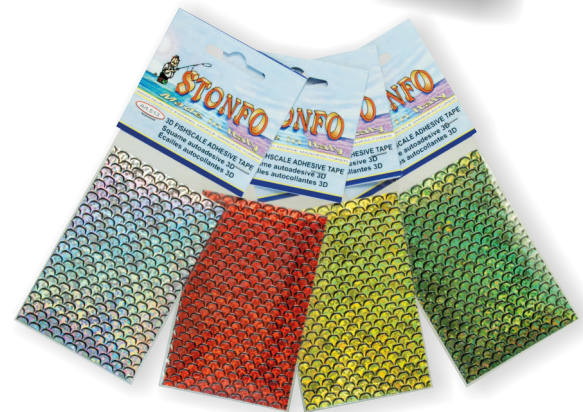

Art.540 LIVREA FLUO ADHESIVE TAPE

 Disegno decorativo stampato in rilievo su supporto fluorescente adesivo utile per la personalizzazione di esche artificiali. 2 colori.

 Relief pattern printed on fluorescent adhesive tape. Suitable to customize your lures. 2 colours.

 Dessin décoratif imprimé en relief sur autocollant fluorescent. Idéal pour la personnalisation des leurres. 2 couleurs.

BUSTA DA 2 FOGLI - CONFEZIONE DA 10 BUSTE
2 SHEETS PER BAG - PACK SIZE 10 BAGS

Arancio fluorescente
Fluo Orange 57X93 mm

Giallo fluorescente
Fluo Yellow 57X93 mm





HOLO FISH

Art.534 Mis.1 dim.57x93 mm

Art.535 Mis.2 dim.85x138 mm

 Disegno di pesciolino stampato in rilievo su supporto olografico adesivo argentato utile per la personalizzazione di esche artificiali. 2 misure.

 Relief fish printed on holographic silver adhesive tape. Suitable to customize your lures. 2 sizes.

 Dessin de poisson imprimé en relief sur autocollant holographique argenté. Idéal pour la personnalisation des leurres. 2 tailles.

BUSTA DA 2 FOGLI - CONFEZIONE DA 10 BUSTE
2 SHEETS PER BAG - PACK SIZE 10 BAGS



Art.600 **SYNTHETIC WINGS**



Colours: **BLUE HOLO** **RED HOLO** **RAINBOW HOLO** **IRIDESCENT**

Alucce leggere e flessibili ottime per la realizzazione di sabiki e streamers. Sono stampate su pellicola sintetica ad alta resistenza con effetto olografico o iridescente. Ogni ala ha il profilo pretagliato ed è pronta all'uso. Disponibili in tre grandezze e quattro colori.

Synthetic wings. Light and flexible, are fantastic on sabiki and streamers. Printed on holographic or iridescent syntetic film, each wing outline is die-cut ready to use. Available in three sizes and four colours.

Ailes légères et flexibles idéales pour la réalisation de sabiki et streamers. Elles sont imprimées sur pellicule holographique ou iridescente et chaque aile est poinçonnée prêt à l'emploi. Produites en trois tailles et quatre couleurs.

BUSTA DA 12 ALUCCE-CONFEZIONE DA 10 BUSTE * 12 WINGS PER BAG - PACK SIZE 10 BAGS

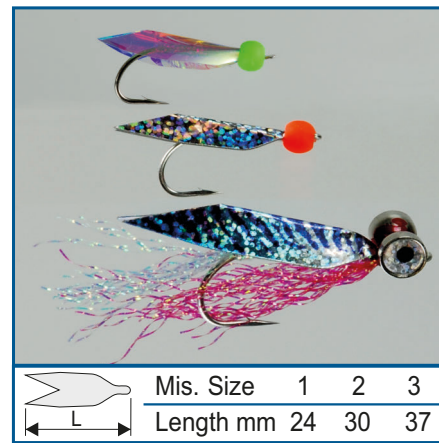

Art.625 **FOAM STRIKE INDICATORS**

Indicatori d'abboccata in foam adesiva di colore giallo e arancio fluorescente. Di facile applicazione e posizionamento sul finale. Confezione colori assortiti.

Strike indicators in fluorescent yellow and orange adhesive foam. Easy to apply and repositionable on the tippet. Packet in miscellaneous colours.

Indicateurs de touche en foam adhésif jaune et orange fluorescent. Facile à appliquer sont repositionnables sur le bas de ligne. Sachet couleurs assorties.

**BUSTA DA 20 PEZZI - CONFEZIONE DA 10 BUSTE
20 PIECES PER BAG - PACK SIZE 10 BAGS**

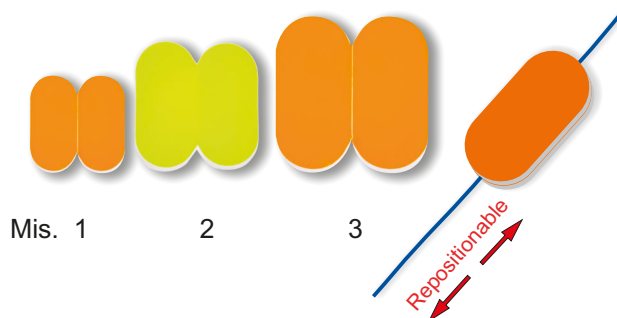

Art.186 **SEGNAFILO LINE SIGNAL - GUIDE FIL**

Mis. 1	Mis. 2	Mis. 3
Ømm 5	mm 8	mm 11

Segnafilo ideale per la pesca alla trota in torrente nei colori giallo e rosso fluorescente. Disponibile in 3 diverse misure.

Line signal for stream trout in yellow and red fluorescent colours. Available in 3 sizes.

Guide-fil indicateur pour la pêche de la truite en torrent. Couleurs fluo jaune et rouge. 3 tailles.



**BUSTA DA 6 PEZZI - CONFEZIONE DA 10 BUSTE
6 PIECES PER BAG - PACK SIZE 10 BAGS**

Art.378 **SEGNAFILO INTERCAMBIABILE
INTERCHANGEABLES LINE SIGNAL**

Segnafilo intercambiabile ideale per la pesca alla trota in torrente nei colori giallo e rosso fluorescente. Disponibile in 3 diverse misure.

Interchangeable line signal for stream trout in yellow and red fluorescent colours. Available in 3 sizes.

Guide-fil indicateur pour la pêche de la truite en torrent. Modèle interchangeable. Couleurs fluo jaune et rouge. 3 tailles.

**BUSTA DA 6 PEZZI - CONFEZIONE DA 10 BUSTE
6 PIECES PER BAG - PACK SIZE 10 BAGS**

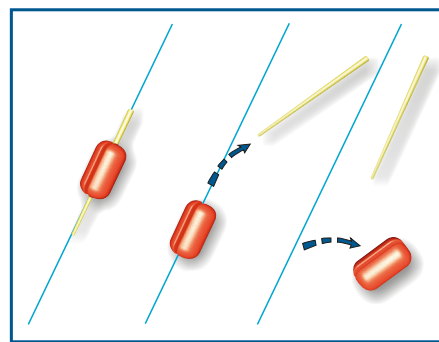
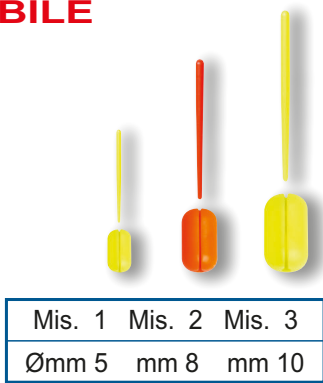

Art.631 **MAGNETIC ROD HOLDER**

Piccolo accessorio in gomma morbida con magnete integrato, permette il fissaggio temporaneo della canna all'autovettura o a qualsiasi superficie metallica. Utilissimo durante la fase di preparazione alla pesca, evita che la canna possa cadere a terra.

Small soft rubber accessory with a magnet inside, it holds the fishing rod on the car or any metallic surface. Very useful to keep fishing rod in a safe and secure position while preparing the fishing equipment.

Petit accessoire en caoutchouc souple avec aimant intégré, permet la fixation temporaire de la canne à la voiture ou à toutes les surfaces métalliques. Très utile pendant la phase de préparation de la pêche, empêche à la canne de tomber au sol.

BUSTA DA 2 PEZZI - CONF. DA 10 BUSTE * 2 PIECES PER BAG - PACK SIZE 10 BAGS

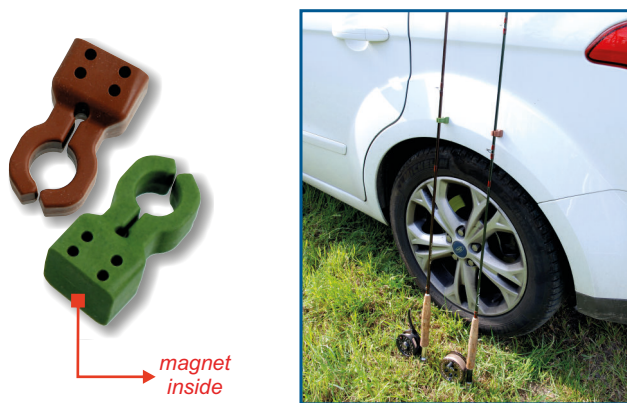

Art.272 FULL STOP

 Per bloccare rapidamente sulla lenza piombi ed altri accessori scorrevoli. Ideale per la pesca alla trota, bolentino e surf casting.

 Quick stopper to fix the sinkers or other sliding accessories on the fishing line. Ideal for trout fishing, boat fishing and surf casting.

 Pour bloquer rapidement tous les lests, plombs et autres accessoires sur le fil.



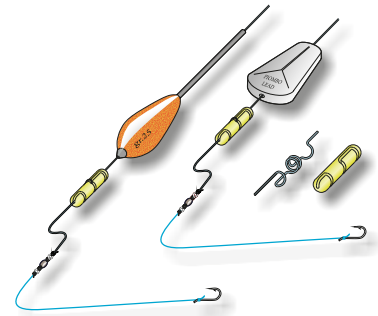

Mis. 1	Mis. 2	Mis. 3
Ø3,5x15	5x18,5	8x22



BUSTA DA 10 PEZZI - CONFEZIONE DA 10 BUSTE
10 PIECES PER BAG - PACK SIZE 10 BAGS

Art.108 AMMORTIZZATORI SPRING SHOCK ABSORBER

 Ammortizzatori a molla in acciaio inox per bombarde, strisci, piombi etc.etc.

 Spring shock absorber in stainless steel material suitable for weights, bombarda floats etc. etc.

 Ressort amortisseur en acier inox pour bombettes, plombs etc. etc.





Mis. 1	Mis. 2	Mis. 3
max 10 gr	max 25 gr	oltre - over 25 gr



BUSTA DA 10 PEZZI - CONFEZIONE DA 10 BUSTE
10 PIECES PER BAG - PACK SIZE 10 BAGS

Art.302 INFILA FILO LINE THREADER

 Per facilitare il passaggio del filo nei tubetti anti-tangle, nei piombi a striscio etc.

 For threading main line through anti-tangle tubing.

 Aiguille inox souple pour passer le fil dans les antitangles.

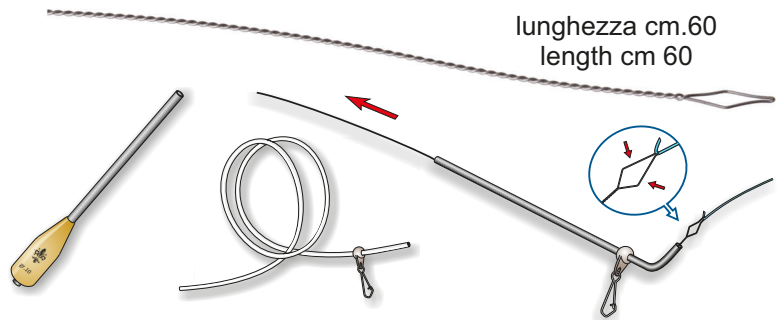



lunghezza cm.60
length cm 60

BUSTA DA 1 PEZZO - CONFEZIONE DA 10 BUSTE
1 PIECE PER BAG - PACK SIZE 10 BAGS

Art.369 INFILA BOMBARDE LINE THREADER NEEDLE

 Ago speciale sottile per agevolare il passaggio del filo nelle bombarde, nei piombi, nelle testine artificiali etc. etc. Lunghezza cm 23

 Special needle for threading main line through anti-tangle, bombarda floats, leads, lures etc. etc. Length cm 23.

 Aiguille spéciale pour passer le fil dans les bombettes, plombs, leurres etc. etc. Longueur cm 23.



BUSTA DA 1 PEZZO - CONFEZIONE DA 10 BUSTE
1 PIECE PER BAG - PACK SIZE 10 BAGS

Art.107 MOLLE PER AMI HOOK SPRINGS

 Molletta blocca esca in acciaio inox per ami. Aumenta notevolmente la tenuta sull'amo di esche quali pane, pasterello, polenta etc. etc.

 Stainless steel hook springs. Ideal for baits like bread, ground-bait, polenta etc.etc.

 Ressort inox pour hameçon. Idéal pour êches comme pain, amorce, polenta etc.



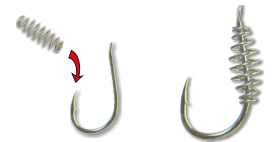

Mis. 1	2	3	4
--------	---	---	---



BUSTA DA 10 PEZZI - CONFEZIONE DA 10 BUSTE
10 PIECES PER BAG - PACK SIZE 10 BAGS

Art.574 MULTIMAGGOT

 Queste piccole clip in acciaio inox permettono di innescare diversi bigattini per creare un boccone molto catturante. Il loro bloccaggio sull'amo avviene in modo molto semplice per mezzo di un piccolo elastico fornito in due diverse lunghezze.

 Small stainless steel clips designed for the attachment of several maggots. They are easy to fix on the hook thanks to special small elastics that are supplied in two different lengths.

 Petits clips étudiés pour l'attache rapide des asticots. A fixer rapidement à l'hameçon par des élastiques spéciaux en deux longueurs.

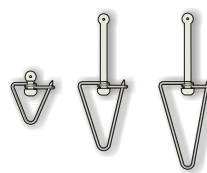

Mis. 1 2 3

aprire la clip open the clip ouvrir le clip
innescare i bigattini thread the maggots enfilez les asticots
chiudere la clip close the clip fermer le clip

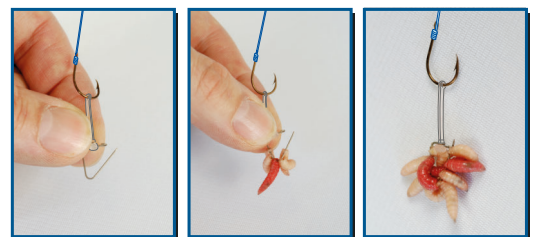

BUSTA DA 6 PEZZI - CONFEZIONE DA 10 BUSTE
6 PIECES PER BAG - PACK SIZE 10 BAGS

Art.459 PASTERELLO SOFT BAIT SPRINGS

 Mollette in acciaio inox per la pesca con il pasterello. Il loro bloccaggio sul'amo avviene in modo molto semplice per mezzo di un piccolo elastico che viene fornito in due diverse lunghezze.

 Stainless steel groundbait springs, designed to hold soft baits on the hook as paste, groundbait etc. Easy to fix thanks to small elastics that are supplied with the springs in two different lengths.

 Ressorts inox étudiés pour l'emploi des esches souples comme bouillottes d'amorce, de pain etc. A fixer rapidement à l'hameçon par des élastiques en deux longueurs livrés avec les ressorts.





Mis.1	2	3	4	5
Ømm 5,5	8	12	16	20

BUSTA DA 5 PEZZI - CONFEZIONE DA 10 BUSTE
5 PIECES PER BAG - PACK SIZE 10 BAGS

Art.721 SLIDER SNAP NEW 2020



 Attacchi scorrevoli multifunzionali prodotti in materiale plastico autolubrificante. Grazie alla loro struttura ottenuta con lavorazione dal pieno risultano leggerissimi e molto resistenti. Non alterano il lancio. Disponibili in due diverse misure.

 Multifunctional running connector, made of self-lubricating plastic material. Fully machined. Lightweight and very strong, it doesn't influence the cast. Produced in two different sizes.

 Connecteur coulissant multifonctionnel, produit en plastique autolubrifiant. Entièrement usiné. Léger et très résistant, son emploi ne modifie pas le lancer. Disponible en deux tailles.

BUSTA DA 2 PEZZI - CONF. DA 10 BUSTE * 2 PER BAG - PACK SIZE 10 BAGS

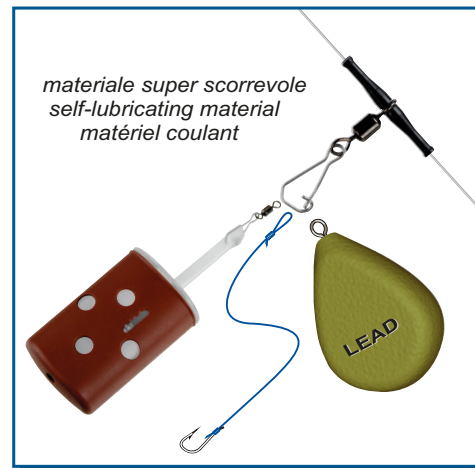

Art.620 ATTACCO ROTO ROTO CONNECTOR

 Attacco scorrevole multiuso ideale per pasturatore, piombo, finali etc. Munito di molletta in acciaio inox rotante e conetto in gomma anti-alga.

 Multipurpose running connector suitable for feeder, lead, leader, etc. Equipped with rotating stainless steel spring and anti-weed rubber cone.

 Connecteur multi-usage coulissant idéal pour amorçoir, plomb, bas de ligne, etc. Équipé de ressort rotatif en acier inox et cône en caoutchouc anti-algues.

BUSTA DA 5 PEZZI - CONFEZIONE DA 10 BUSTE
5 PIECES PER BAG - PACK SIZE 10 BAGS

Art.664 ATTACCO ROTO MAXI MAXI ROTO CONNECTOR

 Attacco scorrevole molto robusto, ideale per pasturatori e piombi di peso elevato. Munito di cono in gomma anti-alga. La molla rotante in acciaio inox funziona da ammortizzatore per prevenire rotture.

 Very strong running connector, ideal for heavy feeders and leads. Equipped with anti-weed rubber cone. The rotating stainless steel spring works as a shock absorber to prevent breakages.

 Connecteur coulissant très robuste, idéal pour amorçoirs et plombs lourds. Équipé de cône en caoutchouc anti-algues. Le ressort rotatif en acier inox fonctionne comme un amortisseur pour éviter ruptures.

BUSTA DA 3 PZ. - CONF. DA 10 BU.
3 PCS PER BAG - PACK SIZE 10 BAGS

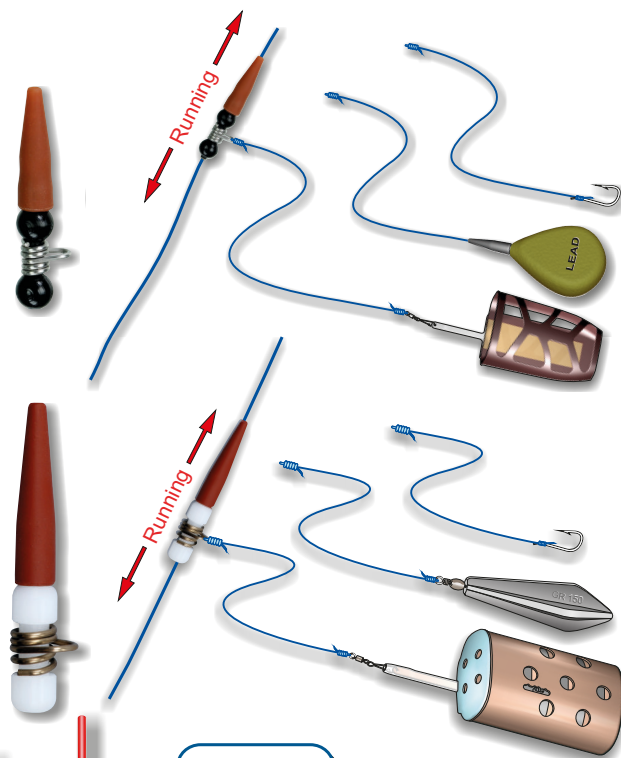



GALLEGGIANTI PASTURATORI

FEEDER FLOAT - FLOTTEUR AMORÇOIR

Art.337 Grammi 8+2 **Art.338** Grammi 15+2

 Galleggianti pasturatori studiati per la pesca di superficie. La regolazione della grandezza dei fori permette di variare la quantità di uscita delle esche.

 Feeder floats with adjustable size of the holes to ensure efficient release of all bait.

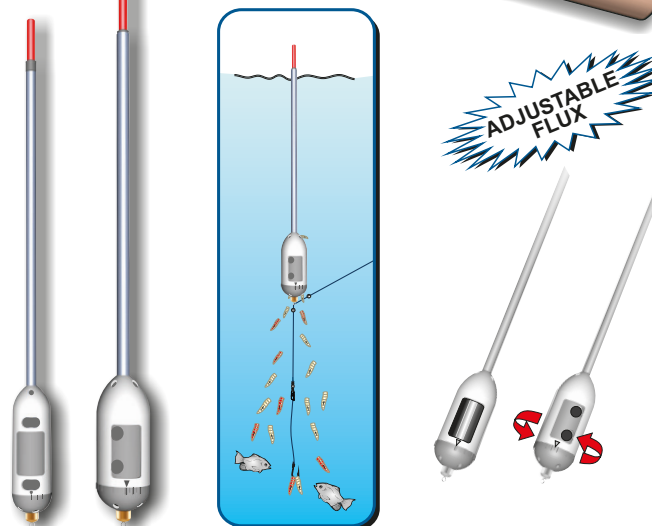

 Flotteur amorçoir avec régulation de la dimension des trous. Permet de varier le flux des asticots.

BUSTA DA 1 PEZZO - CONFEZIONE DA 10 BUSTE
1 PIECE PER BAG - PACK SIZE 10 BAGS



Art.359 **PASTURATORE SCORREVOLE PICCOLO**

SMALL SIZE SLIDING SWIMFEEDER - AMORÇOIR COULISSANT PETIT

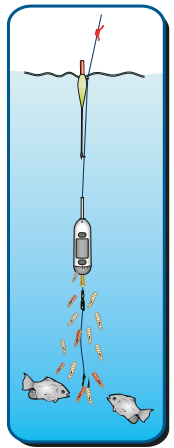

-  *Pasturatore scorrevole piccolo con regolazione della grandezza dei fori. Consente di variare il flusso delle esche.*
-  *Small sliding swimfeeder with adjustable size of the holes to ensure efficient release of all bait.*
-  *Amorçoir coulissant petit avec réglage de la dimension des trous. Permet de moduler le flux des asticots.*

BUSTA DA 1 PEZZO - CONFEZIONE DA 10 BUSTE
1 PIECE PER BAG - PACK SIZE 10 BAGS



Art.632 **PASTURATORE MINIBOMB**

MINIBOMB SWIMFEEDER



-  *Pasturatore in linea ideale per la pesca con galleggiante scorrevole. Munito di regolazione della grandezza dei fori per ritardare o accelerare l'uscita delle esche. Prodotto in tre diverse grammature gr 10 -15 -20.*
-  *In line swimfeeder perfect for fishing with sliding float. The size of the holes is adjustable to ensure efficient release of all baits. Available in three different weights gr 10 - 15- 20.*
-  *Amorçoir in-line étudié pour la pêche avec flotteur coulissant. Il est muni de réglage de la dimension des trous, permet de moduler le flux des asticots. Disponible en trois poids gr 10 - 15 - 20.*

BUSTA DA 1 PEZZO - CONF. DA 10 BUSTE
1 PIECE PER BAG - PACK SIZE 10 BAGS



Art.106 **PASTURATORE SCORREVOLE GALLEGGIANTE**

FLOATING SLIDING SWIMFEEDER - AMORÇOIR FLOTTANT COULISSANT

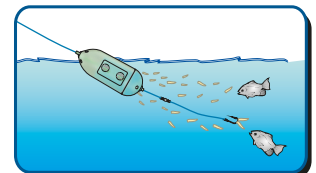
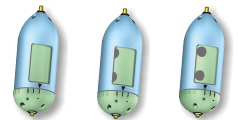
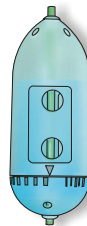

-  *Pasturatore galleggiante scorrevole. Anche se pieno di esche (circa gr 15 di bigattini) si mantiene a galla. La regolazione della grandezza dei fori consente di variare il flusso delle esche.*
-  *Floating sliding swimfeeder with adjustable size of the holes to ensure efficient release of all bait. Capacity gr 15 of maggots.*
-  *Amorçoir flottant coulissant avec réglage de la dimension des trous. Permet de moduler le flux des asticots. Capacité des asticots gr 15.*

BUSTA DA 1 PEZZO - CONFEZIONE DA 10 BUSTE
1 PIECE PER BAG - PACK SIZE 10 BAGS



Art.90 **PASTURATORE REGOLABILE SCORREVOLE**

SLIDING ADJUSTABLE SWIMFEEDER - AMORÇOIR RÉGLABLE COULISSANT

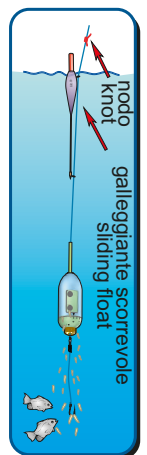
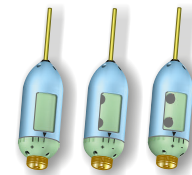
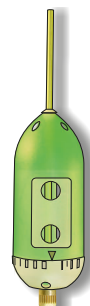

-  *Pasturatore scorrevole con regolazione della grandezza dei fori consente di variare il flusso delle esche. Fornito con 4 pesi diversi intercambiabili rapidamente.*
-  *Sliding swimfeeder with adjustable size of the holes to ensure efficient release of all bait. Supplied with 4 different interchangeable weights.*
-  *Amorçoir coulissant avec réglage de la dimension des trous. Permet de moduler le flux des asticots. Livré avec 4 poids interchangeables.*

BUSTA DA 1 PEZZO - CONFEZIONE DA 10 BUSTE
1 PIECE PER BAG - PACK SIZE 10 BAGS



Art.90-1 **PASTURATORE REGOLABILE PESANTE**

HEAVY SLIDING ADJUSTABLE SWIMFEEDER - AMORÇOIR RÉGLABLE COULISSANT

-  *Pasturatore scorrevole con regolazione della grandezza dei fori consente di variare il flusso delle esche. Fornito con pesi da 10, 25 e 40 grammi intercambiabili rapidamente.*
-  *Sliding swimfeeder with adjustable size of the holes to ensure efficient release of all bait. Supplied with interchangeable weights of 10, 25 and 40 gr.*
-  *Amorçoir coulissant avec réglage de la dimension des trous. Permet de moduler le flux des asticots. Livré avec poids interchangeables de 10, 25 et 40 gr.*

BUSTA DA 1 PEZZO - CONFEZIONE DA 10 BUSTE
1 PIECE PER BAG - PACK SIZE 10 BAGS

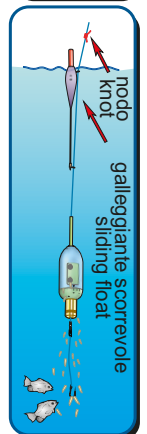
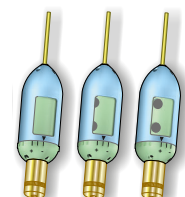

Art.88

PASTURATORE REGOLABILE DI SUPERFICIE

SURFACE ADJUSTABLE SWIMFEEDER - AMORÇOIR RÉGLABLE DE SURFACE



Pasturatore ideale per la pesca di superficie. Anche se pieno di esche (circa gr 15 di bigattini) si mantiene a galla. La regolazione della grandezza dei fori consente di variare il flusso delle esche.



Floating model swimfeeder with adjustable size of the holes to ensure efficient release of all bait. Capacity gr 15 of maggots.



Amorçoir flottant avec réglage de la dimension des trous. Permet de moduler le flux des asticots. Capacité des asticots gr 15.

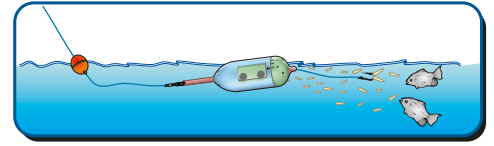
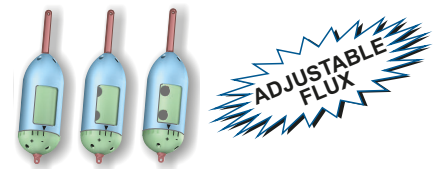

BUSTA DA 1 PEZZO - CONFEZIONE DA 10 BUSTE
1 PIECE PER BAG - PACK SIZE 10 BAGS

Art.89

PASTURATORE REGOLABILE MULTIPESO

MULTIPESO ADJUSTABLE SWIMFEEDER - AMORÇOIR RÉGLABLE



Pasturatore per la pesca a fondo con regolazione della grandezza dei fori consente di variare il flusso delle esche. Fornito con 3 pesi diversi intercambiabili rapidamente.



Swimfeeder with adjustable size of the holes to ensure efficient release of all bait. Supplied with 3 different interchangeable weights.



Amorçoir pour la pêche de fond avec réglage de la dimension des trous. Permet de moduler le flux des asticots. Livré avec poids interchangeables.

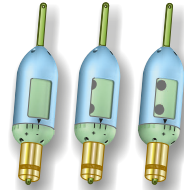

BUSTA DA 1 PEZZO - CONFEZIONE DA 10 BUSTE
1 PIECE PER BAG - PACK SIZE 10 BAGS

PASTURATORI MAXI

MAXI SWIMFEEDER



Pasturatori pesanti scorrevoli in linea. Consentono lanci a grande distanza con una buona tenuta sul fondo. Regolazione della grandezza dei fori. Fori più grandi per pastura, sarde macinate etc.etc. Buona capienza (ml 65). Alette anti-rotolamento removibili



In line heavy weight swimfeeders. Ideal for long distance feeding, they assure a good stability on the bottom. Adjustable size of the holes. Bigger holes suitable for groundbait, sardine paste etc.etc. Good capacity (ml 65). Removable fins to prevent rolling.



Amorçoirs coulissants lourds "in line". Étudiés pour les pêches à grande distance et pour courant soutenu. Réglage de la dimension des trous. Trous plus grands pour amorce, pâte de sardine etc.etc. Bonne capacité (ml 65). Ailettes antirotation démontables

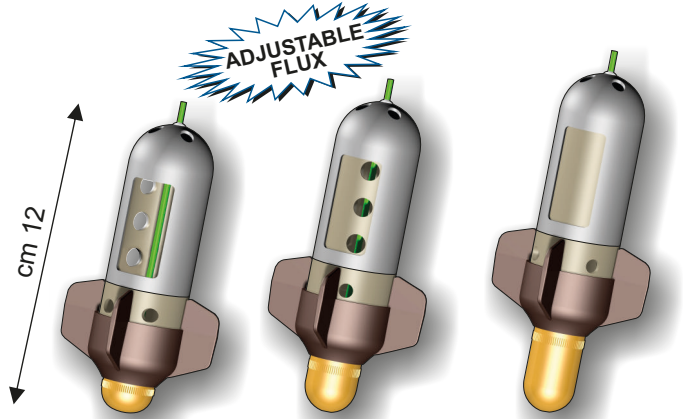

BUSTA DA 1 PEZZO - CONFEZIONE DA 10 PEZZI
1 PIECE PER BAG - PACK SIZE 10 BAGS

Art.490 gr 100 Art.491 gr 140 Art.492 gr 180

PASTURATORI LEGERING REGOLABILI

ADJUSTABLE LEGERING SWIMFEEDERS
AMORÇOIRS RÉGLABLES LEGERING



Pasturatori per la pesca a fondo con regolazione della grandezza dei fori consentono di variare il flusso delle esche.



Swimfeeders with adjustable size of the holes to ensure efficient release of all bait.



Amorçoirs pour la pêche au posé avec réglage de la dimension des trous. Permettent de moduler le flux des asticots.

Art.176	Gr 10
Art.177	Gr 20
Art.178	Gr 30
Art.179	Gr 50
Art.180	Gr 70

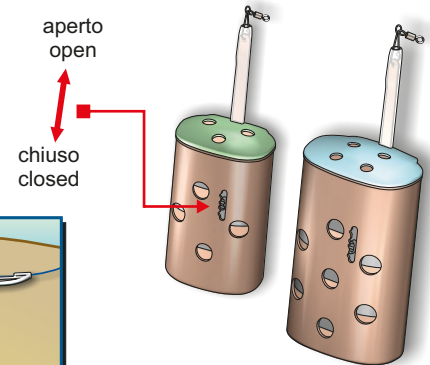
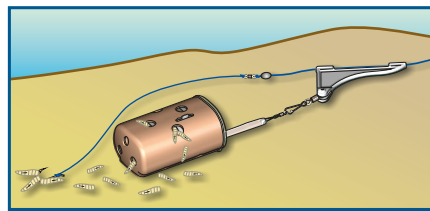

BUSTA DA 1 PEZZO - CONFEZIONE DA 10 BUSTE
1 PIECE PER BAG - PACK SIZE 10 BAGS

PASTURATORI LEGERING REGOLABILI

ADJUSTABLE SWIMFEEDERS
AMORÇOIRS LOURDS RÉGLABLES



Pasturatori pesanti per la pesca a fondo con regolazione della grandezza dei fori consentono di variare il flusso delle esche.



Heavy weight swimfeeders with adjustable size of the holes to ensure efficient release of all bait.



Amorçoirs lourds pour la pêche au posé avec réglage de la dimension des trous. Permettent de moduler le flux des asticots.

NR. ART.	GRAMMI
Art.188	Gr 90
Art.189	Gr 120
Art.190	Gr 170

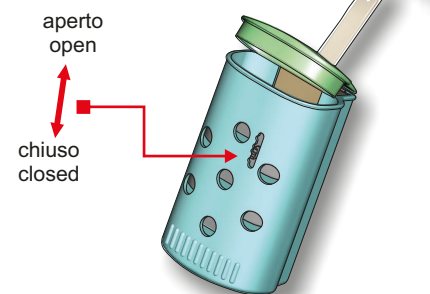



BUSTA DA 1 PEZZO - CONFEZIONE DA 10 BUSTE
1 PIECE PER BAG - PACK SIZE 10 BAGS

PASTURATORI APERTI

OPEN END SWIMFEEDERS
AMORÇOIRS OUVERTS

 Pasturatori aperti per la pesca a fondo ideali per pastura, mais, pellets etc. Disponibili in tre misure gr 10 - 20 - 30.

 Open end feeders suitable for groundbait, corn, pellets etc. Available in 3 sizes gr 10 - 20 - 30.

 Amorçoirs ouverts pour amorce, maïs, pellets etc. Disponibles en trois mesures gr 10 - 20 - 30.

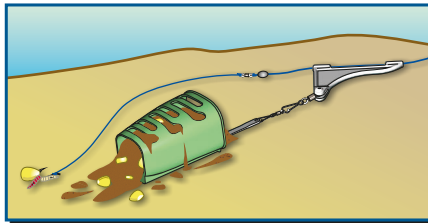

Art.193 Gr 10

Art.194 Gr 20

Art.199 Gr 30

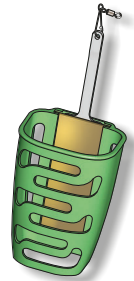



BUSTA DA 1 PEZZO - CONFEZIONE DA 10 BUSTE
1 PIECE PER BAG - PACK SIZE 10 BAGS

PASTURATORE APERTO MAXI

MAXI OPEN END SWIMFEEDERS

 Pasturatori aperti grandi per la pesca a fondo adatti per pastura, bigattini etc. Ideali per grandi fiumi e mare. Disponibili in tre misure gr 30 - 50 - 70.

 Big sizes open end feeders suitable for groundbait, maggots etc. Ideal for big rivers and sea. Available in 3 sizes gr 30 - 50 - 70.

 Amorçoirs ouverts de grande taille pour amorce, asticots etc. Indiqués pour grands fleuves et mer. Disponibles en trois mesures gr 30 - 50 - 70.

NR. ART.	GRAMMI
Art.507	Gr 30
Art.508	Gr 50
Art.509	Gr 70

BUSTA DA 1 PEZZO - CONFEZIONE DA 10 BUSTE
1 PIECE PER BAG - PACK SIZE 10 BAGS

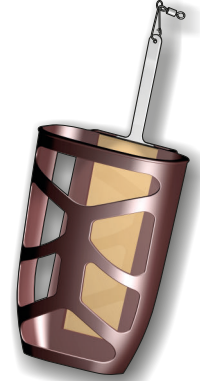

Art.720 ANTI TANGLE MICRO NEW 2020



 Anti-tangle di dimensioni estremamente ridotte, prodotti in materiale plastico autolubrificante. Grazie alla loro struttura ottenuta con lavorazione dal pieno risultano leggerissimi e molto resistenti. Ideali per il feeder e la pesca da competizione. Non alterano il lancio. Prodotti in due diverse misure.

 Very small anti-tangle, made of self-lubricating plastic material. Ideal for feeder and match fishing. Fully machined. Lightweight and very strong, it doesn't influence the cast. Produced in two different sizes.

 Anti-émmeleur extrêmement petit, produit en plastique autolubrifiant. Idéal pour la pêche au feeder et de compétition. Entièrement usiné. Léger et très résistant, son emploi ne modifie pas le lancer. Disponible en deux tailles.

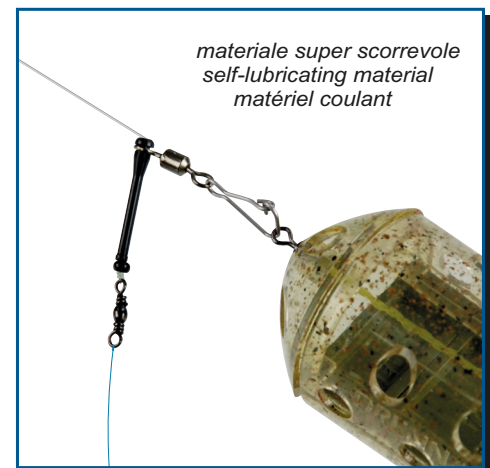



materiale super scorrevole
self-lubricating material
matériel coulant

BUSTA DA 2 PEZZI - CONF.DA 10 BUSTE
2 PER BAG - PACK SIZE 10 BAGS

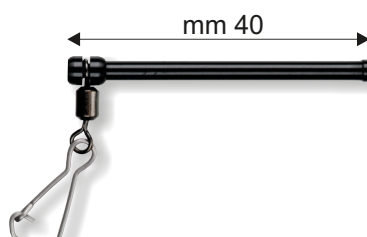
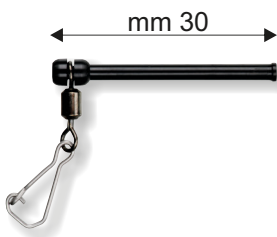
Art.713 ANTI TANGLE LIGHT NEW 2020



 Anti-tangle ideali per il feeder e la pesca da competizione. Grazie alla loro struttura ottenuta con lavorazione dal pieno risultano leggeri e molto resistenti. Non alterano il lancio. Prodotti in due diverse misure.

 Anti-tangle ideal for feeder and match fishing. Fully machined. Lightweight and very strong, it doesn't influence the cast. Produced in two different sizes.

 Anti-émmeleur idéal pour la pêche au feeder et de compétition. Entièrement usiné. Léger et très résistant, son emploi ne modifie pas le lancer. Disponible en deux tailles.



BUSTA DA 2 PEZZI - CONF.DA 10 BUSTE
2 PER BAG - PACK SIZE 10 BAGS

Art.73 ANTI TANGLE RIGIDI

RIGID ANTI TANGLE

 Anti-Tangle di alta qualità munito di boccole anti-usura.

 High quality Anti-Tangle with self-lubricating material bushes.

 Anti-Tangle d'haute qualité avec les extrémités en matériel autolubrifiant.

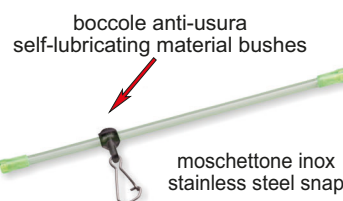

boccole anti-usura
self-lubricating material bushes

moschettone inox
stainless steel snap

Mis.	lunghezza
1	cm 5
2	cm 10
3	cm 15
4	cm 25

BUSTA DA 2 PEZZI - CONF. DA 10 BU. * 2 PIECES PER BAG - PACK SIZE 10 BAGS

Art.74 ANTI TANGLE RIGIDI CURVI
RIGID ANGLED ANTI TANGLE

- Anti-Tangle curvo di alta qualità munito di boccole anti-usura.
- High quality angled Anti-Tangle with self-lubricating material bushes.
- Anti-Tangle coudé d'haute qualité avec les extrémités en matériel autolubrifiant.

BUSTA DA 2 PEZZI - CONF. DA 10 BU. * 2 PIECES PER BAG - PACK SIZE 10 BAGS

boccole anti-usura
self-lubricating material bushes



Mis.	lunghezza
1	cm 5
2	cm 10
3	cm 15
4	cm 25

Art.362 ANTI TANGLE METALLO **STAINLESS STEEL ANTI TANGLE**

- Anti-Tangle in acciaio inox. Struttura resistentissima con boccole in nylon salvafilo.
- Stainless steel Anti-Tangle with nylon bushes. Very strong.
- Anti-Tangle en acier inox avec tulipes en nylon. Très résistant.

BUSTA DA 2 PEZZI - CONF. DA 10 BU. * 2 PIECES PER BAG - PACK SIZE 10 BAGS



Mis.	lunghezza
1	cm 5
2	cm 10
3	cm 15
4	cm 20
5	cm 25

Art.485 ANTI TANGLE METALLO MAXI
STAINLESS STEEL ANTI TANGLE MAXI

- Anti-Tangle in acciaio inox. Struttura resistentissima con boccole in nylon salvafilo. Tubetto di diametro maggiorato.
- Stainless steel Anti-Tangle with nylon bushes. Very strong. Bigger diameter tube.
- Anti-Tangle en acier inox avec tulipes en nylon. Très résistant. Tube de grand diamètre.

BUSTA DA 2 PEZZI - CONF. DA 10 BU. * 2 PIECES PER BAG - PACK SIZE 10 BAGS



Mis.	lunghezza
1	cm 5
2	cm 10
3	cm 15

BUSTA DA 2 PEZZI - CONF. DA 10 BU.
2 PIECES PER BAG - PACK SIZE 10 BAGS

Art.83 SUPER BOOMS

- Antitangle scorrevoli resistentissimi. Prodotti in due misure. La girella con moschettone è montata su un perno in acciaio inox per una totale libertà di rotazione.
- Strong booms complete with snap swivel to prevent tangles. Available in two sizes.
- Coulisseau anti-emmêleur extra fort avec émerillon et agrafe pour un bon dégagement du fil. Deux tailles.

BUSTA DA 2 PEZZI - CONF. DA 10 BU.
2 PIECES PER BAG - PACK SIZE 10 BAGS

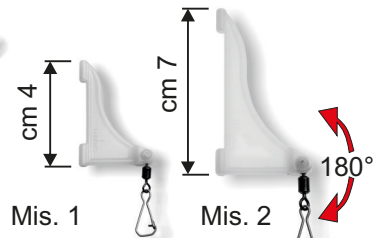
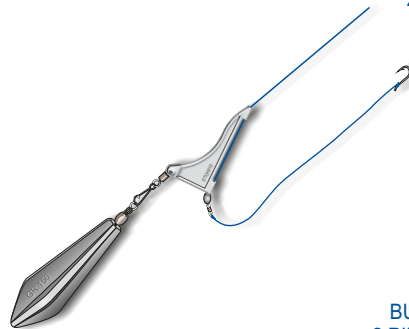

BUSTA DA 2 PEZZI - CONF. DA 10 BU.
2 PIECES PER BAG - PACK SIZE 10 BAGS

Art.230 SEA BOOMS

- Antitangle scorrevoli resistentissimi ideali per l'attacco del piombo o del pasturatore pesante. Si applicano alla lenza senza tagliare il filo. La girella con moschettone è montata su un perno in acciaio per una totale libertà di rotazione. Prodotti in due diverse misure.
- Very strong booms with snap swivel to prevent tangles. Suitable for surf-casting and feeder fishing. No need cut the line to attach or remove. Produced in two different sizes.
- Coulisseau anti-emmêleur extra fort avec émerillon et agrafe pour un bon dégagement du fil. Mise en place sur la ligne sans couper le fil. Deux tailles.

BUSTA DA 1 PEZZO - CONF. DA 10 BU. * 1 PIECE PER BAG - PACK SIZE 10 BAGS

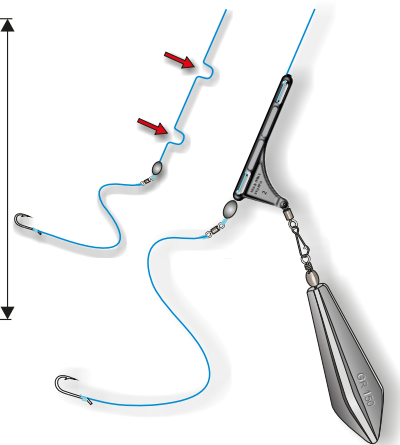
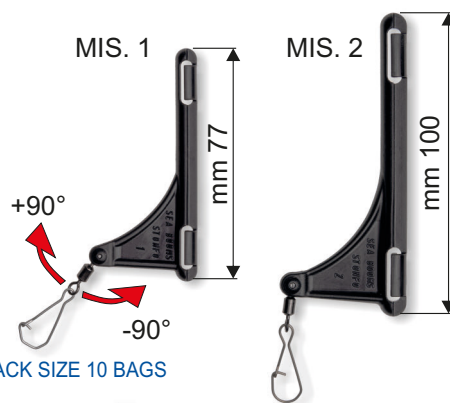

BUSTA DA 3 PEZZI - CONF. DA 10 BU.
3 PIECES PER BAG - PACK SIZE 10 BAGS

Art.261 ATTACCO JOLLY **JOLLY CONNECTOR**

- L'Attacco Jolly viene utilizzato come portapasturatore o portapiombo. Nel drifting come portagalleggiante o palloncino. Ottimo anche per il beach legering ed il carp fishing.
- Quick change beads, for quick change of feeders, leads etc.
- Système pour fixation en dérive de swim feeder, plombs etc.

BUSTA DA 10 PEZZI - CONF. DA 10 BU.
10 PIECES PER BAG - PACK SIZE 10 BAGS

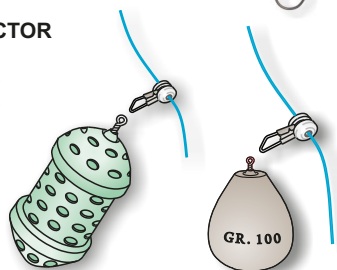

Art.71 PERLE DI POTENZA
BOOM BEADS - PERLES DE POTENCE

Art.72 PERLE DI POTENZA CON MOSCHETTONE

- Perle di potenza con moschettone di acciaio inossidabile.
- Boom beads with stainless steel safety snap.
- Perles de potence avec agrafe en inox.

BUSTA DA 5 PEZZI - CONF. DA 10 BU.
5 PIECES PER BAG - PACK SIZE 10 BAGS



Art.544 **IMBOBINATORE** SPOOLING STATION

 Imbobinatore professionale manuale adatto per ogni tipo di bobina fino ad un diametro max di 20 cm. Munito di doppia molla per una regolazione ottimale della tensione del filo. Indispensabile per caricare il filo sulla bobina del mulinello, trasferire il filo da bobina a bobina per nylon dispenser, effettuare lavori come la preparazione di finali, calamanti etc. etc.

 Professional manual Spooling Station suitable for every type of bobbin up to 20 cm of diameter. Equipped with double spring for a perfect adjustment of the line tension. Useful to spool the line on the reel, transfer the line from the bobbin to the nylon dispenser bobbins, make various types of rigs.

 Station de bobinage professionnelle manuelle idéale pour tous les types de bobines jusqu'à 20 cm de diamètre. Munie de double ressort pour régler parfaitement la tension du fil. Indispensable pour charger le fil sur la bobine du moulinet, transférer le fil sur les bobines du nylon dispenser, réaliser différents montages.

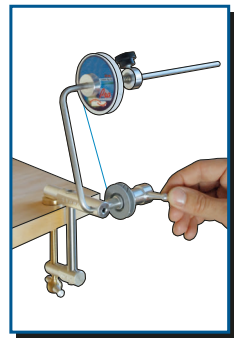
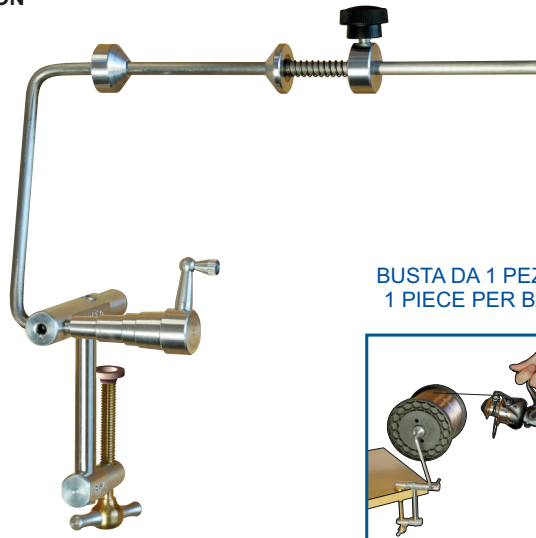

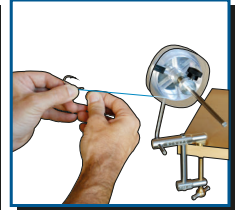
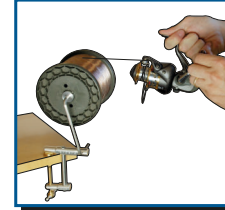

BUSTA DA 1 PEZZO
1 PIECE PER BAG



Art.467 **UNDER SIZE NEEDLES**

 Aghi di dimensione estremamente ridotta, sono ottimi per costruire cappi o congiungere il monofilo con i trecciati tubolari tipo lead core. Utilissimi anche per innescare sull' hair rig esche piccolissime o particolarmente fragili.

 Very small size needles suitable for splice loops or join monofilament lines to lead core. Ideal for hair rigging with very small or delicate bait.

 Aiguilles très petites étudiées pour la réalisation des boucles ou pour joindre la ligne au lead core. Idéales aussi pour créer des cheveux avec des appâts très petits ou très fragiles.

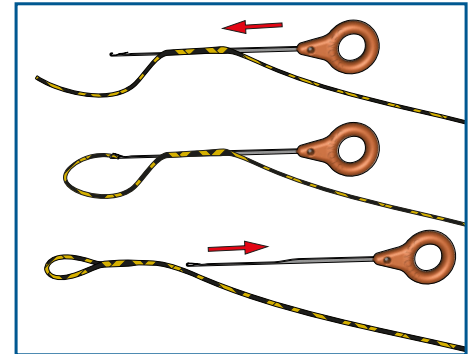

BUSTA DA 2 PZ - CONF. DA 10 BUSTE * 2 PCS PER BAG - PACK SIZE 10 BAGS

Art.295 **AGO PER BOILIES** BOILIE NEEDLE - AIGUILLE À BOUILLETES



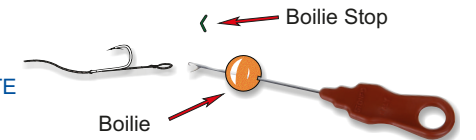

BUSTA DA 1 PEZZO - CONFEZIONE DA 10 BUSTE
1 PIECE PER BAG - PACK SIZE 10 BAGS



Art.652 **NEEDLES SET**

 Aghi ideali per la realizzazione di asole su trecciati tubolari o calzette. La confezione comprende due diverse misure.

 Needles suitable to produce loops on tubular braided line. The packaging includes two different sizes.

 Aiguilles idéales pour la réalisation des boucles sur fil tressé tubulaire. Le conditionnement comprend deux tailles différentes.

BUSTA DA 2 AGHI - CONF. DA 10 BUSTE * 2 NEEDLES PER BAG - PACK SIZE 10 BAGS

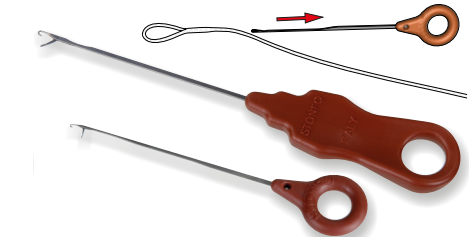

Art.682 **NEEDLE XXL 110**

 Ago con stelo in acciaio lungo mm 110 con chiusura a paletta, ideale per la realizzazione di stringers o per infilare il terminale direttamente all'interno di stick in pva. L'impugnatura dell'ago è di forma ergonomica con inserto in gomma anti-scivolo.

 Needle with 110 mm steel shaft and hinged gate closure, it is ideal to create stringers or to thread the hooklink in the pva sticks. Its ergonomic handle is in anti slip rubber.

 Aiguille avec tige en acier inox de longueur mm 110 avec chas rabattable, idéale pour la réalisation des stringers ou pour enfiler le bas de ligne directement à l'intérieur de sacs en pva. La poignée ergonomique de l'aiguille est en caoutchouc anti-dérapant.

BUSTA DA 1 PEZZO - CONFEZIONE DA 10 BUSTE * 1 PIECE PER BAG - PACK SIZE 10 BAGS



Art.308 **FORA BOILIES** BOILIES DRILL - PERCE BOUILLETES



Punta ø 1,5 mm
Drill ø 1,5 mm
Pointe ø 1,5 mm

BUSTA DA 1 PEZZO - CONFEZIONE DA 10 BUSTE
1 PIECE PER BAG - PACK SIZE 10 BAGS

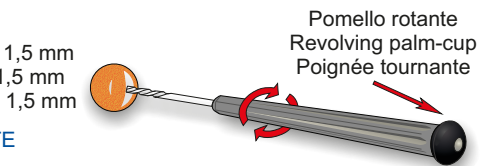

Art.254 **TRAPANO FORA ESCE Ø 6 MM** BAIT DRILL Ø 6 MM - PERCE BOUILLETES Ø 6 MM

 Trapano per forare le esche più dure tipo tiger nuts, pellets, boilies etc. Impugnatura in gomma.

 Bait drill for hard baits like tiger nuts, pellets, boilies etc. Anti-slip handle.

 Perce bouillettes dures, tiger nuts, pellets etc.etc. Poignée en gomme anti-glisement.



BUSTA DA 1 PEZZO - CONFEZIONE DA 10 BUSTE
1 PIECE PER BAG - PACK SIZE 10 BAGS

Art.238 PUNZONI FORABOILIES

BOILIE PUNCH - CREUSE BOUILLETTES

- Punzoni foraboilies con impugnatura anatomica in gomma e tagliente in metallo. Muniti di pistoncino estrattore.
- Boilie punch with rubber handle , ejector pin and sharp metal tube.
- Creuse bouillettes avec poignée anatomique en caoutchouc, piston extracteur et tube en métal tranchant.

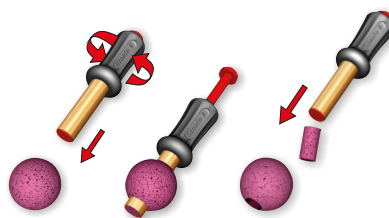

Mis. 1	2	3
mm Ø 6	Ø 8	Ø 10

BUSTA DA 1 PEZZO - CONFEZIONE DA 10 BUSTE * 1 PIECE PER BAG - PACK SIZE 10 BAGS

Art.294 BLOCCA BOILIES "V" BOILIES STOP - STOP BOUILLETTES

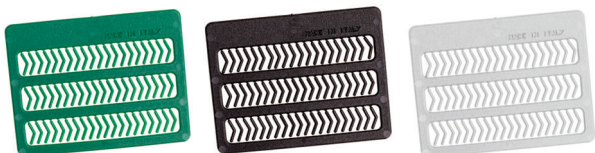

Verde-Green Nero-Black Trasparente-Clear

non servono forbici
no scissors required

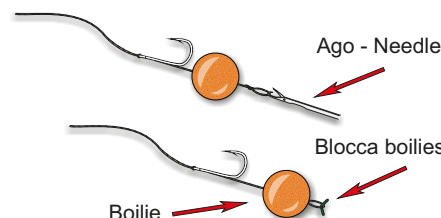

BUSTA DA 60 PEZZI - CONFEZIONE DA 10 BUSTE
60 PIECES PER BAG - PACK SIZE 10 BAGS

Art.296 BLOCCA BOILIES "S" BOILIES STOP - STOP BOUILLETTES



Verde-Green Nero-Black Trasparente-Clear

non servono forbici
no scissors required

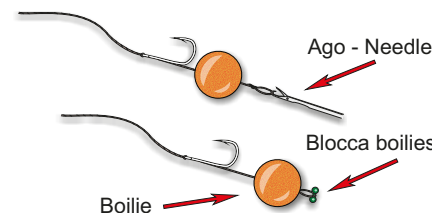

BUSTA DA 114 PEZZI - CONFEZIONE DA 10 BUSTE
114 PIECES PER BAG - PACK SIZE 10 BAGS

Art.702 BAIT SPIKE

- Spilli in materiale plastico rigido da inserire in boilies morbide, pellets, mais, esche siliconiche etc. permettendone così il loro fissaggio diretto all'hair rig. La loro leggerezza li rende indicati anche per l'utilizzo con esche galleggianti. Gli ardiglioni da entrambi i lati garantiscono una migliore tenuta dell'esca.
- Pins in rigid plastic material, can be inserted into soft boilies, pellets, corn, silicone baits etc. allowing them to be fixed directly to the hair rig. Thanks to their lightweight are perfect even for floating baits. The barbs in both sides ensure a better bait holding.
- Épingles en matériau plastique, elles peuvent être insérées dans boilies souples, pellets, maïs, appâts en silicone, etc. en permettant de les fixer directement à le montage cheveux. Leur légèreté les rend indiquées aussi pour appâts flottants. Les barbes des deux côtés garantissent une meilleure tenue de l'appât.



Mis.1 length 7-10 mm



Mis.2 length 13-17 mm

BUSTA DA 12 PEZZI - CONFEZIONE DA 10 BUSTE
12 PER BAG - PACK SIZE 10 BAGS

Art.728 PELLET STOPPER



Mis. Size	1	2	3
Length mm	4	7	10

- Studiati per bloccare pellets e boilies. Prodotti in 3 diverse misure adeguate ai diversi tipi di esca. Colore mimetico.
- Designed to stop pellets and boilies. Produced in 3 different sizes suitable for different types of bait. Camouflage color.
- Étudiés pour bloquer les pellets et les bouillettes. Produits en 3 tailles différentes adaptées à différents types d'appâts. Couleur camouflage.

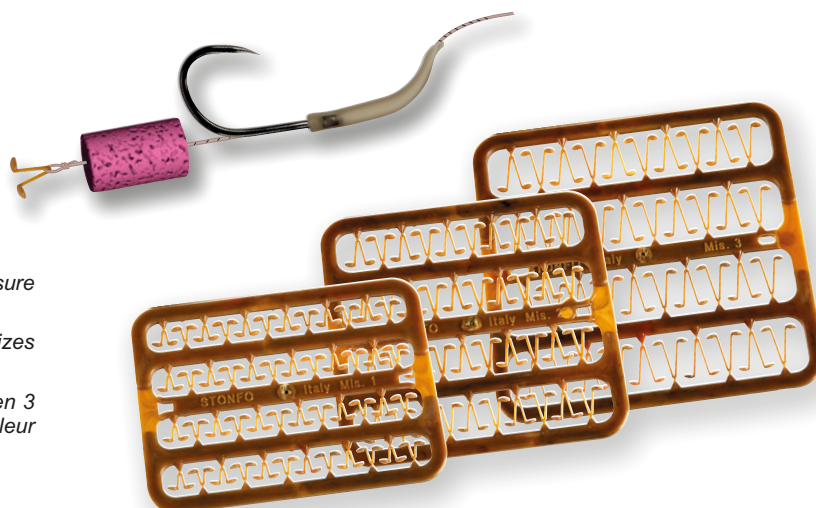

BUSTA DA 40 PEZZI - CONFEZIONE DA 10 BUSTE
40 PCS PER BAG - PACK SIZE 10 BAGS

Art.293 METAL RING

Mis sizes	dimensions ø int ø ext	
1	2,0	3,0 mm
2	2,5	3,7 mm



Mis. 1



2

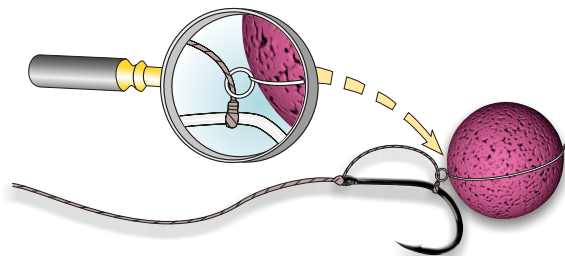

BUSTA DA 10 PEZZI - CONFEZIONE DA 10 BUSTE
10 PIECES PER BAG - PACK SIZE 10 BAGS

Art.683 HOOK STOPS



Piccole perline in gomma di forma conica studiate per realizzare terminali anti-espulsione. Si applicano facilmente in qualsiasi punto dell'amo. Colore mimetico grigio-verde.



Conical small rubber beads, designed to create anti-eject rigs. They can be applied easily onto any part of the hook. Grey-green mimetic colour.



Petites perles en caoutchouc de forme conique, étudiées pour réaliser montages anti-éjection. Elles peuvent être appliquées facilement sur n'importe quelles parties de l'hameçon. Couleur mimétique gris-vert.

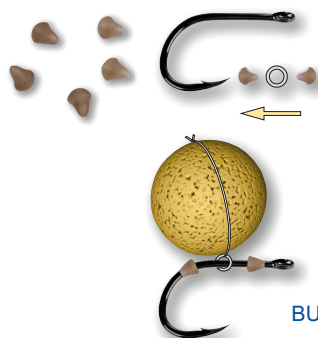

BUSTA DA 32 PEZZI - CONFEZIONE DA 10 BUSTE
32 PIECES PER BAG - PACK SIZE 10 BAGS

Art.688 LINE ALIGNER STONFO



Tubetti conici piegati in gomma, studiati per la preparazione di terminali "line aligner", garantiscono una efficace allamatura del pesce. Adatti per ami dal 6 al 2 siano essi con gambo corto o lungo. Colore mimetico grigio-verde.



Tapered bended rubber sleeves, designed to create "line aligner rigs", they improve the hooking efficiency. Suitable for both short and long shank hooks of the size from 6 to 2. Grey-green mimetic colour.



Tubes coniques coudés en caoutchouc, étudiés pour la préparation de bas des lignes "line aligner", permettent de piquer efficacement le poisson. Indiqués pour hameçons à tige courte et longue de taille de 6 à 2. Couleur mimétique gris-vert.

BUSTA DA 10 PZ. - CONF. DA 10 BU. * 10 PER BAG - PACK SIZE 10 BAGS



Art.717 SYNTHETIC CORN BUOYANT NEW 2020



Chicchi di mais artificiale di varie dimensioni, possono essere innescati da soli od in combinazione con esche naturali. La loro leggerezza può essere utilizzata per controbilanciare il peso dell'amo. Per aumentarne l'efficacia possono essere aggiunti aromi. Prodotti in tre diversi colori.



Artificial corn grains of various dimensions, they can be used alone or in combination with natural baits. Their lightness can be used to counterbalance the weight of the hook. They can be dipped in liquid flavourings to increase the attractivity. Available in 3 different colors.



Grains de maïs artificiels de différentes tailles, ils peuvent être eschés seuls ou en combinaison avec des appâts naturels. Leur légèreté peut être utilisée pour contrebalancer le poids de l'hameçon. Pour augmenter leur efficacité, peuvent être ajoutés des arômes. Disponibles en 3 couleurs différentes.

BUSTA DA 15 PZ. - CONF. DA 10 BU. * 15 PER BAG - PACK SIZE 10 BAGS

MAIS ARTIFICIALE GALLEGGIANTE
MAÏS ARTIFICIEL FLOTTANT

COLORI - COLOURS - COULEURS		
○	BIANCO - WHITE - BLANC	
●	GIALLO - YELLOW - JAUNE	
●	ROSSO - RED - ROUGE	

3 SMALL
5 MEDIUM
7 LARGE
15 PCS.TOT



Art.718 SYNTHETIC MAGGOTS BUOYANT NEW 2020



Bigattini artificiali, assortiti in varie misure, forme e colori, possono essere innescati da soli od in combinazione con esche naturali. La loro leggerezza può essere utilizzata per controbilanciare il peso dell'amo. Per aumentarne l'efficacia possono essere aggiunti aromi.



Artificial maggots, assorted in various sizes, shapes and colors, they can be used alone or in combination with natural baits. Their lightness can be used to counterbalance the weight of the hook. They can be dipped in liquid flavourings to increase the attractivity.



Asticots artificiels assortis en différentes tailles, formes et couleurs, ils peuvent être eschés seuls ou en combinaison avec des appâts naturels. Leur légèreté peut être utilisée pour contrebalancer le poids de l'hameçon. Pour augmenter leur efficacité, peuvent être ajoutés des arômes.

BUSTA DA 24 PZ. - CONF. DA 10 BU. * 24 PER BAG - PACK SIZE 10 BAGS

BIGATTINI ARTIFICIALI GALLEGGIANTI
ASTICOTS ARTIFICIELS FLOTTANT



Art.719 SYNTHETIC CASTERS BUOYANT NEW 2020



Casters artificiali, assortiti in misure e colori, possono essere innescati da soli od in combinazione con esche naturali. La loro leggerezza può essere utilizzata per controbilanciare il peso dell'amo. Per aumentarne l'efficacia possono essere aggiunti aromi.



Artificial casters, assorted in sizes and colors, they can be used alone or in combination with natural baits. Their lightness can be used to counterbalance the weight of the hook. They can be dipped in liquid flavourings to increase the attractivity.



Casters artificiels assortis en tailles et couleurs, ils peuvent être eschés seuls ou en combinaison avec des appâts naturels. Leur légèreté peut être utilisée pour contrebalancer le poids de l'hameçon. Pour augmenter leur efficacité, peuvent être ajoutés des arômes.

BUSTA DA 24 PZ. - CONF. DA 10 BU. * 24 PER BAG - PACK SIZE 10 BAGS

CASTERS ARTIFICIALI GALLEGGIANTI
CASTERS ARTIFICIELS FLOTTANT



Art.681 BUFFER BEADS

 *Perline in gomma paracolpi. Studiate per proteggere il nodo e la girella. Molto efficaci grazie alla loro forma ed al materiale particolarmente elastico. Si adattano perfettamente a girelle della misura 4. Colore mimetico grigio-verde.*

 *Buffer rubber beads. Designed to protect the knot and the swivel. Very effective thanks to their shape and ultra elastic material. Fit perfectly over swivel of the size 4. Grey-green mimetic colour.*

 *Perles en caoutchouc antichoc. Étudiées pour protéger le nœud et l'émerillon. Très efficaces grâce à leur forme et au matériau particulièrement élastique. Elles s'adaptent parfaitement aux émerillons de taille 4. Couleur mimétique gris-vert.*

BUSTA DA 15 PEZZI - CONFEZIONE DA 10 BUSTE * 15 PIECES PER BAG - PACK SIZE 10 BAGS

Art.680 RUN RIG KIT

 *Kit pronto all'uso per montaggio scorrevole. La forma dell'anello e della perlina sono studiate per avere la massima divergenza anti-groviglio. Il kit è composto da anelli, moschettoni, perline paracolpi in gomma e girelle che si adattano perfettamente alle perline. Colore mimetico grigio-verde.*

 *Ready to use kit for running rigs. The shape of the ring and the bead are designed to have the maximum anti-tangle divergence. The kit includes rings, snaps, buffer rubber beads and swivels that fit perfectly into the beads. Grey-green mimetic colour.*

 *Kit prêt à l'emploi pour le montage coulissant. La forme de l'anneau et de la perle sont étudiées pour avoir la divergence maximale anti-emmêlement. Le kit comprend anneaux, agrafes, perles en caoutchouc antichoc et émerillons qui s'adaptent parfaitement aux perles. Couleur mimétique gris-vert.*

5 KITS PER BAG
PACK SIZE 10 BAGS

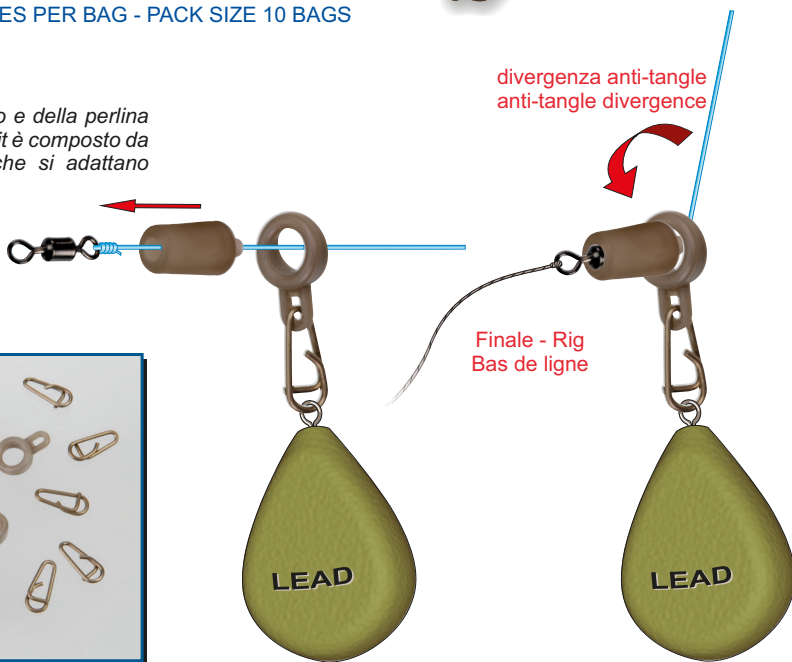
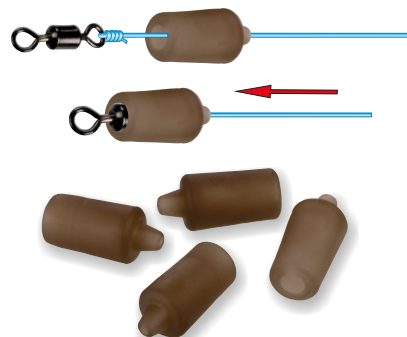

Art.710 CONNECTOR BEADS

 *Attacco per terminali integrato in una morbida perlina in gomma. Consente un cambio rapido del terminale ed al tempo stesso protegge il nodo di connessione. Disponibile in due misure. Colori mimetici.*

 *Hooklength connector integrated into a soft rubber bead. Allows a quick change of the hooklength and at the same time protect the connection knot. Available in 2 sizes. Mimetic colours.*

 *Connecteur pour bas de ligne intégré dans une perle en caoutchouc souple. Permet un changement rapide du bas de ligne et en même temps protège le nœud de connexion. Disponible en deux tailles. Couleurs mimétiques.*

BUSTA DA 8 PEZZI - CONFEZIONE DA 10 BUSTE
8 PER BAG - PACK SIZE 10 BAGS

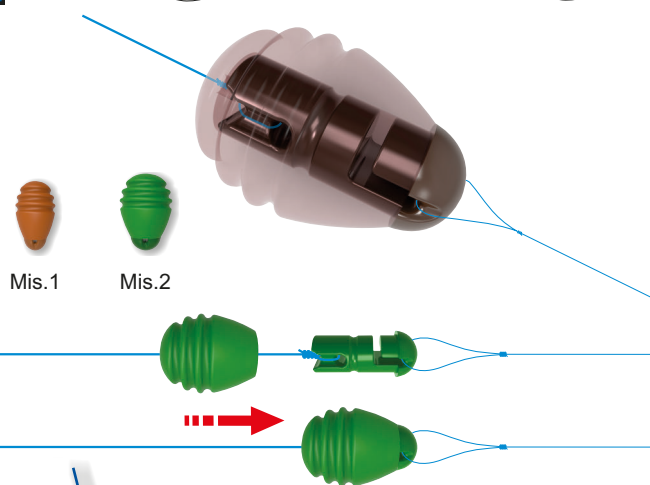

Art.151 HELICOPTER

 *Componenti per Helicopter completi di girella.*

 *Helicopter rig beads with swivels.*

 *Perles Hélicoptère avec émerillons.*

BUSTA DA 5 PEZZI - CONFEZIONE DA 10 BUSTE
5 PIECES PER BAG - PACK SIZE 10 BAGS

Art.152 HELICOPTER KIT

 *Kit completo per 5 Helicopters con perline, girelle, manicotti in gomma e tubetto anti-tangle morbido (2 mt). Diventa autoferrante mettendo il gommino sulla girella del piombo.*

 *Helicopter Kit for 5 rigs including beads, swivels, rubber sleeves and 2 mt anti-tangle tubing. Use the connecting rubber tubing to fix the lead aiding hooking chances.*

 *Kit pour 5 Hélicoptères avec perles, émerillons, gaine en caoutchouc et 2 mt gaine anti-emmêlage. Auto-ferrage avec la gaine sur l'émerillon du plomb.*

BUSTA DA 5 PEZZI - CONFEZIONE DA 10 BUSTE
5 PIECES PER BAG - PACK SIZE 10 BAGS



Art.156 LEAD CLIPS

 Clips di attacco per piombo (5 pz.) completi di tubetto anti-tangle morbido (2 mt), manicotti in gomma, girelle e perline salvanodo

 Lead Clips (5 pcs.) including 2 mt anti-tangle tubing, rubber sleeves, swivels and shock absorbing rubber beads.

 Clips pour plomb (5 pcs.) avec tube souple anti-emmêlage (2 mt), gaine en caoutchouc, émerillons et perles protégées nœuds en caoutchouc.



Autoferrante con piombo fisso
Fixed-Lead
Auto-ferrage avec le plomb fixe

Gommino blocca girella
Connecting rubber tubing
Gaine bloque émerillon

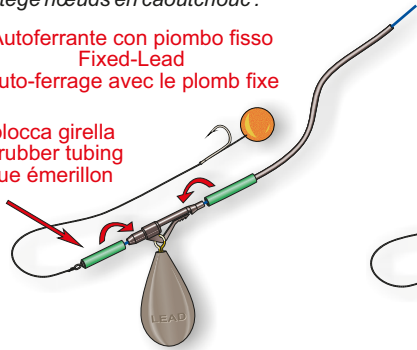

Piombo Scorrevole
Running Lead
Plomb Coulissant

Perlina Salvanodo
Shock Absorber
Perle caoutchouc

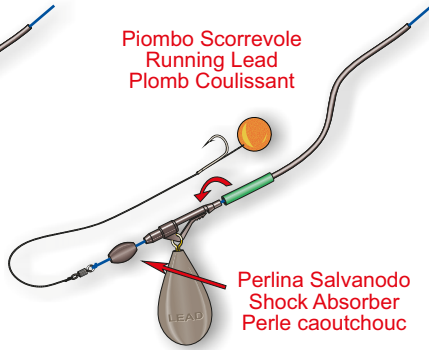

BUSTA DA 5 PEZZI - CONF. DA 10 BUSTE
5 PIECES PER BAG - PACK SIZE 10 BAGS

Art.437 LEAD CLIP MAXI

 Clips di attacco per piombo complete di conetti in gomma e girelle.

 Lead Clips including coniform rubber tails and swivels.

 Clips pour plomb munies de caoutchouc conique et d'émerillons.



BUSTA DA 10 PEZZI - CONFEZIONE DA 10 BUSTE * 10 PIECES PER BAG - PACK SIZE 10 BAGS

Art.239 CONETTI IN GOMMA CONIFORM RUBBER TAILS

 Conetti in gomma coprinodo. Ottimi per il surf-casting ed il carp fishing riducono il rischio di aggrovigliamenti ed evitano l'aggancio di alghe sul nodo. Prodotti in tre diverse misure.

 Coniform rubber tails. Suitable for surf-casting and carp fishing to avoid tangles. Available in three different sizes.

 Caoutchouc conique anti-emmêleur excellent pour le surf-casting et le carp-fishing. Trois tailles.

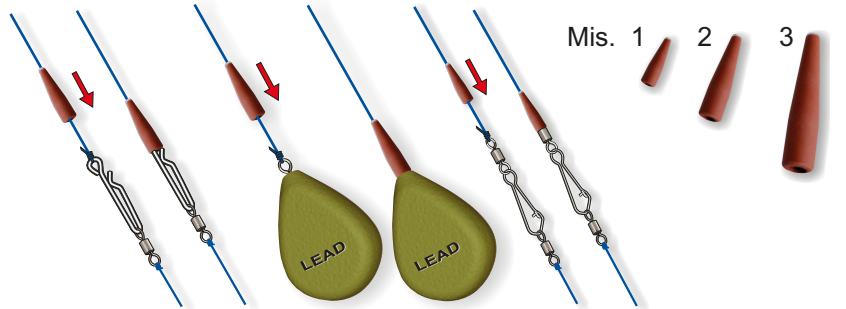

BUSTA DA 10 PEZZI - CONFEZIONE DA 10 BUSTE
10 PIECES PER BAG - PACK SIZE 10 BAGS

Art.662 CONI ANTI TANGLE ANTI TANGLE SLEEVES - MANCHONS ANTI-EMMÊLEURS

 Coni in gomma morbida anti groviglio. Si inseriscono agevolmente su girelle della misura da 8 a 5 proteggendone il nodo. Mantengono inoltre il terminale ben disteso e lontano dal piombo durante il lancio evitando fastidiosi grovigli. Disponibili in due diverse lunghezze. Colore mimetico grigio-verde.

 Soft rubber anti tangle cones. Fit easily over swivel of the size from 8 to 5, protecting the knot. They lay out the rig, pushing it away from the lead when casting in order to avoid tangles. Available in two different lengths. Grey-green mimetic colour

 Cônes anti-emmêlement en caoutchouc. Faciles à insérer sur émerillons de taille de 8 à 5 pour protéger le nœud. Ils gardent le bas de ligne droit et loin du plomb pendant le lancer en évitant les emmêlements. Disponibles en deux différentes longueurs. Couleur mimétique gris-vert.

BUSTA DA 12 PEZZI - CONFEZIONE DA 10 BUSTE
12 PIECES PER BAG - PACK SIZE 10 BAGS

Art.669 KIT LINE CONNECTOR

 Il kit comprende coni in gomma morbida anti groviglio e moschettoni inox rapidi ellittici. Il cono in gomma mantiene il terminale ben disteso eliminando fastidiosi grovigli, mentre il moschettonone permette un cambio rapido dello stesso. Disponibile in due misure con coni di diversa lunghezza. Colore mimetico grigio-verde.

 The kit includes anti tangle sleeves and elliptical inox quick snaps. The soft rubber cone lay out the rig in order to avoid tangles while the snap allows to quickly change it. Available in two sizes with cones of different length. Grey-green mimetic colour.

 Le kit comprend manchons anti-emmêleurs et agrafes en acier inox rapides elliptiques. Le cône en caoutchouc souple garde le bas de ligne droit en évitant les emmêlements alors que l'agrafe permet de le changer rapidement. Disponible en deux tailles avec cônes de longueur différente. Couleur mimétique gris-vert.

BUSTA DA 6 PEZZI - CONFEZIONE DA 10 BUSTE
6 PIECES PER BAG - PACK SIZE 10 BAGS

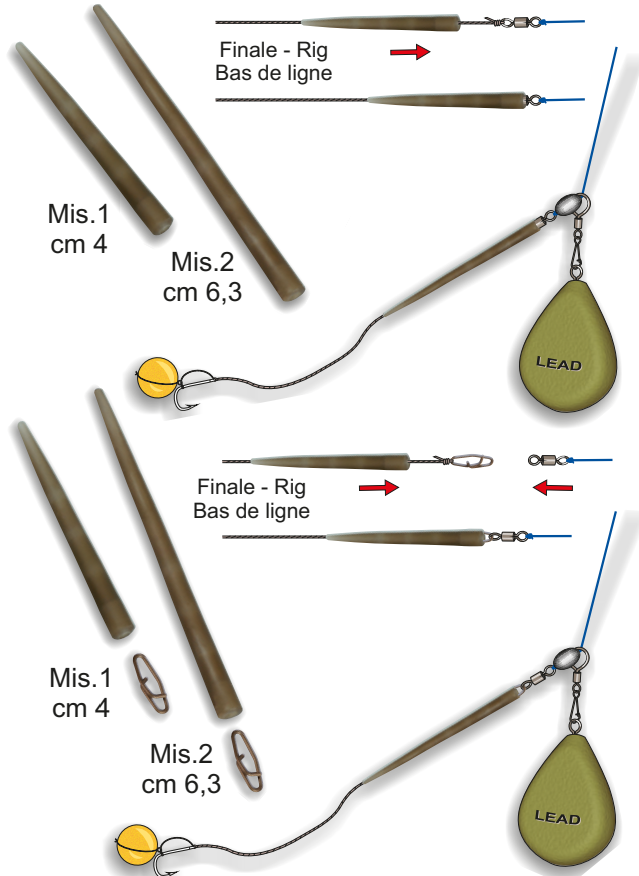

Art.458 BACK LEAD CLIP

 Gancetti per piombo tendifilo. Prodotti in materiale molto resistente consentono la massima scorrevolezza sul filo. Forniti completi di tubetti in silicone trasparente per una rapida intercambiabilità del piombo.

 Back lead clips made of strong and self lubricating material. Supplied with clear silicon tubes that permit a quick change of the lead.

 Agrafes en matériau autolubrifiant pour plomb tendeur de ligne. Livrées avec gaine en silicone transparent pour permettre un rapide remplacement du plomb.

BU. DA 6 PZ. - CONF. DA 10 BUSTE * 6 PCS PER BAG - PACK SIZE 10 BAGS



Art.379 FILO PVA IDROSOLUBILE PVA STRING - FIL EN PVA

 Filo in PVA idrosolubile, disponibile in due misure, si dissolve rapidamente al contatto con l'acqua. Fornito in una pratica bobina chiusa da 50 metri che lo protegge dall'umidità.

 PVA string available in two different sizes for any type of bait. Strong. Cold water melting. Supplied in a special spool, to protect it from water and dirt. 50 metres spool.

 Fil en PVA soluble dans l'eau. Disponible en deux tailles en bobine de 50 mètres. La spéciale bobine est pratique à l'usage et protège le fil de l'eau et des saletés.

BOBINA DA 50 METRI - CONF. DA 10 BOBINE
50 METRES PER SPOOL - PACK SIZE 10 SPOOLS





Mis. 1 Ø Piccolo-Small
Mis. 2 Ø Grande-Big

SACCHETTI PVA IDROSOLUBILI PVA BAIT BAGS

Art. 222	Dim. LxH	70 x 110 mm
Art. 225	Dim. LxH	70 x 200 mm
Art. 226	Dim. LxH	80 x 130 mm
Art. 227	Dim. LxH	100 x 150 mm
Art. 228	Dim. LxH	140 x 200 mm

 Sacchetti in PVA idrosolubili, si dissolvono rapidamente a contatto con l'acqua. Ottimi per una precisa pasturazione sul luogo di pesca. Disponibili in varie grandezze per molteplici tipi di esche.

 PVA bait bags available in different sizes for any type of bait. Strong. Cold water melting. Ideal for accurate baiting.

 Sacs en PVA solubles dans l'eau. Disponibles en plusieurs tailles pour pellets, maïs, bouillettes, asticots, amorces etc.etc.

BU. DA 10 PZ.-CONF. DA 10 BUSTE * 10 PCS PER BAG-PACK SIZE 10 BAGS



Anche in acqua fredda
Aussi in eau froide
cold water melting

Art.245-3 FILO ELASTICO PER BOILIES BOILIES ELASTIC

 Elastico sottilissimo è ottimo per legare le boilies sul metal ring. La speciale bobina protegge l'elastico dalla luce e dallo sporco e ne facilita l'utilizzo. Bobina da 12 metri.

 Very thin Boilie elastic, excellent to tie the boilie on the hook. Supplied in a special spool to protect it from light and dirt and make its use easier. 12 meters per spool.

 Élastique pour bouillettes, il est idéal pour fixer les bouillettes à l'hameçon. Fourni en bobine, il est pratique à l'usage et est protégé de la lumière et des saletés. Bobine de 12 mètres.

BUSTA DA 1 BOBINA - CONF. DA 10 BUSTE
1 SPOOL PER BAG - PACK SIZE 10 BAGS

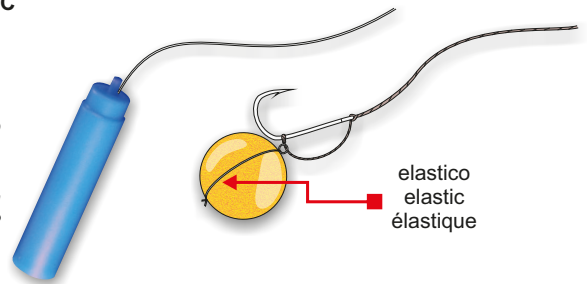

elastico
elastic
élastique

Art.135 ANELLI ELASTICI PER ESCHE BAIT ELASTIC BANDS - BAGUES ÉLASTIQUES POUR ESCHEs

BAIT ELASTIC BANDS - BAGUES ÉLASTIQUES POUR ESCHEs

Mis. 0	1	2	2,5	3
Ømm 1,5	2,5	3,5	4,0	6,0

insertore
introducteur
inserter

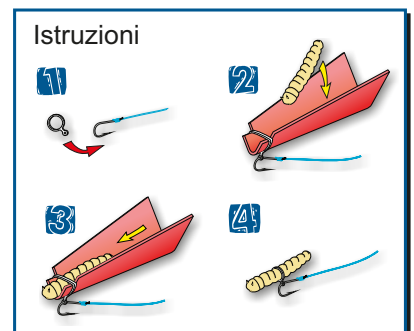
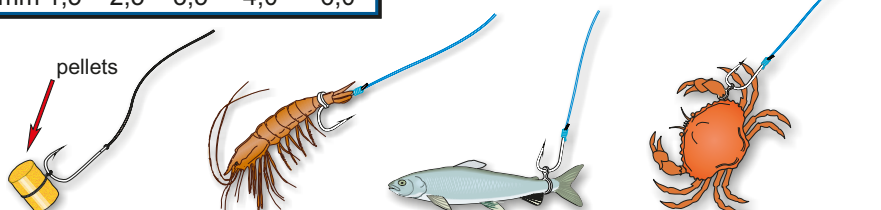

BUSTA DA 24 PZ. CON INSERITORE - CONF. DA 10 BUSTE
24 PCS PER BAG WITH INSERTER - PACK SIZE 10 BAGS

Art.137

ANELLI ELASTICI PER ESCHE GRANDI

BIG MODEL BAIT ELASTIC BANDS - BAGUES ÉLASTIQUES POUR ESCHEs GRANDES

Mis sizes	Ø mm	esca-pellet Ø min Ø max	
0	4,0	6	10 mm
1	6,0	10	18 mm
2	8,5	16	25 mm

Mis. 0 1 2

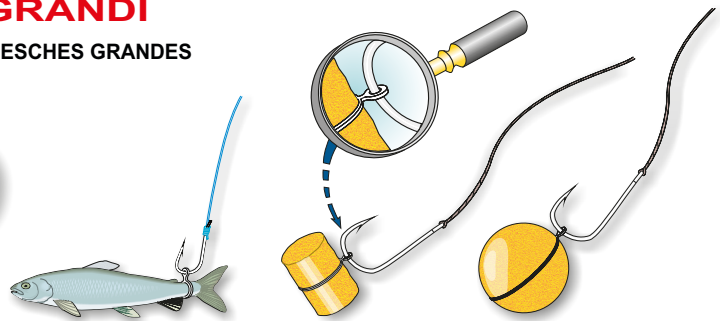

BUSTA DA 18 PEZZI - CONFEZIONE DA 10 BUSTE
18 PIECES PER BAG - PACK SIZE 10 BAGS

Art.596

ANELLI ELASTICI PER ESCHE MAGNUM

MAGNUM BAIT ELASTIC BANDS
BAGUES ÉLASTIQUES POUR ESCHEs MAGNUM

Mis sizes	Ø mm	esca-bait Ø min Ø max	
1	12	18	50 mm
2	16	25	70 mm

Mis. 1 2

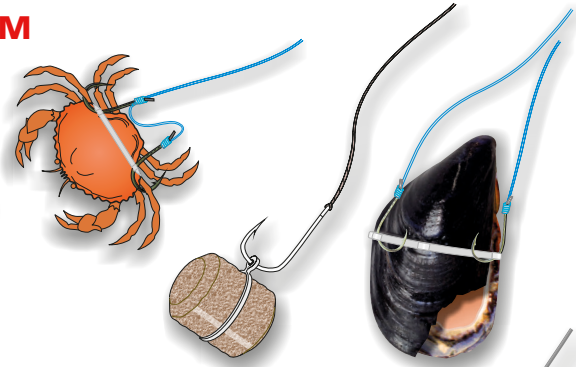

BUSTA DA 12 PEZZI - CONFEZIONE DA 10 BUSTE
12 PIECES PER BAG - PACK SIZE 10 BAGS

Art.722

BAIT BANDS TRIS

Anelli elastici per innesco triplo o doppio di pellets e boilies. Per l'innesco doppio tagliare il terzo anello.

Bait bands for triple or double hook baiting of pellets and boilies. For double hook baiting cut the third ring.

Anneaux élastiques pour l'eschage triple ou double des pellets et boilies. Pour l'eschage double couper le troisième anneau.

BUSTA DA 12 PEZZI - CONFEZIONE DA 10 BUSTE
12 PIECES PER BAG - PACK SIZE 10 BAGS

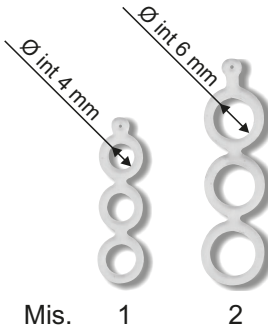

Mis. 1 2



Art.697

BAIT BANDER TOOL



Strumento per allargare l'elastico permettendo un facile inserimento di pellets o di altre esche. Grande apertura. Confezione completa di 24 elastici nelle mis. 2-2,5-3 adatti per esche da 3 a 18 mm.



Tool to open the elastic band allowing an easy insertion of pellets and other baits. Wide opening. Supplied with 24 bait elastic rings size 2-2,5-3 suitable for baits from 3 to 18 mm.



Outil pour élargir l'élastique en permettant une insertion facile des pellets ou des autres appâts. Large ouverture. Livré avec 24 bagues élastiques pour esches taille 2 - 2,5 - 3 aptes pour pellets de 3 à 18 mm.

BLISTER DA 1 PEZZO - CONFEZIONE DA 10 BUSTE
1 PIECE PER BLISTER - PACK SIZE 10 PIECES



Art.139

BLOCCA ESCA BAIT HOLDER - BLOQUE ESCHE

Mis. 1
mm 18

Mis. 2
mm 30

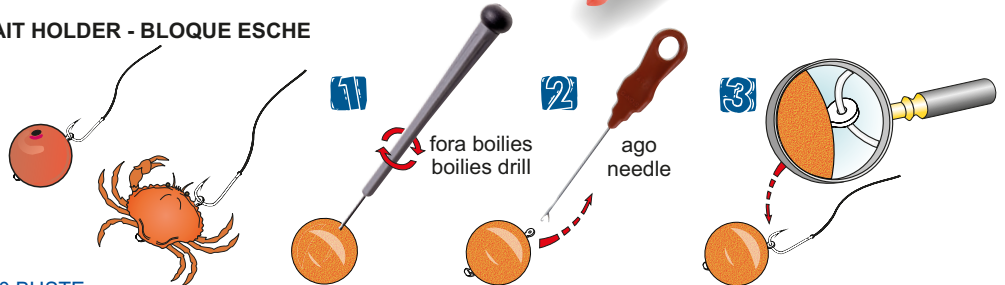

BUSTA DA 24 PEZZI - CONFEZIONE DA 10 BUSTE
24 PCS PER BAG - PACK SIZE 10 BAGS

Art.140

KIT BLOCCA ESCA BAIT HOLDER KIT - KIT BLOQUE ESCHE

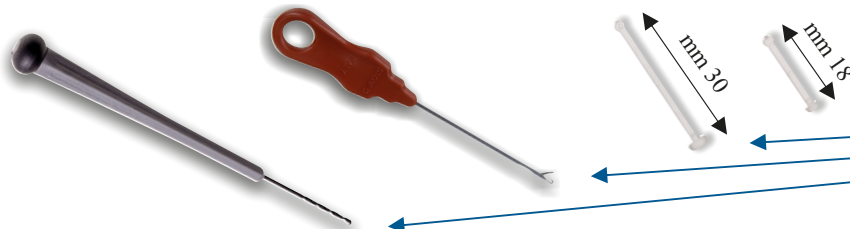

BUSTA DA 1 KIT - CONF. DA 10 BUSTE
1 KIT PER BAG - PACK SIZE 10 BAGS

STONFO

High quality fishing tackle manufacturer

Art.140
KIT BLOCCA ESCA

Contiene: Contents:

- Pz.36 blocca esca mis.1
- Pz.36 blocca esca mis.2
- Ago per boilies
- Fora boilies

Pcs.36 bait holder size 1
Pcs.36 bait holder size 2
Boilies needle
Boilies drill

made in Italy

SERBIDORA STONFO BAIT TRAY STONFO



Serbidora ripiegabile e leggera progettata per venire incontro alle molteplici esigenze del pescatore. La sua struttura in materiale plastico resistentissimo è perfettamente smussata e priva di angoli taglienti. Le nicchie di cui è munita possono contenere varie vaschette porta-esche in posizione perfettamente stabile. Altre caratteristiche importanti fanno di questa serbidora un vero e proprio completo banco di lavoro. Attacco a vite metallica universale per paletto posto centralmente. Massima leggerezza gr 700. Dimensioni cm 45x36. Minimo ingombro da chiusa cm 36x26



Folding, light weight bait tray designed to meet the many needs of fisherman. Its structure, in durable plastic, is perfectly rounded and has no sharp edges. The compartments can hold various bait boxes in stable position. Other important features make this bait tray a well equipped working station. A universal metal screw connection is placed in the center. Lightweight 700 gr. Dimension 45x36 cm. Minimal space when closed 36x26 cm



Plateau porte appâts léger et repliable étudié pour les pêcheurs plus exigeants. Sa structure en plastique très solide est parfaitement arrondie. Il est muni de plusieurs logements pour boîtes à éches. Autres considérables caractéristiques font de ce plateau un complet banc de travail. Fixation à vis métal central. Très léger 700 gr. Dimensions 45x36 cm. Encombrement après fermé 36x26 cm.

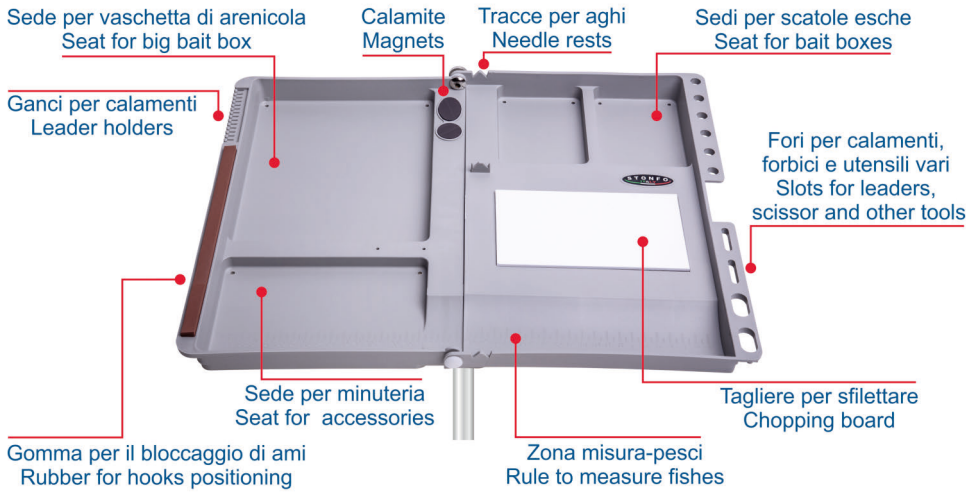

CONFEZIONE DA 1 PEZZO
PACK SIZE 1 PIECE

SERBIDORA JOLLY BAIT TRAY JOLLY



Serbidora in materiale plastico resistentissimo perfettamente smussato e privo di angoli taglienti. Munita di nicchia per contenere vaschette porta-esche e minuteria varia in modo stabile e sicuro. Molte altre caratteristiche importanti fanno di questa serbidora un vero e proprio completo banco di lavoro sia per la pesca da riva che dalla barca. Dimensioni cm 39x28. Fornita completa di morsetto e giunto regolabile per il fissaggio su tripode.



Bait station designed to meet the many needs of fisherman. Its structure in durable plastic is perfectly rounded and has no sharp edges. The compartment can hold various bait boxes or tools in a stable position. Other important features make this bait tray a well equipped working station for every kind of fishing. Dimension 39x28 cm. Supplied with clamp and angle lock connector for fixing on the tripod.



Plateau porte appâts étudié pour les pêcheurs plus exigeants. Sa structure en plastique est très solide et parfaitement arrondie. Il est muni de logement pour boîtes à éches et accessoires. Autres considérables caractéristiques font de ce plateau un complet banc de travail pour tous les types de pêche. Fourni avec dispositif de serrage et tête orientable de fixation pour trépied.

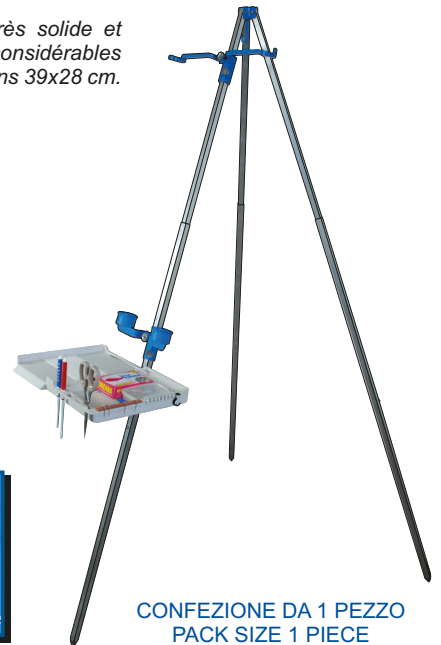
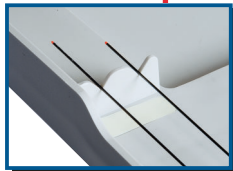
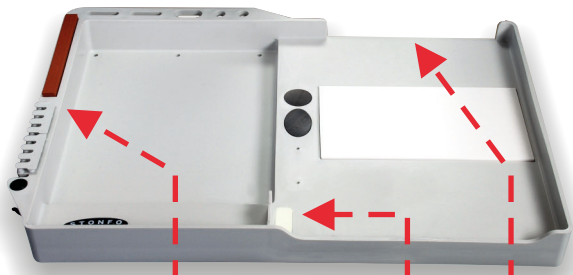

GOMMA GALLEGGIANTE

BUOYANT RIG FOAM 80X60X8



Gomma galleggiante ultraleggera ideale per zatterini e per alleggerire o sollevare dal fondo ogni tipo di esca e renderla così più catturante. Tavoletta di mm 80x60x8.



Buoyant ultralight foam mm 80x60x8 available in white, red and yellow colour. Ideal for popping up various types of bait, improving their visibility.



Mousse flottante ultralégère mm 80x60x8 disponible dans les couleurs blanc, rouge et jaune. Idéal pour créer des bas de ligne ou des esches flottantes.



Colori - Colours:
Bianco - White
Rosso - Red
Giallo - Yellow

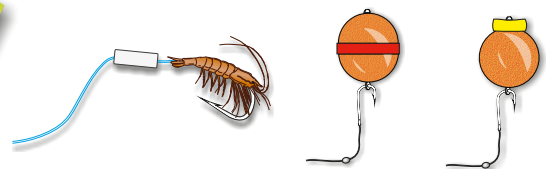

BUSTA DA 1 PEZZO - CONFEZIONE DA 10 BUSTE
1 PIECE PER BAG - PACK SIZE 10 BAGS

GOMMA GALLEGGIANTE BARRETTE

BUOYANT RIG FOAM



Gomma galleggiante ultraleggera ideale per zatterini e per alleggerire o sollevare dal fondo ogni tipo di esca (boilies, pesce morto etc.) e renderla così più catturante.



Buoyant ultralight foam available in three different sizes in white, red and yellow colours. Ideal for popping up various types of bait (boilies, deadbait, etc.), improving their visibility.



Mousse flottante ultralégère disponible en trois tailles dans les couleurs blanc, rouge et jaune. Idéal pour créer des bas de ligne ou des esches flottantes (boilies, poissons mort etc.).



Colori - Colours:
Bianco - White
Rosso - Red
Giallo - Yellow

Art. 205	Dim. mm 6x 6x 100
Art. 206	Dim. mm 8x 8x 100
Art. 207	Dim. mm 10x10x100

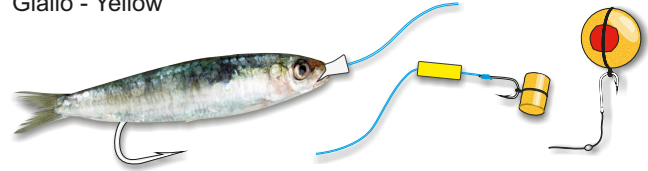

BUSTA DA 6 PEZZI - CONFEZIONE DA 10 BUSTE
6 PIECES PER BAG - PACK SIZE 10 BAGS

FILO ELASTICO PER ESCHE

BAITS ELASTIC LINE



Filo elastico trasparente sottilissimo, praticamente invisibile, ottimo per legare sull'amo le esche più fragili. La speciale bobina protegge l'elastico dalla luce e dallo sporco e ne rende più agevole l'impiego. Disponibile in 3 misure.



Baits elastic line, transparent and very thin, it is excellent to tie the most delicate baits on the hook. Supplied in a special bobbin to protect it from light and dirt and make its use easier. Available in 3 sizes.



Fil élastique transparent très fin pour fixer les appâts fragiles sur l'hameçon. La spéciale bobine est pratique à l'usage et protège le fil de la lumière et des saletés. Disponible en 3 mesures.

Art.245



Piccolo mt 50
small size - très fin

Art.245-2



Medio mt 25
medium size - moyen

Art.245-1



Grande mt 12
big size - grand

BUSTA DA 1 BOBINA - CONF. DA 10 BUSTE
1 SPOOL PER BAG - PACK SIZE 10 BAGS

FILO ELASTICO PER ESCHE MAGNUM

MAGNUM BAITS ELASTIC LINE



Filo elastico trasparente sottilissimo ottimo per legare sull'amo le esche più fragili. La speciale bobina più capiente protegge l'elastico dalla luce e dallo sporco. Disponibile in 3 misure.



Baits elastic line, transparent and very thin, it is excellent to tie the most delicate baits on the hook. Supplied in a special bigger bobbin to protect it from light and dirt and make its use easier. Available in 3 sizes.



Fil élastique transparent très fin pour fixer les appâts fragiles sur l'hameçon. La spéciale bobine avec une grande capacité est pratique à l'usage et protège le fil de la lumière et des saletés. Disponible en 3 mesures.



Art.370

Piccolo mt 120
small size - très fin



Art.371

Medio mt 60
medium size - moyen



Art.372

Grande mt 30
big size - grand

BUSTA DA 1 BOBINA - CONF. DA 10 BUSTE
1 SPOOL PER BAG - PACK SIZE 10 BAGS

PORTASTARLIGHT

STARLIGHT HOLDER

Art.256

Misure piccole - Small sizes



Mis. 1A 1B 2 3

Art.256-1

Misure grandi-Big sizes

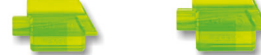

Mis. 4 5



Portastarlight per fissare lo starlight alla vetta in maniera rapida e sicura. Prodotti con materiale di colore verde-fluorescente che amplifica la luce dello starlight. Si blocca in modo rapido e sicuro inserendo la vetta nel Portastarlight e facendo scorrere la guida fino a serrarlo.



Starlight holder with special "lock and slide" fit. Assembly: insert the tip into Starlight-holder and push the slide in order to lock it on the tip.



Portestarligh, permet de bloquer rapidement le starlight sur le scion.

MIS.	ø vetta - tip da mm	a mm	starlight ø mm
1A	1,2	2,5	3
1B	1,2	2,5	4,5
2	2,5	3,7	3-4,5
3	3,7	5,2	4,5-6
4	5,2	6,6	4,5-6
5	6,6	8,0	4,5-6

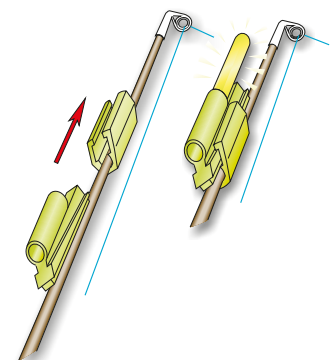

BUSTA DA 1 PZ - CONF. DA 10 BUSTE
1 PIECE PER BAG - PACK SIZE 10 BAGS

Art.62

SEGNALATORE W1

BITE INDICATOR W1



Segnalatore d'abboccata di peso leggero adatto per il surfcasting ed il carp fishing. Munito di pinzetta con regolazione della tensione per lo sgancio del filo e alloggiamento per starlight di mm 3 e 4,5.



Bite indicator lightweight for surfcasting and carp fishing. Equipped with line release clip with tension adjustment. Starlight mm 3 and 4,5 slot.



Avertisseurs de touche de poids léger pour surfcasting et carp fishing. Munis d'accroche-ligne réglable et emplacement pour starlight de 3 et 4,5 mm.

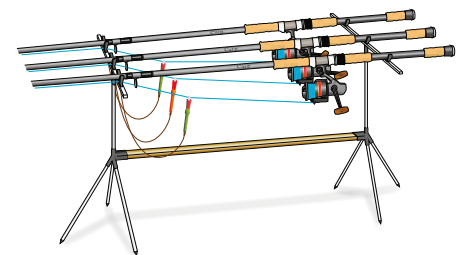



BUSTA DA 1 PEZZO - CONF. DA 5 BUSTE
1 PIECE PER BAG - PACK SIZE 5 BAGS

Art.63 **SEGNALATORE W3**

BITE INDICATOR W3

 Segnalatore d'abboccata con pesi intercambiabili, adatto per il surfcasting ed il carp fishing. Munito di pinzetta con regolazione della tensione per lo sgancio del filo e alloggiamento per starlight di mm 3 e 4,5. Fornito completo di pesi di gr 1-10-30.

 Bite indicator with interchangeable weights for surfcasting and carp fishing. Equipped with line release clip with tension adjustment. Starlight mm 3 and 4,5 slot. Weights supplied: 1 gr -10 gr -30 gr.

 Avertisseur de touche avec poids additionnels pour surfcasting et carp fishing. Muni d' accroche-ligne réglable et emplacement pour starlight de 3 et 4,5 mm. Livré avec poids de 1 gr -10 gr -30 gr.

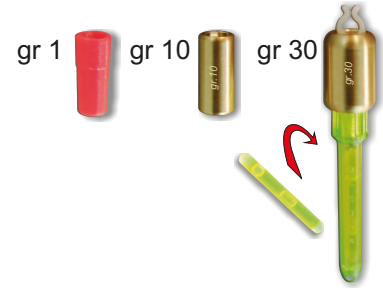
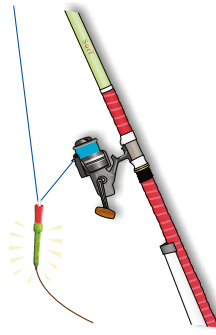

BUSTA DA 1 PEZZO - CONF. DA 5 BUSTE
1 PIECE PER BAG - PACK SIZE 5 BAGS

Art.87 **AGO LONG SIZE 2** LONG SIZE NEEDLE 2 - AIGUILLE LONGUE AVEC CROQUET 2

 Ago lungo in acciaio inox realizzato con macchinari di alta precisione. Stelo sottilissimo Ø 0,8 mm. Gancino piccolissimo.

 Long size stainless steel needle manufactured with high precision machines. Very thin stem Ø 0,8 mm. Very small hook.

 Aiguille longue en acier inox produite par machines de haute précision. Tige très fin Ø 0,8 mm. Crochet très petit.

Mis. 1 CM 10
Mis. 2 CM 14

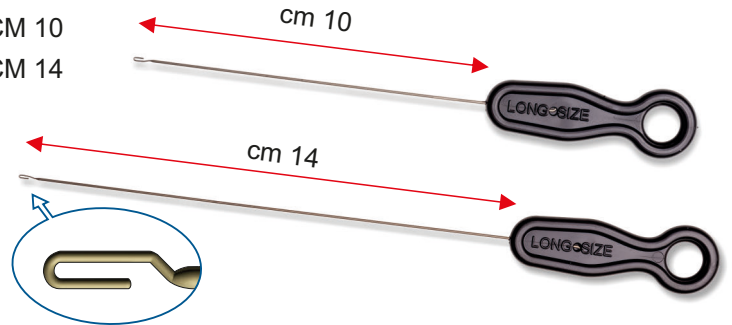

BUSTA DA 1 PEZZO - CONFEZIONE DA 10 BUSTE
1 PIECE PER BAG - PACK SIZE 10 BAGS

AGHI PER INNESCHI BAITING NEEDLE - AIGUILLE À VIF

Art.354-1	Ø 2,0	Lunghezza-Length	230 mm
Art.354-2	Ø 2,5	Lunghezza-Length	230 mm
Art.355-1	Ø 2,0	Lunghezza-Length	300 mm
Art.355-2	Ø 2,5	Lunghezza-Length	300 mm

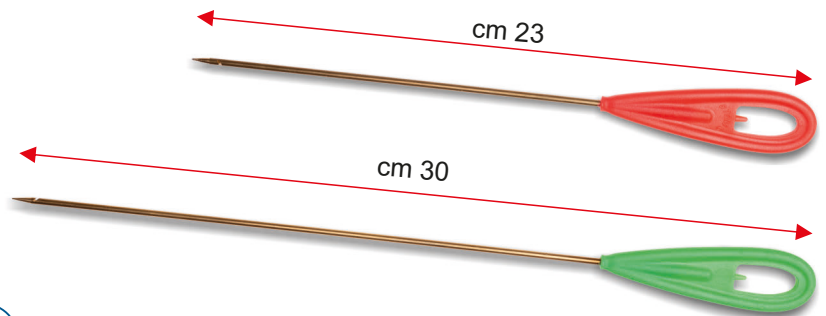

BUSTA DA 1 PEZZO - CONFEZIONE DA 10 BUSTE
1 PIECE PER BAG - PACK SIZE 10 BAGS

Art.712 **BAITING TWIN NEEDLE**

 Ago doppio inox, ottimo per facilitare l'innesco sull'amo di sardine, cozze, gamberi, canolicchi etc. La distanza tra gli aghi può essere variata da 5 a 15 mm permettendo così con un solo attrezzo di realizzare micro inneschi oppure bocconi più voluminosi.

 Stainless steel twin needle, perfect for baiting on the hook of sardines, mussels, prawns, razor clams, etc. The distance between the needles can be adjusted from 5 to 15 mm allowing the use of baits of various sizes.

 Aiguille double, parfait pour escher facilement sur l'hameçon sardines, moules, crevettes, couteaux, etc. La distance entre les aiguilles peut être variée de 5 à 15 mm en permettant l'utilisation d'esches de différentes tailles.

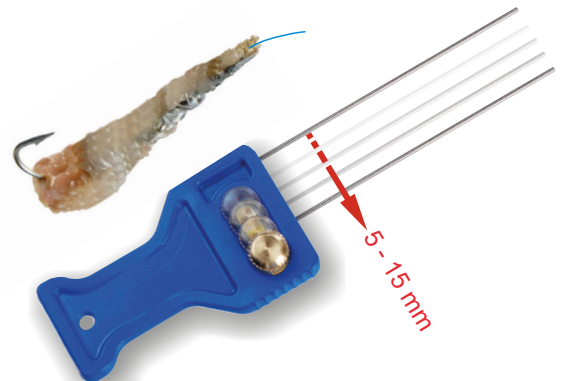

BUSTA DA 1 PEZZO - CONF. DA 10 BUSTE * 1 PER BAG - PACK SIZE 10 BAGS

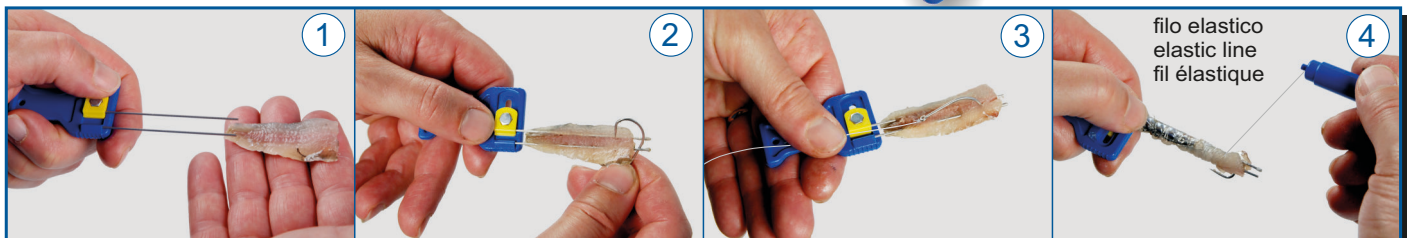

AGHI PASSAFILO LINE THREADING NEEDLES - AIGUILLES PASSE-FIL

Art.223/15	Ø 0,6	Lunghezza-Length 150 mm
Art.223/25	Ø 0,6	Lunghezza-Length 250 mm
Art.223-1/20	Ø 1,0	Lunghezza-Length 200 mm
Art.223-1/34	Ø 1,0	Lunghezza-Length 340 mm

acciaio inox
stainless steel
acier inox

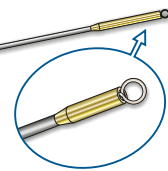

BUSTA DA 2 PEZZI - CONFEZIONE DA 10 BUSTE
2 PIECES PER BAG - PACK SIZE 10 BAGS

AGHI PER ESCHE BAIT NEEDLES - AIGUILLES À VERS

Art.223-2/12	Ø 0,6	Lunghezza-Length 120 mm
Art.223-2/20	Ø 0,6	Lunghezza-Length 200 mm
Art.223-3/12	Ø 1,0	Lunghezza-Length 120 mm
Art.223-3/20	Ø 1,0	Lunghezza-Length 200 mm

acciaio inox
stainless steel
acier inox

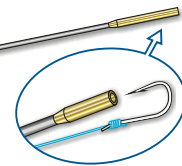



BUSTA DA 2 PEZZI - CONFEZIONE DA 10 BUSTE
2 PIECES PER BAG - PACK SIZE 10 BAGS

AGHI TUBOLARI SENZA PUNTA TUBULAR NEEDLES WITHOUT TIP - AIGUILLE INOX SANS POINTE

Art.424	Ø 1,0	Lunghezza-Length 150 mm
	Ø 1,0	Lunghezza-Length 200 mm
Art.428	Ø 1,0	Lunghezza-Length 300 mm

 Aghi infilavermi tubolari in acciaio inox senza punta. Permettono di scegliere da che parte innescare il verme, se dalla testa o dalla coda.

 Stainless steel tube needle without point for threading worms. Allows to choose if thread the worm on the head side or on the other side.

 Aiguille à vers en tube d'acier inox sans pointe. Permet de choisir si enfiler le ver par la tête ou de l'autre côté.

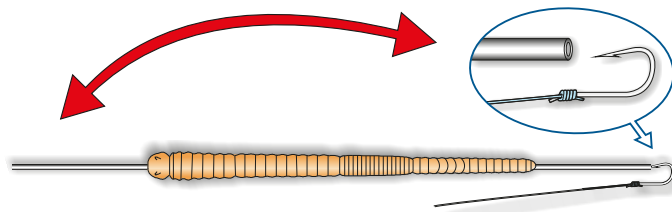

BUSTA DA 5 PZ. - CONF. DA 10 BUSTE
5 PIECES PER BAG - PACK SIZE 10 BAGS

Art.550 AGHI Ø 0,8 TESTA BIANCA WHITE POINT NEEDLES Ø 0,8

 Aghi tubolari sottilissimi in acciaio inox con punta in materiale plastico super scorrevole. Il colore visibilissimo della punta e la sua forma ogivale servono a prevenire deviazioni indesiderate della traiettoria di innesco. Ideali per arenicola.

 Very thin diameter stainless steel lugworm needle. The highly visible colour of the plastic point and its ogival shape allow an easy threading of the worm without any deviation.

 Aiguille de petit diamètre en acier inox avec pointe en plastique autolubrifiante. La couleur très visible de la pointe et sa forme ogivale permettent un eschage rapide sans déviations. Idéale pour arénicole.

Art.550	Ø 0,8	Lunghezza-Length 200 mm
	Ø 0,8	Lunghezza-Length 300 mm

BUSTA DA 5 PZ. - CONF. DA 10 BUSTE
5 PIECES PER BAG - PACK SIZE 10 BAGS

AGHI TESTA ROSSA

RED POINT NEEDLES

Art.454	Ø 1,0	Lunghezza-Length 150 mm
	Ø 1,0	Lunghezza-Length 200 mm
Art.455	Ø 1,0	Lunghezza-Length 300 mm

 Aghi infilavermi tubolari in acciaio inox con punta in materiale plastico super scorrevole. Il colore fluorescente visibilissimo della punta e la sua forma ogivale servono a prevenire deviazioni indesiderate della traiettoria di innesco.

 Stainless steel worm needle. The highly visible fluorescent colour of the plastic point and its ogival shape allow an easy threading of the worm without any deviation.

 Aiguille à vers en acier inox avec pointe en plastique autolubrifiante. La couleur fluorescente très visible de la pointe et sa forme ogivale permettent un eschage rapide sans déviations.

BUSTA DA 5 PZ. - CONF. DA 10 BUSTE
5 PIECES PER BAG - PACK SIZE 10 BAGS

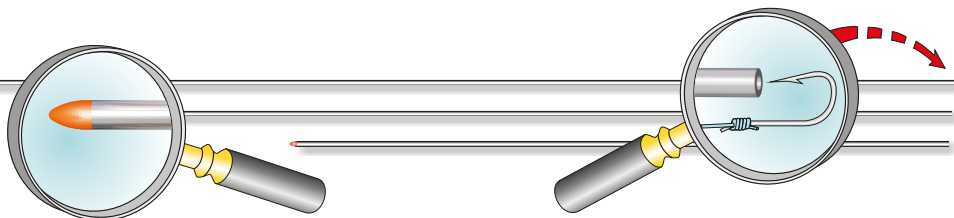

AGHI TESTA ROSSA ARENICOLA LUGWORM NEEDLES

Art.460 Ø 1,0 Lunghezza-Length 400 mm



Aghi tubolari per arenicola in acciaio inox con punta in materiale plastico super scorrevole. Il colore visibilissimo della punta e la sua forma ogivale servono a prevenire deviazioni indesiderate della traiettoria di innesco.



Stainless steel lugworm needle. The highly visible colour of the plastic point and its ogival shape allow to thread easily the worm without any deviation.



Aiguille à arénicole en acier inox avec pointe en plastique autolubrifiante. La couleur très visible de la pointe et sa forme ogivale permettent un eschage rapide sans déviations.

BUSTA DA 5 PZ. - CONF. DA 10 BUSTE
5 PIECES PER BAG - PACK SIZE 10 BAGS

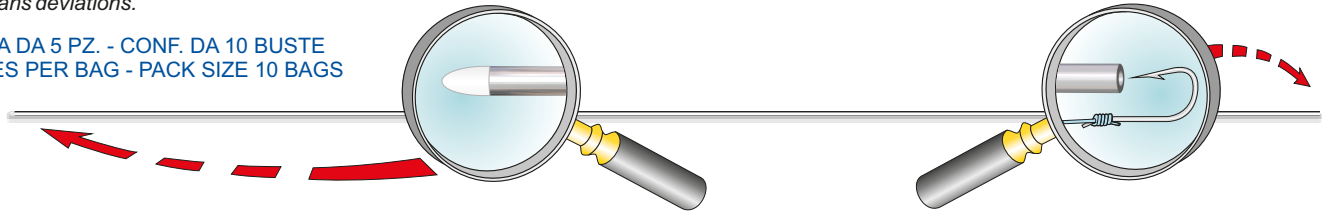

AGHI BIBI TESTA ROSSA PEANUT WORM NEEDLES



Aghi passafilo in acciaio inox con punta in materiale plastico super scorrevole. Il colore fluorescente visibilissimo della punta e la sua forma ogivale servono a prevenire deviazioni indesiderate della traiettoria di innesco.



Stainless steel peanut worm needle with line threading ring. The highly visible fluo colour of the plastic point and its ogival shape allow an easy threading of the worm without any deviation.



Aiguille passe-fil en acier inox avec pointe en plastique autolubrifiante. La couleur fluorescente très visible de la pointe et sa forme ogivale permettent un eschage rapide sans déviations. Idéale pour bibi.

Art.456 Ø 1,0 Lunghezza-Length 150 mm
Ø 1,0 Lunghezza-Length 200 mm

BUSTA DA 5 PZ. - CONF. DA 10 BUSTE
5 PIECES PER BAG - PACK SIZE 10 BAGS

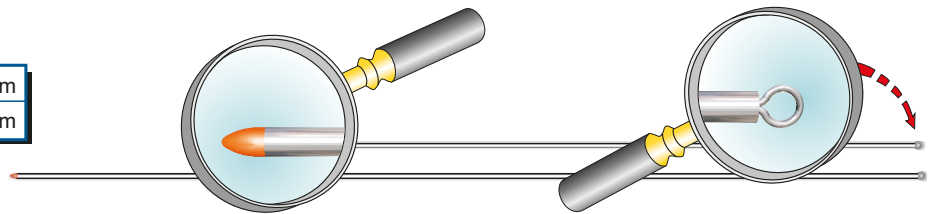

Art.249

AGO MICRO SPECIAL MICRO NEEDLE - MICRO AIGUILLE



ISTRUZIONI: 1) Infilare completamente il verme sul microago. 2) Togliere l'anima interna. 3) Mettere la punta dell'amo dentro il tubetto e fare scorrere il verme sull'amo. (Fig.A) OPPURE: 3 bis) Infilare il finale dentro il tubetto e fare scorrere il verme sul filo. (Fig.B).



INSTRUCTIONS: 1) Thread completely the worm on the micro needle. 2) Put the inner core out. 3) Insert the hook point into the tube and make the worm slide on the hook. (Picture "A") OR: 3b) Put the line into the tube and make the worm slide on the hook. (Picture "B").



MODE D'EMPLOI: 1) Insérer le ver sur la micro-aiguille. 2) Enlever la tige interne. 3) Mettre la pointe de l'hameçon dans le tube et faire glisser le ver sur l'hameçon. (Fig."A") OU BIEN: 3b) Insérer le bas de ligne dans le tube et faire glisser le ver sur la ligne et l'hameçon. (Fig."B")

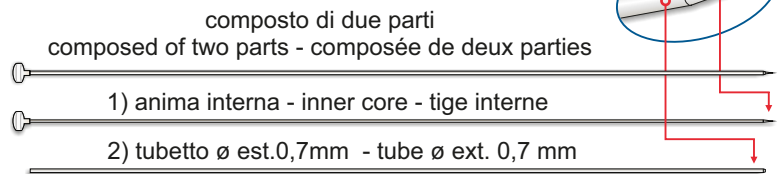

acciaio inox
stainless steel
acier inox

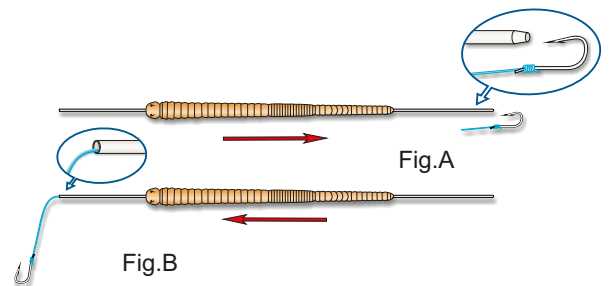

BUSTA DA 1 PEZZO - CONFEZIONE DA 5 BUSTE
1 PIECE PER BAG - PACK SIZE 5 BAGS

AGHI PLUSTEC PLUSTEC NEEDLES

Art.515 Ø 0,8 Lunghezza-Length 140 mm
Ø 0,8 Lunghezza-Length 200 mm



Aghi passafilo in acciaio inox realizzati con macchinari di alta precisione, sono ottimi per l'innesco del bibi. Stelo sottilissimo Ø 0,8 mm, punta arrotondata, gancino piccolissimo.



Stainless steel baiting needles manufactured with high precision machines. Ideal for peanut worm. Very thin stem Ø 0,8 mm, rounded shape point, very small hook.



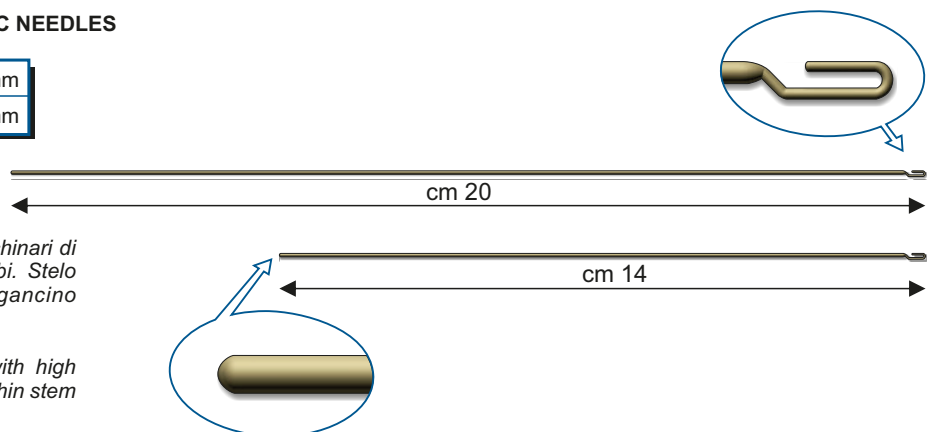

Aiguille passe-fil en acier inox produite par machines de haute précision. Tige très fin Ø 0,8 mm, pointe avec forme arrondie, crochet très petit. Idéale pour bibi.



BUSTA DA 3 PEZZI - CONFEZIONE DA 10 BUSTE
3 PIECES PER BAG - PACK SIZE 10 BAGS

Art.672 NEEDLE BOXES CM22

 Scatola componibile studiata per proteggere aghi fino a cm 20 di lunghezza. Materiale anti-urto. Coperchio con chiusura a scatto.

 Modular box designed to protect needles up to 20 cm in length. Shockproof material. Snap lid.

 Boîte modulaire étudiée pour protéger aiguilles jusqu'à cm 20 de longueur. Matériau antichoc. Couvercle avec fermeture à pression.

BUSTA DA 1 PEZZO - CONFEZIONE DA 10 BUSTE * 1 PIECE PER BAG - PACK SIZE 10 BAGS

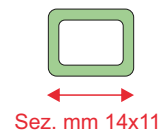

Art.673 NEEDLE BOXES CM22-32-42-52

 Scatole componibili studiate per proteggere aghi fino a 50 cm di lunghezza. Materiale anti-urto. Coperchio con chiusura a scatto. Combinazioni possibili: (2 scatole cm 20) - (1 scatola cm 20 + 1 scatola cm 30) - (1 scatola cm 10 + 1 scatola cm 40) - (1 scatola cm 50)

 Modular boxes designed to protect needles up to 50 cm in length. Shockproof material. Snap lid. Possible combinations: (2 boxes cm 20) - (1 box cm 20 + 1 box cm 30) - (1 box cm 10 + 1 box cm 40) - (1 box cm 50)

 Boîtes modulables étudiées pour protéger aiguilles jusqu'à cm 50 de longueur. Matériau antichoc. Couvercle avec fermeture à pression. Combinaisons possibles: (2 boîtes cm 20) - (1 boîte cm 20 + 1 boîte cm 30) - (1 boîte cm 10 + 1 boîte cm 40) - (1 boîte cm 50)

Sez. mm 14x11

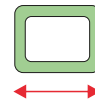

BUSTA DA 1 KIT - CONFEZIONE DA 10 BUSTE - 1 KIT PER BAG - PACK SIZE 10 BAGS

Art.676 NEEDLE KIT 20

 Kit di 6 aghi di tipo diverso forniti in una pratica scatolina in materiale anti-urto con chiusura a scatto. Il kit comprende: 1 ago Testa Rossa cm15, 2 aghi Testa Rossa cm20, 1 ago Testa Bianca cm20, 1 ago Tubolare Senza Punta cm 20, 1 ago Bibi Testa Rossa cm15.

 Kit of 6 different type needles supplied in a handy box in shockproof material with snap lid. The kit includes: 1 needle with red point cm 15, 2 needles with red point cm 20, 1 needle Ø 0,8 cm 20, 1 needle without point cm 20, 1 peanut worm needle with red point cm 15.

 Kit de 6 aiguilles de type différent fournies dans une boîte pratique en matériau antichoc avec fermeture à pression. Le kit comprend: 1 aiguille avec pointe rouge cm 15, 2 aiguilles avec pointe rouge cm 20, 1 aiguille avec pointe blanche cm 20, 1 aiguille sans pointe cm 20, 1 aiguille bibi avec pointe rouge cm 15.



SCATOLA DA 6 PEZZI - CONFEZIONE DA 5 SCATOLE * 6 PCS PER BOX - PACK SIZE 5 BOXES

Art.677 NEEDLE KIT 30

 Kit di 6 aghi di tipo diverso forniti in una pratica scatolina in materiale anti-urto con chiusura a scatto. Il kit comprende: 1 ago Testa Rossa cm20, 1 ago Testa Rossa cm30, 2 aghi Testa Bianca cm30, 1 ago Tubolare Senza Punta cm 30, 1 ago Bibi Testa Rossa cm20.

 Kit of 6 different type needles supplied in a handy box in shockproof material with snap lid. The kit includes: 1 needle with red point cm 20, 1 needle with red point cm 30, 2 needles Ø 0,8 cm 30, 1 needle without point cm 30, 1 peanut worm needle with red point cm 20.

 Kit de 6 aiguilles de type différent fournies dans une boîte pratique en matériau antichoc avec fermeture à pression. Le kit comprend: 1 aiguille avec pointe rouge cm 20, 1 aiguille avec pointe rouge cm 30, 2 aiguilles avec pointe blanche cm 30, 1 aiguille sans pointe cm 30, 1 aiguille bibi avec pointe rouge cm 20.



SCATOLA DA 6 PEZZI - CONFEZIONE DA 5 SCATOLE * 6 PCS PER BOX - PACK SIZE 5 BOXES

Art.200 **MICROGANCIO** STEEL MICRO SNAP - MINI AGRAFE

 Micro-moschettoni in acciaio inox per unire due fili in modo rapido e sicuro. Ottimo per il cambio rapido dei finali. Disponibile in 7 misure.

 Stainless steel micro-snap suitable to join two lines quickly. Available in 7 sizes.

 Mini-agrafe en acier inox pour jonction de fils. Disponible en 7 tailles.

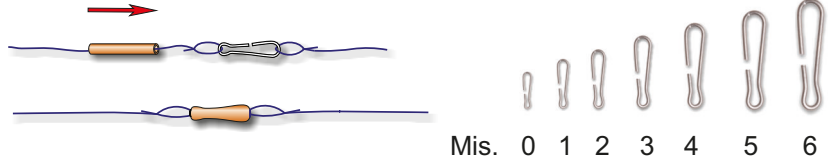

SCATOLINA DA 10 PZ. - CONF. DA 10 SCATOLINE
10 PIECES PER BOX - PACK SIZE 10 BOXES

Art.473 **SPEED SNAP**

 Moschettoni in acciaio inox ideali per sostituire facilmente e rapidamente piombi, segnalini, terminali etc. Prodotti in 4 misure.

 Stainless steel snap suitable to change easily and quickly lead, marker, rig etc. 4 sizes.

 Agrafe en acier inox pour la fixation rapide du plomb, marqueur, bas de ligne etc. 4 tailles.

Mis.	Strength	Strength	Weight
1	kg 7	lbs 15	gr 0,07
2	kg 16	lbs 35	gr 0,15
3	kg 25	lbs 55	gr 0,30
4	kg 46	lbs 102	gr 0,53



BU. DA 12 PZ. - CONF. DA 10 BUSTE
12 PCS PER BAG - PACK SIZE 10 BAGS

Art.172 **EASY SNAP**

 Moschettoni in acciaio inox per connettere rapidamente il terminale allo shock leader. Forniti completi di girelle. Disponibile in 3 misure.

 Stainless steel snap suitable to join shock leader to rig quickly. Supplied with swivels. Available in 3 sizes.

 Agrafe en acier inox pour la fixation rapide du bas de ligne au shock leader. Livrée avec émerillons. Disponible en 3 tailles.

BUSTA DA 6 PZ. - CONF. DA 10 BU.
6 PCS PER BAG - PACK SIZE 10 BAGS

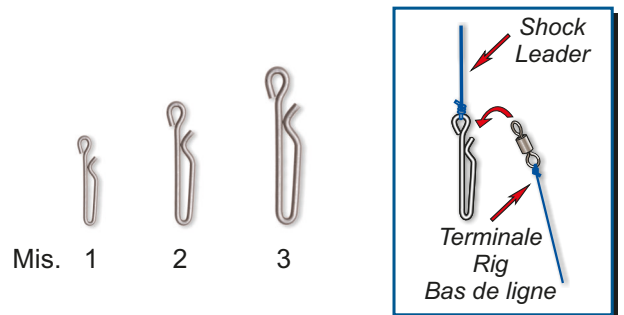

Art.221 **BAIT SNAP**

 Moschettoni in acciaio inox con duplice funzione: aggancio rapido del piombo e bait clip. Disponibile in 2 misure.

 Dual function stainless steel snap: quick lead connector and bait clip. Available in 2 sizes.

 Agrafe en acier inox avec double fonction: fixe plomb et bait clip. Disponible en 2 tailles.

BUSTA DA 6 PZ. - CONF. DA 10 BU.
6 PCS PER BAG - PACK SIZE 10 BAGS

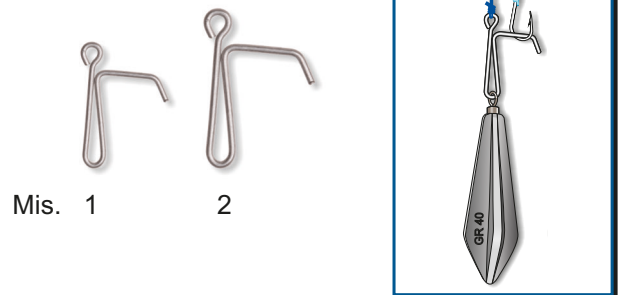

Art.715 **PRO LINK** NEW 2020

 Attacco rapido in acciaio inox di forma molto sottile per agevolarne il passaggio negli anelli della canna. Ideale per il collegamento del trave allo shock leader o del piombo terminale. Fornito con speciali tubetti di forma cilindrica, con spessore sottile ed estremità conica priva di appigli. I vari colori permettono il mimetismo od una perfetta visibilità dell'attacco. I tubetti inoltre hanno dei micro rilievi per agevolarne la presa. Prodotto in tre misure di diversa potenza.

 Stainless steel fast snap. Its thin shape allows easy passing through rod guides. Ideal to connect the main line to the shock leader or to the lead. Supplied with special cylindrical tubes, with thin thickness and smooth conical end. The various colors allow camouflage or perfect visibility of the snap. The tubes also have micro-reliefs to make them easier to grip. Produced in 3 sizes with different strength.

 Agrafe en acier inox à fixation rapide. Sa forme mince permet un passage facile dans les anneaux. Idéal pour connecter la ligne à le bas de ligne ou au plomb. Livré avec tubes spéciaux cylindriques, avec une épaisseur mince et extrémité conique lisse. Les différentes couleurs permettent le camouflage ou une visibilité parfaite de l'agrafe. Les tubes ont aussi des micro-reliefs pour les rendre plus faciles à saisir. Disponible en 3 tailles de différente résistance.

BUSTA DA 6 PZ. - CONF. DA 10 BU.
6 PCS PER BAG - PACK SIZE 10 BAGS

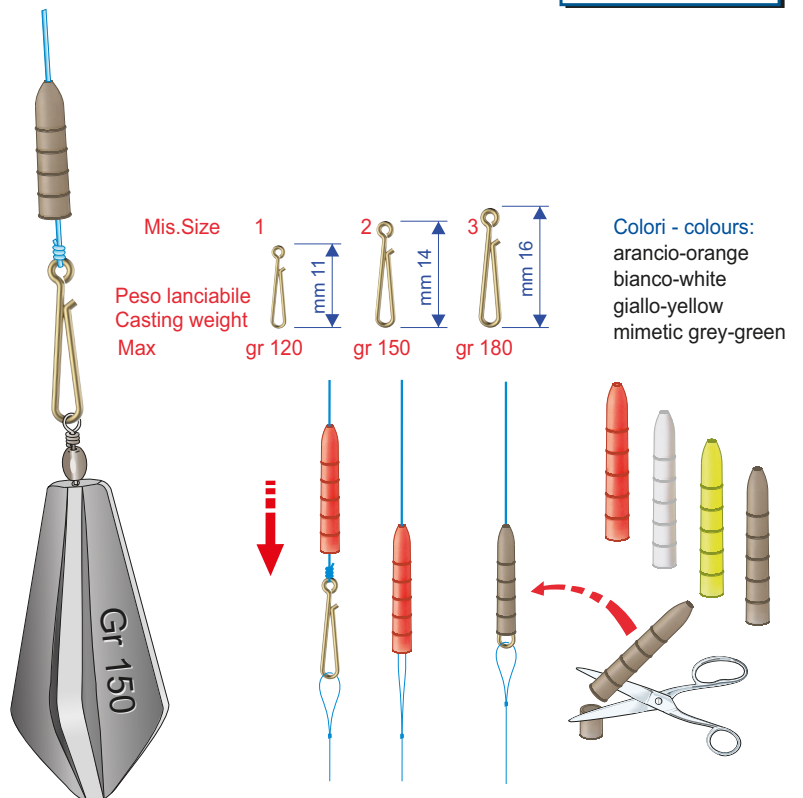

Art.250 BAIT CLIP

 Dispositivo per l'aggancio dell'esca durante il lancio. Istruzioni: introdurre il monofilo nella traccia del pezzo "A" e tenendolo in tensione inserire la guida del pezzo "A" nella sede del pezzo "B" con la clip in posizione "2". Bloccare il bait clip sul monofilo portando la clip in posizione "1". Disponibile in 3 misure.

 Bait clip, device to secure bait during cast. Instructions: introduce the line in piece "A" groove and, keeping the line taut, insert piece "A" slide into piece "B" way, with the clip in position "2". Move the clip to position "1" to lock the bait clip in the desired position. Available in 3 sizes.

 Système de retenue de l'hameçon et de l'appât au moment de lancer. Mode d'emploi: introduire la ligne dans la trace de la pièce "A" et, en la tendant, insérer la glissière de la pièce "A" dans la pièce "B", avec la clip dans la position "2". Mettre le bait clip dans la position désirée et le bloquer en réglant la clip dans la position "1". Disponible en 3 tailles.

BUSTA DA 10 PZ. - CONF. DA 10 BU. * 10 PCS PER BAG - PACK SIZE 10 BAGS

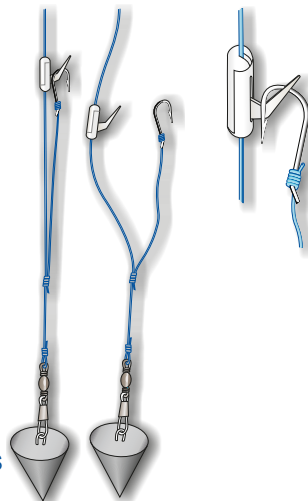

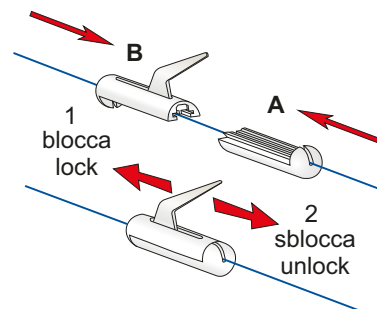

Mis. sizes	filo - line	
	ø min.	ø max
1	0,15	0,35
2	0,40	0,60
3	0,60	0,80



Art.607 TELEFERICA ROCK FISHING CONNECTOR

 Aggancio in acciaio inox studiato per la pesca a teleferica. Si inserisce rapidamente sulla lenza madre grazie alla speciale spirale e garantisce un'eccezionale scorrevolezza. Resistenza 22 kg.

 Stainless steel connector perfect for rock fishing. It clips quickly on the main line thanks to its special spring and slides very well. Strength 22 kg.

 Clipot en acier inox étudié pour le montage téléphérique. Il s'accroche sur le corps de ligne rapidement grâce au spécial ressort et coulisse très bien. Résistance 22 kg.

BUSTA DA 2 PEZZI - CONFEZIONE DA 10 BUSTE
2 PIECES PER BAG - PACK SIZE 10 BAGS

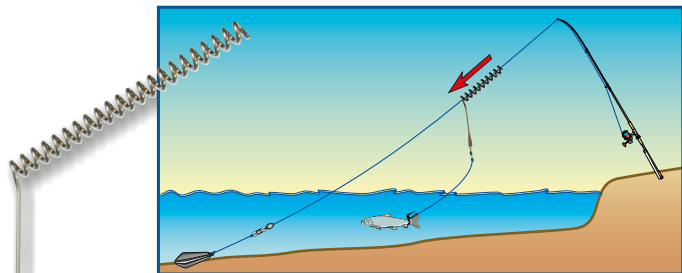

Art.608 TELEFERICA 25

HEAVY ROCK FISHING CONNECTOR

 Aggancio in acciaio inox pesante studiato per la pesca a teleferica in fondali medio-alti. Si inserisce rapidamente sulla lenza madre grazie alla speciale spirale e garantisce un'eccezionale scorrevolezza. Peso 25 gr. Resistenza 22 kg.

 Heavy stainless steel connector perfect for the rock fishing, suitable for deeper water. It clips quickly on the main line thanks to its special spring and slides very well. Weight 25 grams. Strength 22 kg.

 Clipot en acier inox lourd étudié pour le montage téléphérique, apte pour profondeurs supérieures. Il s'accroche sur le corps de ligne rapidement grâce au spécial ressort et coulisse très bien. Poids 25 grammes. Résistance 22 kg.

BUSTA DA 2 PEZZI - CONFEZIONE DA 10 BUSTE
2 PIECES PER BAG - PACK SIZE 10 BAGS

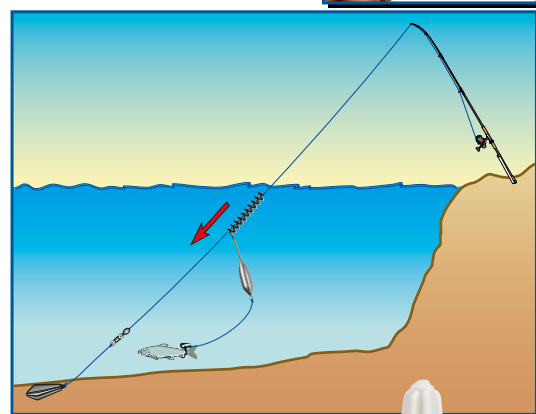
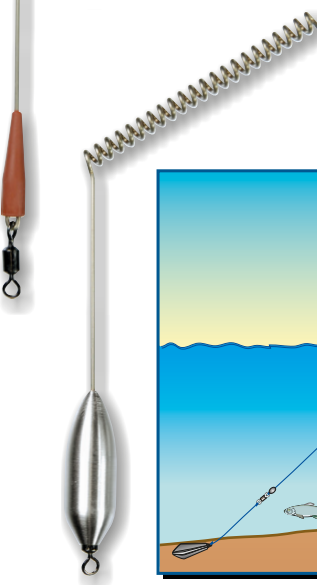

Art.518 COLLA CYANOX CIANOX GLUE cont.10 gr

 Collante cianoacrilico a essiccazione rapida indispensabile per l'incollaggio di fili nylon, fluorocarbon e trecciati. Ideale inoltre per realizzare montaggi con perline, applicare apicali e tubolari su vettini, consolidare nodi, costruire mosche artificiali, tube flies etc. etc. Boccetta con dosatore contagocce molto preciso. Prodotto deperibile da conservare in frigo.

 Instant cyanoacrylate rig glue suitable for: joining nylon, fluorocarbon and braided lines; mounting beads on the line; fixing connectors and bushes on the tips; strengthening knots; tying flies and tube flies etc. etc. Bottle with very accurate applicator. Perishable product store in the fridge.

 Colle cyanoacrylate à prise ultra rapide pour: coller fils en nylon, fluorocarbon et tresses; fixer les perles sur la ligne, bloquer fixe ligne et tulipes sur les scions; consolider nœuds; montage de mouches et tube flies etc.etc. Flacon doseur compte-gouttes très précise. Produit périssable conserver au réfrigérateur.

BUSTA DA 1 PEZZO - CONF. DA 10 PEZZI * 1 PIECE PER BAG - PACK SIZE 10 PIECES





Art.519 PERLINE FORO CALIBRATO BEADS WITH CALIBRATED BORE



Ø filo	0,30	0,35	0,40	0,45	0,50	0,60	0,80	1,00	1,20
--------	------	------	------	------	------	------	------	------	------

 Perline in materiale plastico resistentissimo con fori calibrati al diametro del filo. Appositamente studiate per l'incollaggio su monofili in nylon, fluorocarbon e trecciati nella realizzazione di montaggi senza nodi.

 High resistance plastic material beads with bores calibrated to the diameter of the line. Created specifically to be glued on the nylon monofilaments or fluorocarbon lines and on the braids, in order to make the rigs without knots.

 Perles en matériau plastique très résistant avec trous calibrés au diamètre du fil. Exprès étudiées pour le collage sur monofil nylon, fluorocarbon et tresse. Permettent la réalisation de montages sans nœuds.

BUSTA DA 24 PZ. - CONF. DA 10 BU. * 24 PCS PER BAG - PACK SIZE 10 BAGS

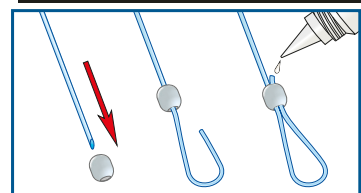
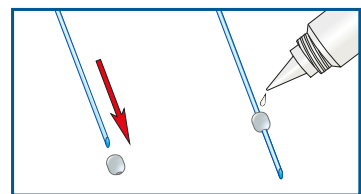

Art.449 **SUPPORTO DI MONTAGGIO** LINE REST

 Supporto per sostenere il nylon o il trecciato durante le operazioni di montaggio del terminale. Composto da una basetta in alluminio che lo rende stabile e da inserti in gomma blocca-filo.

 Line rest to make your rigs easily. Suitable for monofilament or braid. It is composed of a stable aluminium frame with rubber parts lock-line.

 Support pour soutenir le nylon ou la tresse, idéal pour le montage du bas de ligne. Il est composé d'une structure stable d'aluminium avec parties bloqué-fil en caoutchouc.

BUSTA DA 1 PZ. - CONF. DA 10 BU. * 1 PIECE PER BAG - PACK SIZE 10 BAGS



Art.65 **STONFO BEADS MATCH**

PERLINE DOPPIO FORO PER FINALI - DOUBLE BORE BEADS - PERLES DOUBLE TROU

Mis. Ø mm	Ø main line		Ø rig	
	min	max	min	max
1,8	0,16	0,30	0,08	0,18
2,2	0,20	0,35	0,10	0,20
3	0,25	0,40	0,10	0,25

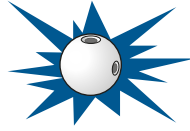

Fori intersecanti
Crossing bores
Trous croisés

BUSTA DA 24 PEZZI - CONF. DA 10 BUSTE
24 PIECES PER BAG - PACK SIZE 10 BAGS

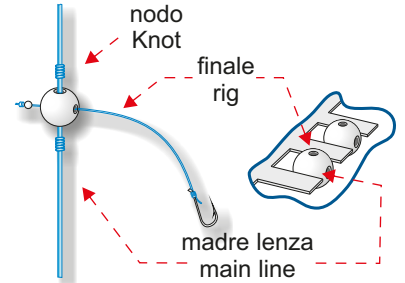

Art.453 **STONFO BEADS MATCHPLUS**

PERLINE DOPPIO FORO PER FINALI - DOUBLE BORE BEADS - PERLES DOUBLE TROU

Mis. Ø mm	Ø main line	Ø rig
	max	max
2,0	0,35	0,25
2,6	0,40	0,30

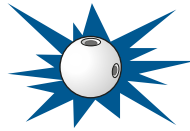

Fori non intersecanti
Not crossing bores
Trous pas croisés

BUSTA DA 24 PEZZI - CONF. DA 10 BUSTE
24 PIECES PER BAG - PACK SIZE 10 BAGS

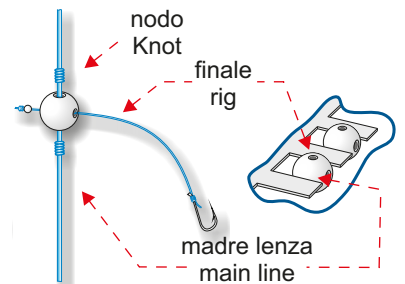

Art.66 **STONFO BEADS DEEP**

PERLINE DOPPIO FORO PER FINALI - DOUBLE BORE BEADS - PERLES DOUBLE TROU

Mis. Ø mm	Ø main line	Ø rig
	max	max
3,3	0,80	0,40
4	0,90	0,60
6	1,30	0,80
8	1,70	0,90
10	2,40	1,40

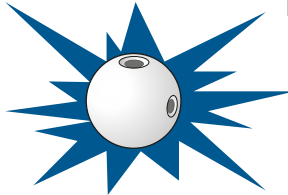

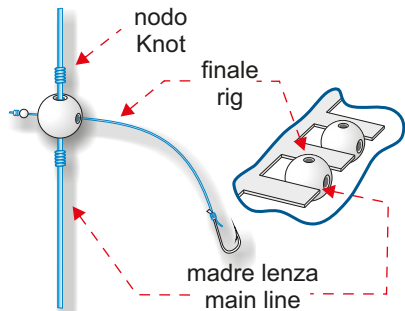

Fori non intersecanti
Not crossing bores
Trous pas croisés

BUSTA DA 24 PEZZI - CONF. DA 10 BUSTE
24 PIECES PER BAG - PACK SIZE 10 BAGS



CLIP BEADS



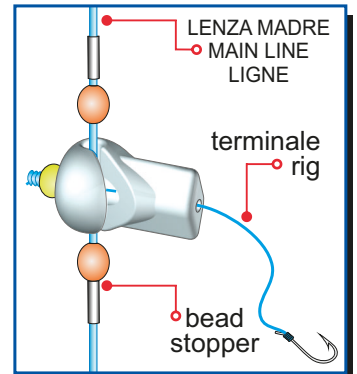
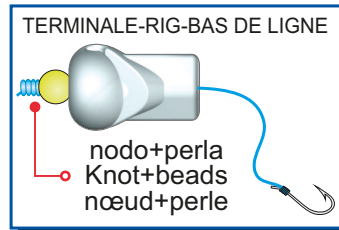

 Perline per l'aggancio rapido dei finali alla lenza madre. Esse hanno un foro per il terminale e una traccia trasversale in cui, con una certa pressione, viene inserita la lenza madre. La loro speciale forma rende più semplice l'operazione di aggancio-sgancio. Prodotte in materiale resistentissimo trasparente.

 Fast connector beads for a quick change of the rig from the main line. They have a hole for the rig and one transversal cut where insert, with a certain pressure, the main line. Their special shape facilitates the put and release operation. Produced with clear strong material.



 Perles pour l'accrochage rapide du bas de ligne. Elles ont un trou pour le bas de ligne et un logement transversal où insérer, avec une certaine pression, la ligne. Leur forme spéciale facilite l'opération de fixation et décrochage. Produites en matériau transparent très résistant.



Art.582 **CLIP BEADS**

Size	1	2	3	4
real size scala 1:1				

Art.583 **CLIP BEADS MAXI**

	
5	6

Mis. SIZE	Ø madre lenza min	max	terminale Ø max
1	0,16	0,25	0,20
2	0,25	0,40	0,35
3	0,40	0,55	0,40
4	0,55	0,70	0,50
5	0,70	0,90	0,80
6	1,00	1,40	1,20

BUSTA DA 20 PEZZI - CONF. DA 10 BUSTE
20 PIECES PER BAG - PACK SIZE 10 BAGS

BUSTA DA 24 PEZZI - CONF. DA 10 BUSTE
24 PIECES PER BAG - PACK SIZE 10 BAGS

Art.346 FAST CONNECTOR LIGHT SPECIAL PATERNOSTER TYPE LIGHT

 Modelli Light più leggeri permettono un cambio rapido del finale. La libertà di rotazione in tutte le direzioni ed il tubetto di deriva eliminano il rischio di ingarbugliamenti. Hanno una notevole resistenza in rapporto alle loro ridotte dimensioni. Disponibili in 3 misure.

 Light model Fast connector and anti-tangle bead for a quick change of the rig. Rotating freedom and derivation tube reduce any possibility of entanglement. Available in 3 sizes.

 Clipot connecteur ultra-léger pour l'accrochage rapide du bas de ligne. La liberté de double rotation et le tube de dérivation réduisent la possibilité d'embrouillement. Disponible en 3 tailles.

BUSTA DA 2 PZ. - CONF. DA 5 BU. * 2 PCS PER BAG - PACK SIZE 5 BAGS

**beach legering
bolentino**

Lbs.	8	12	16
Grammi	0,025	0,030	0,038

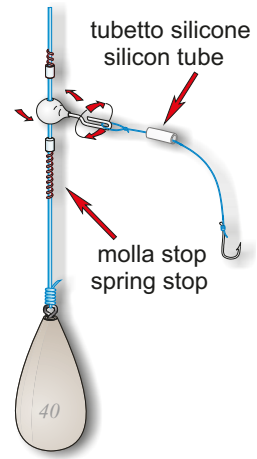

Art.269 FAST CONNECTOR SPECIAL PATERNOSTER



 La soluzione ideale per un cambio rapido del finale! La libertà di rotazione in tutte le direzioni ed il tubetto di deriva eliminano il rischio di ingarbugliamenti. Hanno una notevole resistenza in rapporto alle loro ridotte dimensioni.

 Fast connector and anti-tangle bead for a quick change of the rig. Rotating freedom and derivation tube reduce any possibility of entanglement.

 Clipot connecteur pour l'accrochage rapide du bas de ligne. La liberté de rotation et le tube de dérivation réduisent la possibilité d'embrouillement.

**surf casting
bolentino**

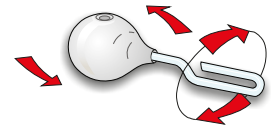

BUSTA DA 2 PEZZI - CONF. DA 10 BUSTE
2 PIECES PER BAG - PACK SIZE 10 BAGS

Art.244 ATTACCO MICROMATCH MICRO RIG CONNECTOR

Mis. Size	00	0
inox Ø mm	0,30	0,35

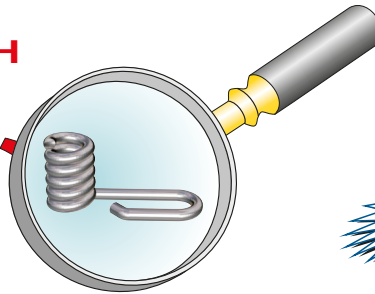

**beach legering
bolentino**

 Dispositivo in acciaio inox di dimensioni microscopiche ottimo per il cambio rapido del terminale.

 Microscopic stainless steel connectors for a quick change of the rig.

 Système microscopique en acier inox pour l'accrochage rapide du bas de ligne.

BUSTA DA 6 PZ. - CONF. DA 10 BU
6 PCS PER BAG - PACK SIZE 10 BAGS



Art.229-1 ATTACCO MICRO PER FINALI MICRO PATERNOSTER



 Dispositivo in acciaio inox per il cambio rapido dei finali per bolentino, beach legering e surf casting.

 Stainless steel twisted connector for a quick change of the rig. Suitable for drift fishing, beach legering and surf casting.

 Système en acier inox pour l'accrochage rapide du bas de ligne. Apte pour le montage en dérivation pour pêche à fond et surf-casting.

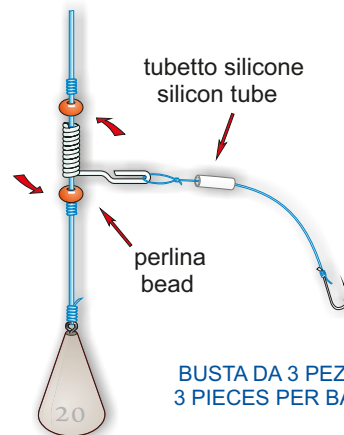

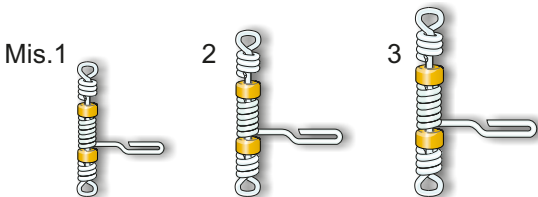

BUSTA DA 3 PEZZI - CONF. DA 10 BUSTE
3 PIECES PER BAG - PACK SIZE 10 BAGS

Art.260 TRIPLO ATTACCO TRIPLE PATERNOSTER



 Dispositivo in acciaio inox per il cambio rapido dei finali per bolentino, beach legering e surf casting. Molto efficace e semplice nel montaggio.

 Stainless steel twisted connector for a quick change of the rig. Suitable for drift fishing, beach legering and surf casting. Very efficient and easy to use.

 Système en acier inox pour l'accrochage rapide du bas de ligne. Apte pour le montage en dérivation pour pêche à fond et surf-casting. Efficace et très pratique.

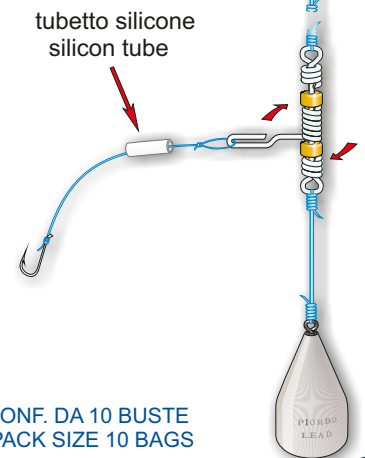

BUSTA DA 2 PEZZI - CONF. DA 10 BUSTE
2 PIECES PER BAG - PACK SIZE 10 BAGS

Art.262 **ATTACCO BIG**

BIG PATERNOSTER



Ideale per Bolentino di profondità. La libertà di rotazione e il tubetto di deriva riducono la possibilità di ingarbugliamenti. La sua grande resistenza permette l'utilizzo di finali con cavetto d'acciaio.



Ideal for deep fishing. Rotating freedom and derivation tube reduce any possibility of entanglement. Thanks to its excellent resistance you can use a steel wire rig.



Idéal pour la pêche profonde. La liberté de double rotation et le tube de dérivation réduisent la possibilité d'embrouillement. Sa excellente résistance permet l'utilisation d'hameçons montés avec câble en acier.

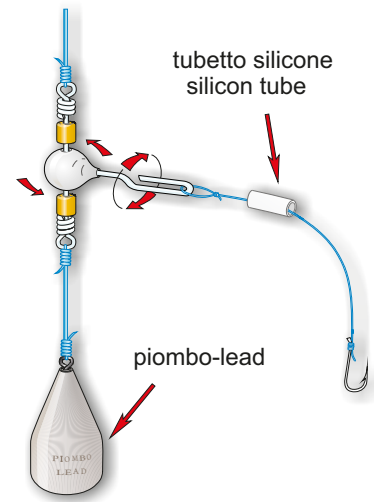
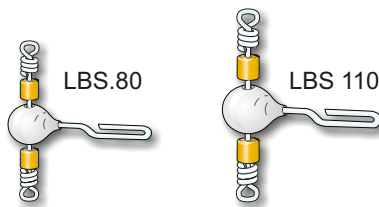

BUSTA DA 2 PEZZI - CONF. DA 6 BUSTE * 2 PIECES PER BAG - PACK SIZE 6 BAGS

Art.268 **FAST CONNECTOR LONG ARM**

DEEP FISHING PATERNOSTER

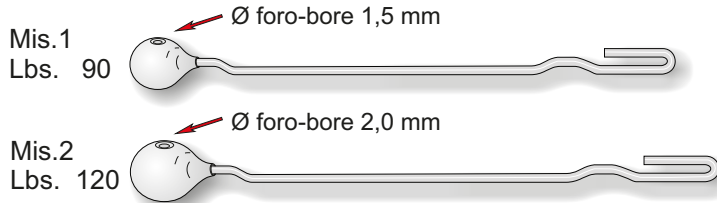

Studiati per la pesca di grande profondità. La libertà di rotazione in tutte le direzioni ed il braccetto lungo di deriva eliminano il rischio di ingarbugliamenti. Hanno una grandissima resistenza in rapporto alle loro dimensioni.



Fast connector "Long arm" for deep fishing. Rotating freedom and derivation tube reduce any possibility of entanglement. Excellent resistance.



Clipot connecteur "Long arm" pour pêche de grande profondeur. La liberté de double rotation et le tube de dérivation réduisent la possibilité d'embrouillement. Excellente résistance

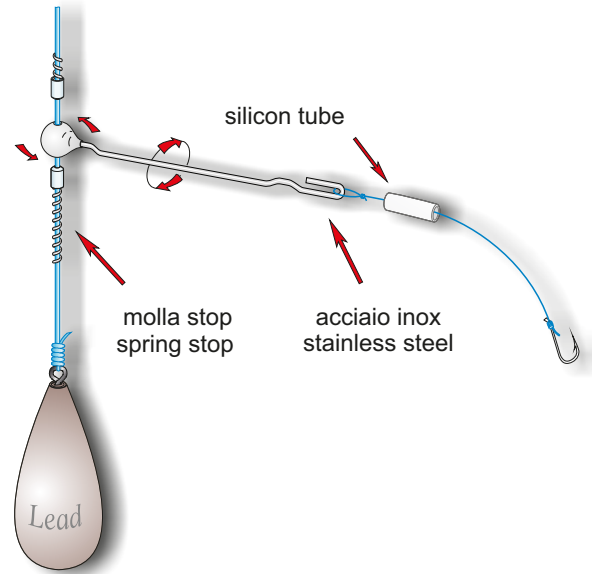

BUSTA DA 2 PEZZI - CONF. DA 10 BUSTE * 2 PIECES PER BAG - PACK SIZE 10 BAGS

Art.474 **BRACCIOLI RIG CONNECTORS**

Mis.	Resistenza	Strength
1	12 kg	26 Lbs
2	20 kg	44 Lbs
3	43 kg	95 Lbs



Dispositivo in acciaio inox per il montaggio e cambio rapido dei finali. La molla è rifinita con boccole in materiale scorrevole speciale "salva-filo".



Stainless steel connector for a quick change of the rig, with special bushes protect-line.



Clipot anti vrilleur en acier inox pour l'accrochage rapide du bas de ligne. Le ressort est muni des embouts spéciaux protège-fil.

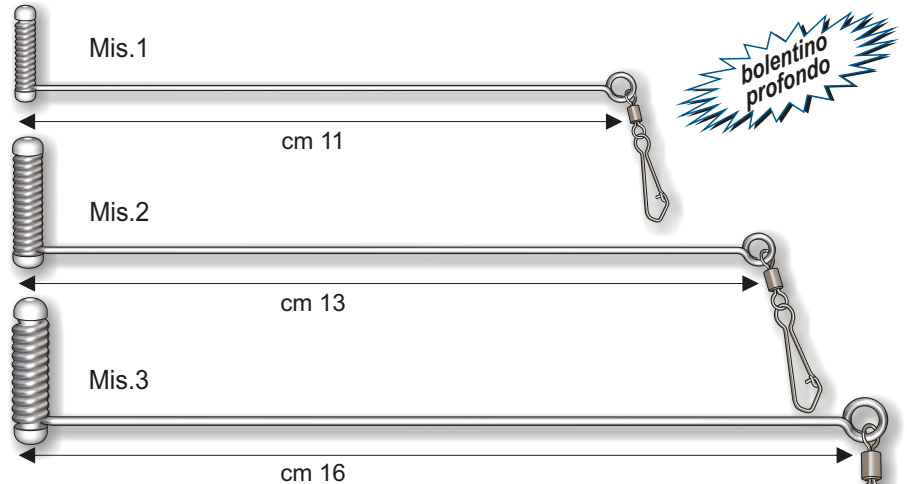

bolentino profondo

BUSTA DA 2 PEZZI - CONF. DA 10 BUSTE * 2 PIECES PER BAG - PACK SIZE 10 BAGS

Art.663 **ATTACCO ROTO SNAP** ROTO SNAP CONNECTOR



Attacco scorrevole molto robusto, ideale per pasturatori e piombi di peso elevato. La girella ed il moschettone sono collegati ad una molla rotante in acciaio inox che funziona da ammortizzatore per prevenire rotture.



Very strong running connector, ideal for heavy feeders and leads. The swivel and the snap are joined to a rotating stainless steel spring that works as a shock absorber to prevent breakages.



Connecteur coulissant très robuste, idéal pour amorçoirs et plombs lourds. L'émerillon et l'agrafe sont accrochés à un ressort rotatif en acier inox qui fonctionne comme un amortisseur pour éviter ruptures.

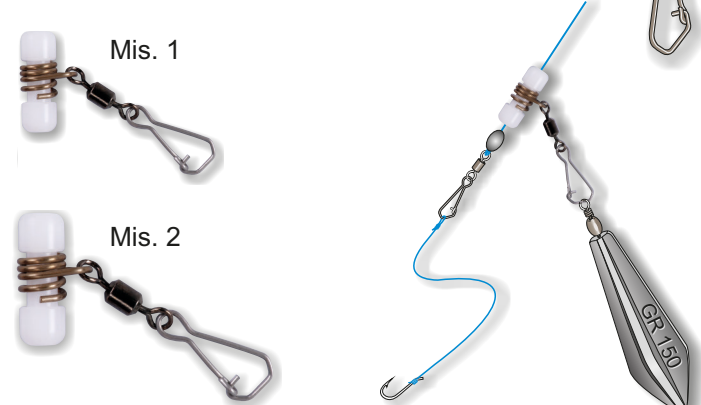

BUSTA DA 3 PZ. - CONFEZIONE DA 10 BUSTE
3 PIECES PER BAG - PACK SIZE 10 BAGS

Art.276 **MOLLA DI STOP** SPRING STOP

 Garantisce un sicuro e forte bloccaggio di qualsiasi accessorio senza danneggiare o indebolire il filo. Di dimensioni ridottissime puo' essere riutilizzata molte volte.

 Spring to stop the sliding accessories on the fishing line.

 Ressort bloqueur très efficace pour stopper tout article coulissant. N'abîme pas le fil.

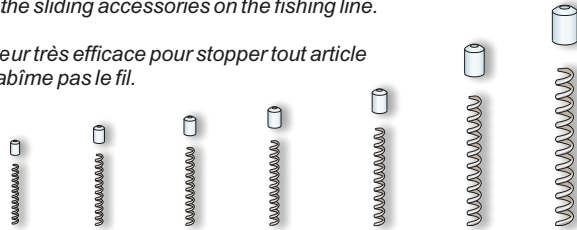

Mis.	0	1	2	3	4	5	6
Ø Line	0,20	0,30	0,40	0,50	0,60-70	1,00	1,20

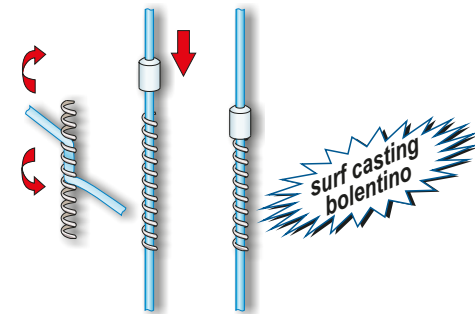



surf casting
bolentino

BUSTA DA 6 PEZZI - CONF. DA 10 BUSTE
6 PIECES PER BAG - PACK SIZE 10 BAGS

Art.510 **PASTURATORE BARCA**

BOAT FEEDER

 Pasturatore da barca preciso ed efficiente munito di un sistema di regolazione della forza di apertura. Riempire di pastura, sardine etc.etc., bloccare il coperchio e calarlo dalla barca con un cordino rigido alla profondità desiderata. Tirare bruscamente il cordino per permettere l'apertura e lo scaricamento del pasturatore. Peso a vuoto kg 1 - Capienza Lt 0,7.

 Accurate and efficient boat feeder equipped with adjustment device of the opening strength. Fill the feeder with groundbait, sardines etc.etc., lock the lid and lower it from the boat with a rigid cord to the desired depth. Pull brusquely the cord to open and discharge the feeder. Weight kg 1 - Capacity Lt 0,7.

 Amorçoir bateau précis et efficace muni de régleur de la force d'ouverture. Remplir l'amorçoir d'amorce, sardines etc.etc., bloquer le couvercle et le plonger dans l'eau avec une corde rigide à la profondeur désirée. Tirer brusquement la corde pour permettre l'ouverture et le déchargement du amorçoir. Poids kg 1 - Capacité Lt 0,7

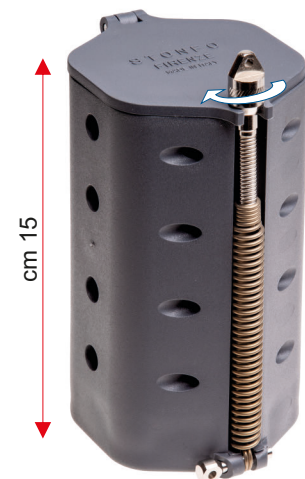
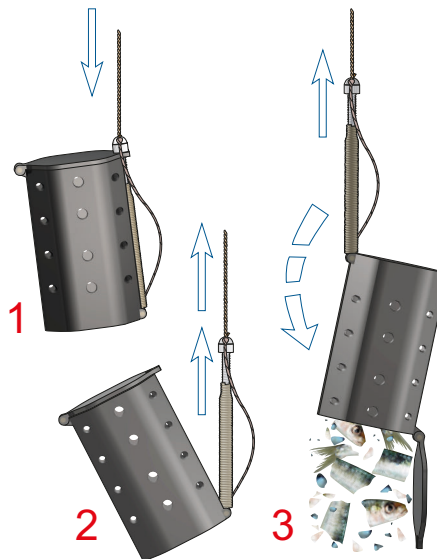



Regolazione della forza di apertura
Adjustment of the opening strength
Réglage de la force d'ouverture

CONFEZIONE DA 1 PEZZO - PACK SIZE 1 PIECE

Art.703 **PASTURATORE BIG BARCA**

BOAT FEEDER BIG

 Pasturatore da barca ad apertura rapida. La sua capienza di Lt 1,7 ed il suo peso di Kg 1,4 lo rendono idoneo per la pesca su fondali di oltre 50 metri. Funzionamento: riempire il pasturatore, bloccare il coperchio e calarlo dalla barca con un cordino rigido alla profondità desiderata. Tirare bruscamente il cordino per permettere l'apertura e lo scaricamento del pasturatore.

 Boat feeder with quick opening system. Its capacity of Lt 1.7 and its weight of Kg 1.4 make it suitable for fishing in depths over 50 meters. Instructions: Fill the feeder, lock the lid and lower it from the boat with a rigid cord to the desired depth. Pull brusquely the cord to open and discharge the feeder.

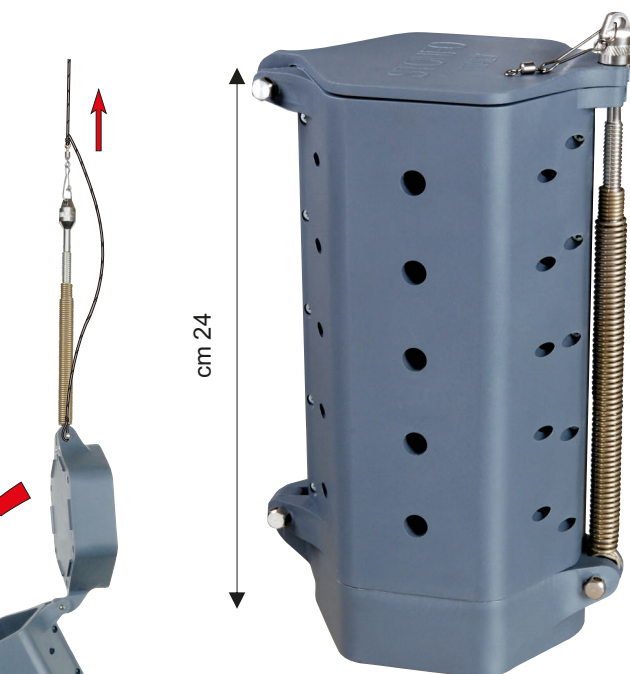

 Amorçoir bateau à ouverture rapide. Sa capacité de Lt 1,7 et son poids de Kg 1,4 le rendent approprié pour la pêche à des profondeurs de plus de 50 mètres. Fonctionnement: remplir l'amorçoir, bloquer le couvercle et le plonger dans l'eau avec une corde rigide à la profondeur désirée. Tirer brusquement la corde pour permettre l'ouverture et le déchargement du amorçoir.

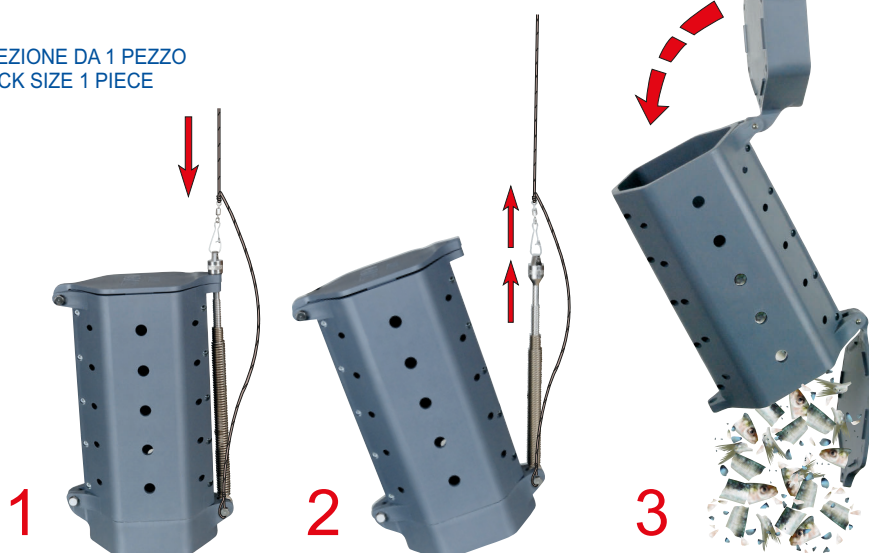

CONFEZIONE DA 1 PEZZO
PACK SIZE 1 PIECE



LAMPADE FLASH FLASH LAMP

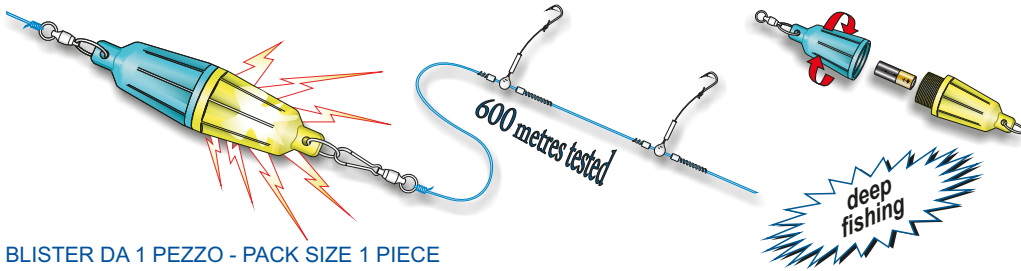

-  Lampada flash per pesca di profondità, drifting, traina. Utile come segnalatore luminoso per la subacquea, campeggio, etc. Disponibile nei colori bianco e fotoluminescente. Fornita con due batterie omaggio.
-  Flash lamp for deep fishing, drifting, trolling. Also useful for diving, camping, etc. Available in white and phosphorescent colours. Two batteries included.
-  Lampe flash pour pêche profonde, à soutenir, à la traîne. Utile aussi pour la subaquatique, camping, etc. Couleurs disponibles blanc et phosphorescent. Livrée avec deux piles.



BLISTER DA 1 PEZZO - PACK SIZE 1 PIECE





Art. 103 CHIAVI PER LAMPADA FLASH FLASH LAMP SPANNERS

-  Chiavi per agevolare l'apertura e la chiusura della Lampada Flash art. 77.
-  Spanners to open-close the art. 77 Flash Lamp easily.
-  Clés pour fermer et ouvrir plus facilement la Lampe Flash art. 77.



BUSTA DA 2 PEZZI - PACK SIZE 2 PIECES

Art. 79 REDANCE PER TERMINALI THIMBLES - COSSES

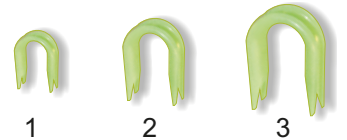

-  Redance in materiale plastico per proteggere il terminale nell'asola a contatto con il moschettone. Disponibili in 3 misure.
-  Nylon thimbles recommended to protect big game-rigs. Available in 3 sizes.
-  Cosses en nylon pour protéger les parties sensibles entre la boucle et l'émerillon. Disponibles en 3 tailles.



Mis. 1 2 3

BUSTA DA 10 PEZZI - CONFEZIONE DA 10 BUSTE
10 PIECES PER BAG - PACK SIZE 10 BAGS

Art. 80 REDANCE A MOLLA SPRING THIMBLES RESSORT PROTEGE BOUCLE

-  Molle in acciaio inox per proteggere il terminale nell'asola a contatto con il moschettone. Disponibili in 4 misure.
-  Stainless steel springs recommended to protect big game-rigs. Available in 4 sizes.
-  Ressort en acier inox pour protéger les parties sensibles entre la boucle et l'émerillon. Disponible en 4 tailles.

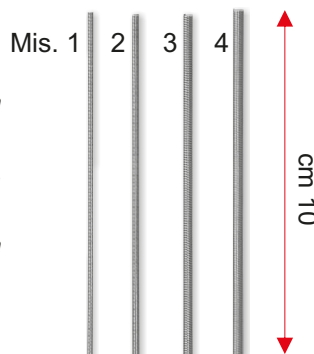

Mis. size	Ø interno mm internal Ø	Ø esterno mm external Ø
1	1,2	2,0
2	1,5	2,3
3	2,0	3,0
4	2,5	3,5

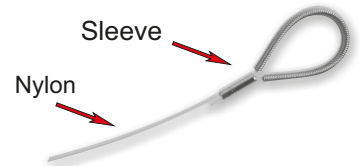



BUSTA DA 10 PEZZI - CONFEZIONE DA 10 BUSTE
10 PIECES PER BAG - PACK SIZE 10 BAGS

Art. 489 PINZE PER SPLIT RINGS SPLIT RING PLIERS - PINCES À ANNEAUX BRISÉS

-  Pinze di alta qualità studiate appositamente per aprire gli anelli spaccati ed inserire o togliere agevolmente ami, girelle, etc. Misura 1: Per anelli anche piccolissimi di media potenza. Misura 2: Per anelli di grande potenza.
 - Impugnatura anatomica in resina resistentissima
 - Punta in acciaio temprato
 - Dimensioni compatte (Lunghezza cm 13)
 - Peso ridotto

Mis. Size	Ø interno anello Ring internal Ø	La pinza apre l'anello di Plier open the ring of
1	Min Ø 2,5 mm	Max 1 mm
2	Min Ø 4,5 mm	Max 2 mm

-  High quality split ring pliers are designed for opening split rings and change out easily your hooks, swivels etc.etc. Size 1: Suitable for light and medium strength split rings. Size 2: Suitable for extra strong split rings.
 - Anatomic strong resin handle
 - Hardened steel tips
 - Compact design (Length cm 13)
 - Lightweight

-  Pincés d'haute qualité spécialement conçues pour ouvrir les anneaux brisés et remplacer hameçons, émerillon etc.etc. Taille 1: Pour anneaux brisés très petits de force moyenne. Taille 2: Pour anneaux brisés très forts.
 - Poignée anatomique en plastique très résistante
 - Mors en acier trempé
 - Petites (Longueur cm 13)
 - Légères

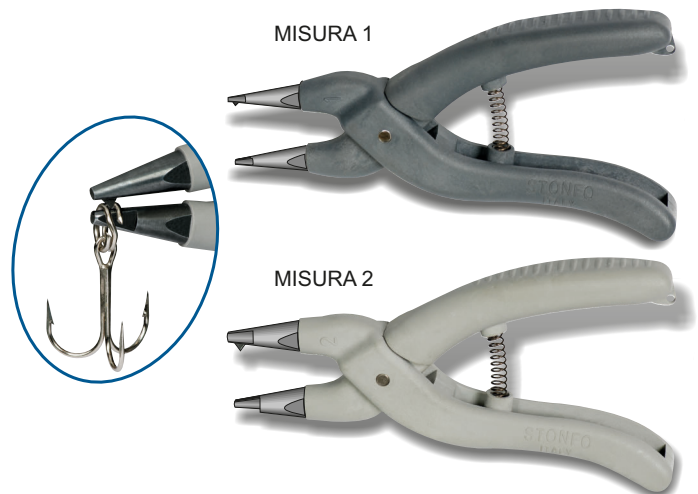

BUSTA DA 1 PZ. - CONF. DA 5 PZ. * 1 PIECE PER BAG - PACK SIZE 5 BAGS

Art.204

SPLIT RINGS LIGHT TYPE

ANELLI APERTI LEGGERI - ANNEAUX BRISÉS LÉGERS

Mis.Size	0	1	2	3	4
Ø int.mm	2,6	3,0	4,0	5,0	7,0
strength-res.	kg 5	kg 10	kg 25	kg 17	kg 13
weight-peso	gr 0,02	gr 0,04	gr 0,12	gr 0,15	gr 0,20

acciaio inossidabile **NEW 2020**
stainless steel
acier inox



Mis. 0 1 2 3 4

BUSTA DA 20 PEZZI - CONFEZIONE DA 10 BUSTE
20 PIECES PER BAG - PACK SIZE 10 BAGS

Art.468

SPLIT RINGS STRONG TYPE

ANELLI APERTI EXTRA FORTI - ANNEAUX BRISÉS EXTRA FORTS

Mis.Size	1	2	3	4
Ø int.mm	4,5	5,5	6,5	7,5
strength-res.	kg 30	kg 40	kg 50	kg 60
weight-peso	gr 0,24	gr 0,40	gr 0,65	gr 0,85

acciaio inossidabile
stainless steel
acier inox

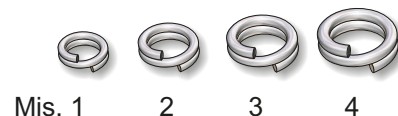

Mis. 1 2 3 4

BUSTA DA 10 PZ. - CONF. DA 10 BU. * 10 PCS PER BAG - PACK SIZE 10 BAGS

Art.465

PRO JIGGING SOLID RINGS

Mis.	Ø int.	Resistenza
1	mm 5	Strength 30 kg
2	mm 6	Strength 50 kg
3	mm 7	Strength 80 kg



Mis. 1 2 3

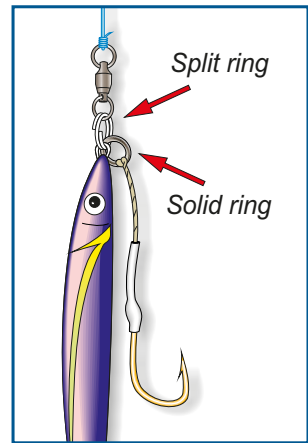

Anelli in metallo pieno perfettamente levigati per il montaggio degli ami sull'esca artificiale.



Perfectly smoothed solid metal rings. Ideal to assemble the hooks on the jiggng lures.



Anneaux complets en métal parfaitement émoussées idéaux pour le montage des hameçons sur leurres.

BUSTA DA 10 PZ. - CONF. DA 10 BU. * 10 PCS PER BAG - PACK SIZE 10 BAGS

Art.435

NO NODO NO KNOT

- Mis.1 Line Max 0,20
- Mis.2 Line Max 0,25
- Mis.3 Line Max 0,30
- Mis.4 Line Max 0,40
- Mis.5 Line Max 0,50
- Mis.6 Line Max 0,80



"No Nodo" è un moschettono rapido speciale che permette, senza fare nodi, di collegare al monofilo o al trecciato l'esca artificiale, l'amo, il finale, il piombo etc. etc. mantenendo così inalterato il carico di rottura del filo. Prodotto in acciaio inox in 6 differenti misure per ogni tipo di pesca.



Special fast snap, suitable to attach without knot to your fishing line (monofilament or braid) lure, hook, rig, weight etc. etc. It is made of stainless steel in 6 different sizes for any kind of fishing.



Agrafe inox spéciale, idéale pour accrocher à la ligne (fil ou tresse) sans faire nœuds, leurres, hameçons, bas de ligne, plomb etc. etc. Disponible en 6 tailles pour tous les types de pêche.

BUSTA DA 10 PZ. - CONF. DA 10 BU. * 10 PCS PER BAG - PACK SIZE 10 BAGS

Art.572

MOSCHETTONI R TYPE

R TYPE SNAPS



Moschettoni in acciaio inox adatti per ogni tipo di pesca. La loro forma arrotondata permette la massima libertà di movimento all'esca artificiale.



Stainless steel snap suitable for any kind of fishing. The rounded shape allows greater freedom of movement to the lures.



Agrafe en acier inox idéale pour tous les types de pêche. La forme arrondie permet une complète liberté de mouvement des leurres.

BUSTA DA 10 PZ. - CONF. DA 10 BU. * 10 PCS PER BAG - PACK SIZE 10 BAGS

GUARANTEED STRENGTH

Mis. Size	1	2	3	4	5
Strength kg	10	16	38	45	85

Art.573

MOSCHETTONI V TYPE

V TYPE SNAPS



Moschettoni in acciaio inox adatti per ogni tipo di pesca. Il loro design conico è particolarmente adatto alla connessione tra il filo trecciato e il finale.



Stainless steel snaps suitable for any kind of fishing. Their conical shape is essential when connecting braided line to the trace.



Agrafes en acier inox idéales pour tous les types de pêche. Leur forme conique est particulièrement indiquée pour la jonction entre le fil tressé et le nylon.

BUSTA DA 10 PZ. - CONF. DA 10 BU. * 10 PCS PER BAG - PACK SIZE 10 BAGS

GUARANTEED STRENGTH

Mis. Size	1	2	3	4	5
Strength kg	12	22	40	55	95

Art.636 QUICKLINK ROUNDED SHAPE

- Moschettoni in acciaio inox ad attacco rapido. La loro forma arrotondata permette la massima libertà di movimento all'esca artificiale.
- Stainless steel snaps for quick change. The rounded shape allows greater freedom of movement to the lures.
- Agrafes en acier inox à fixation rapide. Leur forme arrondie permet une complète liberté de mouvement des leurres.

BUSTA DA 10 PZ. - CONF. DA 10 BUSTE * 10 PCS PER BAG - PACK SIZE 10 BAGS

Art.638 QUICKLINK ELLIPTICAL SHAPE

- Moschettoni in acciaio inox ad attacco rapido. Il loro design ellittico permette una connessione in linea con la lenza madre oltre ad una resistenza notevolmente superiore.
- Stainless steel snaps for quick change. Their elliptical shape allows a perfectly in-line connection with the mainline and a greater strength.
- Agrafes en acier inox à fixation rapide. Leur forme elliptique permet une jonction avec la ligne parfaitement en axe et une résistance considérablement supérieure.

BUSTA DA 10 PZ. - CONF. DA 10 BUSTE * 10 PCS PER BAG - PACK SIZE 10 BAGS

Art.637 WIRELINK CLIP

- Moschettoni in acciaio inox ad attacco rapido appositamente studiati per essere utilizzati con cavetto o filo in acciaio. La loro forma è da una parte arrotondata per permettere la massima libertà di movimento dell'artificiale mentre dalla parte opposta è stretta per avere una connessione di ridotte dimensioni e il cavetto perfettamente in linea con il moschettone. Forniti con tubetto termoretraibile della misura idonea.
- Stainless steel snap for quick change, ideal to connect monostrand wire or tress wire. The Wirelink Clip has a rounded part to allow greater freedom of movement to the lure, while the opposite side is narrow to have a small size connection with the wire perfectly in-line. Supplied complete with shrinkable tube of the appropriate size.
- Agrafes en acier inox à accrochage rapide étudiées pour être utilisées avec fil d'acier tressé ou monofil d'acier. Les Wirelink Clips ont une partie arrondie pour permettre une complète liberté de mouvement des leurres tandis que la partie opposée est étroite pour avoir une jonction très petite avec le fil d'acier parfaitement en axe. Livrées avec gaine rétractable de taille appropriée.

BUSTA DA 6 PZ. - CONF. DA 10 BU. * 6 PCS PER BAG - PACK SIZE 10 BAGS

Art.701 LURE SNAPS



Mis. Size	1	2	3
Strength kg	5	8	14
Hook Size	14-8	6-1	1/0-6/0

GUARANTEED STRENGTH

- Permettono un cambio rapido di mosche ed artificiali senza fare nodi ed accorciare ogni volta il terminale. Prodotti in acciaio inox molto resistente in 3 misure.
- They allow to change quickly flies and lures without tying knots and shorten the dropper every time. Produced in high strength stainless steel. Available in 3 sizes.
- Ces agrafes permettent un changement rapid de mouches et leurres sans faire noeuds et raccourcir chaque fois le bas de ligne. Produites en acier inox de haute resistance en 3 tailles.

BUSTA DA 5 PEZZI - CONF. DA 10 BUSTE * 5 PIECE PER BAG - PACK SIZE 10 BAGS

Art.101 DISTANZIALI PER ESCHE ARTIFICIALI SPACER TUBES FOR LURES - ENTRETOISE POUR LEURRES

Mis.	Ø ext.	Line max
1	mm 2,8	1,0 mm
2	mm 4,5	1,5 mm
3	mm 6,2	2,0 mm



- Distanziale per esche artificiali. Componibile in lunghezza è ottimo per distanziare correttamente l'amo dalla testina dell'esca artificiale e per proteggere il filo dai denti del pesce. Disponibile in 3 misure.
- Spacer for lures. It can be composed in length to have a correct distance between the hook and the lure head. It protects the line from the fish teeth. Available in 3 different sizes.
- Tube-entretoise pour leurres. Composé en longueur il sert à tenir la distance correcte entre l'hameçon et la tête du leurre. Il protège la ligne des dents du poisson. Disponible en 3 tailles.

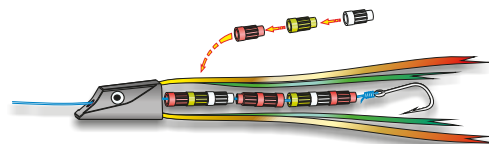

BUSTA DA 24 PEZZI - CONFEZIONE DA 10 BUSTE
24 PIECES PER BAG - PACK SIZE 10 BAGS



GUARANTEED STRENGTH

Mis. Size	0	1	2	3	4
Strength kg	4	6	9	18	34



GUARANTEED STRENGTH

Mis. Size	0	1	2	3	4
Strength kg	7	10	16	30	48



GUARANTEED STRENGTH

Mis. Size	0	1	2	3
Strength kg	4	10	18	25
Strength lbs	9	22	40	55



Mis.Size 1	Gr 1 - 3	gr 1 + 1 + 1
Mis.Size 2	Gr 3,5-9,5	gr 3,5 + 3 + 3
Mis.Size 3	Gr 10 - 26	gr 10 + 8 + 8

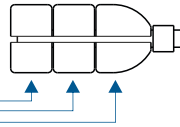

Italy Bullet a peso variabile, ideale per la pesca con esche silicomiche sia con Texas rig che con Carolina rig. Il Bullet è composto da tre parti in ottone che, grazie ad una traccia longitudinale, possono essere tolte o aggiunte sul filo senza tagliarlo. Disponibile in tre diverse misure per una variabilità di peso da 1 a 26 grammi.

UK Bullet with variable weight, ideal for fishing with soft lures both with Texas rig and Carolina rig. The bullet is composed of three brass parts that, thanks to a longitudinal slot, can be removed or added on the line without cutting it. Available in 3 sizes for a weight range from 1 to 26 grams.

France Bullet avec poids variable, idéal pour la pêche avec leurres en silicone soit avec Texas rig que Carolina rig. Le bullet est composé de trois parties que, grâce à une fente longitudinale, peuvent être enlevés ou ajoutés sur la ligne sans la couper. Disponible en 3 tailles pour une variabilité de poids de 1 à 26 grammes.



BUSTA DA 1 PEZZO - CONF.DA 10 BUSTE
1 PER BAG - PACK SIZE 10 BAGS

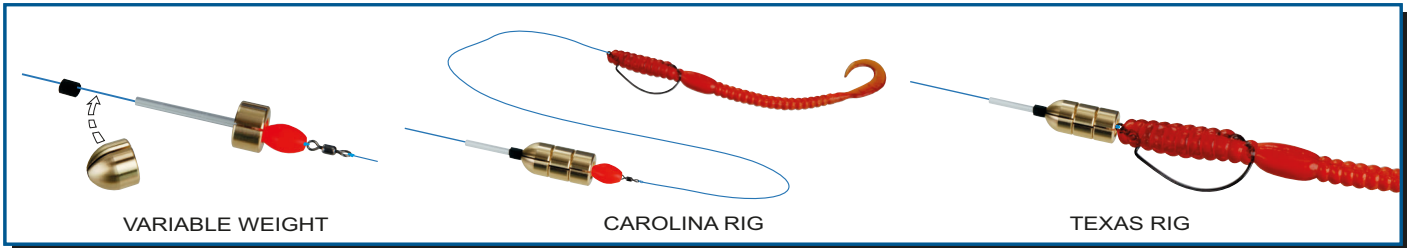

Art.621 **ATTACCO PER ESCHE SILICONICHE**
SOFT LURE SPRINGS - RESSORTS POUR LEURRES SOUPLES

Italy Mollettine in acciaio inox, si avvitano semplicemente nell'esca silicomiche, permettendo un attacco sicuro dell'amo senza danneggiare l'artificiale. Indicate nei montaggi tipo Texas rig, Wacky rig e Neko rig. Utilissime inoltre per applicare all'esca, nella posizione voluta, pesi, sferette adescanti, ami supplementari etc.etc.

UK Stainless steel springs, easy to screw in the silicone lure, they allow a secure attachment of the hook without damaging the bait. Ideal for Texas rig, Wacky rig and Neko rig. Very useful for applying weights, attractor spheres or additional hooks in the desired position on the bait.

France Ressorts en acier inox, sont vissés simplement dans le leurre en silicone, pour une fixation sûre de l'hameçon dans les montage Texas rig, Wacky rig et Neko rig sans endommager le leurre. Très utiles aussi pour appliquer sur le leurre, dans la position voulu, poids, billes attractives, hameçons supplémentaires etc.

BUSTA DA 6 PEZZI - CONF. DA 10 BUSTE
6 PIECES PER BAG - PACK SIZE 10 BAGS

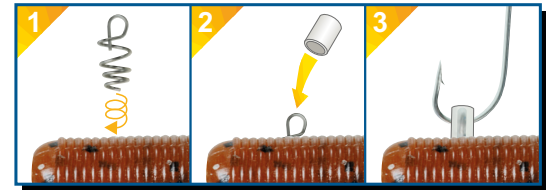

Art.548 **TIRANODO** TIGHTEN KNOT

Italy Accessorio che permette di serrare agevolmente il nodo anche su filo grosso e rigido.

UK Useful tool that allows to tighten knot easily on big and rigid line too.

France Permet de serrer facilement le nœud aussi sur fil gros et rigide.

BUSTA DA 1 PEZZO - CONFEZIONE DA 10 BUSTE
1 PIECE PER BAG - PACK SIZE 10 BAGS

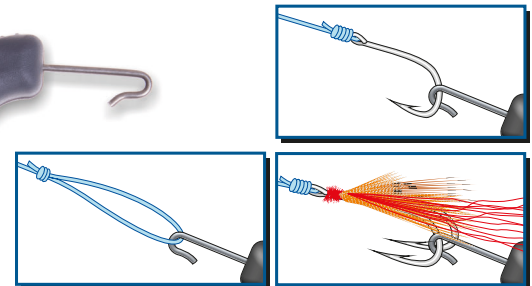

Art.102 **SALVA ANCORETTE** TREBLE HOOK SAVERS - PROTÈGE HAMEÇON TRIPLE



BUSTA DA 10 PEZZI - CONFEZIONE DA 10 BUSTE
10 PIECES PER BAG - PACK SIZE 10 BAGS

Mis.Size	1	2	3	4
ancoretta	min 16	min 10	min 3	min 1
hook-treble	max 12	max 4	max 1	max 3/0

ANELLI PER FINALI

LURE AND TRACE HOLDER - ANNEAUX POUR BAS DE LIGNE



Pratici e sicuri anelli portafinali muniti di speciali cursori blocca-filo. Disponibili in due diverse misure.



Lure and trace holder supplied with special lock line sliders. Available in two different sizes.



Anneaux pour bas de ligne munis de speciales curseurs bloque-fil. Deux tailles.

Art.191	Mis.1	Small Size Ø 135 mm
Art.192	Mis.2	Big Size Ø 168 mm

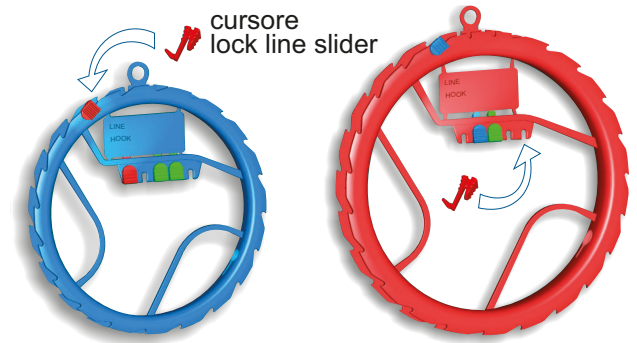
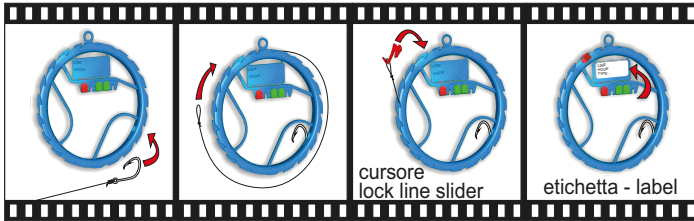

BUSTA DA 1 PZ. - CONF. DA 10 BU.
1 PIECE PER BAG - PACK SIZE 10 BAGS

Art.569

SERBIDORA BARCA

BAIT TRAY BOAT



Serbidora in materiale plastico resistentissimo perfettamente smussato e privo di angoli taglienti. Munita di nicchia per contenere vaschette porta-esche e minuteria varia in modo stabile e sicuro. Molte altre caratteristiche importanti fanno di questa serbidora un vero e proprio completo banco di lavoro indispensabile su ogni barca. Dimensioni cm 39x28. Fornita completa di palo snodato inox, morsetto e giunto regolabile.



Bait station designed to meet the many needs of fisherman. Its structure, in durable plastic, is perfectly rounded and has no sharp edges. The compartment can hold various bait boxes or tools in a stable position. Other important features make this bait tray a well equipped working station necessary in every kind of boat. Dimension 39x28 cm. Supplied with adjustable stainless steel base, clamp and angle lock connector.



Plateau porte appâts étudié pour les pêcheurs plus exigeants. Sa structure en plastique est très solide et parfaitement arrondie. Il est muni de logement pour boîtes à êches et accessoires. Autres considérables caractéristiques font de ce plateau un complet banc de travail indispensable sur le bateau. Dimensions 39x28 cm. Fourni avec base orientable en acier inox, dispositif de serrage et tête orientable.



BUSTA DA 1 PEZZO
1 PIECE PER BAG

Art.570

PALO SNODATO INOX

ADJUSTABLE STAINLESS STEEL BASE



Palo in acciaio inox da inserire nel portacanne della barca. Munito di testa orientabile con vite universale in metallo.



Stainless steel base for boat rod holders. Adjustable head with universal metal screw.



Base en acier inox pour porte canne. La tête orientable est munie de vis universelle en métal.

BUSTA DA 1 PEZZO - 1 PIECE PER BAG

Chiavetta di prerogolazione
Pre-adjustment key
Clef de pré réglage

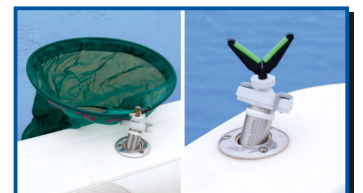

Art.41

APPOGGIA CANNE DA BARCA TIPO M

ROD REST FOR BOAT TYPE M - SUPPORT CANNE BATEAU M

 Appoggicanna da barca in materiale resistente agli urti e con inserti in gomma. Questo modello si applica direttamente alla murata della barca per mezzo di una placchetta con filettatura standard.

 Strong plastic, corrosion free boat rod rest, fitted with soft rubber inserts and mounting plate and screws.

 Support canne bateau anticorrosion avec elements en caoutchouc et platine de fixation. Livré avec vis de blocage.



BUSTA DA 1 PEZZO - CONFEZIONE DA 10 BUSTE
1 PIECE PER BAG - PACK SIZE 10 BAGS

Art.42

APPOGGIA CANNE DA BARCA TIPO T

ROD REST FOR BOAT TYPE T - SUPPORT CANNE BATEAU T

 Appoggicanna da barca con inserti in gomma, prodotto con materiale resistente agli urti e alla corrosione. Questo modello si applica alla battagliola della barca per mezzo di un morsetto con filettatura standard.

 Strong plastic, corrosion free boat rod rest, fitted with soft rubber inserts. Clamps onto any rail giving a safe, secure position to the rod.

 Support canne bateau avec elements en caoutchouc et dispositif de serrage sur balcon.





BUSTA DA 1 PEZZO - CONFEZIONE DA 10 BUSTE
1 PIECE PER BAG - PACK SIZE 10 BAGS

Art.433

EASY SNAP MAXI

 Aggancio rapido per finali, in acciaio inossidabile, ideale per la pesca con filaccioni e palamito.

 Stainless steel fast snap, suitable for longline and deep fishing.

 Agrafe inox, idéale pour accrocher, dégrafer rapidement les avançons. Idéale pour les palangres et la pêche de profondeur.

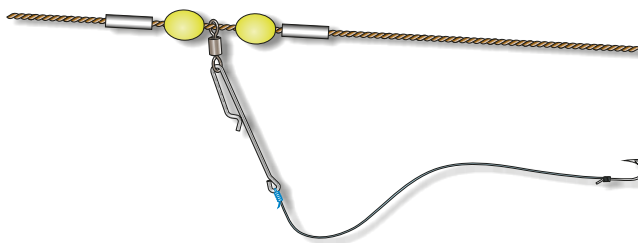

Mis.	1	2	3
Strength kg	20	25	30

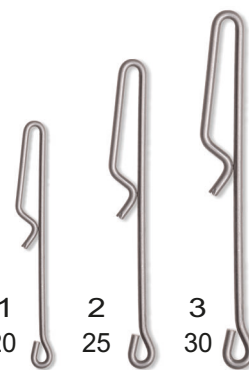

BUSTA DA 50 PEZZI - CONFEZIONE DA 5 BUSTE
50 PIECES PER BAG - PACK SIZE 5 BAGS

SPEEDY LOCK PER PALAMITO

SPEEDY LOCK FOR LONGLINE FISHING

Art.224P

Misura piccola per trave da 0,60 a 1,00 mm
Small size for line from 0,60 to 1,00 mm
Petit modèle pour fil du 0,60 au 1,00 mm

Art.224G

Misura grande per trave da 1,00 a 1,80 mm
Big size for line from 1,00 to 1,80 mm
Grand modèle pour fil du 1,00 au 1,80 mm

 Dispositivo per la pesca con palamito, pratico nel montaggio ed estremamente maneggevole, consente un rapido aggancio-sgancio del finale. Prodotto in 2 misure per trave da mm 0,60 a mm 1,80. La doppia rotazione di 360° del finale rispetto al trave evita il rischio di aggrovigliamenti. Montato a scatto senza bisogno di fare nodi può essere riutilizzato molte volte.

 Device for longline fishing. Easy to assemble and extremely handy, allows a quick change of the snood. Produced in 2 different sizes for nylon from mm 0,60 to mm 1,80. The double 360° rotation of the snood around the main line avoids tangles. Snap mounted without any knot, it can be used several times.

 Système de clipot pour la palangre, facile a monter et très pratique, permet l'accrochage rapide des avançons. Il existe en deux tailles pour s'adapter aux diamètres de fil (tresse ou monofil) du 0,60 au 1,80 mm. La double rotation à 360° de l'avançon autour de la ligne-mère réduit la possibilité d'emmêlement. Encliqueté sans faire nœuds, il peut être utilisé plusieurs fois.

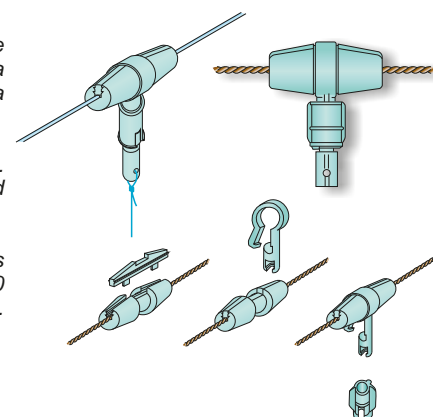

BUSTE DA 54 PEZZI
54 PIECES PER BAG

Art.224-3 NOTTOLINO PER SPEEDY LOCK

SNOOD CONNECTOR FOR SPEEDY LOCK



Connettore per Speedy Lock
 Snood connector for Speedy Lock
 Fixe avançon pour Speedy Lock



BUSTE DA 60 PEZZI - 60 PIECES PER BAG

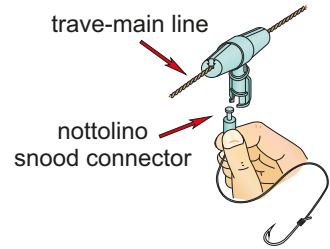

GABBIETTE PORTAESCA PER CEFALOPODI

FRAME SQUID LURES - TURLUTTES CAGE

Art.219	Mis.Mini - Small Size	Peso fisso-Fixed weight gr 5
Art.220	Mis.Mini - Small Size	Peso-Weight gr 5 + 15
Art.171	Mis.standard-Big Size	Peso fisso-Fixed weight gr 5
Art.173	Mis.standard-Big Size	Peso-Weight gr 5 + 25



L'innovativa struttura colorata ed elastica di queste gabbiette permette un rapido bloccaggio della sardina o altro tipo di esca rendendole più catturanti. Disponibili in 2 diverse grandezze con peso fisso o intercambiabile. Colori assortiti.



Squid lure with special plastic colored clear frame. Allows to lock the fish bait easily. Available in 2 different sizes and with fixed or interchangeable weights. Miscellaneous colors.



Turlutte spéciale pour la pêche à les céphalopodes. Avec sa structure flexible et colorée permet de bloquer facilement un poisson mort (sardine) ou un appât (morceau de seiche). Disponible en 2 tailles et avec poids fixe et interchangeable. Couleurs assorties.

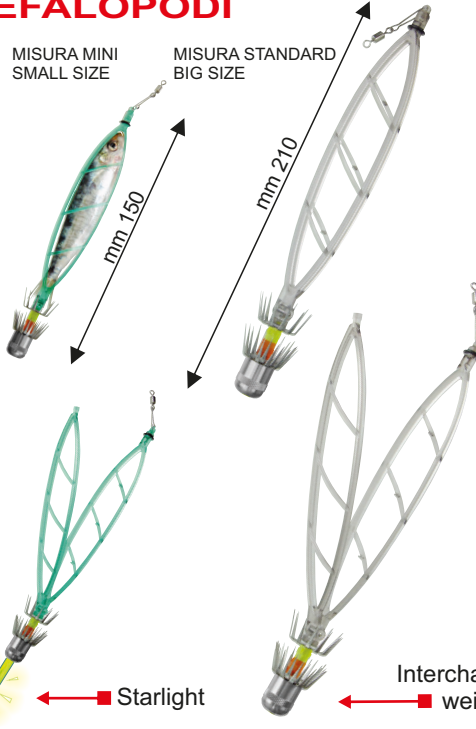

BLISTER DA 1 PEZZO - CONFEZIONE DA 10 PEZZI
 1 PIECE PER BAG - PACK SIZE 10 PIECES

TOTANARE FLASH LUMINOUS SQUID LURES-TURLUTTES LUMINEUSES

Art.175B	BIANCA - WHITE
Art.175F	FOTOLUMINESCENTE - PHOSPHORESCENT



Questo artificiale per cefalopodi emana una luce flash intermittente potentissima. Munito di speciali corone inox brevettate. Viene fornito completo di batteria 12 volt alcalina mod.A23. Disponibile in 2 versioni: art. 175B Luce bianca, art. 175F fotoluminescente.



Luminous intermittent flash lures for squid fishing. Equipped with special patented squid hooks. Battery included 12 volt alkaline mod.A23. Available in 2 versions: item 175B White colour, item 175F phosphorescent colour.



Turlottes lumineuses clignotantes (flash) pour la pêche aux céphalopodes, équipées de spéciales couronnes brevetées. Livrées avec pile 12 volts type A23. Couleurs disponibles: art.175B blanche, art.175F phosphorescente.



CONFEZIONE DA 1 PEZZO - PACK SIZE 1 PIECE

Art.399 ASTA PER CANNOLICCHI RAZOR SHELL PRONG - GRAPPIN À SOLEN

LUNGHEZZA - LENGTH CM100 CONFEZIONE DA 10 PEZZI - PACK SIZE 10 PIECES



Art.303 TUBETTO GOMMA FLUO FLUORESCENT SOFT TUBING



Tubetto in gomma morbida adatto alla costruzione e personalizzazione di esche artificiali. Disponibile in 3 diversi diametri in buste da 1 metro. Colori assortiti fluorescenti.



Soft rubber tubing suitable for lure making. Available in 3 diameters in 1 meter coils. Miscellaneous fluo colours.



Tube en gomme souple idéal pour le montage des leurres. Disponible en 3 tailles. Sachet de 1 metre en couleurs fluo assorties.

Mis.Size 1	Ø int. mm 1,0 Ø est. mm 2,0
Mis.Size 2	Ø int. mm 1,5 Ø est. mm 3,0
Mis.Size 3	Ø int. mm 2,0 Ø est. mm 4,0

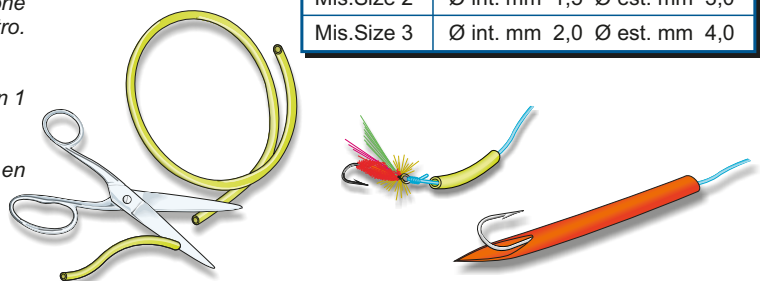

BUSTA DA 1 METRO - CONFEZIONE DA 10 BUSTE
 1 METRE PER BAG - PACK SIZE 10 BAGS

Art.303-1 TUBETTO GOMMA FOSFORO

PHOSPHORESCENT SOFT TUBING



*Tubetto in gomma morbida fosforescente.
 Phosphorescent soft rubber tubing.
 Tube en gomme souple phosphorescente.*

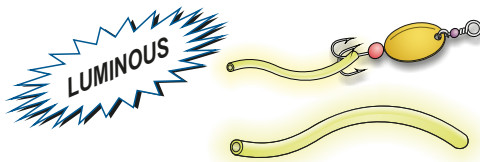

Mis.Size 1	Ø int. mm 1,0 Ø est. mm 2,0
Mis.Size 2	Ø int. mm 1,5 Ø est. mm 3,0
Mis.Size 3	Ø int. mm 2,0 Ø est. mm 4,0

BUSTA DA 1 METRO - CONFEZIONE DA 10 BUSTE
1 METER PER BAG - PACK SIZE 10 BAGS

TUBETTO GOMMA FLUO A METRI

FLUORESCENT SOFT RUBBER TUBING



*Tubetto in gomma morbida in matasse da 25 mt.
 Colori rosso, giallo, nero.
 Fluorescent soft rubber tubing in 25 metres coil.
 Colours: red, yellow, black.
 Tube gomme fluo souple. Echeveau de 25 mt.
 Couleurs: rouge, jaune, noir.*



Art-item	Diametro esterno Ø ext.
Art.385	mm 3
Art.386	mm 5
Art.387	mm 7
Art.388	mm 10

Art.86 TROLLER WORMS



*Lombrichi in materiale morbido biocompatibile. Ideali per la pesca alla trota e la cattura del "vivo", aguglie, occhiate, sugarelli etc.etc. Disponibili in 4 diverse colorazioni.
 Soft plastic worms ideal to catch trouts and "live baits", garfish, saddle bream, mackerel etc. etc. Biocompatible. Available in 4 different colors.
 Leurres souples à l'imitation de lombric, spécialement conçues pour la pêche à la truite et du "vif", orphie, oblade, maquereau etc. etc. Biocompatible. Disponible en 4 couleurs.*

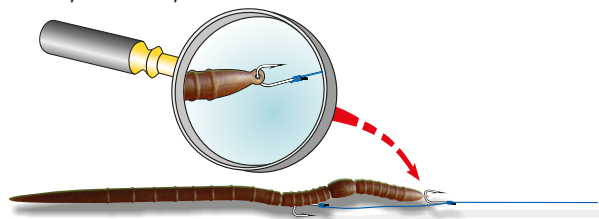
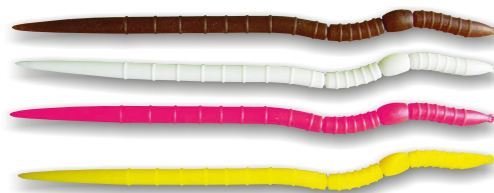

Colori - Colours - Couleurs
marrone - brown - marron
bianco - white - blanc
rosso fluo - red - rouge
giallo fluo - yellow - jaune

BUSTA DA 6 PEZZI - CONFEZIONE DA 10 BUSTE * 6 PIECES PER BAG - PACK SIZE 10 BAGS

Art.315 MATASSINA PER AGUGLIE

SKEIN LURES



*Esca artificiale ideale per la cattura delle aguglie a traina. Si usa senza amo, il rostro dell'aguglia rimane impigliato nei microfilamenti della matassina permettendone la cattura. Disponibile in 5 colori diversi.
 Trolling skein lures ideal to catch garfish without hook. Available in 5 different colours.
 Leurres pour la pêche à l'orphie à la traine sans hameçon. Disponibles en 5 couleurs.*



Colori - Colours - Couleurs
bianco - white - blanc
giallo - yellow - jaune
rosso - red - rouge
verde - green - vert
blu - blue - bleu



BUSTA DA 5 PEZZI - CONF. DA 10 BUSTE
5 PIECES PER BAG - PACK SIZE 10 BAGS

Art.588 NOSE RING 1



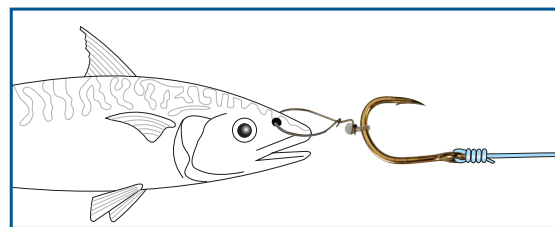

*Anelli in acciaio inox per l'innesco facile e rapido del pesce vivo tipo sugarello, sgombro, muggine, boga etc. L'anello viene introdotto nel foro nasale del pesce che rimane vitale e libero nei movimenti. L'aggancio all'amo avviene per mezzo di un piccolo elastico fornito in due diverse lunghezze.
 Stainless steel rings for easy and fast baiting of live fish as mackerel, mullet, bogue etc. The insertion of the ring in the fish nose hole allows the fish freedom of movement without damage it. The connection ring-hook is done by a small special elastic provided in two different lengths.
 Bagues en acier inox pour poisson vif comme maquereau, mullet, oblade, bogue etc. La bague vient introduite dans le trou nasal du poisson que reste vital et libre dans ses mouvements. L'accrochement à l'hameçon est par des petits élastiques spéciaux fournis en deux longueurs différentes.*



BU. DA 6 PZ. - CONF. DA 10 BU. * 6 PCS. PER BAG - PACK SIZE 10 BAGS



Art.589 **NOSE RING 2**

-  Anelli in acciaio inox per l'innesco facile e rapido del pesce vivo tipo sugarello, sgombro, muggine, boga etc. L'anello viene avvitato direttamente all'amo, bloccato definitivamente con una goccia di colla cianoacrilica e protetto con guaina termoretraibile inclusa nel prodotto.
-  Stainless steel rings for easy and fast baiting of live fish as mackerel, mullet, bogue etc. The ring has to be screwed on the hook, then fixed with a drop of cyanoacrylate glue and protected with the shrink tubing included in the bag.
-  Bagues en acier inox pour poisson vif comme maquereau, mullet, oblade, bogue etc. La bague est vissée directement sur l'hameçon, bloquée définitivement avec une goutte de colle cianoacrylate et protégée par une gaine rétractable incluse dans le sachet.

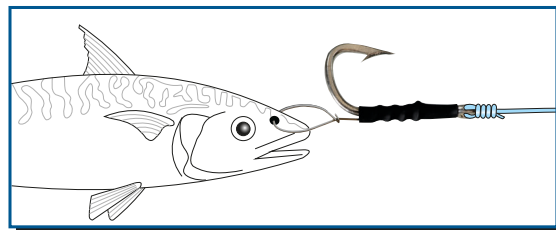
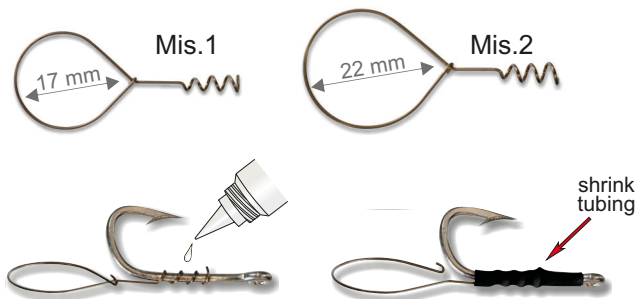
BUSTA DA 6 PEZZI - CONF. DA 10 BUSTE
6 PIECES PER BAG - PACK SIZE 10 BAGS





Art.530 **ROKNOTTER STONFO**

-  Bobinatore speciale per la realizzazione del nodo tipo PR ed impiombature "serving". Costruito in acciaio inox ergonomico e compatto munito di una precisa frizione che permette un agevole funzionamento. Il tubetto scorriello ha alla sua estremità una boccia in metallo duro resistentissima all'usura e agli urti. Munito di due bobine di diverso peso che permettono il tensionamento ideale della legatura. Ciascuna bobina ha degli anelli in gomma fermafilo che, in caso di caduta del Rotoknotter, servono ad evitare danni alla barca. Fornito completo di istruzioni per l'uso.
-  A special device suitable for making PR knots and serving. Manufactured with stainless steel, ergonomic and compact, equipped with quick adjusting disc-drag that allows a perfect running. Tube with very strong hardened steel bush to prevent fraying. Equipped with two bobbins of different weight that permit the ideal tensioning of the tying. Each bobbin has lock line rubber rings that, in case of falling of the Rotoknotter, avoid damages to the boat. Supplied with complete instructions.
-  Dispositif spécial pour la réalisation du nœud PR et ligature. Produit en acier inox, ergonomique et compact, muni de un système de frein réglable qui permet un précis fonctionnement. Tube glisse-fil avec tulipe en acier trempé très dure. Livré avec deux bobines de différent poids pour un tensionnement idéal de la ligature. Chaque bobine est munie de bagues en caoutchouc fix-ligne utiles aussi pour éviter, en cas de chute de Rotoknotter, dégâts à le bateau. Livré avec notice d'emploi.

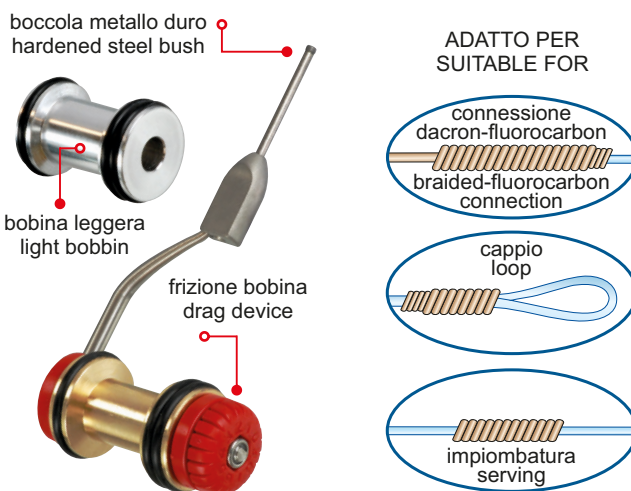
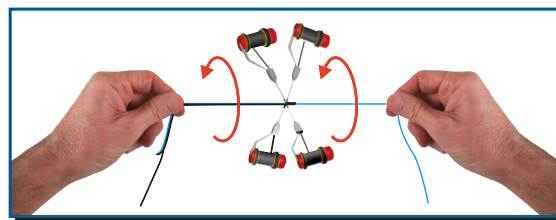
BUSTA DA 1 PEZZO - CONFEZIONE DA 5 BUSTE
1 PIECE PER BAG - PACK SIZE 5 BAGS



Art.532 **WIND-ON NEEDLES**

-  Serie completa di 7 aghi tubolari in acciaio inox più 4 aghi per asole per la realizzazione di connessioni Wind-On nei vari diametri di nylon. La connessione wind-on consiste nell'unire senza nodi due fili di diverso diametro inserendoli per un certo tratto nel trecciato tubolare tipo spectra o dacron. I cappietti alle estremità del trecciato permettono la rapida intercambiabilità del finale. Fornito completo di istruzioni per l'uso.
-  Hollow splicing needle set. Supplied complete with 7 stainless steel needles and 4 loop needles, it is suitable for making wind-on leaders in the different size of lines. This system permit the splicing without knots between mono or fluorocarbon and spectra or dacron. The interchangeability of the leader is allowed by loops on the braided spectra (loop to loop connection). Supplied with complete instructions.
-  Série complète de 7 aiguilles creux en acier inox et 4 aiguilles à boucles pour la réalisation des bas de lignes wind-on. Le système wind-on consiste dans la jonction sans nœuds entre le nylon fluorocarbène et le fil tressé type spectra ou dacron. Les boucles au bout du fil tressé permettent de changer rapidement le bas de ligne. Livré avec notice d'emploi.

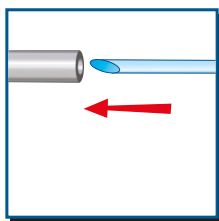

Il monofilo viene inserito dentro l'ago tubolare

Monofilament is inserted into tubular needle

Ago-needle 1	Ø ext.0,80 mm	Ø int. 0,44 mm
Ago-needle 2	Ø ext.1,00 mm	Ø int. 0,50 mm
Ago-needle 3	Ø ext.1,20 mm	Ø int. 0,75 mm
Ago-needle 4	Ø ext.1,50 mm	Ø int. 1,05 mm
Ago-needle 5	Ø ext.1,70 mm	Ø int. 1,30 mm
Ago-needle 6	Ø ext.1,90 mm	Ø int. 1,45 mm
Ago-needle 7	Ø ext.2,10 mm	Ø int. 1,60 mm
Ago Loop-needle 1	Ø ext.0,80 mm	Ø int. 0,44 mm
Ago Loop-needle 2	Ø ext.1,20 mm	Ø int. 0,75 mm

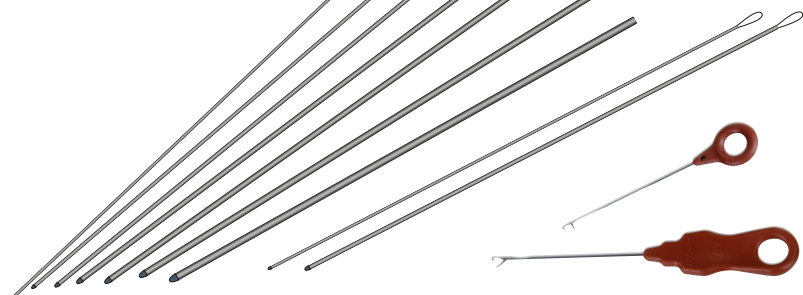

CONFEZIONE DA 1 SERIE DI WIND-ON NEEDLES
PACK SIZE 1 WIND-ON NEEDLES SET

Art.263

SGANCIO CLIP RELEASE

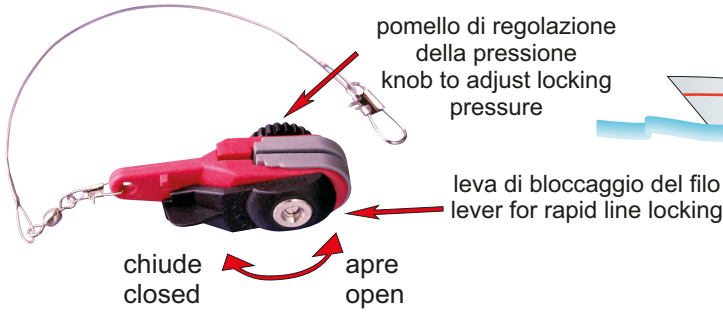

Pinza di sgancio della lenza per la pesca a traina con affondatore. Dotata di pomello di regolazione della pressione di serraggio del filo e di un esclusivo dispositivo a levetta per l'aggancio-sgancio rapido della lenza che permette di aprire o chiudere la pinza senza dover regolare nuovamente la pressione di serraggio. Brevettato.



Clip release for downrigger fishing. Equipped with knob to adjust the locking pressure of the line and with a lever device for rapid line locking. Thanks to this lever you can open or close the jaws without adjust again the locking pressure. Patented.



Pince à décrochage de la ligne pour la pêche à la traine avec treuil. La pression de serrage de la ligne est réglable grâce à un bouton très précis. Dotée d'un dispositif à levier pour accrocher ou décrocher rapidement la ligne sans régler de nouveau la pression de serrage. Breveté.

BLISTER DA 1 PEZZO - CONFEZIONE DA 10 BLISTER
1 PIECE PER BLISTER - PACK SIZE 10 BLISTERS

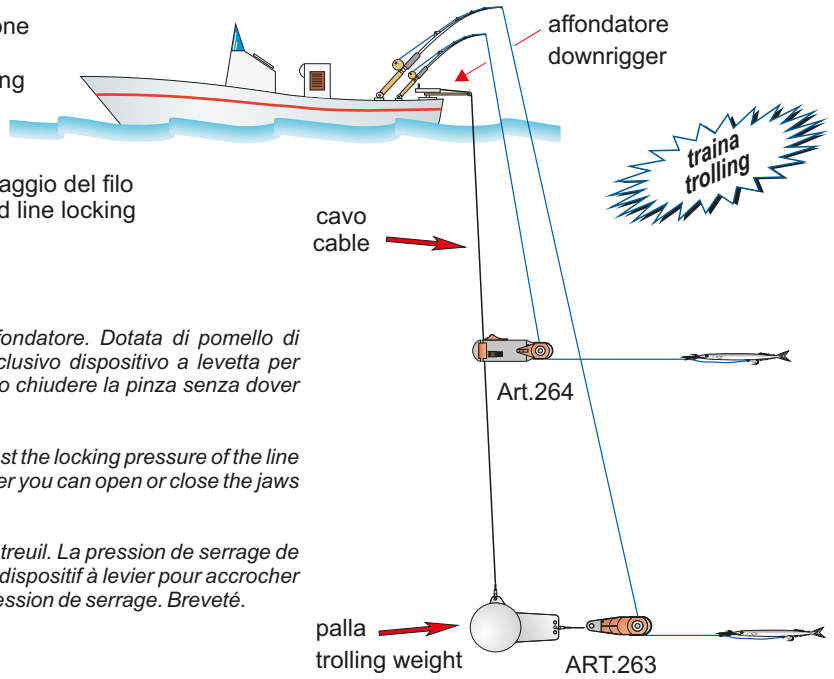

Art.264

MULTISGANCIO SPECIAL CLIP RELEASE



Pinza di sgancio della lenza per la pesca a traina con affondatore. Munita di uno speciale sistema che ne consente il bloccaggio direttamente sul cavo dell'affondatore. Dotata inoltre di pomello di regolazione della pressione di serraggio del filo e di un esclusivo dispositivo a levetta per l'aggancio-sgancio rapido della lenza che permette di aprire o chiudere la pinza senza dover regolare nuovamente la pressione di serraggio. Brevettato.



Clip release for downrigger fishing. The special rear device allows the locking on the downrigger cable. Equipped with knob to adjust the locking pressure of the line and with a lever device for rapid line locking. Thanks to this lever you can open or close the jaws without adjust again the locking pressure. Patented.



Pince à décrochage de la ligne pour la pêche à la traine avec treuil. Grâce à son système de fixation rapide elle se verrouille sur le câble du treuil. La pression de serrage de la ligne est réglable grâce à un bouton très précis. Dotée d'un dispositif à levier pour accrocher ou décrocher rapidement la ligne sans régler de nouveau la pression de serrage. Breveté.



BLISTER DA 1 PEZZO - CONFEZIONE DA 10 BLISTER
1 PIECE PER BLISTER - PACK SIZE 10 BLISTERS

Art.284

GANCIO CLIP RELEASE HOLDER



Dispositivo che permette di bloccare sul cavo dell'affondatore qualsiasi pinza di sgancio.



Clip release holder allows fast and secure locking of any clip release on the downrigger cable.



Dispositif pour la fixation rapide des pinces à décrochage sur le câble du treuil.

BLISTER DA 1 PEZZO - CONFEZIONE DA 10 BLISTER
1 PIECE PER BLISTER - PACK SIZE 10 BLISTERS

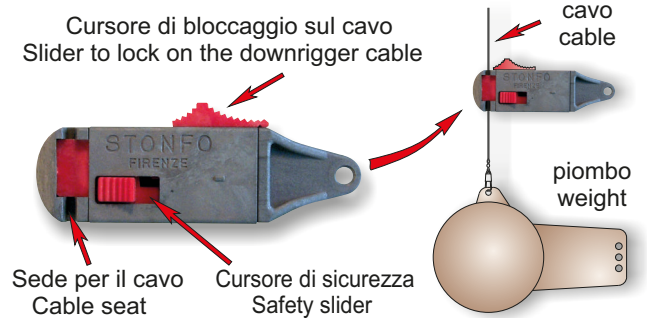

Art.50

CLIPTROLL



Dispositivo di sgancio della lenza per la traina di superficie. Mantiene il filo basso sulla superficie dell'acqua facendo "lavorare" meglio le esche. Brevettato.



Release device for surface trolling, designed to hold the fishing line near the surface. Patented.



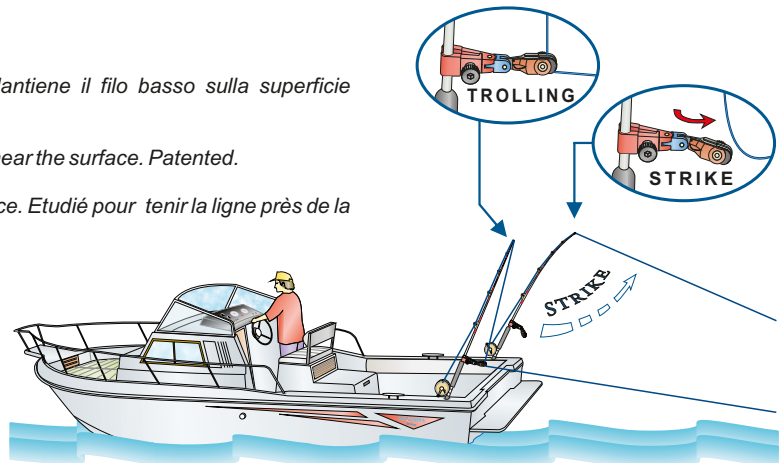
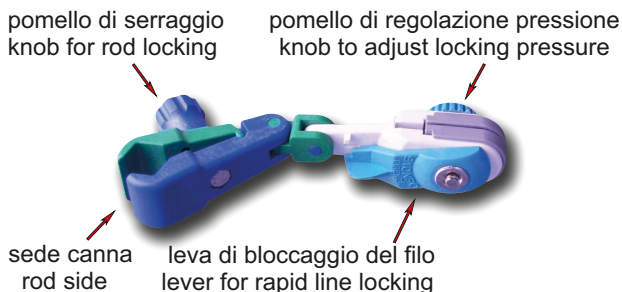

Dispositif à décrochage de la ligne pour la pêche à la traine en surface. Étudié pour tenir la ligne près de la surface de l'eau. Breveté.



BUSTA DA 1 PEZZO - CONFEZIONE DA 10 BUSTE
1 PIECE PER BAG - PACK SIZE 10 BAGS

Art.466 **OUTRIGGER CLIP**

 Pinza di sgancio della lenza per divergenti. Il pomello a vite permette una regolazione precisa della tensione di sgancio della lenza. Inoltre lo speciale sistema di bloccaggio rapido della pinza sul cavo del divergente permette al pescatore l'utilizzo di più pinze sullo stesso divergente. Brevettato.

 Release clip for fishing line with precise tension setting system. The special device for the locking on the outrigger cable allows the employment of more than one clip on the same outrigger. Patented.

 Pince déclencheur pour la pêche à la traîne avec dériveurs. La sensibilité du déclenchement de la ligne est réglable avec précision par un bouton. Grâce à son système de fixation rapide sur le câble du tangon permet l'emploi de plus pinces sur le même tangon. Breveté.

Cursore di bloccaggio sul cavo del divergente
Slider to lock the clip on the outrigger cable

Pomello di regolazione della forza di sgancio
Knob to adjust locking pressure

Sede per il cavo del divergente
Outrigger cable seat

Cursore di sicurezza
Safety slider

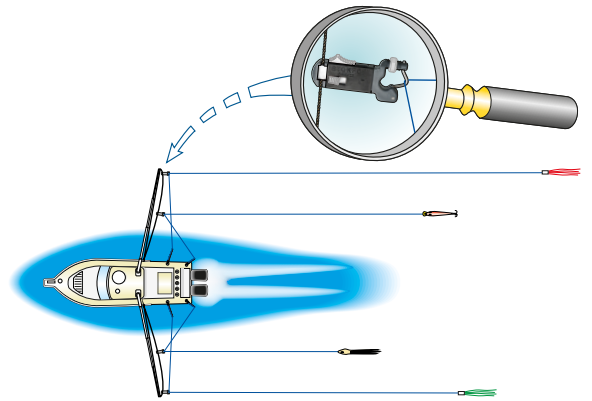
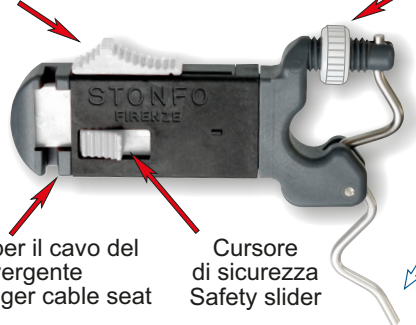

BLISTER DA 1 PEZZO - CONFEZIONE DA 10 BLISTER
1 PIECE PER BLISTER - PACK SIZE 10 BLISTERS

Art.266 **GOMME DI RICAMBIO PINZE TRAINA** SPARE GRIPPER PADS FOR CLIP RELEASE

 Gommine di ricambio per Sgancio (art.263), Multisgancio (art.264), Cliproll (art.50).

 Spare gripper pads for Clip Release (item 263), Special Clip Release (item 264), Cliproll (item 50).

 Caoutchouc de rechange pour Sgancio (art.263), Multisgancio (art.264), Cliproll (art.50).

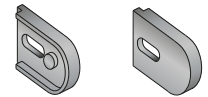

BUSTA DA 4 PEZZI - CONFEZIONE DA 10 BUSTE
4 PIECES PER BAG - PACK SIZE 10 BAGS

Art.685 **PRO-DIVER1** GR 60 CM10

 Affondatore idrodinamico con alettone mobile per la regolazione della profondità. Ideale per la traina ultra-leggera. Velocità di traina da 1 a 7 nodi. In caso di abboccata torna in superficie rendendo agevole la cattura del pesce.

 Hydrodynamic diver with mobile spoiler for depth adjustment. Ideal for ultra-light trolling. Trolling speed from 1 to 7 knots. In case of bite returns to the surface making easy the catch of the fish.

 Plongeur hydrodynamique avec aileron mobile pour le réglage de la profondeur. Idéal pour la traîne ultra-légère. Vitesse de traîne de 1 à 7 nœuds. En cas de touche il revient à la surface en rendant facile la capture de poisson.

BLISTER DA 1 PEZZO - CONFEZIONE DA 5 PEZZI
1 PIECE BLISTER PACK - PACK SIZE 5 PIECES

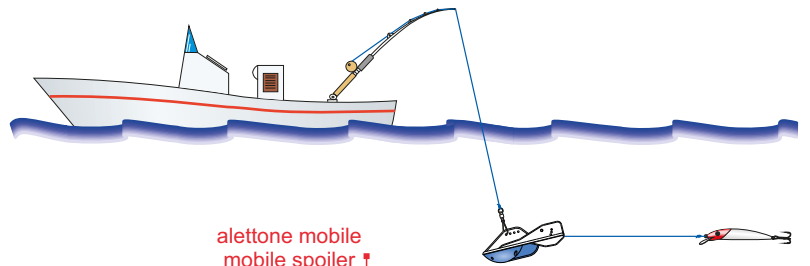



alettone mobile
mobile spoiler
aileron mobile



Art.686 **PRO-DIVER2** GR 160 CM14

 Affondatore idrodinamico con alettone mobile per la regolazione della profondità. Ideale per la traina leggera. Velocità di traina da 1 a 7 nodi. In caso di abboccata torna in superficie rendendo agevole la cattura del pesce.

 Hydrodynamic diver with mobile spoiler for depth adjustment. Ideal for light trolling. Trolling speed from 1 to 7 knots. In case of bite returns to the surface making easy the catch of the fish.

 Plongeur hydrodynamique avec aileron mobile pour le réglage de la profondeur. Idéal pour la traîne légère. Vitesse de traîne de 1 à 7 nœuds. En cas de touche il revient à la surface en rendant facile la capture de poisson.

BLISTER DA 1 PEZZO - CONFEZIONE DA 5 PEZZI
1 PIECE BLISTER PACK - PACK SIZE 5 PIECES





CINTURE BOLENTINO LIGHT COMBAT BELTS - BAUDRIERS LÉGERS

Art.127 CON PERNO in acciaio inox - WITH PIVOT in stainless steel

Art.128 Con bicchierino basculante - Rotating gimbal model

 Cinture da combattimento leggere e molto confortevoli studiate per la pesca a bolentino. Prodotte con materiale plastico resistentissimo accoppiato ad una imbottitura morbida di 10 mm di spessore. Munite di chiusura con fibbia a scatto. Art 127 modello con perno in acciaio inox. Art.128 modello con bicchierino basculante.

 Small and comfortable combat-belts, ideal for boat fishing and light trolling. Made of undestroyable plastic material coupled with a soft padding. Equipped with snap lock buckle. Item nr.127 with stainless steel pivot. Item nr.128 with rotating gimbal.

 Baudriers très légers et très confortables, étudiés pour la petite traîne et la pêche a soutenir. Fabriqués en plastique incassable avec rembourrage mousse et ceinture à attache rapide ajustable. L'Art.127 est muni d'un pivot en inox. L'Art.128 est muni d'un godet-cardan qui permet une meilleure maniabilité de la canne.

CONFEZIONE DA 1 PEZZO
PACK SIZE 1 PIECE

CINTURE TRAINA

COMBAT BELTS - BAUDRIERS

Art.129 CON PERNO in acciaio inox - WITH PIVOT in stainless steel

Art.130 Con bicchierino basculante - Rotating gimbal model

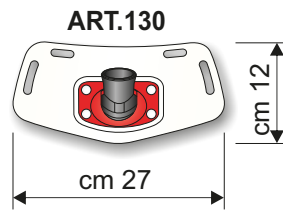
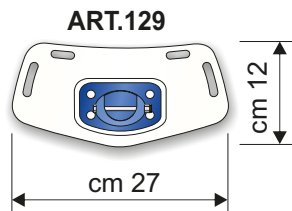

 Cinture da combattimento comode e pratiche, prodotte con materiale plastico resistentissimo accoppiato ad una imbottitura morbida di 10 mm di spessore. Munite di chiusura con fibbia a scatto. Art 129 modello con perno in acciaio inox. Art.130 modello con bicchierino basculante.

 Useful and comfortable combat-belts, made of undestroyable plastic material coupled with a soft padding. Equipped with snap lock buckle. Item nr.129 with stainless steel pivot. Item nr.130 with rotating gimbal.

 Baudriers pratiques et très confortables, fabriqués en plastique incassable avec rembourrage mousse et ceinture à attache rapide ajustable. L'Art.129 est muni d'un pivot en inox. L'Art.130 est muni d'un godet-cardan qui permet une meilleure maniabilité de la canne.

CONFEZIONE DA 1 PEZZO
PACK SIZE 1 PIECE

Art.70 **BRETELLE PER CINTURE**

COMBAT BELT BRACES
BRETELLES POUR BAUDRIERS

 Bretelle per cinture da combattimento con moschettoni in metallo. L'applicazione alla cintura avviene grazie a due ganci rapidi universali.

 Combat belt braces with metal snaps and universal fast connectors.

 Bretelles équipées des mousquetons en métal et attaches rapides.



CONFEZIONE DA 1 PEZZO
PACK SIZE 1 PIECE



- Art.104 CON PERNO in acciaio inox - PIVOT MODEL
- Art.105 CON BICCHIERINO - GIMBAL MODEL

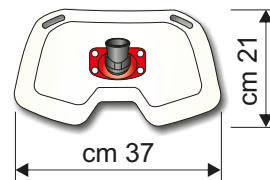

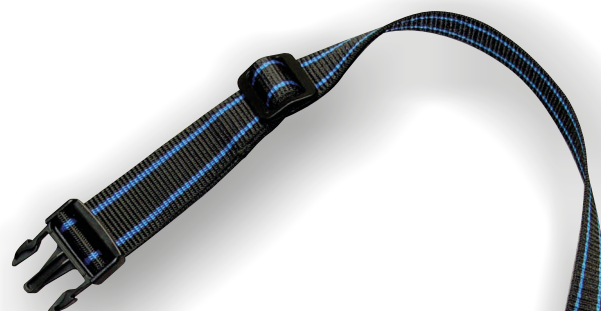

ART.104



ART.105

 Cinture da combattimento studiate per la pesca di grosse prede in stand-up, prodotte con materiale plastico resistentissimo accoppiato ad una imbottitura morbida di 15 mm di spessore. Munite di chiusura con fibbia a scatto.

 Useful and comfortable stand-up combat belts for big fishes, made of undestroyable plastic material coupled with a 15 mm soft padding. Equipped with snap lock buckle.

 Baudriers idéals pour la pêche des grands poissons en stand-up, fabriqués en plastique incassable avec rembourrage mousse de 15 mm d'épaisseur pour un confort absolu. Munis d'une ceinture à attache rapide ajustable.

CONFEZIONE DA 1 PEZZO * PACK SIZE 1 PIECE

Art.549 OLIO LUBRIFICANTE
LUBRICANT OIL - GRAISSE DE SILICONE

 Olio speciale lubrificante idrorepellente. Ideale per mulinelli, anelli per canne etc. etc.

 Special water-repellent lubricant oil. Ideal to lubricate reels, rod guides, etc...

 Huile spéciale lubrifiante hydrofuge. Idéale pour moulinets, anneaux des cannes etc.etc.

BUSTA DA 1 PEZZO - CONFEZIONE DA 10 BUSTE
1 PIECE PER BAG - PACK SIZE 10 BAGS

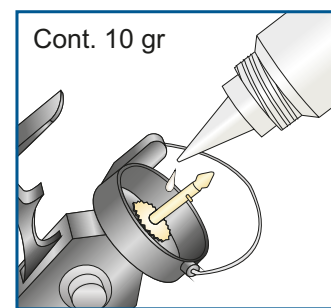

Cont. 10 gr

Art.554 REEL LUBE GREASE

 Grasso al silicone ideale per lubrificare e proteggere le parti in metallo dalla corrosione.

 Silicone grease ideal to lubricate and protect metal parts from corrosion.

 Graisse silicone idéal pour lubrifier et protéger les parties en métal de la corrosion.

BUSTA DA 1 PEZZO - CONFEZIONE DA 10 BUSTE
1 PIECE PER BAG - PACK SIZE 10 BAGS

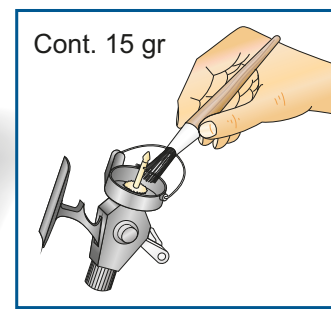

Cont. 15 gr

COMMAND GRIP PINZE SALPA PESCI - FISH LIP GRABBER - PINCES À POISSON



Pinze salpa pesci indispensabili per chi pratica il catch and release in quanto aiutano durante l'operazione di slamatura. Le caratteristiche speciali di queste pinze permettono di afferrare saldamente il pesce per la bocca senza arrecargli danno. Le loro ganasce sono perfettamente arrotondate, ricoperte in gomma ed hanno un'ampia superficie di contatto. La forza di chiusura della pinza viene controllata dal pescatore ed è indipendente dal peso del pesce. Leggerissime, compatte ma estremamente robuste queste pinze lavorano bene sia con pesci di piccola che di grossa taglia. Dotate di impugnatura ergonomica in gomma antiscivolo e di laccetto regolabile sono adatte sia per la pesca in acqua dolce che in mare. Per non ferire il pesce si consiglia comunque di sostenerne il peso con l'altra mano o se possibile di lasciare il pesce in acqua ed utilizzare la pinza come ausilio alla slamatura.



Fish lip grabbers, indispensable for the catch and release. The special features of these pliers allow you to grab the fish by the mouth without injuring it. The jaws are rubber coated and the rounded tips have a large contact surface, furthermore the closing force of the pliers can be adjusted by the angler. Ultra lightweight, compact with high strength body, these pliers are suitable for small and big size fishes. Perfect for both fresh and saltwater use. Their anatomic handle is in antiskid rubber. Supplied with adjustable wrist strap. To avoid harm to fish, we recommend to support its body with the other hand or if possible leave the fish in the water and only use the pliers to hold it while taking off the hook.



Pinces à poisson indispensables pour le catch and release. Les caractéristiques particulières de ces pinces permettent de saisir fermement le poisson par la bouche sans l'abîmer grâce à leur mâchoires avec une grande surface de contact et les bouts arrondis plus mous en caoutchouc. En plus, la pression de serrage est réglable par le pêcheur. Très légères et compactes mais extrêmement solides elles sont également adaptées pour poissons de petite et grande taille en mer comme en eaux douces. Munies de poignée en caoutchouc anti-glisse et d'un cordon réglable. Pour éviter de blesser le poisson nous conseillons de soutenir son corps avec l'autre main ou si possible laisser le poisson dans l'eau et utiliser la pince uniquement pour le temps d'ôter l'hameçon.

Art.617

COMMAND GRIP 1 ROCK FISHING MODEL

Dimensioni contenute cm 14
Small sized cm 14
Compacte cm 14

Leggerissima gr 70
Ultra light gr 70
Ultra légère gr 70

Comando di apertura
Button opening
Commande d'ouverture



Art.618

COMMAND GRIP 2

Dimensioni contenute cm 21
Small sized cm 21
Compacte cm 21

Leggerissima gr 150
Ultra light gr 150
Ultra légère gr 150

Ganasce in gomma salva-pesci
Fish saver rubber jaws
Mâchoires en caoutchouc
protège poisson

Tecnopolimero ultra resistente antiruggine
Techno-polymer corrosion free
Techno-polymère très résistant antirouille

Forza di chiusura regolabile
Adjustable closing force
Pression de serrage réglable

Impugnatura anatomica in gomma
Anatomic rubber handle
Poignée anatomique en caoutchouc

CONFEZIONE DA 1 PEZZO - PACK SIZE 1PIECE



Art.537

PESCIOMETRO TAPE MEASURE FISH - MÈTRE MESURE POISSONS



Nastro impermeabile centimetrato misura-pesci. Sul nastro ci sono raffigurati molti pesci accanto ai quali è possibile annotare la misura minima ammessa. La confezione contiene inoltre adesivo con tabella misure minime per l'Italia. Lunghezza del nastro cm 60.



Waterproof measuring tape to measure fish you catch. On the tape there are many pictures of the fishes where it is possible to write the legal length. Tape length cm 60.



Mètre à ruban imperméable mesure-poissons. Muni de plusieurs dessins des poissons ou à côté de chaque on peut écrire les tailles légales minimales. Longueur du ruban cm 60.

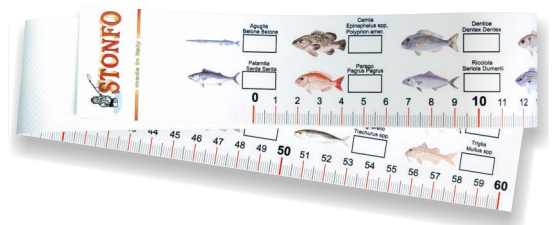

BUSTA DA 1 PZ. - CONF. DA 10 BUSTE
1 PIECE PER BAG - PACK SIZE 10 BAGS





WWW.STONFO.COM

 [stonfo_fishing_tackle](https://www.instagram.com/stonfo_fishing_tackle)

 [@stonfofishingtackle](https://www.tiktok.com/@stonfofishingtackle)