

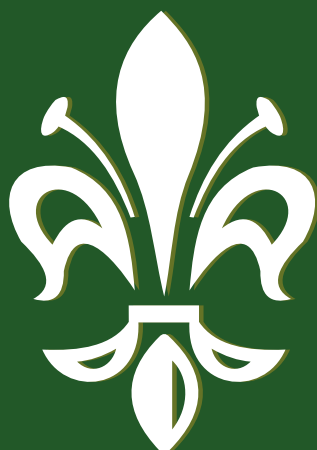

CATALOGO 2026 FLY FISHING

FISHING TACKLE FACTORY
MADE IN ITALY



STOPPIONI s.n.c. Firenze ITALY
Phone 00390558739615 Prod.Effevuemme s.r.l.
E-mail: stonfo@stonfo.com Web site: www.stonfo.com

PRODUTTORE





MANUFACTURER



FABRICANT



 Specializzata nella produzione di articoli per ogni tipo di pesca sportiva, la Ditta Stoppioni s.n.c. opera con il suo marchio Stonfo da oltre 45 anni a livello internazionale. I prodotti Stonfo sono conosciuti ed apprezzati dai pescatori per l'alta qualità dei materiali impiegati, per l'eccellente finitura e per le soluzioni innovative che molti di essi presentano. Tutti gli articoli sono prodotti all'interno dell'azienda, dalla progettazione alla produzione fino al confezionamento finale, impiegando attrezzature particolari, macchinari sofisticati con personale altamente qualificato. La Stoppioni s.n.c. è in grado, grazie alla sua organizzazione produttiva e ad un magazzino sempre rifornito, di soddisfare le richieste dei propri clienti in tempi rapidissimi in ogni parte del mondo.

 Based in Florence, Italy, from over 45 years Stoppioni s.n.c. is specialised in the production of accessories for every type of fishing. These products are marketed under the Stonfo label through large wholesalers on a world-wide basis. Many items are patented and the company will soon be introducing others to the market as it continues to research and develop new ideas. Stonfo works with a variety of different materials in its manufacturing process and all products are entirely developed inside the company from the initial idea to the making and marketing. The company use a number of distributors so that orders to all parts of the world can be dispatched.

 Installée à Florence depuis plus de 45 ans, la Société Stoppioni est spécialisée dans la production d'accessoires pour la pêche. Tous ses produits portent la marque Stonfo, la plupart sont brevetés et chaque année ils s'enrichissent de nombreuses nouveautés. Stonfo travaille sur de nombreux matériaux et maîtrise entièrement toutes les étapes de fabrication. Stonfo utilise de nombreux distributeurs qui permettent de livrer tous les clients le plus rapidement possible partout dans le monde.



1978 Mr.Ivo Stoppioni Mr.Franco Pieri

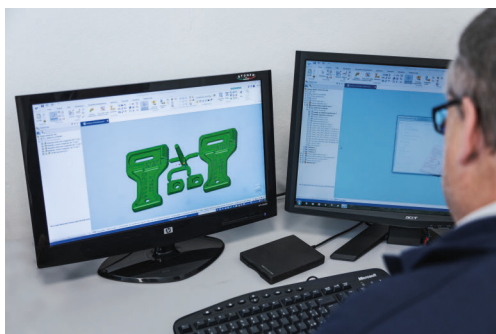

**TANTE NUOVE IDEE
A LOT OF NEW IDEAS**

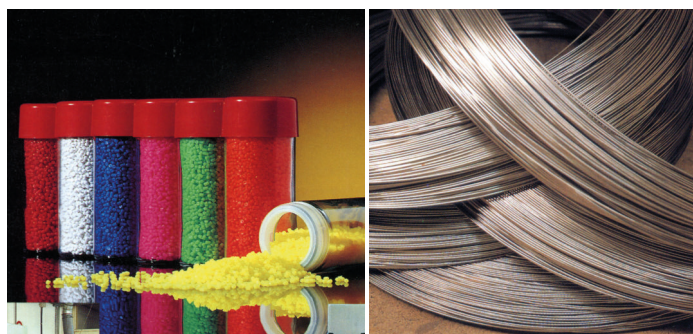

**LE MIGLIORI MATERIE PRIME
THE BEST RAW MATERIALS**



**MACCHINE AD ALTA TECNOLOGIA
HIGH TECH MACHINERY**



**PERSONALE QUALIFICATO
SKILLED WORKERS**

INDICE PER CODICE - CODE INDEX

Art 97: Scatoline componibili (200 x bag).....	pag 35
Art 186: Segnafilo (Line signal).....	pag 24
Art 231: Baby magnete (Baby magnetic box).....	pag 35
Art 233S: Magnetico box.....	pag 35
Art 234S: Fly bait box.....	pag 34
Art 243S: Fly box magnum.....	pag 34
Art 248S: Super magnete (Super magnetic box).....	pag 35
Art 259S: Doppio magnete (Double magnetic box).....	pag 35
Art 267S: Orange magnetic.....	pag 35
Art 270S→271S: Light magnetic boxes.....	pag 35
Art 378: Segnafilo intercambiabile(Interchangeable line signal).....	pag 24
Art 427: Cast connectors.....	pag 25
Art 435: No nodo.....	pag 26
Art 438: Bobinatore (Bobbin).....	pag 10
Art 439: Rotodubbing 1.....	pag 11
Art 440: Rotodubbing 2.....	pag 11
Art 441: Set annodatore conico (Conical finisher).....	pag 10
Art 442: Annodatore (Finisher).....	pag 10
Art 443: Dubbing 1.....	pag 11
Art 444: Dubbing 2.....	pag 11
Art 445: Spillo di montaggio (Bodkin).....	pag 10
Art 446: Passafilo 1 (Bobbin threader type 1).....	pag 9
Art 447: Passafilo 2 (Bobbin threader type 2).....	pag 10
Art 457: Bobinatore maxi (Maxi bobbin).....	pag 10
Art 462: Pinze per hackles (Hackle pliers).....	pag 10
Art 463: Dry fly gel.....	pag 33
Art 464: Fly line grease.....	pag 33
Art 469: Dubbing twister.....	pag 11
Art 470: Pareggiapelo (Hair stacker).....	pag 11
Art 471: Scatoline componibili (Modular boxes).....	pag 35
Art 475→476: Morsetti flylab (Flylab vises).....	pag 1
Art 477→478: Morsetti flytec (Flytec vises).....	pag 1
Art 479: Pinza morsetto (Vise jaws).....	pag 5
Art 480: Supporto bobinatore (Bobbin rest).....	pag 7
Art 481: Supporto parachute (Parachute attachment).....	pag 7
Art 482: Pinzetta parachute (Parachute plier).....	pag 7
Art 483: Spirale di bloccaggio (Spring material clip).....	pag 7
Art 484: Base tavolo (Pedestal base).....	pag 6
Art 486→487: Bilancine (Scales).....	pag 31
Art 488: Tube fly tool.....	pag 18
Art 494: Testina clessidra (Hourglass heads).....	pag 19
Art 495→496: Testina conica (Coneheads).....	pag 18
Art 497: Tubetto conico metallo (Conic metal tube).....	pag 18
Art 498: Prolunga tubetto (Tube extension).....	pag 18
Art 499: Tubetto plastica rigido (Clear plastic tube).....	pag 18
Art 500: Testina cono piatto (Flat coneheads).....	pag 18
Art 501: C clamp.....	pag 6
Art 502: Spillo di servizio (Double taper needle).....	pag 28
Art 503: Pinza hackles standard (Standard hackles plier).....	pag 10
Art 504: Morsetto flylab leva (Flylab lever vise).....	pag 1
Art 511→512: Holo lure eyes.....	pag 21
Art 513: 3D fishscale adhesive tape.....	pag 21
Art 514: Light boxes.....	pag 35
Art 516: Morsetto flytec leva (Flytec lever vise).....	pag 2
Art 518: Colla cianox (Cianox glue).....	pag 19
Art 520: Botton service magnetico.....	pag 29
Art 523: Joint rings.....	pag 25
Art 524: Realistic eggs.....	pag 22
Art 525: Botton service.....	pag 28
Art 526: Botton service doppio.....	pag 28
Art 527: Fly patch.....	pag 28
Art 528: Bobinatore elite (Elite bobbin).....	pag 13
Art 531: Nylon dispenser.....	pag 29
Art 533: Safety cord.....	pag 28
Art 536: Scatole F type (F type boxes).....	pag 35
Art 537: Pesciometro (Measuring tape).....	pag 32
Art 538→539: Fluo lure eyes.....	pag 21
Art 540: Livrea fluo adhesive tape.....	pag 21
Art 542: Schermo per morsetto (Profile plate for vise).....	pag 8
Art 544: Imbobinatore (Spooling station).....	pag 34
Art 545→546: Attractor beads.....	pag 22
Art 547: Super float fly oil.....	pag 33
Art 548: Tiranodo (Tighten knot).....	pag 33
Art 549: Olio lubrificante (Lubricant oil).....	pag 33
Art 551: Tippet holder.....	new 2
Art 553: Dry fly spheres.....	pag 34
Art 554: Reel lube grease.....	pag 34
Art 575: Tinsel.....	pag 20
Art 576: Minibox nimph.....	pag 34
Art 577: Pinze hackles elite (Elite hackle pliers).....	pag 13
Art 578: Bobinatore elite 2 (Elite bobbin 2).....	pag 13
Art 579: Bobinatore elite compact (Elite bobbin compact).....	pag 13
Art 584: Coprinodo (Knot cover).....	pag 25
Art 586: Annodatore elite (Elite finisher).....	pag 14
Art 590: Spillo elite (Elite bodkin).....	pag 15
Art 591: Annodatore conico elite (Elite conical finisher).....	pag 15
Art 594: Fil tec.....	pag 23
Art 597→598: Plastic eyes.....	pag 22

Art 599: Jungle cock fantasy.....	pag 24
Art 600: Synthetic wings.....	pag 24
Art 601: Synthetic film.....	pag 21
Art 603: Collana stonfo (Fishing neck lanyard).....	pag 33
Art 605: Fly patch elite.....	pag 28
Art 609: Morsetto kaiman (Kaiman vise).....	pag 2
Art 610: Morsetto tubefly (Tubefly vise).....	pag 2
Art 611: Stendifinali (Leader straightener).....	pag 29
Art 612: Rotodubbing elite.....	pag 15
Art 613: Supporto elite (Elite support).....	pag 6
Art 614: Vaschetta raccogli sporco (Waste bin).....	pag 8
Art 615: Slamatori tubetech (Tubetech disgorgers).....	pag 31
Art 616: Pulisci & ingrassa coda (Fly line cleaner).....	pag 29
Art 617→618: Command grip.....	pag 32
Art 619: Palette mini (Mini lure lips).....	pag 22
Art 622: Botton service mini.....	pag 29
Art 623: Dropper clips.....	pag 26
Art 624: Reel line clip.....	pag 27
Art 625: Foam strike indicators.....	pag 24
Art 626: Joint block.....	pag 7
Art 630: Lente per morsetto (Magnifying glass).....	pag 9
Art 631: Magnetic rod holder.....	pag 33
Art 633: Anti-alga (Weed guard).....	pag 23
Art 634: Pinze per dubbing (Hair clips).....	pag 17
Art 635: Thread splitter.....	pag 17
Art 636: Quicklink rounded shape.....	pag 26
Art 637: Wirelink clip.....	pag 27
Art 638: Quicklink elliptical shape.....	pag 26
Art 639: Passafilo elite (Elite threader).....	pag 15
Art 642: Lente a ventosa (Magnifying glass suction cup base).....	pag 9
Art 645: Pettine comb.....	pag 12
Art 646: Tubular light shank.....	pag 23
Art 647: Tubular strong shank.....	pag 23
Art 648: Creative dubbing kit.....	pag 17
Art 649: Polymultifil.....	pag 20
Art 650: DB tools.....	pag 18
Art 651: Hair packer.....	pag 12
Art 652: Needles set.....	pag 26
Art 653: Morsetto elite (Elite vise).....	pag 3
Art 654: Morsetto transformer (Transformer vise).....	pag 4
Art 655: Pinza stonfo1 (Stonfo1 jaw).....	pag 5
Art 656: Pinza stonfo2 (Stonfo2 jaw).....	pag 5
Art 657: Base TRR (TRR pedestal base).....	pag 6
Art 658: Synt oval tape.....	pag 20
Art 659: Synt flat tape.....	pag 20
Art 660: Super jaw disgorgere.....	pag 31
Art 661: Dubbing brush device.....	pag 8
Art 665: Slama releaser.....	pag 30
Art 667→668: Streamer fish heads.....	pag 19
Art 671: Tapered pins.....	pag 18
Art 674→675: Bobtec1-2.....	pag 13-14
Art 678: Hair compactor.....	pag 17
Art 679: Stonfo rod holder.....	pag 27
Art 684: Turbo spin.....	pag 8
Art 689: Streamer soft heads (mis 1-2).....	pag 19
Art 692: Tool bar.....	pag 7
Art 693: Spillo curvo elite (Bended bodkin).....	pag 15
Art 695: Pareggiapelo mini (Mini hair stacker).....	pag 12
Art 696: Coccodrillo.....	pag 12
Art 699: Morsetto airone (Airone vise).....	pag 5
Art 700: Streamer soft heads (mis 3-4-5).....	pag 19
Art 701: Lure snaps.....	pag 27
Art 704: Rotodubbing mini.....	pag 11
Art 705: Stripping basket.....	pag 30
Art 706: Coprinodo maxi (Knot cover maxi).....	pag 25
Art 707: Razor stonfo.....	pag 14
Art 708: Nipper stonfo.....	pag 12
Art 709: Razor blades.....	pag 14
Art 711: Travel tool set.....	pag 9
Art 723: Cdc feathers block.....	pag 16
Art 725: Thread cutter.....	pag 16
Art 726: Cdc winding tool.....	pag 16
Art 727: Trimmer.....	pag 16
Art 730: Lure line holder.....	pag 30
Art 732: Box 260x190x26 sc. 1.....	new 3
Art 740: Magnetic material clip.....	new 5
Art 741: Stonfo fly tying kit.....	new 4
Art 742: Box 260x190x26 sc.6.....	new 3
Art 743: Box 260x190x26 sc. 12.....	new 3
Art 744: Steeltech bobbin.....	new 4
Art 745: Streamer bobbin.....	new 5
Art 746: Angle joint.....	new 5
Art 750: Hackle Gauge.....	new 3
Art 759: Micro Plier.....	new 3
Art 762: Spool bands.....	new 2
Art 763: Tool station.....	new 1
Art 764: Dubbing loop kit.....	new 2

NEW

NEW

NEW

NEW

INDICE ALFABETICO - ALPHABET. INDEX

Angle joint.....	new 5
Annodatori (Finishers).....	pag 10-14-15
Anti-alga (Weed guard).....	pag 23
Attractor beads.....	pag 22
Baby magnete (Baby magnetic box).....	pag 35
Basi per morsetto (Pedestal base).....	pag 6
Bilancine (Scales).....	pag 31
Bobinatori (Bobbins).....	pag 10-13
Bobtec.....	pag 13-14
Botton service.....	pag 28-29
Box 260x190x26.....	new 3
C clamp.....	pag 6
Cast connector.....	pag 25
Cdc feathers block.....	pag 16
Cdc winding tool.....	pag 16
Coccodrillo.....	pag 12
Colla cianox (Cianox glue).....	pag 19
Collana stonfo (Fishing neck lanyard).....	pag 33
Command grip.....	pag 32
Coprinodo (Knot cover).....	pag 25
Creative dubbing kit.....	pag 17
DB tools.....	pag 18
Doppio magnete (Double magnetic box).....	pag 35
Dropper clips.....	pag 26
Dry fly gel.....	pag 33
Dry fly spheres.....	pag 34
Dubbing.....	pag 11
Dubbing brush device.....	pag 8
NEW Dubbing loop kit.....	new 2
Fil tec.....	pag 23
Fluo lure eyes.....	pag 21
Fly bait box.....	pag 34
Fly boxes.....	pag 34
Fly line grease.....	pag 33
Fly patch.....	pag 28
Foam strike indicator.....	pag 24
Hackle gauge.....	new 3
Hair compactor.....	pag 17
Hair packer.....	pag 12
Holo lure eyes.....	pag 21
Imbobinatore (Spooling station).....	pag 34
Joint block.....	pag 7
Joint rings.....	pag 25
Jungle cock fantasy.....	pag 24
Lenti d'ingrandimento (Magnifying glasses).....	pag 9
Light boxes.....	pag 35
Livrea fluo adhesive tape.....	pag 21
Lure line holder.....	pag 30
Lure snaps.....	pag 27
Magnetic box.....	pag 35
Magnetic rod holder.....	pag 33
Magnetic material clip.....	new 5
Micro plier.....	new 3
Minibox nymph.....	pag 34
Morsetti pesca a mosca (Fly fishing vises).....	1-2-3-4-5
Needles set.....	pag 26
Nipper stonfo.....	pag 12
No nodo.....	pag 26
Nylon dispenser.....	pag 29
Olio lubrificante (Lubricant oil).....	pag 34
Orange magnetic.....	pag 35
Palette mini (Mini lure lips).....	pag 22
Pareggiapelo (Hair stacker).....	pag 11-12
Passafilo (Bobbin threader).....	pag 9-10-15
Pesciometro (Measuring tape).....	pag 32
Pettine comb.....	pag 12
Pinze morsetto (Vise jaws).....	pag 5

Pinze per dubbing (Hair clips).....	pag 17
Pinze per hackles (Hackle pliers).....	pag 10-13
Pinzetta parachute (Parachute plier).....	pag 7
Plastic eyes.....	pag 22
Polymultifil.....	pag 20
Prolunga per tubetto (Tube extension).....	pag 18
Pulisci & ingrassa coda (Fly line cleaner).....	pag 29
Quicklink elliptical shape.....	pag 26
Quicklink rounded shape.....	pag 26
Razor.....	pag 14
Realistic eggs.....	pag 22
Reel line clip.....	pag 27
Reel lube grease.....	pag 34
Rotodubbing.....	pag 11-15

Safety cord.....	pag 28
Scatole F type (F type boxes).....	pag 35
Scatoline componibili (Modular boxes).....	pag 35
Scatoline porta ami (Micro size slide box).....	pag 35
Schermo per morsetto (Profile plate for vise).....	pag 8
Segnafilo (Line signal).....	pag 24
Set annodatore conico (Conical finisher).....	pag 10
Slama releaser.....	pag 30
Slamatori tubetech (Tubetech disgorgers).....	pag 31
Spilli di montaggio (Bodkins).....	pag 10-15
Spillo di servizio (Double taper needle).....	pag 28
Spirale di bloccaggio (Spring material clip).....	pag 7
NEW Spool bands.....	new 2
Steeltech bobbin.....	new 4
Stendifinali (Leader straightener).....	pag 29
Stonfo fly tying kit.....	new 4
Stonfo rod holder.....	pag 27
Streamer bobbin.....	new 5
Streamer heads.....	pag 19
Stripping basket.....	pag 30
Super float fly oil.....	pag 33
Super jaw disgorger.....	pag 31
Super magnete (Super magnetic box).....	pag 35
Supporti parachute e bobinatore (Parach. & bobbin rests).....	pag 6-7
Synt tape.....	pag 20
Synthetic film.....	pag 21
Synthetic wings.....	pag 24

Tapered pins.....	pag 18
Testina clessidra (Hourglass heads).....	pag 19
Testine coniche (Coneheads).....	pag 18
Thread cutter.....	pag 16
Thread splitter.....	pag 17
Tinsel.....	pag 20
NEW Tippet holder.....	new 2
Tiranodo (Tighten knot).....	pag 33
Tool bar.....	pag 7
NEW Tool station.....	new 1
Travel tool set.....	pag 9
Trimmer.....	pag 16
Tube fly tool.....	pag 18
Tubetti per tube fly (Tubes for tube fly).....	pag 18
Tubular shanks.....	pag 23
Turbo spin.....	pag 8

Vaschetta raccogli sporco (Waste bin).....	pag 8
--	-------

Wirelink clip.....	pag 27
--------------------	--------

3D fishscale adhesive tape.....	pag 21
---------------------------------	--------



NEW PRODUCTS 2026 FLY FISHING

Art.763 TOOL STATION



Porta utensili con molteplici alloggiamenti, tasche e fori per tenere in modo ordinato ed a portata di mano tutto ciò che occorre per il costruttore di mosche. In totale il Tool Station ha 13 alloggiamenti per bobinatori, 12 aste per riporre 32 bobine di filo, 23 fori per il posizionamento di utensili vari, 6 alloggiamenti per forbici e taglierini, 5 alloggiamenti per boccettine di colla vernice etc, 7 tasche rettangolari di varie dimensioni per contenere accessori vari, 3 tasche con fondo magnetico per riporre mosche ed ami, 1 asta porta pinze per dubbing, 2 fori per il fissaggio della lente d'ingrandimento. Prodotto in materiale molto resistente. Munito di quattro piedini in gomma antiscivolo. Dim.cm 29,7x20,8x7,3.



Tool station with various slots, pockets, and holes to keep organized and within reach everything a fly tyer needs. The Tool Station has 13 slots for bobbin holders, 12 shafts to hold 32 thread spools, 23 holes for various tools, 6 slots for scissors and cutters, 5 round pockets for storing glue, paint, etc., 7 rectangular pockets of various sizes for various accessories, 3 pockets with magnetic bottom for arranging flies and hooks, 1 shaft for hair clips, and 2 slots for attaching the magnifying glass. Made of highly durable material, it's equipped with four skidproof rubber feet. Dim.: 29.7 x 20.8 x 7.3 cm.



Station d'outils avec divers compartiments, poches et trous pour ranger et avoir à portée de main tout le matériel nécessaire au montage de mouches. Cette station comprend 13 emplacements pour porte bobines, 12 antennes pour 32 bobines de fil, 23 trous pour divers outils, 6 emplacements pour ciseaux et cutters, 5 compartiments ronds pour ranger colle, peinture, etc., 7 poches rectangulaires de différentes tailles pour divers accessoires, 3 compartiments à fond magnétique pour ranger mouches et hameçons, 1 antenne pour pinces à dubbing et 2 emplacements pour fixer la loupe.

Fabriquée avec un matériau très résistant, elle est équipée de quatre pieds en caoutchouc antidérapants. Dimensions : 29,7 x 20,8 x 7,3 cm.

CONFEZIONE DA 1 PEZZO - PACK SIZE 1 PIECE

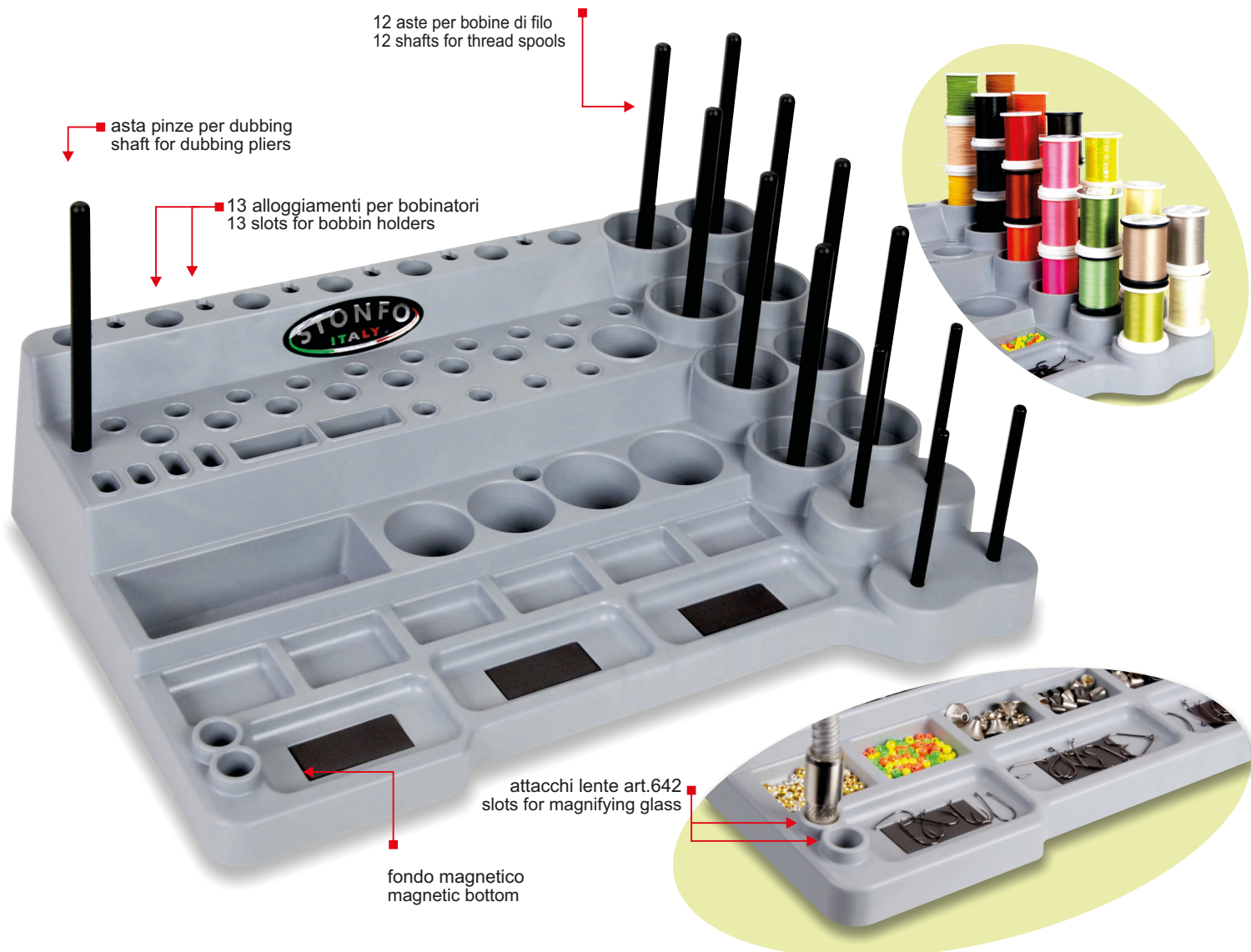





NEW PRODUCTS 2026 FLY FISHING

Art.762 SPOOL BANDS

 *Elastici piatti per bobine, studiati per tenere il filo in ordine e pronto all'uso. Muniti di boccola in materiale autolubrificante che garantisce un perfetto scorrimento del filo. La speciale linguetta agevola sia l'avvolgimento che l'estrazione del filo. Disponibili in due misure.*

 *Flat elastic bands for spools, designed to keep line organized and ready to use. Equipped with a self-lubricating bushing which ensures perfect line sliding. The special tab facilitates both the winding and the extraction of the line. Available in two sizes.*

 *Bandes élastiques plates pour bobines, conçues pour maintenir le fil organisé et prêt à l'emploi. Dotées d'une bague autolubrifiante pour assurer un guidage parfait du fil. La languette spéciale facilite l'enroulement et l'extraction du fil. Disponibles en deux tailles.*

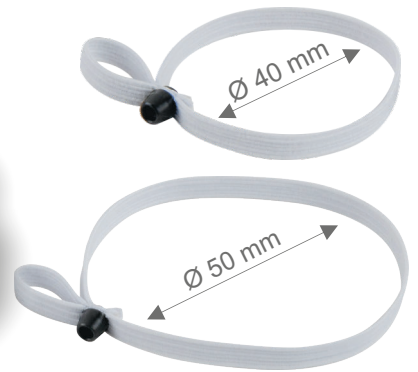



Size 1	Ø 40 mm	height 5 mm
Size 2	Ø 50 mm	height 5 mm

BUSTA DA 5 PEZZI - CONFEZIONE DA 5 BUSTE * 5 PIECES PER BAG - PACK SIZE 5 BAGS

Art.551 TIPPET HOLDER

 *Utile accessorio per tenere insieme e pronte all'uso varie bobine di filo. Appendibile al gilet da pesca. Fornito completo di cinque speciali elastici fermafilo muniti di boccola autolubrificante e linguetta per agevolare sia l'avvolgimento che l'estrazione del filo. Bobine non incluse.*

 *Useful tool that holds together and ready to use several tippet spools. It can be attached to the vest. Supplied with five special elastic bands with a self-lubricating bushing and a tab that facilitates both the winding and the extraction of the line. Spools not included.*

 *Le porte-bobines peut être agrafé directement au gilet pour avoir les bas de ligne à portée de la main. Livré avec cinq élastiques spéciaux bloque-fil équipés d'une bague autolubrifiante et d'une languette pour faciliter à la fois l'enroulement et l'extraction du fil. Bobines non incluses.*

BUSTA DA 1 PEZZO - CONFEZIONE DA 10 BUSTE
1 PIECE PER BAG - PACK SIZE 10 BAGS



Art.764 DUBBING LOOP KIT

 *Kit di utensili per la realizzazione di dubbing in asola utilizzando peli e piume di vario tipo. Il kit comprende:*

- Un blocchetto con intagli di differente lunghezza per piegare agevolmente le piume.
- Due pinze, una di 28 ed una di 49 mm, che permettono una salda presa di peli e piume di vario tipo.
- Un hair compactor per riunire in un mazzetto compatto peli e fibre di piume.

 *Tool kit for making dubbing loop using various types of hair and feathers. The kit includes:*

- One block with grooves of different length to easily fold the feathers.
- Two hair clips, one of 28 and one of 49 mm, that allow a firm grip of various types of hair and feathers.
- One hair compactor to bring together in a compact bunch hair and feather fibers.

 *Kit d'outils pour la réalisation du dubbing en boucle avec différents types de poils et plumes. Le kit comprend :*

- Un bloc avec rainures de différentes longueurs pour plier facilement les plumes.
- Deux pinces, un de 28 et un de 49 mm, qui permettent une prise ferme de différents types de poils et de plumes.
- Un hair compactor pour réunir dans un groupe compact poil et fibres de plumes.

SCATOLA DA 1 PEZZO - CONFEZIONE DA 6 PEZZI
1 PIECE PER BOX - PACK SIZE 6 BOXES





NEW PRODUCTS 2025 FLY FISHING

Art.759 **MICRO PLIER** MICRO PINZA - MICRO PINCE

Pinza studiata per schiacciare l'ardiglione di ami di misura medio piccola senza forzare e danneggiare l'amo. Grazie alle sue ganasce in acciaio temprato piatte e sottili questa pinza risulta ideale anche nella slamatura. Impugnatura anatomica. Dimensioni ridotte, lunghezza cm 10. Leggerissima solo gr 36.

Plier designed to crush the barb of medium and small hooks without forcing or damaging the hooks. Thanks to its flat and thin hardened steel jaws, this plier are also excellent for removing hook from fish. Anatomic handle. Ultra compact design, length cm 10. Ultra lightweight 36 grams only.

Pince conçue pour écraser l'ardillon des hameçons de taille moyenne et petite sans forcer et endommager l'hameçon. Grâce à ses becs en acier trempé plats et fins, cette pince est également idéale pour décrocher vos hameçons dans la gueule du poisson. Poignée anatomique. Très petite, longueur cm 10. Très légère seulement gr 36.



BUSTA DA 1 PZ. - CONF. DA 5 BU. * 1 PIECE PER BAG - PACK SIZE 5 BAGS

Art.750 **HACKLE GAUGE**

CALIBRO PER PIUME - CALIBRE À PLUME

Il Calibro per piume aiuta a scegliere la misura delle piuma o dell'amo in modo semplice e rapido. Basta far girare la piuma sul perno in plastica e leggere sulla scala curva la misura dell'amo appropriata. La grafica indica chiaramente le misure degli ami dal 4 al 22 e la colorazione della scala permette una buona visualizzazione sia con piume chiare che scure. Può essere applicato direttamente allo stelo del morsetto ed essere ruotato quando non si usa.

The Hackle Gauge helps to choose the hackle or hook size quickly and easily. Just bend an hackle around the plastic pin and read the appropriate hook size on the curved scale. The graphic clearly indicates the sizes of the hooks from 4 to 22 and the colors of the curved scale allow a good view with both light and dark hackles. It can be applied directly to the vise stem and can be rotated when not in use.

Le calibre à plume vous aide à choisir la taille de la plume ou de l'hameçons rapidement et facilement. Faites simplement tourner la plume sur la tige en plastique et lisez la taille de l'hameçon approprié sur l'échelle ronde. Le graphisme indique clairement les tailles d'hameçons de 4 à 22 et les couleurs de l'échelle permettent une bonne visualisation des plumes claires et foncées. Il se fixe directement sur la tige de l'étau et peut être tourné lorsqu'il n'est pas utilisé.



BUSTA DA 1 PZ. - CONF. DA 5 BU.
1 PIECE PER BAG - PACK SIZE 5 BAGS

BOX 260x190x26

Art.732

1 scomparto
1 compartment
1 case

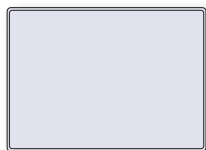

Art.742

6 scomparti
6 compartments
6 cases

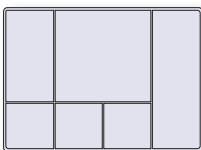

Art.743

12 scomparti
12 compartments
12 cases

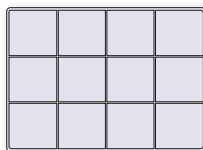

Scatole in materiale plastico leggere e resistenti. Ideali per riporre utensili, materiale di montaggio, ami e minuteria varia. Dim. 26x19x2,6 cm.

Shockproof lightweight plastic boxes. Suitable to store tools, tying material, hooks and small rigs. Dim. 26x19x2.6 cm.

Boîtes en plastique légères et antichoc. Idéales pour ranger outils, matériau de montage, hameçons et divers petits accessoires. Dim. 26x19x2,6 cm.



CONFEZIONE DA 5 PEZZI * PACK SIZE 5 PIECES

Art.741

STONFO FLY TYING KIT



Set composto da un morsetto Flylab e 7 utensili per la costruzione di mosche artificiali e streamers. Fornito in una robusta scatola la cui interno in gomma è sagomato per dare ad ogni utensile un preciso alloggiamento. Contenuto: Morsetto Flylab, Forbicine, bobinatore Bobtec1 con tensionamento del filo regolabile, Passafilo, Annodatore-Annodatore conico, Spillo di montaggio, Pinza per hackles, Rotodubbing mini, chiave a brugola. All'interno dettagliate istruzioni per l'uso del morsetto e dei vari utensili.



Complete set which includes a Flylab vise and 7 fly tying tools. Supplied in a strong case whose rubber interior is shaped to give each tool a precise housing. Contents: Flylab vise, small Scissor, Bobtec1 bobbin with adjustable thread tension, Bobbin threader, Finisher-Conical finisher, Bodkin, Hackle pliers, Rotodubbing mini, Allen Key. Inside detailed instructions of the vise and various tools.



Set complet de étaux Flylab and 7 outils pour le montage de mouches et streamers. Livré dans une boîte robuste avec l'intérieur en mousse découpée pour donner à chaque outil un logement précis. Le set comprend: étaux Flylab, petits Ciseaux, porte-bobine Bobtec1 avec curseur pour régler la tension du fil, Passe-fil, Finisseur-Finisseur conique, Aiguille à dubbing, Pince à Hackles, Rotodubbing mini, clé Allen. Instructions détaillées à l'intérieur pour l'utilisation de l'étaux et des différents outils.

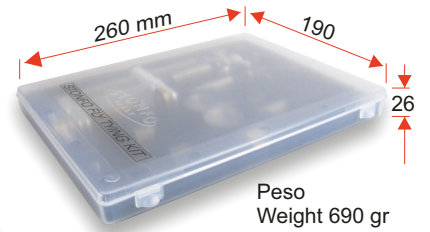

INCLUDES:

- STONFO FLYLAB VISE WITH ALLEN KEY
- STONFO FINISHER-CONICAL FINISHER
- STONFO BOBBIN THREADER
- STONFO BODKIN
- SMALL SCISSORS
- STONFO HACKLE PLIERS
- STONFO BOBTEC1 BOBBIN
- STONFO ROTODUBBING MINI

CONFEZIONE DA 1 PEZZO * PACK SIZE 1 PIECE



Art.744

STEELTECH BOBBIN



Bobinatore prodotto completamente in acciaio inox con struttura ergonomica molto robusta. Il suo peso di 35 grammi aiuta a mantenere un buon tensionamento del filo di montaggio. Il perno passante garantisce la massima stabilità della bobina mentre i due pomelli consentono una perfetta regolazione della tensione. Il tubetto scorrevole ha alla sua estremità una boccia in acciaio temprato resistentissima all'usura e agli urti. Questo bobinatore risulta perfettamente bilanciato durante la rotazione ed è quindi ideale per la realizzazione di dubbing.



Bobbin holder made entirely of stainless steel with a sturdy ergonomic structure. Its weight of 35 grams helps to maintain a good tension on the tying thread. The central shaft guarantees the maximum stability of the spool, while the two knobs allow the perfect adjustment of the tension. Tube with very strong hardened steel bush to prevent fraying. This bobbin holder is perfectly balanced during rotation and is therefore ideal for dubbing.



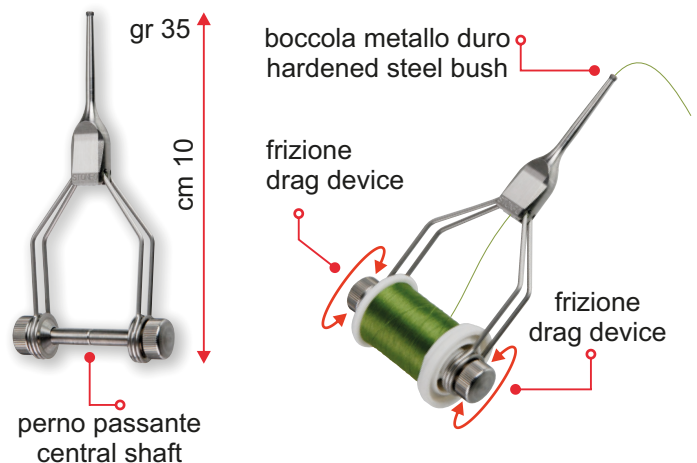

Porte bobine entièrement réalisé en acier inox avec structure ergonomique très robuste. Son poids de 35 grammes permet de maintenir une bonne tension du fil de montage. L'arbre central garantit une stabilité maximale de la bobine, tandis que les deux boutons permettent un réglage parfait de la tension. Tube glisse-fil avec tulipe en acier trempé très dur. Ce porte bobine est parfaitement équilibré lors de la rotation et est donc idéal pour le dubbing.



BUSTA DA 1 PZ - CONF. DA 5 BUSTE * 1 PCS PER BAG - PACK SIZE 5 BAGS

Art.740 MAGNETIC MATERIAL CLIP

 Clip magnetica utilissima per bloccare filo ed altro materiale durante il montaggio. La clip blocca ugualmente bene sia fili sottilissimi che molto voluminosi. Grazie alla sua potente calamita si applica rapidamente alla pinza del morsetto o in qualsiasi altra parte metallica attrattiva.

 Clip very useful to hold threads and materials during the tying. The clip holds well both very thin and very voluminous threads. Thanks to its powerful magnet it can be applied quickly to the jaws of the vise or to any other attractive metal part.

 Clip magnétique très utile pour bloquer les fils et autres matériaux lors du montage. Le clip bloque aussi bien les fils très fins que les fils très volumineux. Grâce à son aimant puissant, il s'applique rapidement sur le mors de l'étau ou sur toute autre pièce métallique attrayante.

BUSTA DA 1 PZ - CONF. DA 10 BUSTE * 1 PCS PER BAG - PACK SIZE 10 BAGS

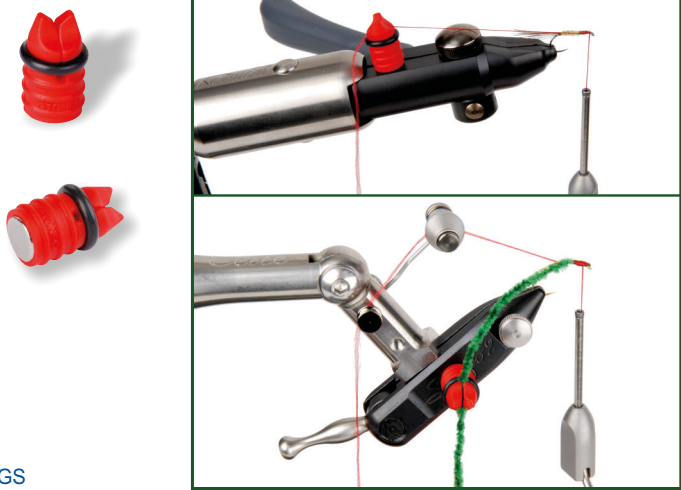

Art.745 STREAMER BOBBIN

 Bobinatore di grandi dimensioni con impugnatura ergonomica appositamente studiato per la realizzazione di grandi artificiali e streamers. La sua struttura è realizzata completamente in acciaio inox per garantire la massima robustezza.

Il suo peso di 42 grammi aiuta a mantenere un ottimo tensionamento del filo di montaggio. La bobina viene inserita stabilmente su un perno passante munito di due pomelli che consentono una perfetta regolazione della tensione. Il tubetto scorri-filo, con boccola in acciaio temprato, ha un diametro maggiorato per consentire l'uso di filati voluminosi come floss, microciniglie etc. Questo bobinatore risulta perfettamente bilanciato durante la rotazione ed è quindi ideale per la realizzazione di dubbing.

 Big size bobbin holder with ergonomic handle specially designed for tying large lures and streamers. Its sturdy structure is made entirely of stainless steel. Its weight of 42 grams helps to maintain a good tension on the tying thread. The central shaft guarantees the maximum stability of the spool, while the two knobs allow the perfect adjustment of the tension. The large tube, with hardened steel bush, allows the use of voluminous materials like floss, microchenille etc. This bobbin holder is perfectly balanced during rotation and is therefore ideal for dubbing.

 Porte bobine de grandes dimensions avec poignée ergonomique spécialement conçu pour la création de gros leurres et streamers. Sa structure est entièrement réalisée en acier inox pour assurer une robustesse maximale. Son poids de 42 grammes permet de maintenir une bonne tension du fil de montage. L'arbre central garantit une stabilité maximale de la bobine, tandis que les deux boutons permettent un réglage parfait de la tension. Le tube de grand diamètre, avec tulpine en acier trempé, permet l'emploi de matériaux volumineux comme floss, chenille, etc. Ce porte bobine est parfaitement équilibré lors de la rotation et est donc idéal pour le dubbing.

BUSTA DA 1 PZ - CONF. DA 5 BUSTE * 1 PCS PER BAG - PACK SIZE 5 BAGS

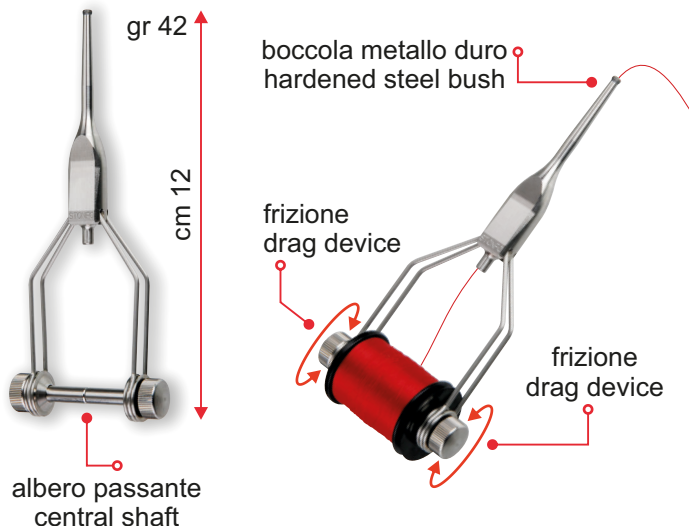

Art.746 ANGLE JOINT

 Giunto in acciaio inox con regolazione angolare. La confezione include 1 giunto, 1 asta di estensione lunga 145 mm e 1 chiave a brugola. Questo accessorio permette di:

- 1) avvicinare la testa del morsetto al costruttore
- 2) bloccare l'asta di supporto bobinatore-parachute nella posizione e angolazione desiderata.
- 3) aumentare lo spazio di lavoro del morsetto grazie all'asta di estensione. Adatto per tutti i morsetti con base o morsa da tavolo muniti di asta da 8 a 10 mm (3/8") e per aste di supporto da 3 a 5 mm.

 Stainless steel joint with angular adjustment. The packaging includes 1 joint, 1 extension stem 145 mm long and 1 allen key. This accessory allows to:

- 1) bring the vise head closer to the fly tyer.
- 2) lock the bobbin-parachute attachment at the desired angle and position.
- 3) increase the working space of the vise thanks to the extension stem. Suitable for every vise with base or table clamp equipped with stem from 8 to 10 mm (3/8") and for attachment stems from 3 to 5 mm.

 Joint en acier inox avec réglage angulaire. L'emballage comprend 1 joint, 1 tige d'extension longue 145mm et 1 clé allen. Cet accessoire vous permet de:

- 1) rapprocher la tête de l'étau au monteur.
- 2) bloquer la tige support parachute-porte bobine dans la position et l'angle souhaités.
- 3) augmenter l'espace de travail de l'étau grâce à la tige d'extension. Utilisable sur tous les étaux avec socle ou pince de table équipés de tige de 8 à 10 mm (3/8") et pour tiges de support de 3 à 5 mm.

CONFEZIONE DA 1 PEZZO * PACK SIZE 1 PIECE

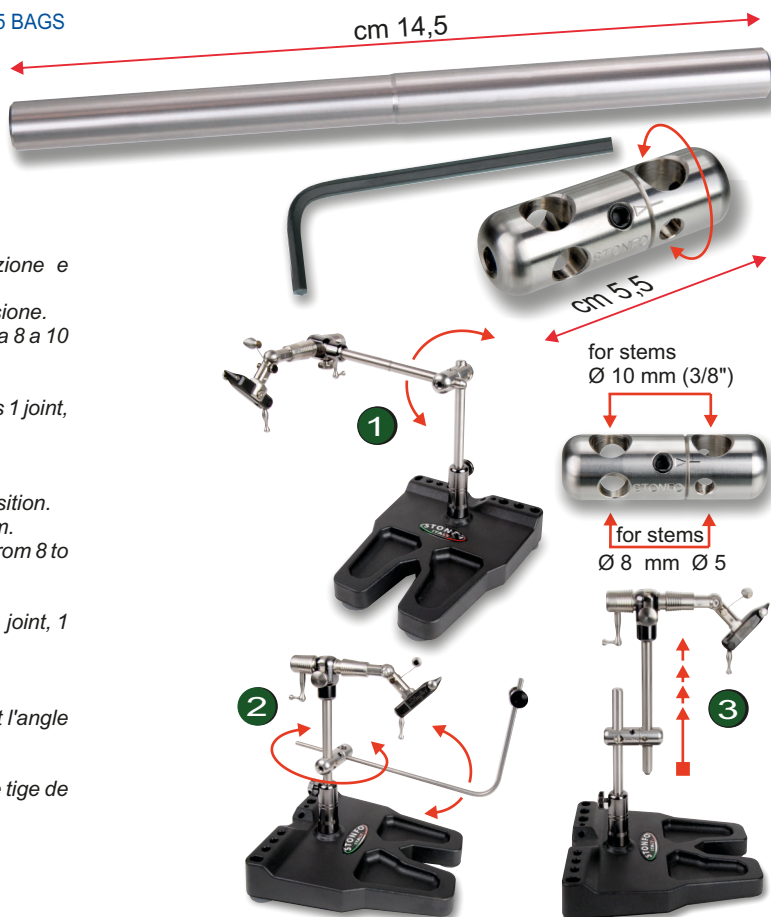

MORSETTI FLYLAB FLYLAB VISES



Morsetto di alta qualità per la costruzione di mosche ed esche artificiali con testa inclinabile completamente rotante a 360°. Frizione regolabile sul movimento di rotazione. Bloccaggio testa 0°-180°. Pinza intercambiabile in acciaio temprato mis.media. Leggero e poco ingombrante.

Art 475: fornito completo di C Clamp (per fissaggio su tavola con piano fino a 50 mm di spessore), spirale di bloccaggio, chiave a brugola e istruzioni per l'uso.

Art 476: fornito completo di base con nicchie, spirale di bloccaggio, chiave a brugola e istruzioni per l'uso.



High quality rotary vise for tying flies and streamers. Infinite head angle adjustment and 360° rotary action. Adjustable rotary tension. Locking of the head 0°-180°. Interchangeable hardened steel jaw (medium size). Compact and lightweight.

Item 475: supplied with C Clamp (for any table up to 50 mm thick), spring material clip, allen key and instruction manual.

Item 476: supplied with pedestal base, spring material clip, allen key and instruction manual.



Étau d'haute qualité pour le montage de mouches. Tête inclinable et rotative à 360°. Tension de la rotation réglable. Blocage de la tête 0°-180°. Mors interchangeable en acier trempé (taille moyenne). Petit et léger.

Art 475: livré avec C Clamp (pour fixation sur tables de 50 mm max d'épaisseur), ressort fixe fil, clé Allen et notice d'emploi.

Art 476: livré avec socle, ressort fixe fil, clé Allen et notice d'emploi.

CONFEZIONE DA 1 PEZZO - PACK SIZE 1 PIECE

Art.504

MORSETTO FLYLAB LEVA FLYLAB LEVER VISE



Morsetto di alta qualità per la costruzione di mosche ed esche artificiali, con testa inclinabile completamente rotante a 360°. Sistema di bloccaggio dell'amo a leva. Frizione regolabile sul movimento di rotazione. Bloccaggio testa 0°-180°. Leggero e poco ingombrante. Fornito completo di base da tavolo con nicchie, morsa per fissaggio su banco, 3 pinze intercambiabili in acciaio temprato, spirale di bloccaggio, chiave a brugola e istruzioni per l'uso.



High quality rotary vise for tying flies and streamers. Hook locking by lever device. Infinite head angle adjustment and 360° rotary action. Adjustable rotary tension. Locking of the head 0°-180°. Compact and lightweight. Supplied with pedestal base, C clamp, 3 interchangeable hardened steel jaws, spring material clip, allen key and instruction manual.



Étau d'haute qualité pour le montage de mouches. Blocage de l'hameçon à levier. Tête inclinable et rotative à 360°. Tension de la rotation réglable. Blocage de la tête 0°-180°. Petit et léger. Livré avec socle, dispositif de fixation sur table, 3 mors interchangeables en acier trempé, ressort fixe fil, clé Allen et notice d'emploi.

CONFEZIONE DA 1 PEZZO - PACK SIZE 1 PIECE

MORSETTI FLYTEC FLYTEC VISES



Morsetto rotante in asse a 360° di alta qualità per la costruzione di mosche ed esche artificiali con albero porta testa in acciaio inox supportato da due cuscinetti a sfera di precisione. Frizione regolabile sul movimento di rotazione. Bloccaggio testa a 0°. Leggero e poco ingombrante.

Art 477: fornito completo di C Clamp (per fissaggio su tavola con piano fino a 50 mm di spessore), 3 pinze intercambiabili in acciaio temprato, supporto bobinatore e parachute, centratore, spirale di bloccaggio, chiave a brugola e istruzioni per l'uso.

Art 478: fornito completo di base con nicchie, 3 pinze intercambiabili in acciaio temprato, supporto bobinatore e parachute, centratore, spirale di bloccaggio, chiave a brugola e istruzioni d'uso.



High quality in-line 360° rotary action vise for tying flies and streamers. The stainless steel shaft rotates through two precision ball bearings. Adjustable rotary tension. Locking of the head at 0°. Compact and lightweight.

Item 477: supplied with C Clamp (suitable for any table top up to 50 mm thick), 3 interchangeable hardened steel jaws, bobbin and parachute rest, centering gauge, spring material clip, allen key and instruction manual.

Item 478: supplied with pedestal base, 3 interchangeable hardened steel jaws, bobbin and parachute rest, centering gauge, spring material clip, allen key and instruction manual.



Étau d'haute qualité rotatif en axe à 360° pour le montage de mouches. Arbre en acier inox monté sur deux roulements à billes de précision. Tension de la rotation réglable. Blocage de la tête à 0°. Petit et léger.

Art 477: livré avec C Clamp (pour fixation sur tables de 50 mm max d'épaisseur), 3 mors interchangeables en acier trempé, support repose-bobine et parachute, dispositif centreur pour l'alignement rapide de l'hameçon, ressort fixe fil, clé Allen et notice d'emploi.

Art 478: livré avec socle, 3 mors interchangeables en acier trempé, support repose-bobine et parachute, dispositif centreur pour l'alignement rapide de l'hameçon, ressort fixe fil, clé Allen et notice d'emploi.

CONFEZIONE DA 1 PEZZO - PACK SIZE 1 PIECE

Art.475

FLYLAB
C CLAMP



Art.476

FLYLAB
BASE

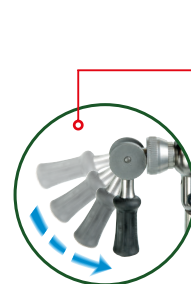

Serraggio dell'amo a leva
Lever action to lock the hook
Blocage de l'hameçon à levier



Art.477

FLYTEC
C CLAMP





Art.478

FLYTEC
BASE



Art.516 **MORSETTO FLYTEC LEVA** FLYTEC LEVER VISE

 Morsetto rotante in asse a 360° di alta qualità per la costruzione di mosche ed esche artificiali con albero porta testa in acciaio inox supportato da due cuscinetti a sfera di precisione. Sistema di bloccaggio dell'amo a leva. Frizione regolabile sul movimento di rotazione. Bloccaggio testa a 0°. Leggero e poco ingombrante. Fornito completo di base con nicchie, C Clamp (per fissaggio su tavola con piano fino a 50 mm di spessore), 3 pinze intercambiabili in acciaio temprato, supporto bobinatore e parachute, centratore, spirale di bloccaggio, chiave a brugola e istruzioni d'uso.

 High quality in-line 360° rotary action vise for tying flies and streamers. The stainless steel shaft rotates through two precision ball bearings. Hook locking by lever device. Adjustable rotary tension. Locking of the head at 0°. Compact and lightweight. Equipped with pedestal base, C Clamp (suitable for any table top up to 50 mm thick), 3 interchangeable hardened steel jaws, bobbin and parachute rest, centering gauge, spring material clip, allen key and instruction manual.

 Étau d'haute qualité rotatif en axe à 360° pour le montage de mouches et leurres. Arbre en acier inox monté sur deux roulements à billes de précision. Blocage de l'hameçon à levier. Tension de la rotation réglable. Blocage de la tête à 0°. Petit et léger. Livré avec socle, C Clamp (pour fixation sur tables de 50 mm max d'épaisseur), 3 mors interchangeables en acier trempé, support repose-bobine et parachute, dispositif centreur pour l'alignement rapide de l'hameçon, ressort fixe fil, clé Allen et notice d'emploi.

Serraggio dell'amo a leva
Lever action to lock the hook
Blocage de l'hameçon à levier

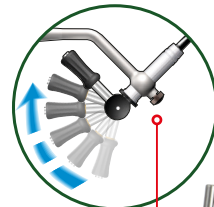

Volantino in acciaio
Steel handwheel
Volant en acier

Altezza regolabile
Adjustable height
Hauteur réglable

Piedini antiscivolo
Antiskid rubber feet
Pieds anti-dérapants

Leva in acciaio
Steel lever
Levier en acier

CONFEZIONE DA 1 PEZZO - PACK SIZE 1 PIECE

Art.610 **MORSETTO TUBEFLY** TUBEFLY VISE

 Morsetto speciale di alta precisione realizzato espressamente per il montaggio delle tubeflies. Il gruppo testa, dalla forma affusolata ergonomica, è montato su due cuscinetti di precisione che ne consentono una rapida rotazione in asse a 360° agevolata ulteriormente dallo speciale volantino a doppio diametro. Le astine in acciaio inox in dotazione al morsetto, 3 coniche e 2 cilindriche con blocco terminale, sono finemente lavorate su macchine cnc e permettono di serrare sul morsetto una grande varietà di tubetti.

Altre importanti caratteristiche di questo morsetto sono: testa regolabile nell'inclinazione, frizione regolabile sul movimento di rotazione, bloccaggio testa 0°-180°, regolazione in altezza. Fornito completo di base con nicchie, molla di bloccaggio materiale, chiave a brugola e istruzioni per l'uso.

 High precision tubefly vise designed to tie on a wide range of tube sizes. The shaft is in-line full rotary thanks to dual precision ball bearings. The ergonomic head shape and the double diameter handwheel improve its functionality. The tubefly vise includes 3 accurately machined conical pins and 2 cylindrical pins for tying on all types of tubes. Other features: adjustable tying angle, adjustable rotary tension, locking position 0°-180°, adjustable height. Supplied with pedestal base, spring material clip, allen key and instruction manual.

 Étau tubefly d'haute précision pour le montage des mouches tubes. Le mandrin est rotatif en axe à 360° grâce à deux roulements à billes de précision, son forme fuselé ergonomique et le volant à double diamètre améliorent la fonctionnalité. L'étau est fourni avec 3 tiges spécifiques de diamètre décroissant et 2 tiges cylindriques qui s'adaptent aux différents diamètres des tubes. Autres caractéristiques: tête orientable, tension de la rotation réglable, blocage de la tête 0°-180°, réglable en hauteur. Livré avec socle, ressort fixe matériel, clé allen et notice d'emploi.

CONFEZIONE DA 1 PEZZO - PACK SIZE 1 PIECE

Art.609 **MORSETTO KAIMAN**

KAIMAN VISE

 Morsetto di alta precisione consente di bloccare solidamente qualsiasi tipo di amo in un istante. E' sufficiente tirare la leva per aprire la pinza, posizionare l'amo e rilasciare la leva senza bisogno di alcuna regolazione. La pinza è realizzata in acciaio speciale temperato ed il suo particolare profilo è stato studiato per accogliere una vastissima gamma di misure di ami, dai piccolissimi del 28 fino ai grandi da mare del 5/0. Il gruppo porta-pinza è montato su due cuscinetti di precisione che ne consentono una fluida rotazione a 360° agevolata dallo speciale volantino a doppio diametro.

Altre importanti caratteristiche di questo morsetto sono: leva di azionamento con impugnatura ergonomica, testa regolabile nell'inclinazione, frizione regolabile sul movimento di rotazione, bloccaggio testa 0°-180°, regolazione in altezza, riposizionamento leva per mancini. Fornito completo di base con nicchie, molla di bloccaggio materiale, chiavi a brugola e istruzioni per l'uso.

 High precision vise for a fast hook changing. To use simply squeeze the lever and insert the hook into the jaw. When you release the lever the hook will be held firmly in the vise. The hardened steel jaw is designed to hold hooks ranging from tiny size 28 to mighty 5/0 saltwater hooks with no adjustments. Other features: lever with anatomic handle, 360° rotary action with dual precision ball bearings, double diameter handwheel, adjustable rotary tension, locking position 0°-180°, adjustable tying angle, adjustable height. The lever can be set up for both left and right handed use. Supplied with pedestal base, spring material clip, allen keys and instruction manual.

 Étau d'haute précision avec serrage forte et rapide de l'hameçon par simple pression sur le levier. Le mors en acier trempé s'adapte à toutes les tailles d'hameçons à partir du petit 28 au plus grand hameçon mer de 5/0 sans nécessiter d'aucun réglage. La tête porte-mors est rotative à 360° grâce à deux roulements à billes de précision. Le volant à double diamètre facilite considérablement la rotation. Autres caractéristiques: levier avec poignée anatomique, tête orientable, tension de la rotation réglable, blocage de la tête 0°-180°, réglable en hauteur, convertible droitier-gaucher. Livré avec socle, ressort fixe matériel, clés allen et notice d'emploi.

CONFEZIONE DA 1 PEZZO - PACK SIZE 1 PIECE



Leva di apertura-chiusura
Opening-closing lever
Levier d'ouverture

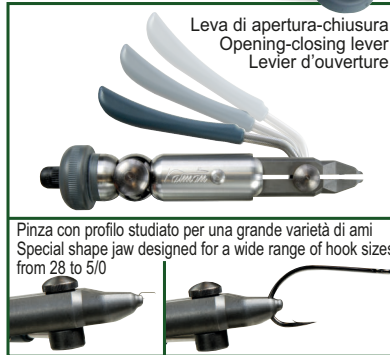

Pinza con profilo studiato per una grande varietà di ami
Special shape jaw designed for a wide range of hook sizes
from 28 to 5/0

ELITE VISE

Morsetto rotante in asse a 360° di alta qualità per la costruzione di mosche ed esche artificiali con albero porta pinza in acciaio inox supportato da due cuscinetti a sfera di precisione. L'albero porta pinza snodato permette l'allineamento del gambo dell'amo all'asse di rotazione. La base di cui è dotato è molto stabile ed è munita di nicchie e di un pratico porta utensili integrato. Altre importanti caratteristiche: intercambiabilità della pinza, bloccaggio dell'amo mediante leva ad azione "super soft", frizione progressiva sul movimento di rotazione, blocco della rotazione in qualsiasi posizione, regolazione in altezza, adattamento per mancini. Altri prodotti inclusi: supporto bobinatore-parachute in acciaio inox sagomato ad U con pinzetta parachute e accessori, molla blocca-materiale regolabile, perno di supporto filo di montaggio, chiavi a brugola e istruzioni d'uso.



High quality in-line 360° rotary action vise for tying flies and streamers. The stainless steel shaft rotates through two precision ball bearings. The shank of the hook rotates on axis thanks to the adjustable shaft. The steady pedestal base has a useful integrated tool rack. Other important features: interchangeable jaws, hook locking by "super soft" lever device, adjustable rotary tension, smooth rotary motion, locking position at any angle, adjustable height, reversible for left hand tying. Other accessories included: rounded shape bobbin cradle, parachute plier, adjustable spring material clip, pivot thread cradle, allen keys and instruction manual.



Étau d'haute qualité rotatif en axe à 360° pour le montage de mouches et leurres. L'arbre en acier inox, monté sur deux roulements à billes de précision, est articulé et permet l'alignement de la tige de l'hameçon à l'axe de rotation. Socle stable avec poches et porte-outils intégré. Autres caractéristiques importantes: mors interchangeable, blocage de l'hameçon à levier "super soft", tension de la rotation réglable, blocage de rotation à n'importe quel position, réglable en hauteur, convertible droitier-gaucher. Autres accessoires inclus: bras de support repose-bobine de forme arrondie, pince "parachute", ressort fixe matériel réglable, pivot support fil, clés allen, notice d'emploi.

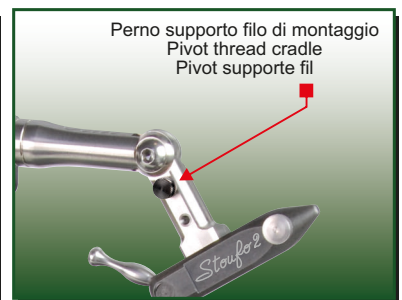
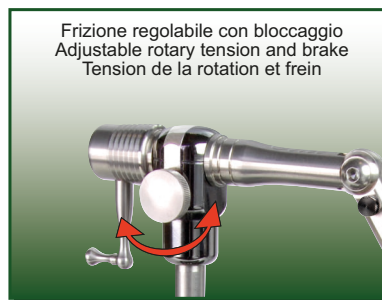
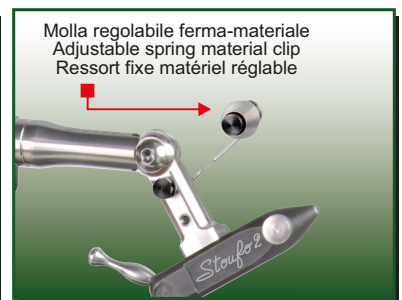
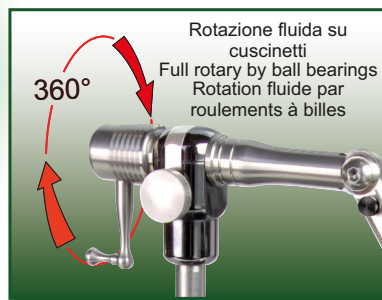

Base stabile, regolabile in altezza, con porta-utensili integrato e attacco per lente d'ingrandimento art.642 (utensili e lente non inclusi).



Adjustable height pedestal base with integrated tool rack and magnifying glass connection nr.item 642 (tools and magnifying glass not included).



Socle réglable en hauteur avec porte-outils intégré et jonction pour loupe. (outils et loupe pas inclus).



L'albero porta-pinza snodato permette l'allineamento del gambo dell'amo all'asse di rotazione.



The shank of the hook rotates on axis thanks to the adjustable angle shaft.



L'arbre articulé porte-mors permet l'alignement de la tige de l'hameçon à l'axe de rotation.



Il Transformer è un prodotto di alta qualità che, grazie ad un dispositivo innovativo di sgancio rapido dell'albero, si trasforma in un attimo in un morsetto in-linea o in un morsetto per la costruzione di tube-fly oppure in un morsetto per la realizzazione di streamers. Tre morsetti in uno con un semplice click. Costruito in acciaio inox con albero rotante su cuscinetti per una fluida rotazione. Tutti i componenti che compongono i tre morsetti sono inclusi con il Transformer. La base molto stabile è munita di nicchie e di un pratico porta utensili integrato con attacco per lente d'ingrandimento art. 642 (utensili e lente non inclusi). Altre importanti caratteristiche del Transformer sono: intercambiabilità delle pinze, frizione progressiva sul movimento di rotazione, blocco della rotazione in qualsiasi posizione, blocco rapido della rotazione a step di 45°, regolazione in altezza, adattamento per mancini. Altri accessori inclusi: supporto bobinatore-parachute in acciaio inox sagomato ad U con pinzetta parachute e accessori, molla blocca-materiale regolabile, perno di supporto, chiavi a brugola e istruzioni d'uso.



The Transformer is a high quality product that thanks to a fast coupling device on the shaft can be transformed from in-line vise to tube-fly vise or streamer vise. Three vises in one with just a click. The stainless steel shaft is in-line full rotary by dual precision ball bearings. All parts of three vises are included with Transformer. The steady pedestal base has a useful integrated tool rack and connection for magnifying glass item 642 (tools and magnifying glass not included). Other important Transformer features: interchangeable jaws, adjustable rotary tension, smooth rotary motion, locking position at any angle, shaft fast locking every 45° angle, adjustable height, reversible for left hand tying. Other accessories included: rounded shape bobbin cradle, parachute plier, adjustable spring material clip, pivot thread cradle, allen keys and instruction manual.



Le Transformer est un produit de haute qualité qui, grâce à un dispositif innovant de déclenchement rapide de l'arbre, se transforme à l'instant en étau in-axe, ou en étau pour le montage des mouches-tubes ou en étau étudié pour la réalisation des streamers. Trois étaux en un avec un simple clic. L'arbre est en acier inox monté sur deux roulements à billes de précision. Tous les éléments qui composent les trois étaux sont fournis avec le Transformer. Socle stable avec poches et porte-outils intégré avec jonction pour loupe art. 642 (outils et loupe pas inclus). Autres caractéristiques importantes: mors interchangeables, tension de la rotation réglable, blocage de rotation à n'importe quel position, blocage rapide chaque 45°, réglable en hauteur, convertible droitier-gaucher. Autres accessoires inclus: bras de support repose-bobine de forme arrondie, pince "parachute", ressort fixe matériel réglable, pivot support fil, clés allen, notice d'emploi.

CONFEZIONE DA 1 PEZZO - PACK SIZE 1 PIECE

3 MORSETTI IN UNO CON UN CLICK !
3 VISES IN ONE WITH JUST A CLICK !

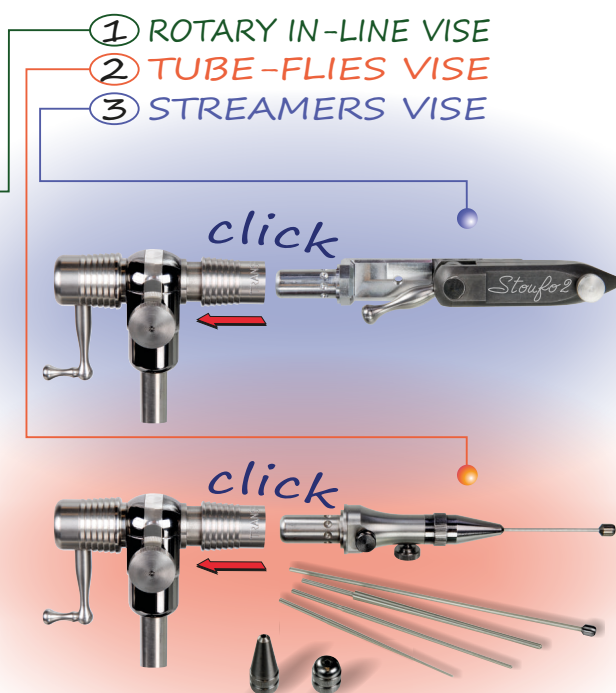

SGANCIO RAPIDO
FAST COUPLING DEVICE
DÉCLENCHEMENT RAPIDE

inserire l'albero
insert the shaft
introduire l'arbre

rilasciare il cursore
release the slider
relâcher le curseur

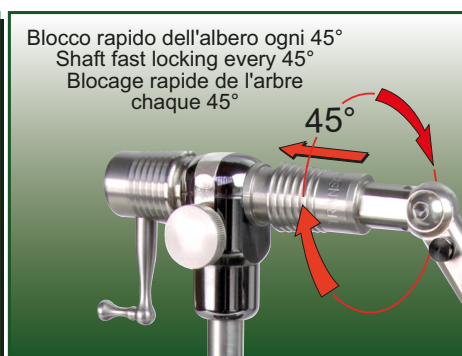
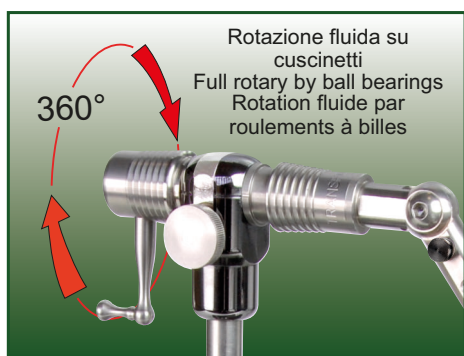
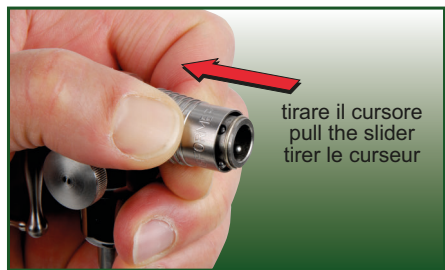

Art.699

MORSETTO AIRONE AIRONE VISE - ÉTAU AIRONE



Morsetto da viaggio per la costruzione di mosche artificiali. Grazie al suo design particolare e ad una serie di snodi esso può essere chiuso e riposto in una apposita scatola di cm 15X10X2 senza che si debba smontare alcun pezzo. La lavorazione accurata e la scelta dei materiali consentono a questo piccolo morsetto di avere prestazioni eccezionali. L'Airone utilizza la stessa efficiente pinza intercambiabile del morsetto Elite. La testa è inclinabile, rotante a 360° e regolabile in altezza. Munito di frizione sul movimento di rotazione con bloccaggio in qualsiasi posizione. Adatto anche per mancini. Fornito completo di chiave a brugola e istruzioni per l'uso.



Travel vise for tying flies and streamers. Thanks to its special design and to a series of articulated joints it can be folded and placed in a special box of cm 15X10X2 without disassembling any piece. The accurate machining and the choice of materials provide exceptional performance to this small vise. The Airone uses the same efficient interchangeable jaw of Elite vise. The head has adjustable angle, 360° rotary action and adjustable height. The rotary tension is adjustable, with locking position at any angle. Suitable for left-handers. Supplied with allen key and instruction manual.



Étau de voyage pour le montage de mouches et leurres. Grâce à son design spécial et à une série de articulations il peut être plié et placé dans une boîte spéciale de cm 15X10X2 sans démonter aucune pièce. L'usinage soigné et le choix des matériaux permettent à ce petit étau d'avoir des performances exceptionnelles. L'Airone utilise le même efficace mors interchangeable de l'étau Elite. La tête est orientable, rotative à 360° et réglable en hauteur. La tension de la rotation est réglable avec blocage à n'importe quel position. Il est également approprié pour les gauchers. Livré avec clés allen et notice d'emploi.

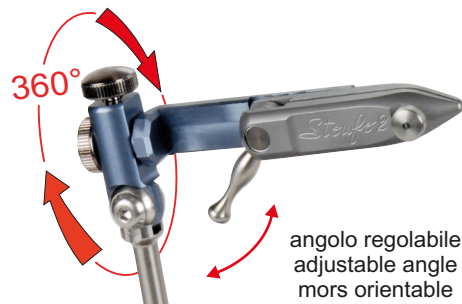

angolo regolabile
adjustable angle
mors orientabile

altezza regolabile
adjustable height
hauteur réglable

LEGERISSIMO
ULTRA-LIGHT
ULTRA-LÉGER Gr 420

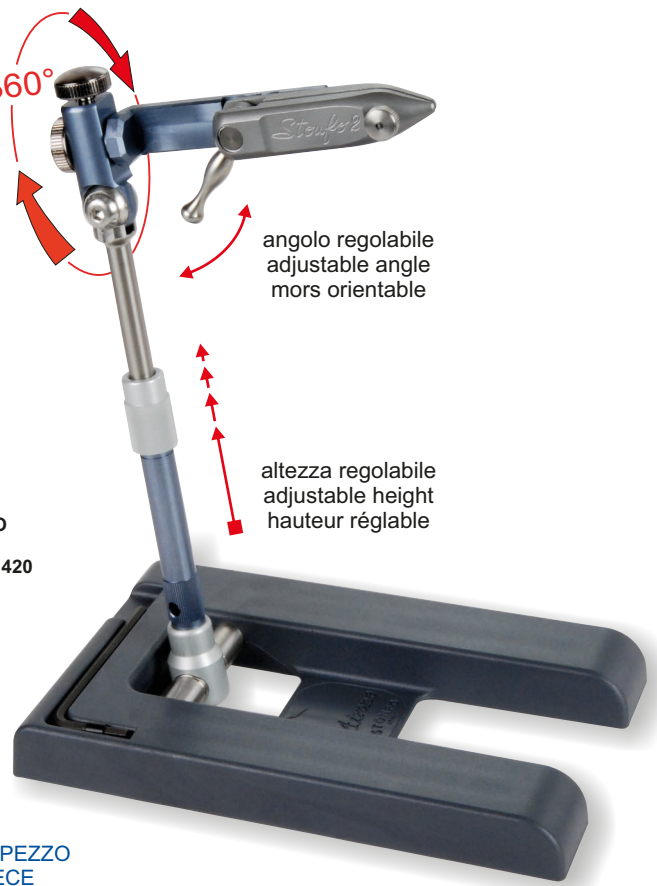

CONFEZIONE DA 1 PEZZO
PACK SIZE 1 PIECE

Art.479

PINZE MORSETTO VISE JAW



Pinze intercambiabili in acciaio temprato per morsetti Stonfo FlyLab e FlyTec. Adatte per ami dal 28 al 4/0. Prodotte in tre misure.



Interchangeable hardened steel jaws for FlyLab and FlyTec Stonfo vises. Suitable for hooks size 28 to 4/0. Available in three sizes.



Mors interchangeables en acier trempé pour hameçons de n°28 à 4/0. Utilisables sur les étaux Stonfo FlyLab et FlyTec. Disponibles en trois tailles.

Mis.1 Ami piccoli- Small hooks



Mis.2 Ami medi-Medium hooks



Mis.3 Ami grandi - Big hooks



CONFEZIONE DA 1 PEZZO - PACK SIZE 1 PIECE

Art.655

PINZA STONFO1 STONFO1 JAW



Pinza intercambiabile in acciaio temprato adatta per morsetto Elite, morsetto Transformer e morsetto Airone. Particolarmente studiata per ami di misura media e piccola. Il bloccaggio dell'amo avviene tramite azionamento a leva "super soft".



Hardened steel interchangeable jaw suitable for Elite vise, Transformer vise and Airone vise. Ideal for tying medium and small flies. Hook locking by lever device "super soft".



Mors interchangeable en acier trempé pour les étaux Elite, Transformer et Airone. Idéal pour hameçons de moyenne et petite taille. Blocage de l'hameçon à levier "super soft".

CONFEZIONE DA 1 PEZZO - PACK SIZE 1 PIECE



pinza con azionamento a leva "super soft"
super soft lever device jaw
mors avec blocage à levier "super soft"

Art.656

PINZA STONFO2 STONFO2 JAW



Pinza intercambiabile in acciaio temprato adatta per morsetto Elite, morsetto Transformer e morsetto Airone. Ideale per la costruzione di mosche e streamers su ogni tipo e misura di amo. Il bloccaggio dell'amo avviene tramite azionamento a leva "super soft".



Hardened steel interchangeable jaw suitable for Elite vise, Transformer vise and Airone vise. Ideal for tying flies and streamers in any type and size of hooks. Hook locking by lever device "super soft".



Mors interchangeable en acier trempé pour les étaux Elite, Transformer et Airone. Idéal pour tous les types et tailles d'hameçons. Blocage de l'hameçon à levier "super soft".

CONFEZIONE DA 1 PEZZO - PACK SIZE 1 PIECE



pinza con azionamento a leva "super soft"
super soft lever device jaw
mors avec blocage à levier "super soft"

Art.484 **BASE TAVOLO** PEDESTAL BASE

 Base universale da tavolo con nicchie per minuteria e piedini in gomma antiscivolo. Munita di 4 boccole intercambiabili per aste di \varnothing 7-8-9-10 mm.

 Antiskid pedestal base with pockets to hold hooks, beads etc. Equipped with 4 interchangeable bushes for stems mm \varnothing 7-8-9-10.

 Socle étau anti-dérapant avec poches pour hameçons, perles etc. Equipé des 4 bagues interchangeables pour tiges de \varnothing 7-8-9-10 mm.



CONFEZIONE DA 1 PEZZO - PACK SIZE 1 PIECE

Art.657 **BASE TRR** TRR PEDESTAL BASE

 Base stabile, regolabile in altezza, con piedini in gomma antiscivolo, porta-utensili integrato e attacco per lente d'ingrandimento art.642 (utensili e lente non inclusi). Munita di 4 boccole intercambiabili per aste di \varnothing 7-8-9-10 mm.

 Antiskid adjustable height pedestal base with integrated tool rack and magnifying glass connection nr.item 642 (tools and magnifying glass not included). Equipped with 4 interchangeable bushes for stems mm \varnothing 7-8-9-10.

 Socle étau anti-dérapant, réglable en hauteur avec porte-outils intégré et jonction pour loupe art. 642. (outils et loupe pas inclus). Equipé des 4 bagues interchangeables pour tiges de \varnothing 7-8-9-10 mm.

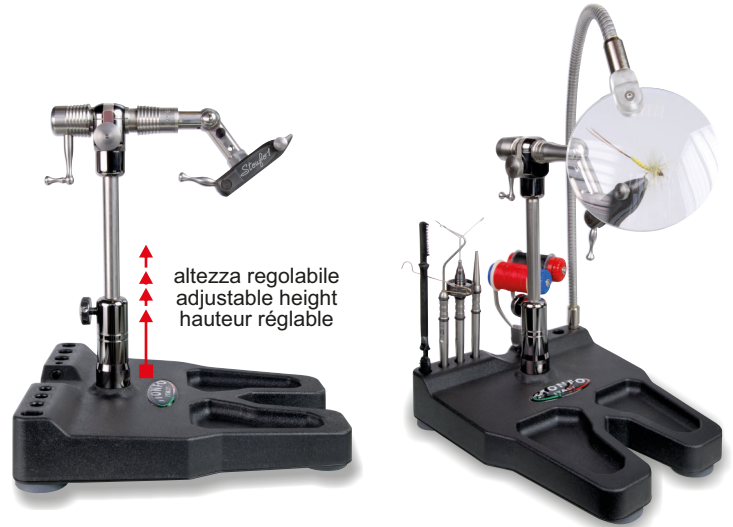



altezza regolabile
adjustable height
hauteur réglable

CONFEZIONE DA 1 PEZZO - PACK SIZE 1 PIECE

Art.501 **C CLAMP**

 Dispositivo di bloccaggio su tavolo con piano fino a 50 mm di spessore. Adatto per morsetti con asta da \varnothing 8 a 10 mm (3/8").

 C clamp suitable for any table top up to 50 mm thick. Fits on vises with stem 8-10 mm \varnothing (3/8").

 Dispositif de fixation sur tables de 50 mm d'épaisseur max. Utilisable sur étaux avec tige de \varnothing 8 à 10 mm (3/8").





CONFEZIONE DA 1 PEZZO
PACK SIZE 1 PIECE

Art.613 **SUPPORTO ELITE**

ELITE SUPPORT
SUPPORT ELITE

 Accessorio in acciaio inox applicabile su morsetti con asta da 8 a 10 mm. Posizionamento completamente regolabile. Adatto sia come attacco "parachute" che come supporto bobinatore. Il suo design tondeggiante lascia ampio spazio per lavorare.

 Stainless steel tool adjustable in every direction. Fits all vises with stem from 8 to 10 mm. This tool is designed to be used as a "parachute" attachment or a bobbin rest. Its rounded shape provides ample room to work.

 Bras en acier inox complètement réglable et utilisable sur étaux avec tige de 8 à 10 mm. Cet accessoire peut être utilisé pour le montage de mouches "parachute" ou comme support repose-bobine. Sa forme arrondie laisse beaucoup d'espace pour travailler.

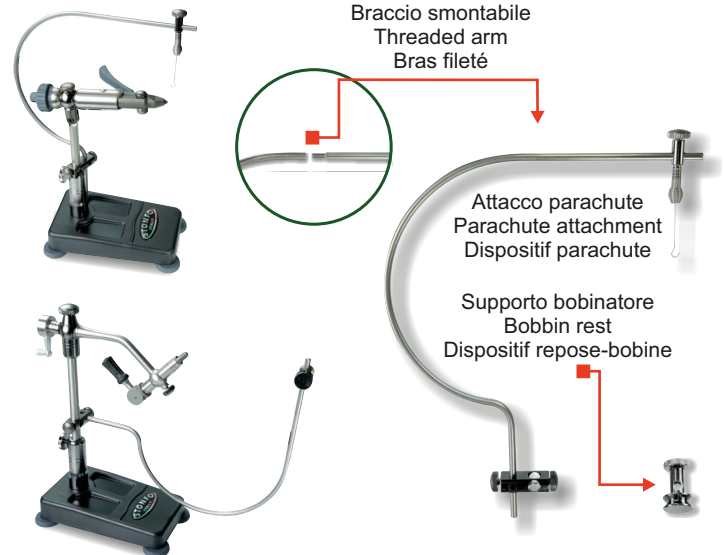

Braccio smontabile
Threaded arm
Bras fileté

Attacco parachute
Parachute attachment
Dispositif parachute

Supporto bobinatore
Bobbin rest
Dispositif repose-bobine

CONFEZIONE DA 1 PEZZO - PACK SIZE 1 PIECE

Art.480 **SUPPORTO BOBINATORE** BOBBIN REST

 Supporto per bobinatore con braccio lungo in acciaio inox. Completamente regolabile é applicabile su morsetti con asta di Ø 8-10 mm.

 Bobbin rest with stainless steel long arm. Adjustable in every direction. Fits on vises with stem 8-10 mm Ø.

 Support repose-bobine avec long bras en acier inox complètement réglable. Utilisable sur étaux avec tige de Ø 8 à 10 mm.

CONFEZIONE DA 1 PEZZO
PACK SIZE 1 PIECE

Art.481 **SUPPORTO PARACHUTE** PARACHUTE ATTACHMENT

 Accessorio in acciaio inox completamente regolabile per il montaggio di mosche "parachute". Applicabile su morsetti con asta di Ø 8-10 mm.

 Stainless steel "parachute" rest. Adjustable in every direction. Fits on vises with stem 8-10 mm Ø.

 Bras en acier inox complètement réglable pour le montage de mouches "parachute". Utilisable sur étaux avec tige de Ø 8 à 10 mm.

CONFEZIONE DA 1 PEZZO
PACK SIZE 1 PIECE

Art.482 **PINZETTA PARACHUTE** PARACHUTE PLIER

 Pinza indispensabile per il montaggio di mosche "parachute". Applicabile su asta di Ø 5 mm.

 Useful plier for the tying of "parachute" flies. Suitable for stem 5 mm Ø.

 Pince très utile pour le montage de mouches "parachute". Utilisable avec tige de Ø 5 mm.

CONFEZIONE DA 1 PEZZO - PACK SIZE 1 PIECE

Art.483 **SPIRALE DI BLOCCAGGIO** SPRING MATERIAL CLIP

 Spirale in acciaio inox utilissima per bloccare filo ed altro materiale di montaggio sul morsetto.

 Stainless steel spring to clip threads or other tying materials on the vise.

 Ressort en acier inox pour fixer les fils ou autres matériaux sur l'étau.

CONFEZIONE DA 1 PEZZO - PACK SIZE 1 PIECE

Art.692 **TOOL BAR**

 Pratica e funzionale barretta porta attrezzi fornita di una boccia di riduzione che ne consente l'applicazione su morsetti con asta da Ø 8 a 10 mm (3/8"). Realizzata in alluminio anodizzato ha una serie di 15 fori di varia forma, dimensione e angolazione, che permettono il posizionamento della maggior parte degli attrezzi esistenti.

 Practical and functional tool holder supplied with adaptor bush to fit on vise stems from 8 to 10 mm (3/8"). Made of anodized aluminum has a series of 15 holes of different shape, size and angle, that allow the positioning of the majority of existing tools.

 Pratique et fonctionnelle barre porte outils livré avec bague de réduction pour étaux avec tige de 8 à 10 mm (3/8"). Réalisée en aluminium anodisé, elle a une série de 15 trous de différente forme, taille et angle, qui permettent le positionnement de la plupart des outils existants.

CONFEZIONE DA 1 PEZZO - PACK SIZE 1 PIECE

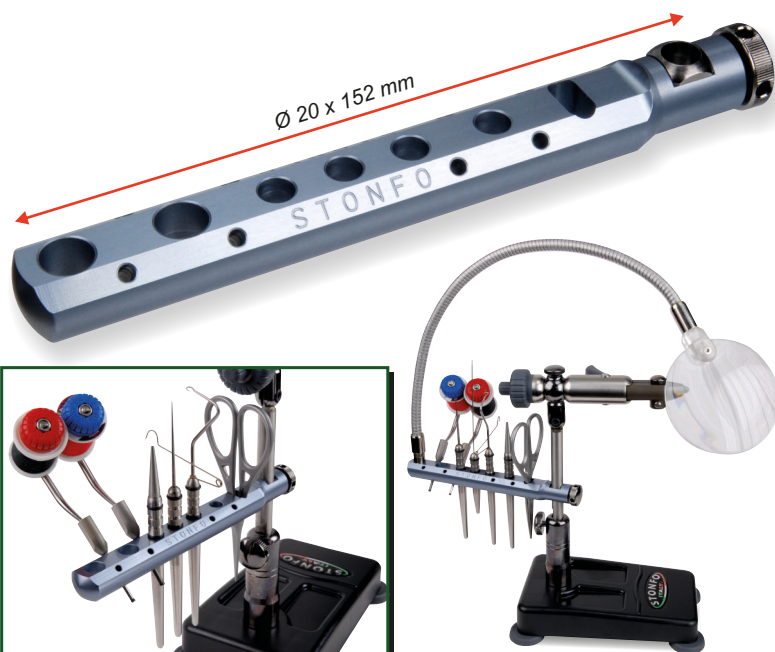

Art.626 **JOINT BLOCK**

 Blocchetto snodato per morsetto. Permette di bloccare fino a quattro accessori contemporaneamente. Adatto per morsetti con stelo da 8 mm a 10 mm (3/8"). Fornito con boccia di riduzione per stelo da 8 mm e chiave a brugola.

 Joint block. It clamps to the vise allowing the positioning of up to four accessories at the same time. Fits on vise stems from 8 mm to 10 mm (3/8"). Supplied with 8 mm adaptor bush and allen key.

 Bloque accessoires pour étau. Il permet de positionner jusqu'à quatre accessoires en même temps. Utilisable sur étaux avec tige de 8 à 10 mm (3/8"). Livré avec bague de réduction pour tige de 8 mm et clé allen.

CONFEZIONE DA 1 PEZZO - PACK SIZE 1 PIECE

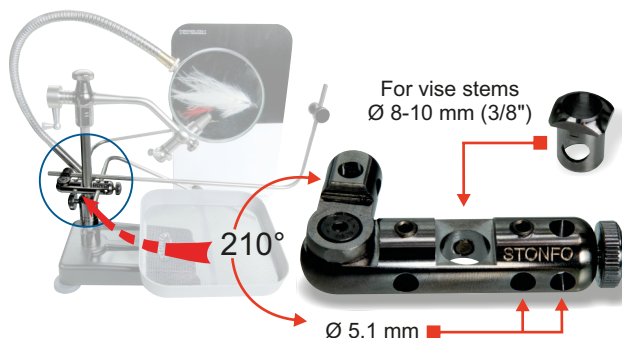

Art.614 VASCHETTA RACCOGLI SPORCO

WASTE BIN dim. 15X15 cm

 Vaschetta raccogli-sporco con fondo a rete antistatica, si fissa all'asta del morsetto tramite un supporto inox che ne consente una precisa regolazione della posizione. Occupa poco spazio in altezza e si toglie in un attimo grazie allo speciale attacco magnetico. Applicabile su morsetti con asta da 8 a 10 mm.

 Waste bin with antistatic mesh bottom, fully adjustable on the vise stem. The waste bin can be immediately pulled off thanks to its magnetic attachment. Compact in height. Arm in stainless steel. Fits on vises with stem from 8 to 10 mm.

 Poubelle avec le fond en filet antistatique, se fixe à l'étau par un support inox complètement réglable. Livré avec fixation magnétique qui permet de la vider en un instant. Elle est compacte en hauteur. Utilisable sur étaux avec tige de 8 à 10 mm.





Attacco magnetico
Magnetic attachment
Fixation magnétique

CONFEZIONE DA 1 PEZZO
PACK SIZE 1 PIECE

Art.542 SCHERMO PER MORSETTO

PROFILE PLATE FOR VISE

 Schermo di contrasto a doppio colore bianco e nero per agevolare ogni situazione di montaggio. Fornito completo di attacco magnetico che permette la rotazione dello schermo per un immediato cambio di sfondo. Superficie non riflettente. Adatto per morsetti con asta da \varnothing 8 a 10 mm.

 Swivel profile plate for vise. Double colour black and white for your tying needs. Equipped with magnetic rest device that allows the rotation of the plate for a quick colour change. Non reflective surface. Fits on vises with stem 8-10 mm \varnothing .

 Écran de contraste pour étau à double couleur noir et blanc pour faciliter votre travail. Livré avec fixation magnétique qui permet une rotation du écran pour un immédiat changement de couleur. Surface non réfléchissante. Utilisable sur étaux avec tige de \varnothing 8 à 10 mm.

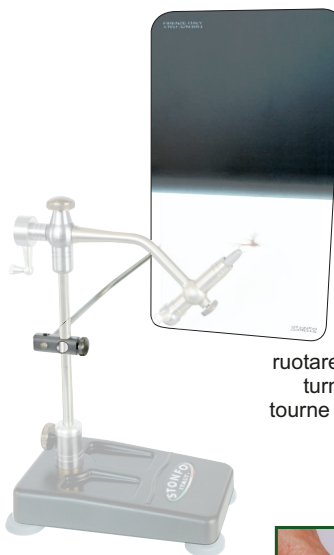



ruotare per cambiare colore
turn to change colour
tourne pour changer couleur

CONFEZIONE DA 1 PEZZO
PACK SIZE 1 PIECE

Art.661 DUBBING BRUSH DEVICE

 Accessorio per morsetti rotanti, permette la realizzazione di dubbing brushes di 23 cm di lunghezza max. La tavoletta di lavoro, stabile e regolabile in altezza, consente una facile disposizione dei più svariati materiali. Un'apposita nicchia agevola un preciso taglio degli stessi alla lunghezza desiderata.

 Accessory for rotary vises, specially designed to make dubbing brushes of 23 cm max. The table, steady and with adjustable height, allows to apply easily various types of material on the metallic wire. A special niche facilitate a precise cut of these materials to the desired length.

 Accessoire pour étaux rotatifs, permet la réalisation des dubbing brushes de 23 cm de longueur max. La tablette de travail, stable et réglable en hauteur, permet un facile positionnement des divers types de matériau. Une spéciale niche facilite une coupe précise des ces matériaux à la longueur désirée.



morsetto non incluso
vice not included
etau pas inclus

CONFEZIONE DA 1 PEZZO - PACK SIZE 1 PIECE



Nicchia graduata per agevolare il taglio
Graduated niche to facilitate the cut
Niche graduée pour faciliter la coupe



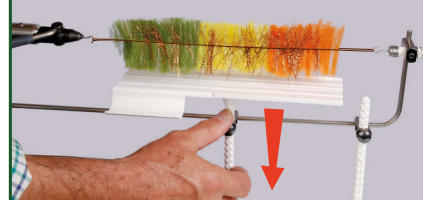

Tavoletta con scanalature
Table with grooves - Tablette avec rainures



Tavoletta regolabile in altezza.
Adjustable height table
Tablette réglable en hauteur

Art.684 TURBO SPIN

 Il Turbo Spin è un accessorio che serrato nelle pinze di un qualsiasi tipo di morsetto permette, grazie ad un cuscinetto di precisione, una rotazione controllata ideale per la realizzazione di dubbing brushes. Perfetto complemento al Dubbing Brush Device art.661.

 The Turbo Spin is an accessory that placed in the jaws of any type of vise allows, thanks to a precision ball bearing, an ideal rotation to create dubbing brushes. Perfect complement to the Dubbing Brush Device item 661.

 Le Turbo Spin est un accessoire qui bloqué dans les mors de n'importe quel type d'étau permet, grâce à un roulement à billes de précision, une rotation idéale pour la réalisation de dubbing brushes. Parfait complément au Dubbing Brush Device art. 661.



CONFEZIONE DA 1 PEZZO - PACK SIZE 1 PIECE

Art.630 **LENTE PER MORSETTO** MAGNIFYING GLASS FOR VISE



Lente d'ingrandimento appositamente studiata per l'utilizzo su morsetti, consente di vedere chiaramente e senza distorsioni piccoli particolari durante il montaggio, senza impegnare le mani. E' munita di braccio flessibile regolabile in ogni posizione con all'estremità un attacco di piccole dimensioni che permette un facile e stabile bloccaggio su morsetti con asta da Ø 8 a 10 mm (3/8") e su aste porta-accessori di Ø 5 mm. Dati tecnici: ingrandimento 2X, dimensioni lente 80 mm, lunghezza braccio flessibile 350 mm, peso gr 170. Non è adatta per l'incastro sul porta-utensili integrato della BASE TRR (art. 657).



Magnifying glass specially designed for fitting on vises, allows to clearly see without distortions small details during the tying. It has a flexible arm fully adjustable to any position with a small attachment that permits an easy and stable locking on vise stems from Ø 8 to 10 mm (3/8") and on accessory stems of Ø 5 mm. Technical data: 2X magnification, lens dimensions 80 mm, length flexible arm 350 mm, weight 170 gr. It can't be attached on the integrated tool rack of TRR BASE (art. 657).



Loupe spécialement conçue pour une utilisation sur les étaux, vous permet de voir clairement et sans distorsions petits détails lors de montage, sans utiliser les mains. Elle est équipée d'un bras flexible, complètement réglable, avec un petit dispositif de fixation qui permet un blocage facile et stable sur les étaux avec tige de Ø 8 à 10 mm (3/8") et tiges porte-accessoires de Ø 5 mm. Données techniques: grossissement par 2, dimensions loupe 80 mm, bras flexible de 350 mm long, poids gr 170. Elle n'est pas apte pour la jonction sur le porte-outils intégré du TRR BASE (art. 657).

CONFEZIONE DA 1 PEZZO - PACK SIZE 1 PIECE



Attachment on stems
Attacco su aste
Ø 5 - 8 - 10 mm
Ø 3/8"

Art.642 **LENTE A VENTOSA** MAGNIFYING GLASS WITH SUCTION CUP BASE



Lente d'ingrandimento di alta qualità, consente di vedere chiaramente e senza distorsioni piccoli particolari. Il braccio flessibile ha una potente base a ventosa con azionamento a leva per garantire un rapido e sicuro bloccaggio. Rimuovendo la ventosa, questa lente si incastra perfettamente nel porta-utensili integrato della BASE TRR (art. 657). Dati tecnici: ingrandimento 2X, dimensioni lente 80 mm, lunghezza braccio flessibile 350 mm, peso gr 165.



High quality magnifying glass, allows to clearly see small details without distortions. The flexible arm has a powerful suction cup base with lever device to guarantee a quick and stable locking. Removing the suction cup, this magnifying glass can be attached easily on the integrated tool rack of the TRR BASE (art. 657). Technical data: 2X magnification, lens dimensions 80 mm, length flexible arm 350 mm, weight 165 gr



Loupe d'haute qualité, vous permet de voir clairement et sans distorsions petits détails. Le bras flexible est équipé d'une puissante base à ventouse avec dispositif à levier pour garantir un blocage rapide et stable. En enlevant la ventouse, cette loupe peut être attachée facilement sur le porte-outils intégré du TRR BASE (art. 657). Données techniques: grossissement par 2, dimensions loupe 80 mm, bras flexible de 350 mm long, poids gr 165.

CONFEZIONE DA 1 PEZZO - PACK SIZE 1 PIECE



Art.711 **TRAVEL TOOL SET** NEW 2020



Set da viaggio completo di 8 utensili per la costruzione di mosche artificiali e streamers. Fornito in una robusta ed elegante scatola in cui interno in gomma è sagomato per dare ad ogni utensile un preciso alloggiamento. Il set comprende: Forbicine, bobinatore Bobtec1 con tensionamento del filo regolabile, Passafilo, Annodatore-Annodatore conico, Spillo di montaggio, Pinza per hackles, Rotodubbing mini, Pettine Comb. All'interno dettagliate istruzioni per l'uso dei vari utensili.



Complete travel set which includes 8 fly tying tools. Supplied in a strong and elegant case whose rubber interior is shaped to give each tool a precise housing. The set includes: small Scissor, Bobtec1 bobbin with adjustable thread tension, Bobbin threader, Finisher-Conical finisher, Bodkin, Hackle pliers, Rotodubbing mini, Pettine comb. Inside detailed instructions of the various tools.



Set de voyage complet de 8 outils pour le montage de mouches et streamers. Livré dans une boîte robuste et élégante avec l'intérieur en mousse découpée pour donner à chaque outil un logement précis. Le set comprend: petits Ciseaux, porte-bobine Bobtec1 avec curseur pour régler la tension du fil, Passe-fil, Finisseur-Finisseur conique, Aiguille à dubbing, Pince à Hackles, Rotodubbing mini, Pettine Comb. Instructions détaillées à l'intérieur pour l'utilisation des différents outils.



LEGERISSIMO
ULTRA-LIGHT
ULTRA-LÉGER Gr 200

CONFEZIONE DA 1 PEZZO - PACK SIZE 1 PIECE

Art.446 **PASSAFILO 1** BOBBIN THREADER TYPE 1



Utensile per agevolare il passaggio del filo nel tubetto del bobinatore. La sua impugnatura anatomica con parte esagonale in gomma soft touch ne impedisce la rotazione sul banco di lavoro. Fornito con istruzioni per l'uso.



Useful tool to thread the bobbin holder. The soft touch handle has a special hexagonal shape so that the tool won't roll off the tying table. Instructions included.





Passe-fil pour retirer le fil du tube du porte bobine avec poignée anatomique soft touch. Sa forme hexagonale limite la rotation sur la table de travail. Livré avec notice d'emploi.



BUSTA DA 1 PEZZO - CONFEZIONE DA 10 BUSTE
1 PIECE PER BAG - PACK SIZE 10 BAGS

Art.447 **PASSAFILO 2** BOBBIN THREADER TYPE 2

 Utensile per agevolare il passaggio del filo nel tubetto del bobinatore. La sua impugnatura anatomica con parte esagonale in gomma soft touch ne impedisce la rotazione sul banco di lavoro. Fornito con istruzioni per l'uso.

 Useful tool to thread the bobbin holder. The soft touch handle has a special hexagonal shape so that the tool won't roll off the tying table. Instructions included.

 Passe-fil pour retirer le fil du tube du porte bobine avec poignée anatomique soft touch. Sa forme hexagonal limite la rotation sur la table de travail. Livré avec notice d'emploi.



BUSTA DA 1 PEZZO - CONFEZIONE DA 10 BUSTE
1 PIECE PER BAG - PACK SIZE 10 BAGS

BOBINATORI BOBBIN AND MAXI BOBBIN

 Bobinatori di alta qualità adatti per ogni tipo di bobina. Tubetto di acciaio inox munito di speciali boccole anti-usura del filo. Per facilitare il passaggio del filo dentro il tubetto consigliamo l'uso degli appositi Passafilo Stonfo.

 High quality bobbin holders for every size spools. Stainless steel tube with special bushes to prevent fraying. We recommend the Stonfo Threaders to thread the Bobbins easily.

 Porte-bobines d'haute qualité pour bobines de toutes les grandeurs. Munis de tube inox avec embouts spéciaux glisse-fil. Pour enfiler plus facilement le fil dans le tube nous conseillons d'utiliser les Passe-Fil Stonfo.

BUSTA DA 1 PEZZO - CONFEZIONE DA 10 BUSTE * 1 PIECE PER BAG - PACK SIZE 10 BAGS

BOBINATORE

Art.438

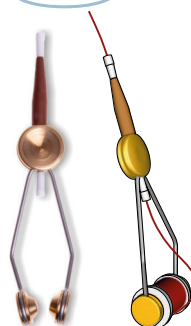

Art.457

BOBINATORE MAXI

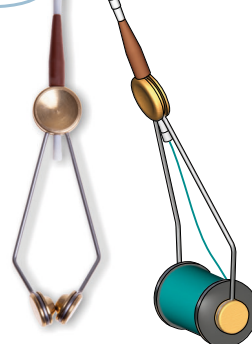

Art.503 **PINZA HACKLES STANDARD**

STANDARD HACKLES PLIER

 Pinza per l'avvolgimento della piuma con impugnatura anulare in gomma soft touch.

 Hackle plier with ring-shaped soft touch handle.

 Pince à hackles pour travailler la plume avec poignée annulaire soft touch.



BUSTA DA 1 PEZZO - CONFEZIONE DA 10 BUSTE
1 PIECE PER BAG - PACK SIZE 10 BAGS

Art.462 **PINZE PER HACKLES** HACKLE PLIERS - PINCES À HACKLES

 Pinze rotanti che permettono di velocizzare al massimo l'avvolgimento della piuma. La molla in acciaio inox funzionando da ammortizzatore durante la fase di avvolgimento impedisce le frequenti e fastidiose rotture della piuma. Due le misure disponibili con molla corta e lunga.

 Revolving hackle pliers enables a continuous winding of the hackle at maximum speed. The shock-absorber spring prevent the frequent breakages of the hackle. Available in two different models with short and long spring.

 Pincés à hackles rotatives pour travailler la plume rapidement. Le ressort amortisseur évite le problème de la rupture de la plume. Disponible en deux modèles avec ressort court et long.

MIS. 1
Short spring





MIS. 2
Long spring



BUSTA DA 1 PEZZO - CONFEZIONE DA 10 BUSTE
1 PIECE PER BAG - PACK SIZE 10 BAGS

Art.442 **ANNODATORE** FINISHER

 Annodatore di alta qualità con impugnatura anatomica soft touch. Fornito con istruzioni per l'uso.

 High quality whip finisher tool for tying knots at the head of any size fly. Soft touch handle. Instructions included.

 Finisseur de nœuds d'haute qualité avec poignée anatomique soft touch. Livré avec notice d'emploi.

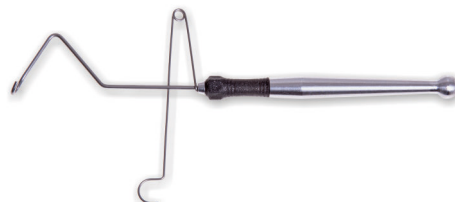

BUSTA DA 1 PEZZO - CONFEZIONE DA 10 BUSTE
1 PIECE PER BAG - PACK SIZE 10 BAGS

Art.441 **SET ANNODATORE CONICO** CONICAL FINISHER

 Annodatore conico per realizzare il nodo di chiusura della mosca, è fornito con 3 punte intercambiabili di Ø mm 1,5 -2,2 -3,0. Fornito con istruzioni per l'uso.

 Conical finisher with 3 different heads of Ø mm 1,5 -2,2 -3,0. Instructions included.

 Finisseur de nœuds conique avec 3 pointes de Ø mm 1,5 -2,2 -3,0. Livré avec notice d'emploi.



BUSTA DA 1 PEZZO - CONFEZIONE DA 10 BUSTE
1 PIECE PER BAG - PACK SIZE 10 BAGS

Art.445 **SPILLO DI MONTAGGIO** BODKIN

 Spillo di montaggio per artificiali. La sua impugnatura anatomica con parte esagonale in gomma soft touch ne impedisce la rotazione sul banco di lavoro.

 Very useful tool for fly tying. The soft touch handle has a special hexagonal shape so that the tool won't roll off the tying table.

 Aiguille pour le montage des mouches avec poignée anatomique soft touch. Sa forme hexagonal limite la rotation sur la table de travail.



BUSTA DA 1 PEZZO - CONFEZIONE DA 10 BUSTE
1 PIECE PER BAG - PACK SIZE 10 BAGS

Art.443 **DUBBING 1**

 Utensile avvolgipelo di alta qualità. Impugnatura anatomica con parte esagonale in gomma soft touch. Fornito con istruzioni per l'uso.

 High quality dubbing tool with soft touch handle. Instructions included.

 Enrouler à dubbing d'haute qualité avec poignée anatomique soft touch. Livré avec notice d'emploi.



BUSTA DA 1 PEZZO - CONFEZIONE DA 10 BUSTE
1 PIECE PER BAG - PACK SIZE 10 BAGS

Art.444 **DUBBING 2**

 Utensile avvolgipelo di alta qualità. Impugnatura anatomica con parte esagonale in gomma soft touch. Fornito con istruzioni per l'uso.

 High quality dubbing tool with soft touch handle. Instructions included.

 Enrouler à dubbing d'haute qualité avec poignée anatomique soft touch. Livré avec notice d'emploi.



BUSTA DA 1 PEZZO - CONFEZIONE DA 10 BUSTE
1 PIECE PER BAG - PACK SIZE 10 BAGS

Art.439 **ROTODUBBING 1**

 Utensile avvolgipelo rotante di alta qualità con cuscinetto interno. Studiato per agevolare il montaggio di corpi in dubbing. Fornito con istruzioni per l'uso.

 High quality revolving dubbing tool with ball bearing inside. Instructions included.

 Enrouler à dubbing d'haute qualité avec roulement à billes. Livré avec notice d'emploi.



BUSTA DA 1 PEZZO - CONFEZIONE DA 10 BUSTE
1 PIECE PER BAG - PACK SIZE 10 BAGS

Art.440 **ROTODUBBING 2**

 Utensile avvolgipelo rotante di alta qualità con cuscinetto interno. Studiato per agevolare il montaggio di corpi in dubbing. Fornito con istruzioni per l'uso.

 High quality revolving dubbing tool with ball bearing inside. Instructions included.

 Enrouler à dubbing d'haute qualité avec roulement à billes. Livré avec notice d'emploi.

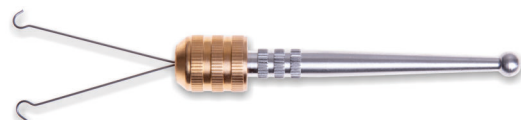

BUSTA DA 1 PEZZO - CONFEZIONE DA 10 BUSTE
1 PIECE PER BAG - PACK SIZE 10 BAGS

Art.469 **DUBBING TWISTER**

 Utensile avvolgipelo rotante di piccole dimensioni. Studiato per agevolare il montaggio di corpi in dubbing. Fornito con istruzioni per l'uso.

 High quality revolving dubbing tool. Very small dimensions. Instructions included.

 Enrouler à dubbing d'haute qualité et de petite taille. Livré avec notice d'emploi.



BUSTA DA 1 PEZZO - CONFEZIONE DA 10 BUSTE
1 PIECE PER BAG - PACK SIZE 10 BAGS

Art.704 **ROTODUBBING MINI**

 Utensile per dubbing di dimensioni ridotte. È munito di cuscinetto interno e di uno speciale manico ergonomico a forma di anello.

 Very small dubbing tool. It's equipped with an internal ball bearing and a special ring-shaped ergonomic handle.

 Outil à dubbing de petite taille. Il est équipé d'un roulement à billes interne et d'une poignée ergonomique spéciale en forme d'anneau.



BUSTA DA 1 PEZZO - CONFEZIONE DA 10 BUSTE
1 PER BAG - PACK SIZE 10 BAGS

Art.470 **PAREGGIAPELO**

HAIR STACKER

 Pareggia pelo con fondo in gomma antirumore. I due coni di diversa grandezza permettono un perfetto allineamento di qualsiasi tipo di pelo.

 Hair stacker with rubber bottom. Aligns perfectly any type of hair. Supplied with two different sized cones.

 Aligner poil avec fond en caoutchouc. Muni de deux cônes de différente taille pour aligner correctement les poils traités.



BUSTA DA 1 PEZZO - CONFEZIONE DA 10 BUSTE
1 PIECE PER BAG - PACK SIZE 10 BAGS

Art.695 **PAREGGIAPELO MINI** MINI HAIR STACKER

 Realizzato in metallo con fondo in gomma, consente un allineamento perfetto di piccole quantità di pelo e di fibre di ogni genere per la realizzazione di code o ciuffetti vari.

 Produced in metal with rubber bottom, allows a perfect alignment of small quantities of hair and fibers for the realization of tails or tufts.

 Réalisé en métal avec fond en caoutchouc, il permet un alignement parfait de petites quantités de poil et fibres pour la réalisation de queues ou touffes.

BUSTA DA 1 PEZZO - CONFEZIONE DA 10 BUSTE * 1 PIECE PER BAG - PACK SIZE 10 BAGS



Art.651 **HAIR PACKER**

 Questo semplice accessorio rende più facile le operazioni di montaggio di mosche, streamers, poppers ed altro compattando il pelo sia naturale che sintetico. Le due testine di diversa grandezza sono munite al loro interno di un cilindretto elastico per accogliere ami di qualsiasi dimensione. Fornito di due cilindretti elastici di ricambio.

 This simple accessory facilitates the tying operation of flies, streamers, poppers and other lures, compacting the hair both natural and synthetic. The two different size heads are equipped inside with an elastic cylinder to accommodate hooks of any size. Supplied with two spare elastic cylinders.

 Cet simple accessoire facilite les opérations de montage de mouches, streamers, poppers et autres leurres, en compactant le poil naturel ou synthétique. Les deux têtes de taille différente sont munies à l'intérieur d'un cylindre élastique pour loger hameçons de toutes les tailles. Livré avec deux cylindres élastiques de rechange.

BUSTA DA 1 PEZZO - CONFEZIONE DA 10 BUSTE
1 PIECE PER BAG - PACK SIZE 10 BAGS

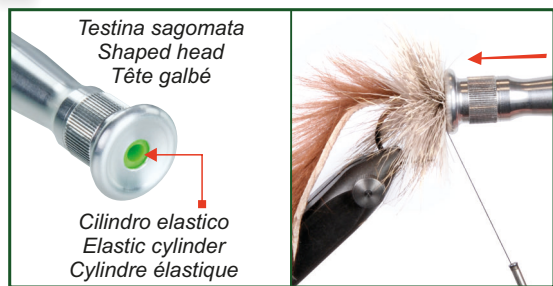

Art.645 **PETTINE COMB**

 Il Pettine Comb realizzato con materiale plastico ad alta resistenza comprende nel suo insieme un piccolo pettine a denti fitti ed una spazzolina in velcro. Ideale per dare una finitura maggiore agli artificiali e per renderli più vaporosi e adescanti.

 The Pettine Comb realised with high resistance plastic material, is composed of a small narrow-toothed comb and a velcro brush. Ideal to improve the finishing of your lures and to make them more fluffy and attractive.

 Le Pettine Comb réalisé en matériau plastique à haute résistance, est composé d'un petit peigne fin et une brosse en velcro. Idéal pour le finissage des leurres pour les rendre plus vaporeux et attractifs.



BUSTA DA 1 PEZZO - CONF. DA 10 BUSTE
1 PIECE PER BAG - PACK SIZE 10 BAGS

Art.696 **COCCODRILLO**

 Utensile che permette la realizzazione di dubbing composti utilizzando spezzoni di vario materiale tipo ciniglia, lunghe hackles, tinsel e altro. Questi materiali vengono bloccati insieme grazie alla pinza, ed avvolti contemporaneamente tramite un volantino montato su cuscinetto creando così cordoncini nelle fantasie più singolari. La sua testa è basculante a 180 gradi con blocco in posizione centrale. Posizionando la testa a 90 gradi si evita lo srotolamento del dubbing il quale può essere poi avvolto agevolmente sull'amo.

 Tool that allows to make composite dubbings using sections of various materials like chenille, long hackles, tinsel, etc. These materials can be locked together by the plier, and wrapped at the same time turning the handwheel mounted on a bearing, in order to create multicolored dubbing noodles. Its swinging head permits 180 degrees of free swinging motion with block at center position. The positioning of the head at 90 degrees prevents unrolling of the dubbing that can be wrapped easily on the hook.

 Outil qui permet la réalisation de dubbing composites en utilisant matériaux de différents types comme chenille, longues hackles, tinsel, etc. Ces matériaux peuvent être bloqués grâce à la pince, et enveloppés tous ensemble en tournant le volant monté sur un roulement à billes, pour créer cordonnets multicolores. Sa tête est basculant à 180 degrés avec blocage en position centrale. Le positionnement de la tête à 90 degrés permet d'éviter le déroulement du dubbing qui peut ensuite être enroulé facilement sur l'hameçon.

BLISTER DA 1 PEZZO - CONFEZIONE DA 5 BLISTER
1 PIECE PER BLISTER - PACK SIZE 5 BLISTERS

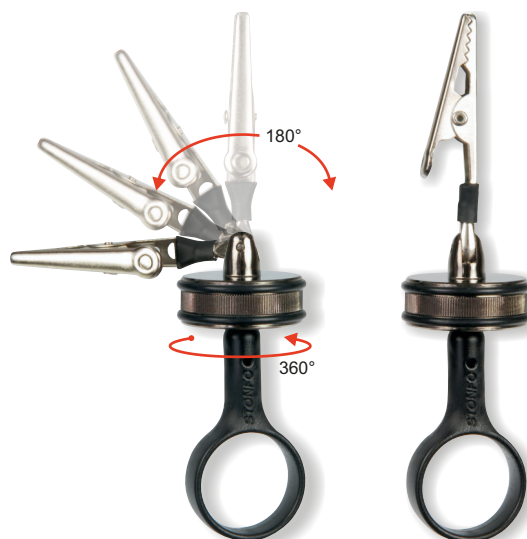

Art.708 **NIPPER STONFO**

 Taglia filo in acciaio inox munito di spillo per la pulizia dell'occhiello dell'amo. L'impugnatura ergonomica in materiale anti-scivolo ne incrementa l'efficienza.

 Stainless steel nipper equipped with hook eye cleaner. The antislip ergonomic handle improves its efficiency.

 Nipper en acier inox équipé d'une épingle pour déboucher l'œillet de l'hameçon. La poignée ergonomique en matériau antidérapant augmente son efficacité.

BUSTA DA 1 PEZZO - CONFEZIONE DA 10 BUSTE - 1 PER BAG - PACK SIZE 10 BAGS



Art.577 PINZE HACKLES ELITE ELITE HACKLE PLIERS

 Pinze per hackles di nuova concezione. Permettono di bloccare saldamente qualsiasi tipo di materiale come hackles di gallo, piume in cul de canard, microciniglie, tinsel, filo di piombo etc.etc. La misura micro è più indicata per ami piccoli 14-24, mentre la standard per ami 16-4/0.

 A new-concept hackle pliers. Permit a very good tightening of every kind of material like cock hackles, cul de canard, microchenille, tinsel, lead wire etc. etc. The micro size is suitable for small hooks 14-24, the standard size for bigger hooks 16-4/0.

 Pincés à hackles de nouvelle conception. Elles permettent de bloquer solidement nombreux matériaux comme plumes de coq, cul de canard, chenille, tinsel, fils métalliques etc.etc. La taille micro est indiquée pour hameçons petits 14-24, la taille standard pour grands hameçons 16-4/0.

BUSTA DA 1 PZ. - CONF. DA 10 BU. * 1 PIECE PER BAG - PACK SIZE 10 BAGS

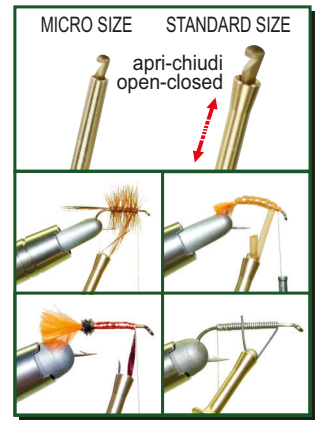

Art.528 BOBINATORE ELITE ELITE BOBBIN

 Bobinatore in acciaio inox ergonomico e curato nei particolari, munito di frizione per una precisa regolazione della tensione del filo. Il tubetto scorri-filo ha alla sua estremità una boccia in acciaio temprato resistentissima all'usura e agli urti. Adatto per bobine di varie dimensioni.

 A top quality weighted stainless steel bobbin with quick adjusting disc-drag that allows a perfect thread tension. Tube with very strong hardened steel bush to prevent fraying. Suitable for every size spool.

 Porte-bobine en acier inox ergonomique de fonctionnalité exceptionnelle, muni de un système de frein réglable pour une parfaite tension du fil. Tube glisse-fil avec tulipe en acier trempé très dur. Peut être utilisé avec tailles des bobines différentes.

BUSTA DA 1 PZ. - CONF. DA 10 BU. * 1 PIECE PER BAG - PACK SIZE 10 BAGS

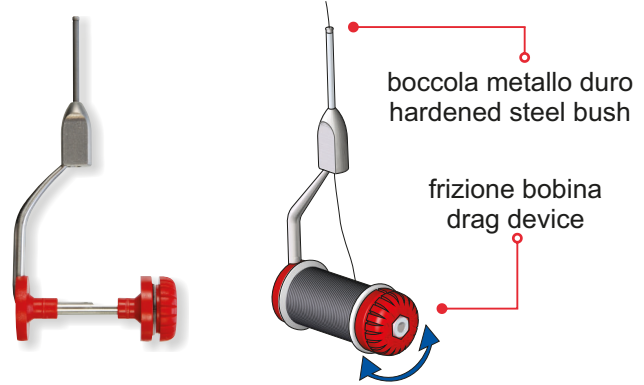

Art.579 BOBINATORE ELITE COMPACT ELITE BOBBIN COMPACT

 Bobinatore in acciaio inox di dimensioni molto contenute. Munito di frizione per una precisa regolazione della tensione del filo. Adatto per bobine di varie dimensioni.

 This stainless steel bobbin is very compact. The disc-drag allows a perfect thread tension. Suitable for every size spool.

 Porte-bobine en acier inox très compact. Il est muni de un système de frein réglable pour une parfaite tension du fil. Peut être utilisé avec tailles des bobines différentes.

BUSTA DA 1 PZ. - CONF. DA 10 BU. * 1 PIECE PER BAG - PACK SIZE 10 BAGS

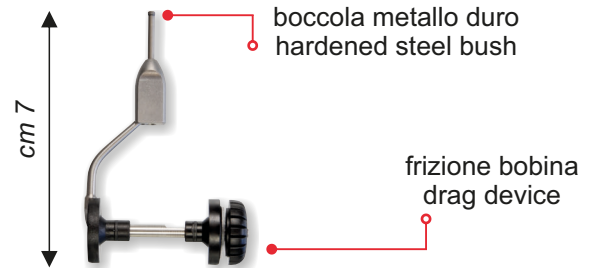

Art.578 BOBINATORE ELITE 2 ELITE BOBBIN 2

 Bobinatore in acciaio inox ideale per la costruzione di grandi artificiali e streamers. Il suo tubetto di diametro maggiorato consente l'uso di filati voluminosi come floss, microciniglie etc. Munito di frizione per una precisa regolazione della tensione del filo. Adatto per bobine di varie dimensioni.

 A top quality weighted stainless steel bobbin ideal to tie saltwater flies and streamers. The large tube allows the use of voluminous materials like floss, microchenille etc. The disc-drag permits a perfect thread tension. Suitable for every size spool.

 Porte-bobine en acier inox idéal pour monter grandes leurres et streamers. Le tube de grand diamètre permet l'emploi de matériaux volumineux comme floss, chenille etc. Il est muni de un système de frein réglable pour une parfaite tension du fil. Peut être utilisé avec tailles des bobines différentes.

BUSTA DA 1 PZ. - CONF. DA 10 BU. * 1 PIECE PER BAG - PACK SIZE 10 BAGS

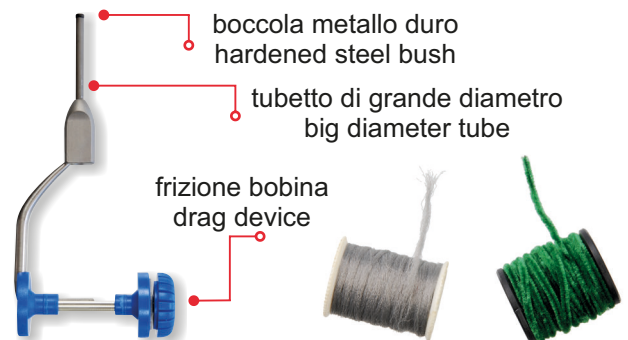

Art.674 BOBTEC1

 Bobinatore in acciaio inox con tensionamento del filo regolabile tramite cursore. Permette un cambio rapido della bobina. Il tubetto scorri-filo ha alla sua estremità una boccia in acciaio temprato resistentissima all'usura e agli urti. Perfettamente bilanciato durante la rotazione è ideale nella realizzazione di dubbing in asola creata dividendo il filo.

 Stainless steel bobbin with slider to adjust the thread tension. Allows a quick change of the spool. Perfectly balanced when rotating, is ideal to create a split thread dubbing loop. Tube with very strong hardened steel bush to prevent fraying.

 Porte-bobine en acier inox avec curseur pour régler la tension du fil. Il permet un changement rapide de la bobine. Parfaitement équilibré pendant la rotation est idéal pour le montage de dubbing en boucle réalisée en divisant le fil. Tube glisse-fil avec tulipe en acier trempé très dure.

BUSTA DA 1 PZ. - CONF. DA 10 BUSTE * 1 PIECE PER BAG - PACK SIZE 10 BAGS

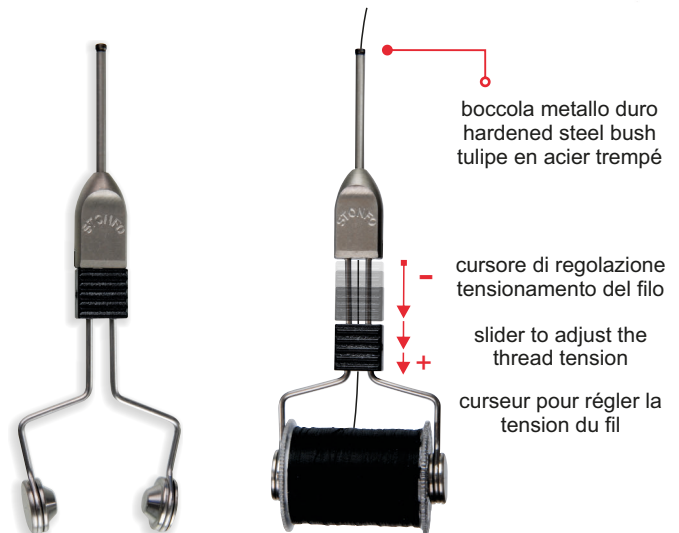

Art.675 **BOBTEC2**

 Bobinatore in acciaio inox con tubetto di diametro maggiorato indicato per filati di grande spessore. Il tensionamento del filo è regolabile tramite cursore. Permette un cambio rapido della bobina. Il tubetto scorri-filo ha alla sua estremità una boccia in acciaio temprato resistentissima all'usura e agli urti. Perfettamente bilanciato per la rotazione è ideale nella realizzazione di dubbing in asola creata dividendo il filo.

 Stainless steel bobbin with larger tube ideal for voluminous threads. Allows a quick change of the spool. Equipped with slider to adjust the thread tension. Perfectly balanced when rotating, is perfect to create a split thread dubbing loop. Tube with very strong hardened steel bush to prevent fraying.

 Porte-bobine en acier inox avec tube de grand diamètre apte pour fils volumineux. Il permet un changement rapide de la bobine. Il est muni de un curseur pour régler la tension du fil. Parfaitement équilibré pendant la rotation est idéal pour le montage de dubbing en boucle réalisée en divisant le fil. Tube glisse-fil avec tulipe en acier trempé très dure.

BUSTA DA 1 PZ. - CONF. DA 10 BUSTE * 1 PIECE PER BAG - PACK SIZE 10 BAGS

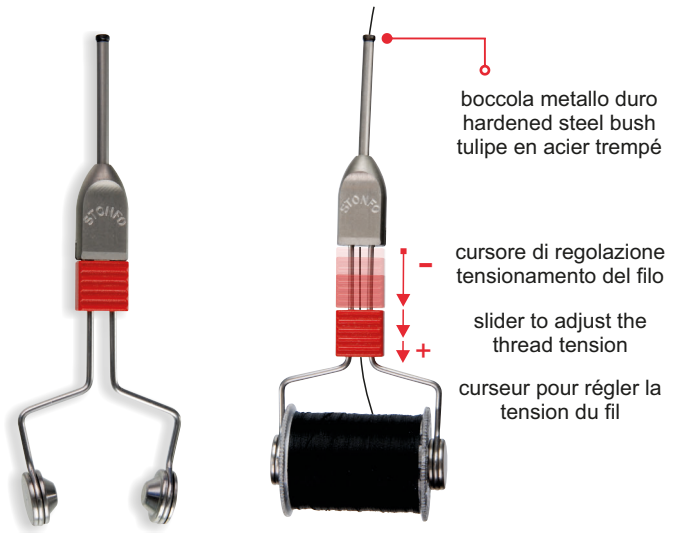

Art.707 **RAZOR STONFO**

 Rasoio speciale studiato per i costruttori di mosche e streamers, perfetto per la realizzazione di teste con pelo di cervo. La rotazione della ghiera permette di flettere la lametta fino al raggio desiderato per avere un taglio del pelo più uniforme. Fornito completo di lamette a doppio taglio.

 Special razor studied for fly and streamers tyers, perfect for the creation of deer hair heads. The rotation of the ring nut allows to flex the blade to the desired angle to have a more uniform hair cut. Supplied complete with double edge razor blades.

 Rasoir spécial étudié pour les monteurs de mouches et streamers, il est parfait pour la réalisation des têtes avec poil de cerf. La rotation de la bague permet de fléchir la lame jusqu'au rayon désiré pour avoir une coupe du poil plus uniforme. Livré avec lames à double tranchant.

BUSTA DA 1 PEZZO - CONFEZIONE DA 5 BUSTE 1 PER BAG - PACK SIZE 5 BAGS

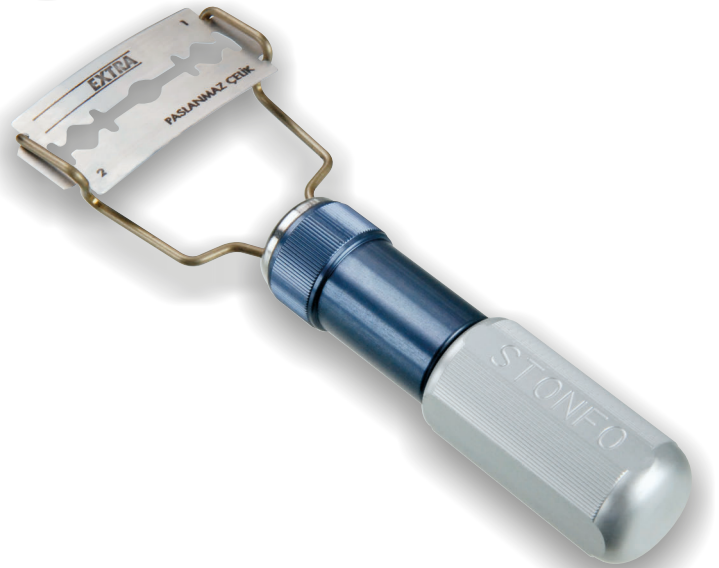

Art.709 **RAZOR BLADES**

 Lamette a doppio taglio ottime per la realizzazione di teste con pelo di cervo. Adatte per Razor Stonfo.

 Double edge razor blades perfect for the creation of deer hair heads. Suitable for Razor Stonfo.

 Lames à double tranchant parfaites pour la réalisation des têtes avec poil de cerf. Apte pour Razor Stonfo.

SCATOLINA DA 10 PEZZI - CONFEZIONE DA 10 SCATOLINE 10 PIECES PER BOX - PACK SIZE 10 BOXES



Art.586 **ANNODATORE ELITE ELITE FINISHER**

 Annodatore di eccezionale funzionalità, prodotto completamente in acciaio inox con macchinari di altissima precisione. Fornito completo di istruzioni per l'uso.

 Extra user-friendly whip finisher tool. It is produced with stainless steel material by high precision machines. Instructions included.

 Finisseur de nœuds de fonctionnalité exceptionnelle. Il est produit complètement en acier inox par des machines de haute précision. Livré avec notice d'emploi.

BUSTA DA 1 PZ. - CONF. DA 10 BU. * 1 PIECE PER BAG - PACK SIZE 10 BAGS



Art.591 ANNODATORE CONICO ELITE ELITE CONICAL FINISHER

 Annodatore conico di eccezionale funzionalità, prodotto completamente in acciaio inox con macchinari di altissima precisione. Viene fornito con tre punte intercambiabili con foro di Ø 1,4 - 2,0 - 2,7 mm e istruzioni per l'uso.

 Extra user-friendly conical finisher. It is produced with stainless steel material by high precision machines. Supplied with three different heads of Ø 1,4 - 2,0 - 2,7 mm holes. Instructions included.

 Finisseur de nœuds conique de fonctionnalité exceptionnelle. Il est produit complètement en acier inox par des machines de haute précision. Livré complet de trois pointes avec trous de mm 1,4 - 2,0 - 2,7 et notice d'emploi.

BUSTA DA 1 PEZZO - CONF. DA 10 BUSTE * 1 PIECE PER BAG - PACK SIZE 10 BAGS

Art.612 ROTODUBBING ELITE

 Utensile per dubbing di qualità superiore prodotto in acciaio inox con cuscinetto interno per una rotazione veloce e fluida. La sua testa è basculante a 180 gradi con blocco in posizione centrale. Posizionando la testa a 90 gradi si evita lo srotolamento del dubbing il quale può essere poi avvolto direttamente sull'amo senza usare pinze per hackles. Fornito completo di istruzioni per l'uso.

 Superior quality dubbing tool made of stainless steel with a ball bearing inside that allows a fast and smooth rotation. Its swinging head permits 180 degrees of free swinging motion with block at center position. The positioning of the head at 90 degrees prevents unrolling of the dubbing that can be wrapped directly on the hook without using hackle pliers. Comes with complete instructions.

 Appareil rotatif à dubbing de qualité supérieure en acier inox avec roulement à billes pour une rotation rapide et douce. Sa tête est basculant à 180 degrés avec blocage en position centrale. Le positionnement de la tête à 90 degrés permet d'éviter le déroulement du dubbing qui peut ensuite être enroulé sur l'hameçon directement sans utiliser la pince à hackle. Livré avec notice d'emploi.

BUSTA DA 1 PEZZO - CONF. DA 5 BUSTE * 1 PIECE PER BAG - PACK SIZE 5 BAGS

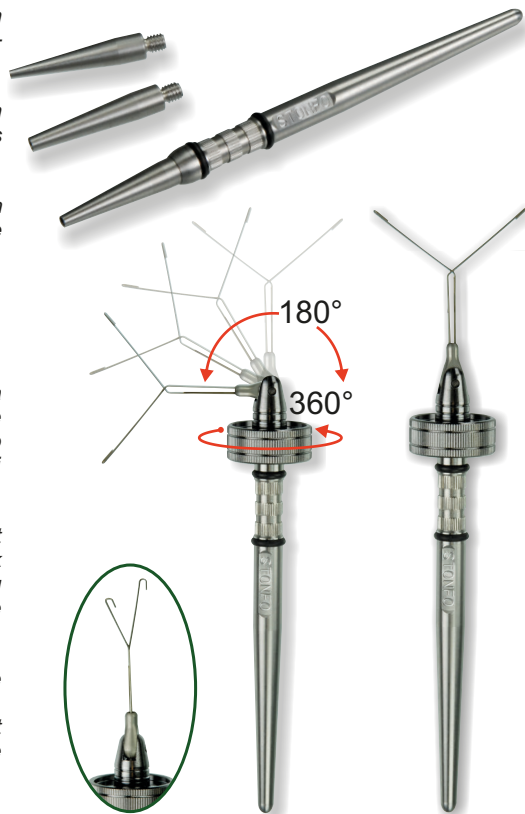

Art.639 PASSAFILO ELITE ELITE THREADER

 Passafilo di eccezionale funzionalità, agevola l'introduzione del filo nel tubetto del bobinatore. Prodotto completamente in acciaio inox con macchinari di altissima precisione è disponibile in due diverse misure. La misura 1 è adatta per bobinatori con tubetto di piccolo diametro mentre la misura 2 per bobinatori con tubetto di diametro maggiore studiati per filati voluminosi come floss, microciniglie etc.

 Extra user-friendly tool to thread the bobbin holder. It is produced with stainless steel by high precision machines and is available in 2 different sizes. Size 1 is suitable for bobbins with small tube and size 2 is suitable for bobbins with larger tube for voluminous materials like floss, microchenille, etc.

 Passe-fil très fonctionnel, pour retirer le fil du tube du porte-bobine. Il est produit complètement en acier inox par des machines de haute précision et est disponible en 2 différentes tailles. La taille 1 est conçue pour porte-bobines avec petit tube et la taille 2 est conçue pour porte-bobines avec tube plus grand étudiés pour l'emploi de matériaux volumineux comme floss, microchenille, etc.

BUSTA DA 1 PEZZO - CONF. DA 10 BUSTE * 1 PIECE PER BAG - PACK SIZE 10 BAGS

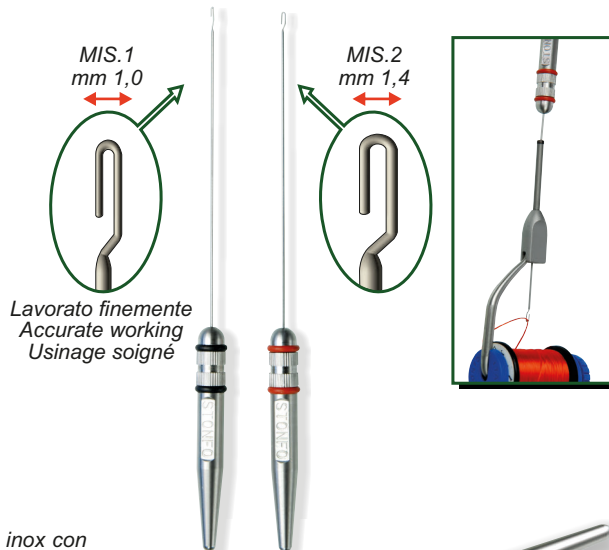

Art.590 SPILLO ELITE ELITE BODKIN

 Spillo di montaggio di eccezionale funzionalità, prodotto completamente in acciaio inox con macchinari di altissima precisione.

 Extra user-friendly bodkin. Produced with stainless steel material by high precision machines.

 Aiguille pour le montage des mouches de fonctionnalité exceptionnelle. Elle est produite complètement en acier inox par des machines de haute précision.

BUSTA DA 1 PZ. - CONF. DA 10 BU. * 1 PIECE PER BAG - PACK SIZE 10 BAGS



Art.693 SPILLO CURVO ELITE BENDED BODKIN

 Spillo in acciaio inox con caratteristica curvatura ad U. Indispensabile nell'esecuzione del dubbing in asola e dubbing brush per districare intrecci e riordinare i peli rendendo il risultato finale vaporoso ed omogeneo.

 Stainless steel bodkin with characteristic "U" shape. Indispensable in the execution of dubbing loop and dubbing brush to disentangle and pick out the fibers, giving the fly a fluffy and homogeneous profile.

 Aiguille en acier inox avec particulière courbure à U. Essentiel dans l'exécution de dubbing en boucle et de dubbing brush pour démêler et aérer les fibres en donnant à la mouche un profil vaporeux et homogène.



BUSTA DA 1 PZ. - CONF. DA 10 BUSTE
1 PIECE PER BAG - PACK SIZE 10 BAGS

Art.723

CDC FEATHERS BLOCK

Blocchetto con intagli di differente lunghezza per piegare agevolmente le piume. E' sufficiente inserire il calamo della piuma dentro l'intaglio della lunghezza appropriata. Munito di tre piedini in gomma anti-scivolo. Consigliamo di utilizzare il CDC Feathers Block in combinazione con le Pinze Dubbing Stonfo per rendere ancora più semplice la lavorazione delle piume.



Block with grooves of different length to easily fold the feathers. You just have to insert the quill of the feather inside the groove of the right length. Equipped with three antiskid rubber feet. We suggest to use the CDC Feathers Block in combination with the Hair Clips Stonfo per rendere ancora più semplice la lavorazione delle piume.



Bloc avec rainures de différentes longueurs pour plier facilement les plumes. Il est suffisant de insérer le calamus de la plume à l'intérieur de la rainure de la longueur appropriée. Équipé de trois pieds en caoutchouc antidérapants. Nous recommandons d'utiliser le CDC Feathers Block en combinaison avec les Pinces à Dubbing Stonfo pour travailler plus facilement les plumes.



BUSTA DA 1 PZ. - CONF. DA 10 BU. * 1 PIECE PER BAG - PACK SIZE 10 BAGS

Art.726

CDC WINDING TOOL

Utensile che permette di avvolgere la piuma su se stessa formando un piccolo rotolino che può essere agevolmente legato sull'amo. Ideale per la realizzazione di ali e zampe in CDC. Prodotto in acciaio inox.



Tool that allows to wind the feather on itself forming a small roll that can be easily tied on the hook. Ideal for tying CDC wings and legs. Manufactured in stainless steel.



Outil qui permet d'enrouler la plume sur elle-même en formant un petit rouleau qui peut être facilement monté sur l'hameçon. Idéal pour la réalisation des ailes et des pattes en CDC. Fabriqué en acier inox.

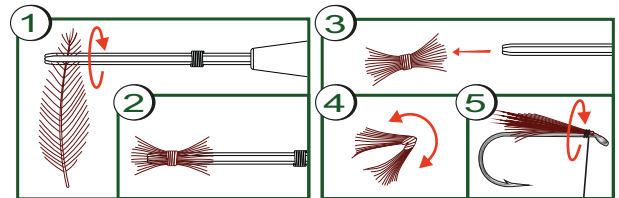

BUSTA DA 1 PZ. - CONF. DA 10 BU. * 1 PIECE PER BAG - PACK SIZE 10 BAGS

Art.725

THREAD CUTTER

Utensile munito di una speciale lama a V che consente di tagliare il filo di montaggio in modo rapido e selettivo. All'altra estremità l'utensile è munito di una corta ed acuminata punta in acciaio inox utile durante la costruzione.



Tool equipped with a special V-blade that allows to cut the thread quickly and accurately. At the other end the tool is equipped with a short and sharp needle in stainless steel useful when tying.



Outil équipé d'une lame spéciale à V qui permet de couper le fil de montage rapidement et sélectivement. À l'autre extrémité l'outil est équipé d'une pointe courte et acérée en acier inox utile pendant le montage.



BUSTA DA 1 PZ. - CONF. DA 10 BU. * 1 PIECE PER BAG - PACK SIZE 10 BAGS

Art.727

TRIMMER

Taglierino di precisione indispensabile per la finitura delle vostre mosche. All'altra estremità l'utensile è munito di una corta ed acuminata punta in acciaio inox utile durante la costruzione. Fornito di tre lame di ricambio.



Precision cutter indispensable for the finishing of your flies. At the other end the tool is equipped with a short and sharp needle in stainless steel useful when tying. Supplied with three spare blades.





Cutter de précision indispensable pour le finissage de vos mouches. À l'autre extrémité l'outil est équipé d'une pointe courte et acérée en acier inox utile pendant le montage. Livré avec trois lames de rechange.



BUSTA DA 1 PZ. - CONF. DA 10 BU. * 1 PIECE PER BAG - PACK SIZE 10 BAGS

Art.635 **THREAD SPLITTER**

 Utensile di precisione che consente di dividere filati multifibra anche sottilissimi per effettuare dubbing in asola su imitazioni di piccola dimensione. L'operazione di divisione del filo, che comporta normalmente una certa difficoltà, con questo attrezzo diviene più semplice.

 High precision tool that allows to split thin threads to make dubbing loop on small size flies. The splitting operation, very difficult to perform manually, becomes easier thanks to Thread Splitter.

 Outil de précision qui permet de diviser fils multifibre aussi très minces pour faire dubbing en boucle sur imitations de petite taille. L'opération de division du fil, qui est généralement assez difficile, avec cet outil devient plus facile.

BUSTA DA 1 PEZZO - CONF. DA 5 BUSTE
1 PIECE PER BAG - PACK SIZE 5 BAGS

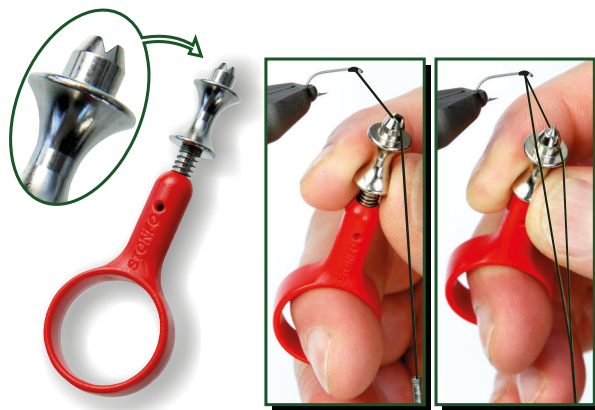

Art.634 **PINZE PER DUBBING** **HAIR CLIPS**

 Pinze indispensabili per la realizzazione di dubbing in asola utilizzando peli e piume di vario tipo. Costruite in materiale plastico trasparente ad alta resistenza e con una silhouette studiata per semplificarne l'impiego. Le superfici di chiusura hanno una leggera rugosità che consente un'ottima tenuta delle fibre. Disponibili in 3 diverse misure.

 Hair clips indispensable to make a dubbing loop using various types of hair and hackles. Made of strong clear plastic material its shape is designed to simplify the use. The locking surfaces have a slight roughness that allows perfect clamping of the fibers. Available in 3 different sizes.

 Pincettes à dubbing indispensables pour la réalisation du dubbing en boucle en employant poils et plumes de divers types. Construites en matériau plastique transparent de haute résistance et avec une silhouette conçue pour simplifier l'usage. Les surfaces de fermeture ont une légère rugosité qui permet un parfait blocage des fibres. Disponibles en 3 différentes mesures.

BUSTA DA 2 PEZZI - CONF. DA 5 BUSTE * 2 PIECES PER BAG - PACK SIZE 5 BAGS

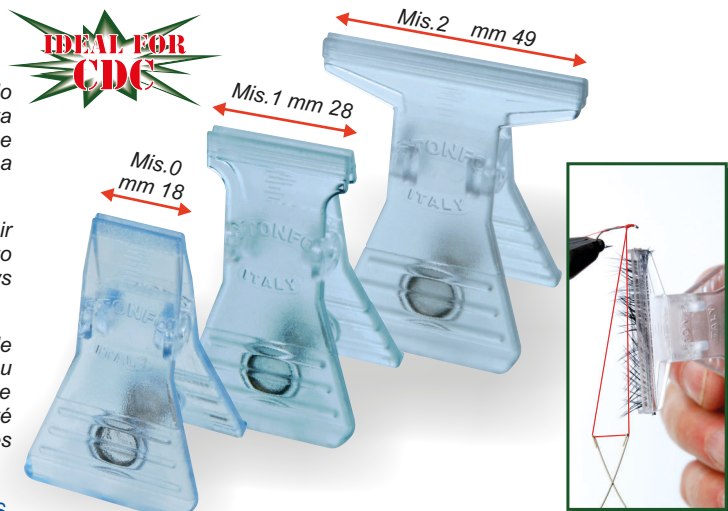

Art.648 **CREATIVE DUBBING KIT**

 Questo semplice accessorio permette la realizzazione di dubbing in varie dimensioni, sia nei diametri che nelle lunghezze. Utilizzando filati di colore diverso si possono realizzare corpi multicolore a forte impatto adescante e imitativo. Effetti particolari possono essere inoltre creati miscelando materiali di diversa tipologia come polipropilene, flashabou, cristal flash etc. etc. L'accessorio viene venduto completo di due pinze per dubbing e relative istruzioni per l'uso.

 This simple accessory allows to make dubbing of various diameters and lengths. Using yarns of different colours is possible to tie multicoloured lures with amazing attractive contrast. Special effects can be created mixing materials of different types, like polypropylene, flashabou, crystal flash, etc... Supplied with two hair clips and instructions.

 Cet simple accessoire permet la réalisation de dubbing en différents diamètres et longueurs. Utilisant multibrins de couleur différente on peut réaliser leurs multicolores les plus attrayante. Effets spéciaux peuvent être créés en mélangeant matériaux de différents types comme polypropylène, flashabou, cristal flash, etc, etc. L'accessoire est vendu avec deux pincettes à dubbing et notice d'emploi.

BLISTER DA 1 KIT - CONFEZIONE DA 5 BLISTER
1 KIT PER BLISTER PACK - PACK SIZE 5 BLISTER PACKS



Art.678 **HAIR COMPACTOR**

 Semplice ed utile accessorio studiato per riunire in un mazzetto compatto peli e fibre di piume. L'Hair Compactor è utilizzabile con pinze per dubbing di vario genere.

 Simple and useful accessory designed to bring together in a compact bunch hair and feather fibers. Hair Compactor can be used with various kinds of dubbing hair clips.

 Accessoire simple et utile conçu pour réunir dans un groupe compact poil et fibres de plumes. L'Hair Compactor peut être utilisé avec des pincettes à dubbing de types différents.

BUSTA DA 1 PZ. - CONF. DA 10 BUSTE * 1 PIECE PER BAG - PACK SIZE 10 BAGS

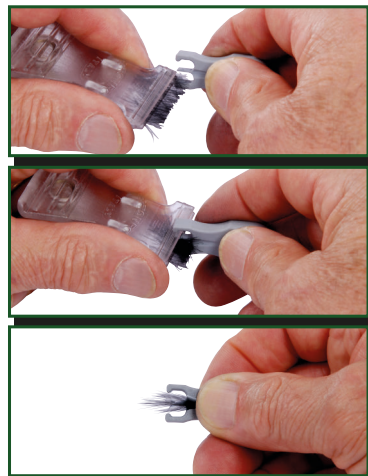
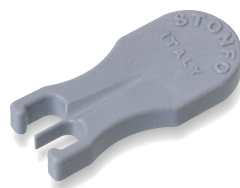

Art.650 DB TOOLS

 Il DB Tools è il prodotto ideale per la costruzione dei "detached body", esso è costituito da un micro-tubo inox con molla ferma materiale. La struttura tubolare permette l'inserimento al suo interno di un nylon di supporto per agevolare la realizzazione di corpi anche piccolissimi con materiali diversi. La confezione comprende due diverse misure.

 The DB Tools is the ideal product for tying "detached body". It is constituted by a stainless steel micro-tube with a spring material clip. The tubular structure allows to insert inside a nylon as support for the tying of very small bodies with different materials. The packaging includes two different sizes.

 Le DB Tools est la solution idéale pour le montage de "detached body". Produit en micro-tube en acier inox avec ressort fixe-fil. Sa structure tubulaire permet l'insertion à l'intérieur d'un nylon de support pour faciliter la réalisation de corps très petits avec matériaux différents. Le conditionnement comprend deux tailles différentes.

BUSTA DA 2 PEZZI - CONFEZIONE DA 10 BUSTE
2 PIECES PER BAG - PACK SIZE 10 BAGS

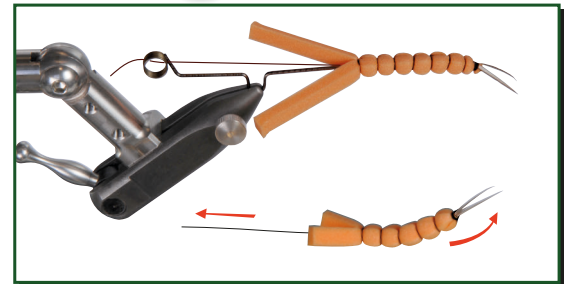
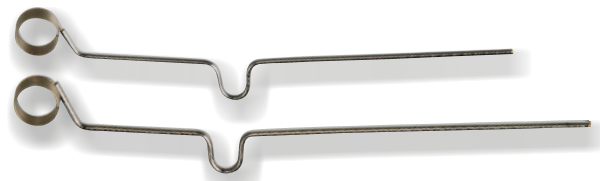

Art.488 TUBE FLY TOOL

 Questo dispositivo si blocca nella pinza del morsetto permettendo il montaggio delle tube flies con facilità. Fornito con due astine di acciaio inox di \varnothing mm 1,1 e 1,5 per una completa adattabilità a tubi di qualsiasi misura, anche quelli di grande dimensione necessari per il montaggio di esche per la pesca in mare. Fornito con istruzioni per l'uso.

 This tool can be fixed to any vise to tie tube flies easily. Supplied with two stainless steel pins 1,1 and 1,5 \varnothing mm to fit all tubes. Suitable also for sea big lures. Instructions included.

 Dispositif qui se bloque dans les mors de tous les étaux pour fixer les tube flies permettant de les monter comme des streamers normaux. Il est muni de deux tiges en acier inox de \varnothing 1,1 et 1,5 mm en fonction des tailles des tubes. Idéal aussi pour le montage de leurres pour la pêche en mer. Livré avec notice d'emploi.



BUSTA DA 1 PEZZO
1 PIECE PER BAG

Art.671 TAPERED PINS for tube-fly

 Serie completa composta da 5 spine coniche in acciaio inox finemente lavorate. Garantiscono un sicuro bloccaggio di tubetti con \varnothing interno da 0,6 mm fino a 4,0 mm per la costruzione di diversi tipi e dimensioni di tube-fly. Compatibili con i morsetti Stonfo TubeFly art.610 e Transformer art.654.

 Complete series composed of 5 stainless steel tapered pins accurately machined. They guarantee a steady locking of tubes with \varnothing int. from 0,6 mm to 4,0 mm to tie several types and sizes of tube-fly. Compatible with Stonfo vises TubeFly item 610 and Transformer item 654.

 Série complète composée de 5 tiges coniques en acier inox finement usinées. Elles garantissent un blocage sûr de tubes avec \varnothing int. de 0,6 mm à 4,0 mm pour le montage de différents types et tailles de tube-fly. Compatibles avec les étaux Stonfo Tube Fly art.610 et Transformer art.654.



SCATOLA DA 5 PEZZI - 5 PIECES PER BOX

TUBES AND CONEHEADS

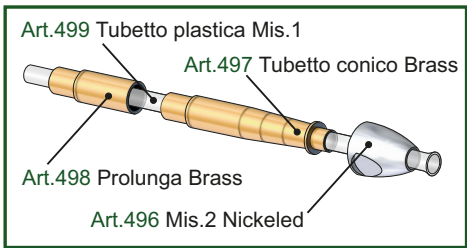

Art.499 TUBETTO PLASTICA RIGIDO TRASP.
Clear rigid plastic tube

Mis. 1
 \varnothing ext.2,1 Length 70 mm

Mis. 2
 \varnothing ext.2,6 Length 100 mm

Supplied with soft junction tube

Art.497 TUBETTO CONICO METALLO
Conic metal tube
 \varnothing ext.3,9 \varnothing int.2,2 Length 24 mm
Aluminium gr 0,4 Brass gr 1,1



Fornite di tubetto plastica interno e tubetto morbido per amo
Supplied with liner and junction tube

Art.498 PROLUNGA PER TUBETTO
Tube extension Length 12 mm
Aluminium gr 0,1 Brass gr 0,5

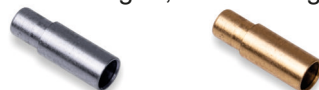

Art.495 TESTINA CONICA MICRO
Micro Conehead \varnothing ext.5 \varnothing int.2,2mm gr 0,3
Nickered
Supplied with liner and junction tube



Art.496 TESTINA CONICA
Conehead \varnothing int.2,7mm with eyes seats
Mis.1 gr 0,5
 \varnothing ext.6 mm Nickered
Mis.2 gr 0,7
 \varnothing ext.7 mm Nickered



Supplied with liner and junction tube

Art.500 TESTINA CONO PIATTO
Flat Conehead Brass \varnothing int.2,7 mm
Mis.1 \varnothing 8 mm gr 0,2
Mis.2 \varnothing 10 mm gr 0,4
Mis.3 \varnothing 12 mm gr 0,5

Supplied with liner and junction tube

Art.494 **TESTINA CLESSIDRA**

HOURGLASS HEADS



Testine in ottone nichelato con incavo per l'applicazione di occhi e fresatura centrale per agevolare il montaggio sull'amo.

Nickelated brass hourglass head with eyes seats. The central milling help to fit it on the hook.

Têtes en laiton nickelé avec logement pour les yeux et fraisage central pour aider le montage de l'hameçon.



Mis.	Ø mm	weight
1	4,0	0,4 g
2	5,5	1,0 g
3	7,5	1,8 g

BUSTA DA 10 PEZZI - CONFEZIONE DA 10 BUSTE
10 PIECES PER BAG - PACK SIZE 10 BAGS

STREAMER FISH HEADS

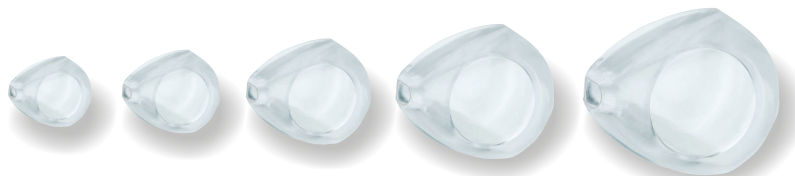

Mis.1 2 3 4 5

Art.667	Misura - Size 1 - 2	(12 pieces per bag)
Art.668	Misura - Size 3 - 4 - 5	(6 pieces per bag)



Testine studiate appositamente nella forma e nel profilo per montare streamers filanti molto realistici. Realizzate in materiale plastico trasparente, sono leggere e non influenzano il lancio. Apposite sedi ricavate lateralmente consentono l'applicazione degli occhi. Vengono prodotte in cinque diverse misure.



Heads with shape and silhouette specially designed to tie realistic streamers. Made of high resistance clear plastic material, they're lightweight and don't influence the cast. The two side sockets allow to apply the eyes. Available in 5 different sizes.



Petites têtes spécialement conçues pour monter streamers filants très réalistes. Produites en matériau plastique transparent à haute résistance, elles sont légères et n'influencent pas le lancer. Deux niches latérales permettent de placer les yeux. Disponibles en 5 tailles différentes.



CONFEZIONE DA 10 BUSTE
PACK SIZE 10 BAGS

STREAMER SOFT HEADS



Queste testine sono identiche nella forma e nelle dimensioni alle "Streamer fish heads" ma hanno la particolarità di essere realizzate in un materiale elastico e trasparente. L'elasticità del materiale consente di inserire, anche nelle misure più piccole, grossi ami aventi occhielli di diametro rilevante. Apposite sedi ricavate lateralmente consentono l'applicazione degli occhi. Prodotte in 5 diverse misure.



These small heads are identical in shape and dimensions to "Streamer fish heads" but they have the particularity of being made of a clear and elastic material. The elasticity of the material allow to insert, even in smaller sizes, big hooks with large diameter hook eyes. The two side sockets allow to apply the eyes. Available in 5 different sizes.



Ces petites têtes sont identiques en forme et dimensions aux "Streamer fish heads" mais elles ont la particularité d'être réalisés en matériau transparent et élastique. L'élasticité du matériau permet d'insérer, même dans les petites tailles, grands hameçons avec œilletons de diamètre important. Deux niches latérales permettent de placer les yeux. Disponibles en 5 tailles différentes.

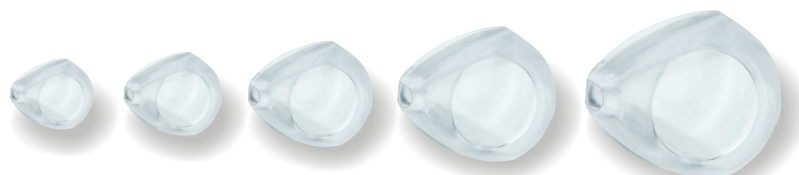

Mis.1 2 3 4 5

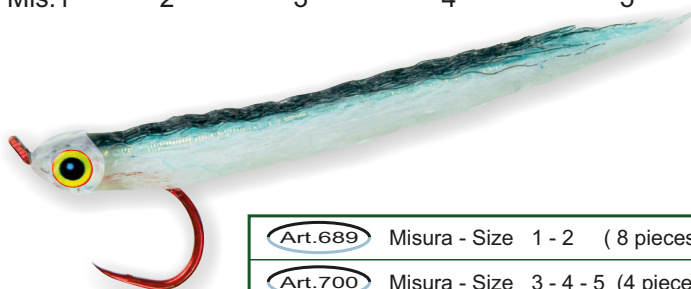

Art.689	Misura - Size 1 - 2	(8 pieces per bag)
Art.700	Misura - Size 3 - 4 - 5	(4 pieces per bag)

Art.518 **COLLA CYANOX**

CYANOX GLUE



Collante cianoacrilico a essiccazione rapida indispensabile per costruire mosche artificiali, tube flies etc. etc. Boccetta con dosatore contagocce molto preciso. Prodotto deperibile da conservare in frigo.



Instant cyanoacrylate glue suitable for tying flies, tube flies etc. etc. Bottle with very accurate applicator. Perishable product store in the fridge.



Colle cyanoacrylate à prise ultra rapide pour le montage de mouches, tube flies etc.etc. Flacon doseur compte-gouttes très précise. Produit périssable conserver au réfrigérateur.

BUSTA DA 1 PEZZO - CONF. DA 10 PEZZI
1 PIECE PER BAG - PACK SIZE 10 PIECES

CONT. 10 GR



Art.649 POLYMULTIFIL



- Filato multifibra in polipropilene, leggerissimo, idrorepellente, è ideale per l'imitazione di ali, la realizzazione di dubbing in asola, dubbing brush etc. Disponibile in 16 colori.
- Polypropylene multifiber yarn, very lightweight, water-repellent, ideal for wings, dubbing loop, dubbing brush, etc. Available in 16 colours.
- Fibres synthétiques en polypropylène, très légères, hydrofuges, elles sont idéales pour imiter les ailes, réaliser dubbing à boucle, dubbing brush, etc. Disponibles en 16 couleurs.

30 PZ. X 50 CM - CONF. DA 10 BUSTE * 30 PCS X 50 CM - PACK SIZE 10 BAGS



Art.658 SYNT OVAL TAPE

- Materiale traslucido ed elastico a sezione semi-ovale, ideale per la realizzazione di corpi segmentati di ninfe. Disponibile in 3 misure e 7 differenti colori.
- Translucent and elastic material with semi-oval section, ideal to tie segmented body of nymphs. Available in 3 sizes and 7 different colours.
- Matériau translucide et élastique de section semi-ovale, idéal pour le montage de corps bosselés du nymphes. Disponible en 3 tailles et 7 couleurs.

Mis Sizes		1	2	3
LxH mm		mm 0,8 x 0,3	mm 1,2 x 0,5	mm 1,8 x 0,8
Colours		natural yellow orange	red olive brown	smoke-grey

BUSTA DA 3 METRI - CONF. DA 10 BUSTE * 3 METRES PER BAG - PACK SIZE 10 BAGS



Art.659 SYNT FLAT TAPE

- Materiale traslucido ed elastico a sezione piatta, ideale per la realizzazione di sacche alari, gamberi, dorsi di terrestri etc... Disponibile in 7 differenti colori.
- Translucent and elastic material with flat section, ideal to tie wing pads, shrimps, terrestrial, etc... Available in 7 different colours.
- Matériau translucide et élastique de section plate, idéal pour le montage de sacs alaires, crevettes, terrestres, etc... Disponible en 7 couleurs

LxH mm		mm 4,0 x 0,4
Colours		natural yellow orange red olive brown smoke-grey

BUSTA DA 1 METRO - CONF. DA 10 BUSTE * 1 METRE PER BAG - PACK SIZE 10 BAGS



Art.575 TINSEL

- Tinsel sintetico molto resistente. Sostituisce perfettamente il metallico ma la sua applicazione risulta più semplice grazie alla sua capacità di adattamento alle varie superfici. 3 colori e 4 misure.
- Synthetic tinsel. Very strong, not elastic, it is very easy to work thanks to its flexibility. 3 colours and 4 sizes.
- Tinsel synthétique. Il est très solide, pas élastique, facile à travailler grâce à son flexibilité. 3 couleurs et 4 tailles.

Colours	Silver - Gold - Red
Mis.Size mm	0,5 0,8 1,2 1,5

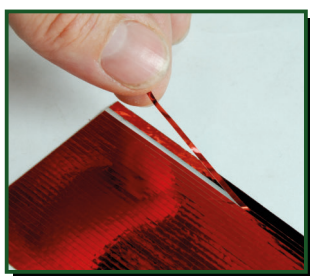

BUSTA DA 1 PEZZO - CONF. DA 10 BUSTE
1 PIECE PER BAG - PACK SIZE 10 BAGS

Lunghezza - Length
cm 13

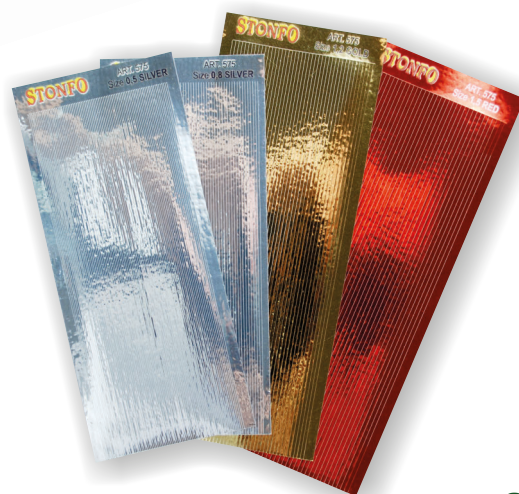

Art.601 SYNTHETIC FILM



- Pellicola olografica e iridescente per la realizzazione di esche artificiali. Prodotta in tre colori. Dim. 55x135 mm.*
- Holographic and iridescent film. It can be used for many types of lures. Available in three colours. Dim.55x135 mm.*
- Pellicule holographique et iridescente pour la réalisation des leurres. Produite en trois couleurs. Dim.55x135 mm.*

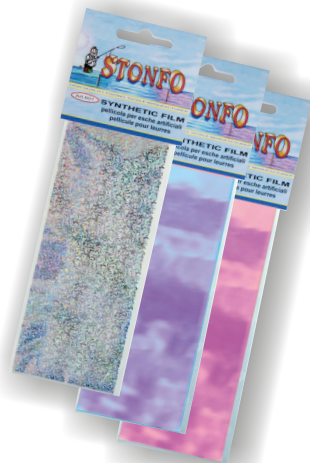

BUSTA DA 2 FOGLI - CONF. DA 10 BUSTE * 2 SHEETS PER BAG - PACK SIZE 10 BAGS

Art.513 3D FISHSCALE ADHESIVE TAPE

Mis Sizes	Small		Big	
Colori Colours	Bianco White	Rosso Red	Oro Gold	Verde Green

- Film adesivo olografico con squame in rilievo per la personalizzazione di esche artificiali.*
- Holographic adhesive tape with relief fishscales.*
- Autocollant holographique avec écailles in relief pour la personnalisation des leurres.*

BUSTA DA 2 FOGLI - CONFEZIONE DA 10 BUSTE
2 SHEETS PER BAG - PACK SIZE 10 BAGS

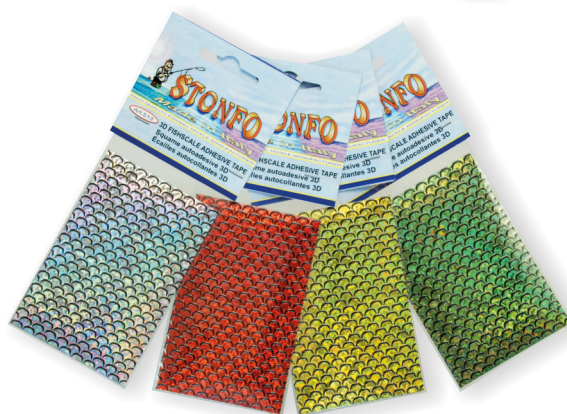

Art.540 LIVREA FLUO ADHESIVE TAPE

- Disegno decorativo stampato in rilievo su supporto fluorescente adesivo utile per la personalizzazione di esche artificiali. 2 colori.*
- Relief pattern printed on fluorescent adhesive tape. Suitable to customize your lures. 2 colours.*
- Dessin décoratif imprimé en relief sur autocollant fluorescent. Idéal pour la personnalisation des leurres. 2 couleurs.*

BUSTA DA 2 FOGLI - CONFEZIONE DA 10 BUSTE
2 SHEETS PER BAG - PACK SIZE 10 BAGS

Arancio fluorescente
Fluo Orange 57X93 mm

Giallo fluorescente
Fluo Yellow 57X93 mm



HOLO LURE EYES

- Art.511** Misure piccole
Small sizes
- Art.512** Misure grandi
Big sizes

- Occhi adesivi lenticolari olografici per la costruzione e personalizzazione di esche artificiali.*
- Holographic adhesive lure eyes.*
- Yeux autocollants lenticulaires holographiques pour leurres.*

Colori Colours	
Small Sizes	Ø mm 2,0 -2,5 -3,0 -3,5 -4,0 -5,0

CONFEZIONE DA 24 PZ. - PACK SIZE 24 PIECES

Colori Colours	
Big Sizes	Ø mm 7,0 - 9,0 - 12,0

CONFEZIONE DA 12 PZ. - PACK SIZE 12 PIECES

FLUO LURE EYES

- Art.538** Misure piccole
Small sizes
- Art.539** Misure grandi
Bigl sizes

- Occhi adesivi lenticolari fluorescenti ottimi per la costruzione e personalizzazione di esche artificiali.*
- Fluorescent adhesive lure eyes. Suitable to customize your lures.*
- Yeux autocollants lenticulaires fluo pour leurres. Idéaux pour la personnalisation des leurres.*

Colori Colours	
Small Sizes	Ø mm 2,0 -2,5 -3,0 -3,5 -4,0 -5,0

CONFEZIONE DA 24 PZ. - PACK SIZE 24 PIECES

Colori: Arancio Giallo	
Big Sizes	Ø mm 7,0 - 9,0 - 12,0

CONFEZIONE DA 12 PZ. - PACK SIZE 12 PIECES

Art.597 PLASTIC EYES

 Occhietti in materiale plastico ideali per la realizzazione di esche artificiali tipo streamers, ninfe, gamberi, libellule etc etc. Confezionati per colore ed assortiti nelle tre misure.

 Small plastic eyes great on dragonfly, nymph, crayfish etc etc. Packed by colour in assorted three sizes.

 Petits yeux en plastique idéaux pour la réalisation de libellules, nymphes, crevettes etc etc. Livrés en sachet d'une même couleur en trois tailles assorties.





COLORI - COLOURS:
 Trasparente - Clear
 Nero - Black
 Arancio - Orange fluo
 Verde - Green fluo



BUSTA DA 48 PZ. - CONF.10 BUSTE
48 PCS PER BAG - PACK SIZE 10 BAGS

Art.598 PLASTIC EYES V TYPE

 Occhietti divergenti in materiale plastico ideali per la realizzazione di esche artificiali tipo granchi, gamberi etc etc. Confezionati per colore ed assortiti nelle due misure.

 Small divergent plastic eyes great on crab, crayfish etc etc. Packed by colour in assorted two sizes.

 Petits yeux divergents en plastique parfaits pour la réalisation de crabes, crevettes etc etc. Livrés en sachet d'une même couleur en deux tailles assorties.



COLORI - COLOURS:
 Trasparente - Clear
 Nero - Black
 Arancio - Orange fluo
 Verde - Green fluo



BUSTA DA 20 PZ. - CONF.10 BUSTE
20 PCS PER BAG - PACK SIZE 10 BAGS

ATTRACTOR BEADS

Art.545	ATTRACTOR BEADS				
Colori	Giallo	Arancio	Rosso	Verde	Fucsia
Colours	Yellow	Orange	Red	Green	Fuchsia
Mis Sizes	Ø mm 3,0 -4,0				

Art.546	ATTRACTOR BEADS MAXI				
Colori	Giallo	Arancio	Rosso	Verde	Fucsia
Colours	Yellow	Orange	Red	Green	Fuchsia
Mis Sizes	Ø mm 5,0 -6,0 -7,0				

BUSTA DA 40 PERLINE - CONFEZIONE DA 10 BUSTE
40 BEADS PER BAG - PACK SIZE 10 BAGS

BUSTA DA 20 PERLINE - CONFEZIONE DA 10 BUSTE
20 BEADS PER BAG - PACK SIZE 10 BAGS

 Perline in gomma dai colori fluorescenti. Montate direttamente sull'esca artificiale oppure sul filo vicino all'amo rendono più attrattiva la montatura aumentando così le probabilità di cattura. Adatte sia per le acque interne che per la pesca in mare. Disponibili in 5 brillanti colori e 5 diverse misure.

 Fluor-colour rubber beads. Place one of them over the hook eye or add more beads on the rig close to the hook, for better fish attraction. Suitable for all types of fishing. Available in 5 bright colours and 5 different sizes.

 Perles en caoutchouc des couleurs fluorescentes. Elles peuvent être disposées sur les empiles devant l'hameçon ou sur l'hameçon même en rendant plus attractif le montage. Indiquées pour tous les types de pêche. Disponibles en 5 brillantes couleurs et 5 différentes tailles.

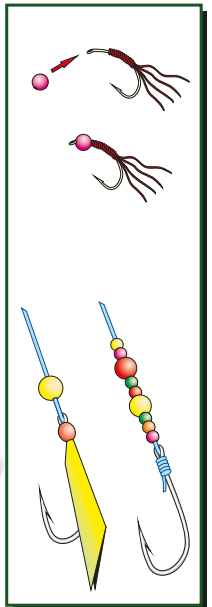

Art.524 REALISTIC EGGS

 Imitazioni realistiche di uova di trota e salmone, realizzate in materiale morbido traslucido altamente adescante. Si applicano direttamente sull'amo sia singolarmente che a grappolo o per mezzo del blocco esca art.139.

 Attractor soft translucent beads that imitate the trout and salmon eggs. Fix one or more beads directly on the hook or by the bait holder item 139.

 Perles imitation d'œufs de poisson en matériau souple translucide à utiliser directement sur l'hameçon seul, en chapelet ou par l'art. 139 bloque esche.

BUSTA DA 20 PERLINE - CONFEZIONE DA 10 BUSTE
20 BEADS PER BAG - PACK SIZE 10 BAGS

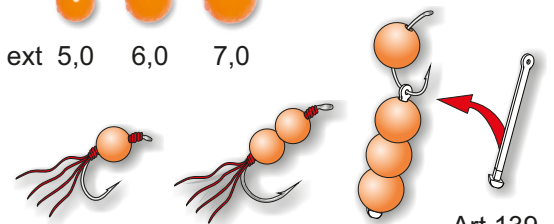
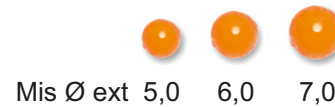

Art.139
Bait holder

Art.619 PALETTE MINI MINI LURE LIPS - MINI BAVETTES POUR LEURRES

 Palette in policarbonato trasparente per dare a streamers, poppers e artificiali da mare il giusto affondamento con movimenti oscillanti e turbolenze adescanti. Una piccola feritoia, nella quale si inserisce l'amo, agevola il posizionamento della palette ed il suo bloccaggio all'inclinazione voluta. Fornite con pesi di diversa grandezza per stabilizzare e variare l'affondamento dell'artificiale.

 Polycarbonate clear lips specially designed to give to streamers, poppers and sea lures the right sinking with oscillating action and turbulence trails. A little slot to insert the hook, makes easy the positioning of the lip and its locking at the desired angle. Supplied with different stabilizing weights to change the sinking of the lure.

 Bavettes en polycarbonate transparent pour donner aux streamers, poppers et leurres pour la mer le juste plongeon et pour créer des mouvements oscillants et turbulences dans l'eau. Une petite fente, dans laquelle est inséré l'hameçon, facilite le positionnement de la bavette et son blocage à l'angle voulu. Livrées avec poids de différentes tailles pour stabiliser et changer le plongeon du leurre.

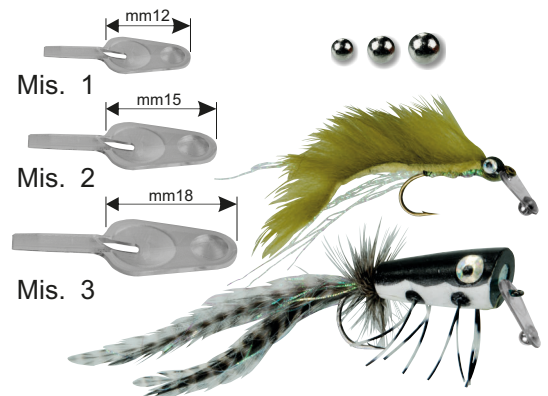

BUSTA DA 10 PZ. - CONF.5 BUSTE
10 PCS PER BAG - PACK SIZE 5 BAGS

Art.633 **ANTI-ALGA WEED GUARD**

 L'anti-alga è un componente utilissimo da utilizzare su artificiali tipo poppers, streamers, zonker etc, è prodotto in materiale plastico elastico e resistente. L'anti-alga si applica all'amo legando una sua estremità allo stelo in modo che l'estremità opposta, munita di speciale nicchia a V, vada a proteggere la punta dell'amo impedendone l'incaglio durante l'azione di pesca. Adatto per ami della dimensione massima 2-3/0. Disponibile in 3 colori che consentono di incrementare l'efficacia dell'artificiale.

 The weed guard is a very useful device perfect for lures like poppers, streamers, zonkers, etc. It is made of elastic and strong plastic material. The weed guard can be locked on the hook by tying one of its ends on the hook shank so that the special V slot located in the opposite end protects the hook point from weeds while retrieving the lure. Suitable for hooks up to 2-3/0 size. Available in 3 colours that improve lure efficacy.

 L'anti-algues est un composant très utile, parfait pour une utilisation sur leurres comme poppers, streamers, zonker etc, il est produit en matériau plastique élastique et résistant. L'anti-algues s'applique à l'hameçon liant une de ses extrémités à la tige de sorte que l'extrémité opposée, munie de spéciale fente à V, protège la pointe de l'hameçon contre les algues pendant la récupération du leurre. Il est apte pour hameçons de taille maximale 2-3/0. Disponible en 3 couleurs pour une meilleure efficacité du leurre.

BUSTA DA 10 PEZZI - CONF. DA 10 BUSTE
10 PIECES PER BAG - PACK SIZE 10 BAGS

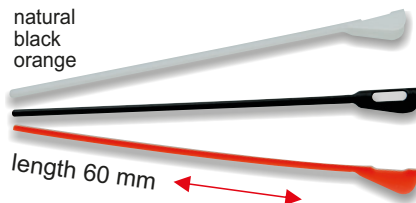

Art.646 **TUBULAR LIGHT SHANK**

 Shanks innovativi realizzati con micro-tubo in acciaio inox del Ø esterno di 0,8 mm. Grazie alla sezione tubolare questi shanks, oltre ad essere più leggeri, mantengono una maggiore rigidità in fase di montaggio dell'artificiale e un carico di rottura elevato. Per la realizzazione di artificiali articolati si possono montare più shanks in serie.

 Innovative shanks manufactured with stainless steel micro-tube Ø ext.0,8 mm. Thanks to their tubular section these shanks are lighter, stronger and maintain higher rigidity during tying operations. Series of shanks can be mounted to tie articulated streamers.

 Shanks innovants réalisés en micro-tube en acier inox Ø ext.0,8 mm. Grâce à leur forme tubulaire ces shanks sont plus légers, plus résistants et au même temps plus rigides pendant le montage. Peuvent être montés en série pour réaliser des streamers articulés.

BUSTA DA 10 PEZZI - CONF. DA 10 BUSTE
10 PIECES PER BAG - PACK SIZE 10 BAGS

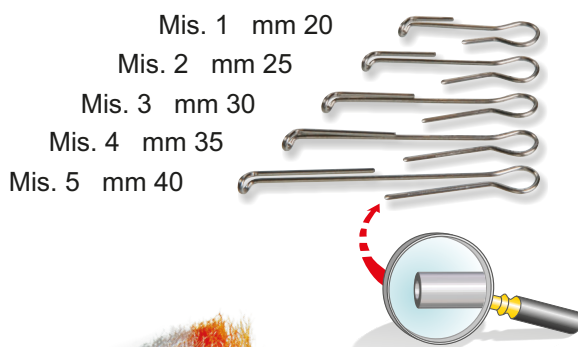

Art.647 **TUBULAR STRONG SHANK**

 Shanks innovativi per artificiali di grandi dimensioni, essi sono realizzati con micro-tubo in acciaio inox del Ø esterno di 1,0 mm. Grazie alla sezione tubolare questi shanks, oltre ad essere più leggeri, mantengono una maggiore rigidità in fase di montaggio dell'artificiale e un carico di rottura elevatissimo. Per la realizzazione di artificiali articolati si possono montare più shanks in serie.

 Large size innovative shanks manufactured with stainless steel micro-tube Ø ext.1,0 mm. Thanks to their tubular section these shanks are lighter, extra strong and maintain higher rigidity during tying operations. Series of shanks can be mounted to tie articulated streamers.

 Shanks de grande taille, innovants, réalisés en micro-tube en acier inox Ø ext.1,0 mm. Grâce à leur forme tubulaire ces shanks sont plus légers, extra résistants et au même temps plus rigides pendant le montage. Peuvent être montés en série pour réaliser des streamers articulés.

BUSTA DA 10 PEZZI - CONF. DA 10 BUSTE
10 PIECES PER BAG - PACK SIZE 10 BAGS

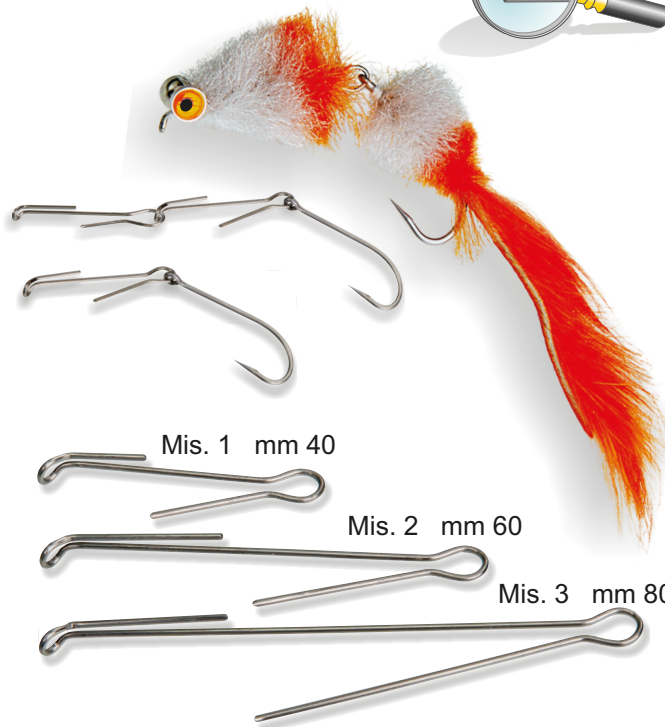

Art.594 **FIL TEC**

Mis. Size 1 2 3 4 5

 Filato sintetico a sezione piatta, elastico ed opalescente. Ideale per ogni tipo di montaggio ed in particolare per la produzione di corpi realistici oppure tipo "stimulator" e "attractor". Ottimo per la realizzazione di zampe e antenne. Colorabile facilmente con i comuni pennarelli indelebili.

 Flat section synthetic yarn, elastic and opalescent. Suitable for any type of tying and in particular realistic bodies or "stimulator" and "attractor" flies. It's perfect to produce legs and antennae. It can be coloured easily with permanent markers.

 Fil synthétique à section plate, élastique et opalescent. Idéal pour tous les types de montage, des corps réalistes et "stimulator" ou "attractor" et parfait pour la réalisation des pattes et antennes. Peut être facilement coloré avec des marqueurs permanents.

BOBINA DA 15 METRI - CONF. DA 5 BOBINE * 15 METRES PER BOBBIN - PACK SIZE 5 BOBBINS



Art.599 JUNGLE COCK FANTASY



Imitazioni fantasia delle piume del gallo della giungla prodotte in quattro misure. Sono stampate su pellicola sintetica adesiva ad alta resistenza con effetto olografico. Ogni piuma ha il profilo pretagliato pronta all'uso. Sono di grande effetto nella costruzione di streamers, mosche da salmone, artificiali da mare, piccoli terrestri etc. etc.



Fantasy jungle cock synthetic feathers. Durable and thin they are printed on holographic adhesive synthetic sheets in four sizes. Each feather image is die-cut ready to use. They offer an impressive result in the realization of streamers, salmon flies, small lures etc. etc.



Imitations de fantasia de plumes jungle cock réalisées en quatre tailles. Durables et fines elles sont imprimées sur pellicule adhésive holographique et chaque plume est poinçonnée prêt à l'emploi. Idéales et de grand effet dans le montage de streamers, mouches à saumon, petits leurres etc. etc.



BUSTA DA 20 PIUME - CONFEZIONE DA 10 BUSTE
20 FEATHERS PER BAG - PACK SIZE 10 BAGS

Art.600 SYNTHETIC WINGS



COLOURS: BLUE HOLO RED HOLO RAINBOW HOLO IRIDESCENT



Alucce leggere e flessibili ottime per la realizzazione di sabiki e streamers. Sono stampate su pellicola sintetica ad alta resistenza con effetto olografico o iridescente. Ogni ala ha il profilo pretagliato pronta all'uso. Disponibili in tre grandezze e quattro colori.



Synthetic wings. Lightweight and flexible they are fantastic on sabiki and streamers. Printed on holographic or iridescent synthetic film each wing image is die-cut ready to use. Available in three sizes and four colours.



Ailes légères et flexibles idéales pour la réalisation de sabiki et streamers. Elles sont imprimées sur pellicule holographique ou iridescente et chaque aile est poinçonnée prêt à l'emploi. Produites en trois tailles et quatre couleurs.



BUSTA DA 12 ALUCCE-CONFEZIONE DA 10 BUSTE * 12 WINGS PER BAG - PACK SIZE 10 BAGS

Art.625 FOAM STRIKE INDICATORS



Indicatori d'abboccata in foam adesiva di colore giallo e arancio fluorescente. Di facile applicazione e posizionamento sul finale. Confezione colori assortiti.



Strike indicators in fluorescent yellow and orange adhesive foam. Easy to apply and position on the tippet. Bag with miscellaneous colours.



Indicateurs de touche en foam adhésif jaune et orange fluorescent. Facile à appliquer sont repositionnables sur le bas de ligne. Sachet couleurs assorties.

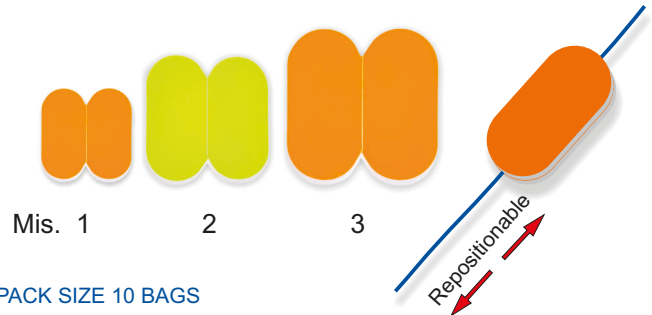

BUSTA DA 20 PEZZI - CONFEZIONE DA 10 BUSTE * 20 PIECES PER BAG - PACK SIZE 10 BAGS

Art.186 SEGNAFILO LINE SIGNAL - GUIDE FIL

Mis. 1	Mis. 2	Mis. 3
Ømm 5	mm 8	mm 11



Segnafile ideale per la pesca alla trota in torrente. Colori: giallo e rosso fluorescente. Disponibile in 3 diverse misure.



Line signal for stream trout. Colours: yellow and red fluorescent. Available in 3 sizes.



Guide-fil indicateur pour la pêche au toc. Couleurs: fluo jaune et rouge. Disponible en 3 tailles.



BUSTA DA 6 PEZZI - CONFEZIONE DA 10 BUSTE
6 PIECES PER BAG - PACK SIZE 10 BAGS

Art.378 SEGNAFILO INTERCAMBIABILE INTERCHANGEABLE LINE SIGNAL



Segnafile intercambiabile ideale per la pesca alla trota in torrente. Colori: giallo e rosso fluorescente. Disponibile in 3 diverse misure.



Interchangeable line signal for stream trout. Colours: yellow and red fluorescent. Available in 3 sizes.



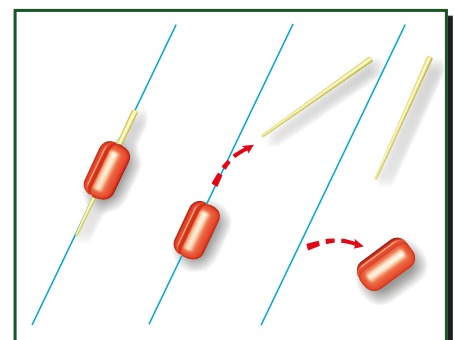
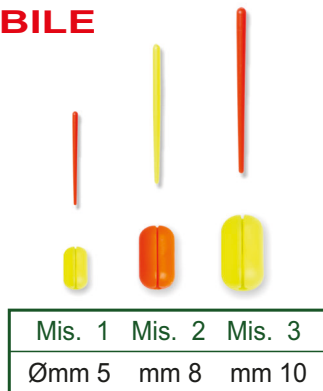

Guide-fil indicateur pour la pêche au toc. Modèle interchangeable. Couleurs: fluo jaune et rouge. Disponible en 3 tailles.



BUSTA DA 6 PEZZI - CONFEZIONE DA 10 BUSTE
6 PIECES PER BAG - PACK SIZE 10 BAGS

Art.523 **JOINT RINGS**

 Micro anello in lega leggera resistente permette di cambiare facilmente il terminale senza tagliare il finale conico. La sua forma è perfettamente arrotondata. Adatto sia per finali galleggianti che affondanti non influenza il lancio e l'azione di pesca.

 Micro ring in strong lightweight alloy, allows a quick change of the tippet without cutting the tapered leader. The ring shape is well rounded. Suitable for both floating and sinking leaders, it doesn't influence the casting action.

 Micro bague en alliage léger résistant permet de changer facilement la pointe sans couper le bas de ligne "queue de rat". Sa forme est parfaitement arrondie. Indiquée pour bas de ligne flottant et plongeant, son emploi ne modifie pas le lancer.

BU. DA 10 PZ - CONF. DA 10 BU.
10 PCS PER BAG - PACK SIZE 10 BAGS

Real size



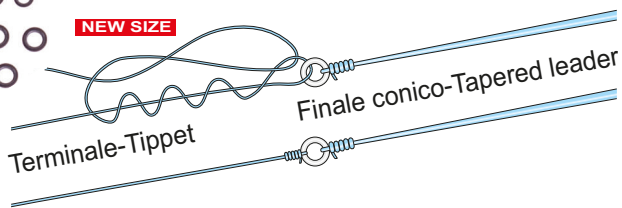

mis. size	dim. mm Ø ext.	peso weight	resistenza strength
1	mm 2,0	gr 0,002	Strength 4 kg
2	mm 2,5	gr 0,005	Strength 8 kg
3	mm 3,3	gr 0,016	Strength 18 kg

NEW SIZE



Art.427 **CAST CONNECTOR**

 Il cast connector costituisce il sistema più pratico per la connessione coda-finale. La sua forma completamente smussata permette un passaggio agevole tra gli anelli della canna. Disponibile nei colori neutro o arancio fluo per una maggiore visibilità. Due misure per ogni tipo di coda.

 The cast connector is an ideal junction between fly line and leader. Thanks to its smoothed shape runs freely through rod guides. Available in natural or fluo-orange colours for a better visibility. Two sizes for every kind of fly line.

 Le cast connector est le dispositif idéal pour connecter le bas de ligne à la soie. Sa forme réduite et cunéiforme permet un facile passage par les anneaux de la canne. Disponible dans les couleurs naturelle ou orange-fluo pour une meilleure visibilité. Deux tailles pour tous les types de soie.

BUSTA DA 6 PEZZI - CONF. DA 10 BUSTE
6 PIECES PER BAG - PACK SIZE 10 BAGS

Colori - colours:
Natural
Orange fluo



Misure - sizes	1	2
Coda - fly line	3 - 6	7 - 12

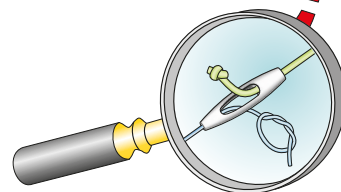



Art.584 **COPRINODO**

KNOT COVER

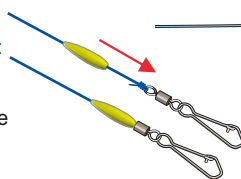

Colori - colours:
neutro - natural
giallo - yellow
arancio - orange
verde - green
nero - black



 Gommino coprinodo utilissimo per ogni genere di pesca. La sua forma biconica permette un passaggio agevole dagli anelli della canna. Fornito in 3 grandezze e 5 diversi colori è ottimo per la giunzione coda-finale e come rifinitura per streamers ed esche artificiali.

 Rubber knot cover suitable for all types of fishing. Its biconical shape allows easy passing through rod guides. Supplied in 3 sizes and 5 different colours, it is ideal for fly line-leader connection or for finishing of streamers and lures.

 Couvre-nœud indiqué pour tous les types de pêche. Sa forme biconique permet un passage facile dans les anneaux. Disponible en 3 tailles et 5 couleurs est idéal pour couvrir la jonction soie-ligne et pour la finition des streamers et leurres.

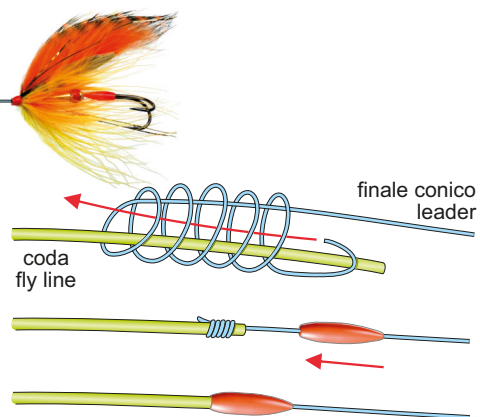

BUSTA DA 24 PEZZI - CONF. DA 10 BUSTE
24 PIECES PER BAG - PACK SIZE 10 BAGS

Art.706 **COPRINODO MAXI**

KNOT COVER MAXI

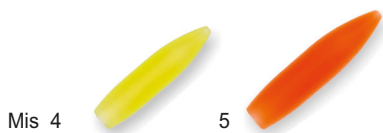

Colori - colours:
neutro - natural
giallo - yellow
arancio - orange
verde - green
nero - black

 Gommino coprinodo prodotto in due misure più grandi, ideale per l'utilizzo con monofili, elastici e code di dimensioni maggiori. La sua forma biconica permette un passaggio agevole dagli anelli della canna. Disponibile in cinque diversi colori.

 Rubber knot cover produced in two bigger sizes, ideal for monofilaments, elastics and fly lines of larger diameter. Its biconical shape allows easy passing through rod guides. Available in 5 different colours.

 Couvre-nœud produit en deux tailles plus grandes, idéal pour monofilaments, élastiques et soies de plus grand diamètre. Sa forme biconique permet un passage facile dans les anneaux. Disponible en 5 différents couleurs.

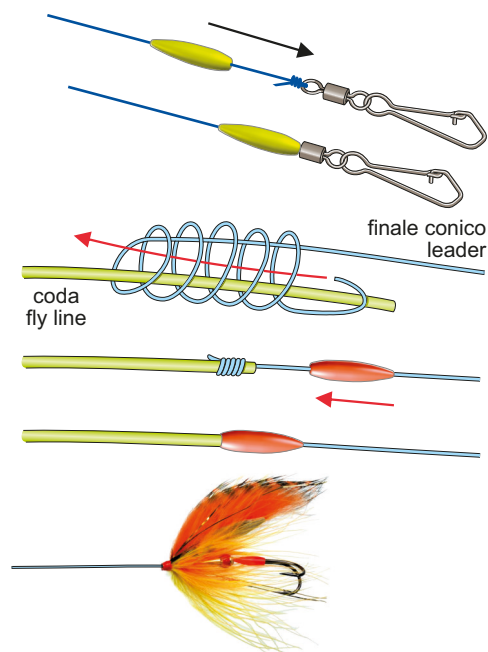

BUSTA DA 12 PEZZI - CONFEZIONE DA 10 BUSTE
12 PER BAG - PACK SIZE 10 BAGS

Art.652 NEEDLES SET

 Aghi ideali per la realizzazione di asole su trecciati tubolari o calzette. La confezione comprende due diverse misure.

 Needles suitable to produce loops on tubular braided line. The packaging includes two different sizes.

 Aiguilles idéales pour la réalisation des boucles sur fil tressé tubulaire. Le conditionnement comprend deux tailles différentes.

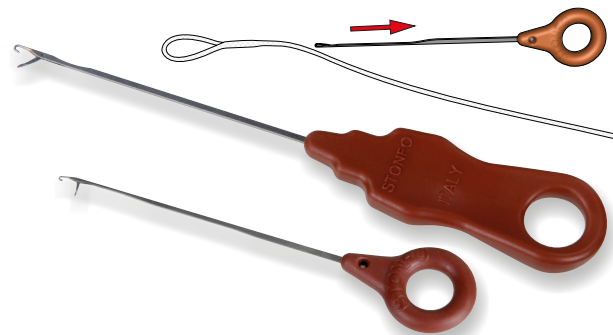

BUSTA DA 2 AGHI - CONF. DA 10 BUSTE
2 NEEDLES PER BAG - PACK SIZE 10 BAGS

Art.623 DROPPER CLIPS

 Piccoli agganci leggerissimi in policarbonato utilissimi per la pesca a dropper e quando si pesca con più mosche. Permettono la libera rotazione del bracciolo e la sua rapida sostituzione. Forniti completi di micro perline.

 Very small ultralight polycarbonate clips ideal for dropper fishing and when fishing with more flies. They allow the free rotation of the droppers and their quick replacement. Supplied with micro beads.

 Petites perles d'accrochage très légères en polycarbonate idéales pour la pêche avec un train de mouches. Elles permettent une libre rotation de la potence et son remplacement rapide. Fournies des micro perles de butée.

BUSTA DA 20 PZ. - CONF. DA 10 BU.
20 PCS PER BAG - PACK SIZE 10 BAGS

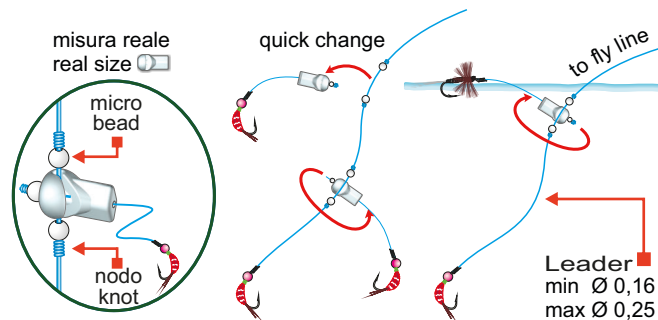

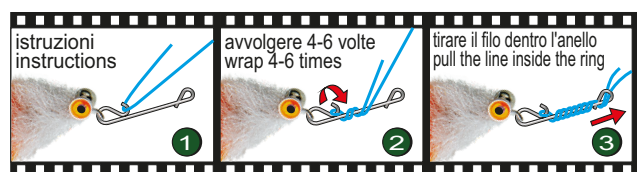

Art.435 NO NODO SPECIAL FAST SNAP

- Mis.1 Line Max 0,20
- Mis.2 Line Max 0,25
- Mis.3 Line Max 0,30
- Mis.4 Line Max 0,40
- Mis.5 Line Max 0,50
- Mis.6 Line Max 0,80



 "No Nodo" è un moschettone rapido speciale che permette di collegare lo streamer al finale senza fare nodi, mantenendo così inalterato il carico di rottura del filo. Prodotto in acciaio inox in 6 differenti misure.

 Special fast snap, suitable to attach without knot the streamer to tippet. It is made of stainless steel in 6 different sizes.

 Agrafe inox spéciale, idéale pour accrocher le streamer à le bas de ligne sans faire nœuds. Disponible en 6 tailles.

BUSTA DA 10 PZ. - CONF. DA 10 BU.
10 PCS PER BAG - PACK SIZE 10 BAGS

Art.636 QUICKLINK ROUNDED SHAPE

 Moschettoni in acciaio inox ad attacco rapido. La loro forma arrotondata permette la massima libertà di movimento all'esca artificiale.

 Stainless steel snaps for quick change. The rounded shape allows greater freedom of movement to the lures.

 Agrafes en acier inox à fixation rapide. Leur forme arrondie permet une complète liberté de mouvement des leurres.

BUSTA DA 10 PZ. - CONF. DA 10 BU.
10 PCS PER BAG - PACK SIZE 10 BAGS

Mis. Size	0	1	2	3	4
Strength kg	4	6	9	18	34

Art.638 QUICKLINK ELLIPTICAL SHAPE

 Moschettoni in acciaio inox ad attacco rapido. Il loro design ellittico permette una connessione in linea con la lenza madre oltre ad una resistenza notevolmente superiore.

 Stainless steel snaps for quick change. Their elliptical shape allows a perfectly in-line connection with the mainline and a greater strength.

 Agrafes en acier inox à fixation rapide. Leur forme elliptique permet une jonction avec la ligne parfaitement en axe et une résistance considérablement supérieure.

BUSTA DA 10 PZ. - CONF. DA 10 BU.
10 PCS PER BAG - PACK SIZE 10 BAGS

Mis. Size	0	1	2	3	4
Strength kg	7	10	16	30	48

Art.637 **WIRELINK CLIP**

 Moschettoni in acciaio inox ad attacco rapido appositamente studiati per essere utilizzati con cavetto o filo in acciaio. La loro forma è da una parte arrotondata per permettere la massima libertà di movimento dell'artificiale mentre dalla parte opposta è stretta per avere una connessione di ridotte dimensioni e il cavetto perfettamente in linea con il moschettone. Forniti con tubetto termoretraibile della misura idonea.

 Stainless steel snap for quick change, ideal to connect monostrand wire or tress wire. The Wirelink Clip has a rounded part to allow greater freedom of movement to the lure, while the opposite side is narrow to have a small size connection with the wire perfectly in-line. Supplied complete with shrinkable tube of the appropriate size.

 Agrafes en acier inox à accrochage rapide étudiées pour être utilisées avec fil d'acier tressé ou monofil d'acier. Les Wirelink Clips ont une partie arrondie pour permettre une complète liberté de mouvement des leurres tandis que la partie opposée est étroite pour avoir une jonction très petite avec le fil d'acier parfaitement en axe. Livrées avec gaine rétractable de taille appropriée.

BUSTA DA 6 PZ. - CONF. DA 10 BU.
6 PCS PER BAG - PACK SIZE 10 BAGS



GUARANTEED STRENGTH

Mis. Size	0	1	2	3
Strength kg	4	10	18	25
Strength lbs	9	22	40	55

Art.701 **LURE SNAPS**



Mis. Size	1	2	3
Strength kg	5	8	14
Hook Size	14-8	6-1	1/0-6/0

GUARANTEED STRENGTH

 Permettono un cambio rapido di mosche ed artificiali senza fare nodi ed accorciare ogni volta il terminale. Prodotti in acciaio inox molto resistente in 3 misure.

 They allow to change quickly flies and lures without tying knots and shorten the dropper every time. Produced in high strength stainless steel. Available in 3 sizes.

 Ces agrafes permettent un changement rapid de mouches et leurres sans faire noeuds et raccourcir chaque fois le bas de ligne. Produites en acier inox de haute resistance en 3 tailles.

BUSTA DA 5 PEZZI - CONF. DA 10 BUSTE
5 PIECE PER BAG - PACK SIZE 10 BAGS



Art.624 **REEL LINE CLIP**

 Dispositivo ferma-filo, piccolissimo, adesivo, si applica al mulinello in modo rapido e stabile. Al suo interno un micro anellino in silicone garantisce un ottimo bloccaggio del finale senza danneggiarlo.

 Line locking device, very small, adhesive, it is applied to the reel in a quick and stable way. Inside the clip a micro silicone ring guarantees a firm locking without damaging the tippet.

 Dispositif bloque-fil pour moulinet, très petit, adhésif, s'applique à la bobine de manière rapide et stable. À l'intérieur un micro anneau en silicone assure un excellent blocage du bas de ligne sans l'endommager.

BUSTA DA 2 PZ. - CONF. DA 10 BU.
2 PCS PER BAG - PACK SIZE 10 BAGS



Art.679 **STONFO ROD HOLDER**

 Piccolo e leggero permette di assicurare la canna al gilet per avere le mani libere durante le operazioni di cambio dell'artificiale, sostituzione del finale, slamatura del pesce etc.etc. Realizzato in gomma ad alta elasticità Stonfo Rod Holder si fissa al gilet grazie ad una speciale clip a cursore. Ideale per ogni tipo di canna da 7 a 10 mm di diametro.

 Compact and lightweight allows to hang the rod securely to the vest in order to have your hands free while changing the lure, replacing the tippet, releasing a fish etc.etc. Made of highly elastic rubber the Stonfo Rod Holder can be attached to the vest by a special slider clip. Ideal for every type of rod from 7 mm to 10 mm diameter.

 Compact et léger, il permet de maintenir la canne solidement au gilet pour avoir les mains libres pendant le changement de leurre, le remplacement de bas de ligne, le décrochage d'un poisson etc.etc. Il est produit en caoutchouc très élastique, le Stonfo Rod Holder se fixe à la veste avec une spéciale agrafe à curseur. Idéal pour tous les types de canne de 7 mm à 10 mm de diamètre.

BLISTER DA 1 PEZZO - CONFEZIONE DA 5 PEZZI
1 PIECE BLISTER PACK - PACK SIZE 5 PIECES



Art.502 SPILLO DI SERVIZIO DOUBLE TAPER NEEDLE

 *Attrezzo utilissimo per ripulire l'occhiello dell'amo o per sciogliere i nodi più difficili. Munito di speciale punta affilatissima a doppia conicità in acciaio inox retraibile a molla. Impugnatura soft touch.*

 *Useful tool to clean hook eyes or untie knots. Equipped with a sharp double taper stainless steel needle. Soft touch handle. Spring-loaded retraction of the needle.*

 *Aiguille pour déboucher les petits œillets et défaire les nœuds. La pointe inox à double conicité est rétractable par ressort. Poignée anatomique soft touch.*

BUSTA DA 1 PEZZO - CONFEZIONE DA 10 BUSTE * 1 PIECE PER BAG - PACK SIZE 10 BAGS

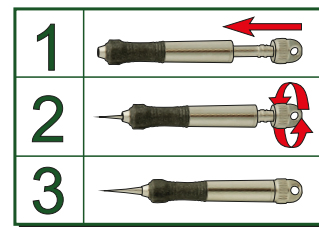

Art.527 FLY PATCH

 *Placchetta appendi-mosche in gomma ondulata espansa ad alta densità ottima anche per ami senza ardiglione. Si applica al gilet per mezzo di una spilla di sicurezza. Dimensione della gomma 80x48 mm.*

 *Ripple foam fly patch designed to hold flies. Suitable also for barbless hooks. Equipped with safety pin attachment. Foam dimension 80x48 mm.*

 *Accroche-mouches en mousse crantée à haute densité. Idéale aussi pour hameçons sans ardillon. Equipé avec épingle de sûreté. Dimension de mousse 80x48 mm.*

BUSTA DA 1 PEZZO - CONFEZIONE DA 10 BUSTE * 1 PIECE PER BAG - PACK SIZE 10 BAGS



gomma espansa morbida soft foam

Art.605 FLY PATCH ELITE

 *Placchetta appendi mosche in gomma ondulata espansa ad alta densità con copertura di protezione trasparente in polipropilene. Il fondo di questa struttura scatolare è magnetico e chiuso ai lati per evitare la perdita di mosche. Di pratico utilizzo si fissa al gilet per mezzo di una spilla di sicurezza. Dim. mm 85X60.*

 *Ripple foam fly patch with polypropylene clear cover to protect flies. The bottom of this boxlike structure is magnetic and is closed at both sides to avoid the loss of flies. Equipped with safety pin attachment. Dimensions: length 85 mm; width 60 mm.*

 *Accroche-mouches en mousse crantée à haute densité est équipé d'un volet transparent de protection en polypropylène. Cette structure en forme de boîte a un fond aimanté avec les côtés fermés pour éviter la perte des mouches. S'attache au gilet par une épingle de sûreté. Dim. mm 85X60.*

BU. DA 1 PZ. - CONF. DA 10 BUSTE * 1 PIECE PER BAG - PACK SIZE 10 BAGS



fondo magnetico magnetic bottom



lati chiusi closed sides

Art.533 SAFETY CORD

 *Molla in materiale plastico durevole con clip e moschettone. Utilissima per agganciare qualsiasi utensile, scatola o altri accessori al gilè o ai pantaloni.*

 *Spring, made of durable plastic material, with clip and snap. Suitable for attaching tools, boxes or other accessories on your vest or pants.*

 *Ressort en plastique durable avec clip et agrafe. Très utile pour accrocher à votre gilet ou pantalon outils, boîtes ou autres accessoires.*

BU. DA 1 PEZZO - CONF. DA 10 BUSTE * 1 PIECE PER BAG - PACK SIZE 10 BAGS

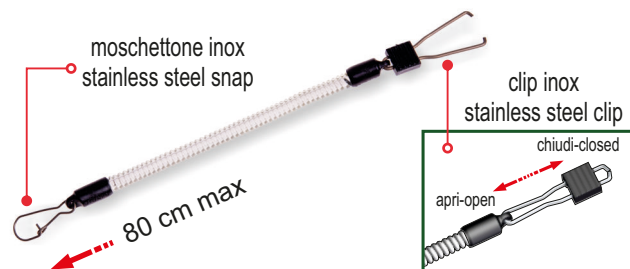

moschettone inox stainless steel snap

clip inox stainless steel clip

80 cm max

chiudi-closed

apri-open

Art.525 BOTTON SERVICE

 *Bottono di servizio con molla in materiale plastico durevole e di ottima potenza. Leggerissimo e compatto si applica al gilet per mezzo di una spilla di sicurezza. Estensione massima della molla cm 40. Moschettone in acciaio inox.*

 *Light and compact retractor. The plastic spring is powerful, durable and can be extended to 40 cm. Equipped with safety pin attachment for maximum security and stainless steel snap.*

 *Bouton de service petit et léger. Le ressort en plastique est puissant, durable et s'allonge jusqu'à 40 cm. Equipé avec épingle de sûreté et agrafe en acier inox.*

BU. DA 1 PEZZO - CONF. DA 10 BUSTE * 1 PIECE PER BAG - PACK SIZE 10 BAGS





spilla di sicurezza safety pin attachment

moschettone inox stainless steel snap

40 cm max

Art.526 BOTTON SERVICE DOPPIO

 *Bottono di servizio con doppia molla in materiale plastico durevole e di ottima potenza. Leggerissimo e compatto si applica al gilet per mezzo di una spilla di sicurezza. Estensione massima delle molle cm 35. Munito di gomma ondulata espansa ad alta densità utile per appendere le mosche. Moschettoni in acciaio inox.*

 *Light and compact retractor with double plastic spring. The springs are powerful, durable and can be extended to 35 cm. Equipped with safety pin attachment for maximum security, small flies holder patch and stainless steel snaps.*

 *Bouton de service petit et léger à ressort double. Le ressort en plastique est puissant, durable et s'allonge jusqu'à 35 cm. Equipé avec épingle de sûreté, mousse crantée accroche-mouches et agrafes en acier inox.*

BU. DA 1 PEZZO - CONF. DA 10 BUSTE * 1 PIECE PER BAG - PACK SIZE 10 BAGS

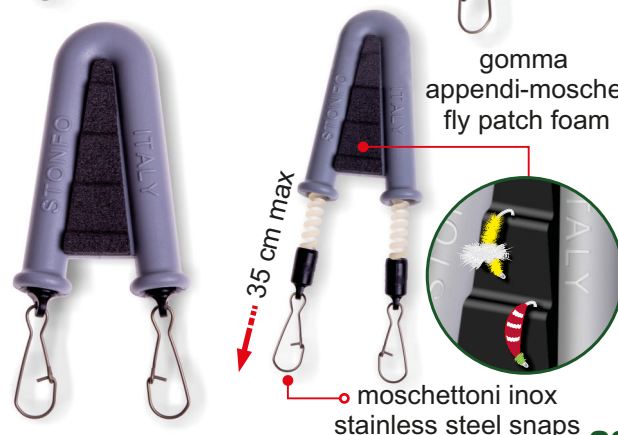

gomma appendi-mosche fly patch foam

moschettoni inox stainless steel snaps

35 cm max

Art.622 BOTTON SERVICE MINI

Ø 9,5 x 27 mm



Bottone di servizio di dimensioni molto compatte munito di magneti di grande potenza. Ideale per appendere, pronti all'uso, piccoli accessori come taglia-filo, slamatore etc. sia al gilet che alla collana.



Very compact tool holder, with strong magnets. Ideal to hold on the vest, ready to use, small accessories like line-cutter, disgorging etc.



Bouton de service très compact avec des aimants de forte puissance. Permet d'accrocher, prêt à l'emploi, les petits accessoires tels que coupe-fil, dégorgeoir etc.

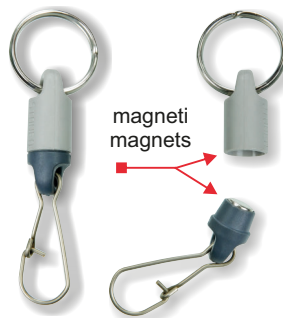

magneti magnets

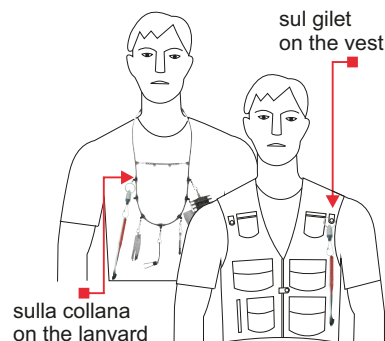

BUSTA DA 1 PEZZO - CONFEZIONE DA 5 PEZZI
1 PIECE PER BAG - PACK SIZE 5 PIECES

Art.520 BOTTON SERVICE MAGNETICO

Bottone di servizio con forti magneti per appendere pronto all'uso il guadino, il raffietto o altri accessori. La molla in materiale plastico durevole ha una buona potenza e si estende fino a cm 130.



Retractor with strong magnets for holding net, small gaff or other accessories. The plastic spring is powerful, durable and can be extended to 130 cm.



Bouton de service avec forts aimants pour attacher une épuisette, une gaffe légère ou d'autres accessoires. Le ressort en plastique est puissant, durable et s'allonge jusqu'à 130 cm.

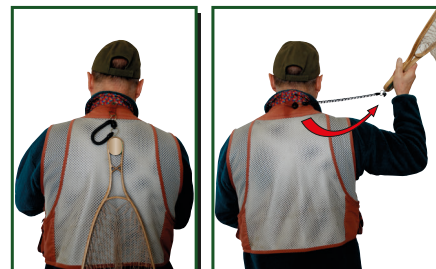

BUSTA DA 1 PEZZO - CONFEZIONE DA 5 PEZZI
1 PIECE PER BAG - PACK SIZE 5 PIECES

Art.531 NYLON DISPENSER

Distributore di nylon per finali, con 8 bobine e doppio tagliafilo. Formato tascabile. Munito di anello di aggancio. Dim. 8x8x2 cm. Filo non incluso.



Leader-tippet nylon dispenser, with 8 spools and double cutter. Pocket size. Equipped with ring attachment. Dim. 8x8x2 cm. Nylon not included.



Distributeur de nylon avec 8 bobines et double coupe fil. Format de poche. Muni de anneau d'accroche. Dim. 8x8x2 cm. Fourni sans nylon.

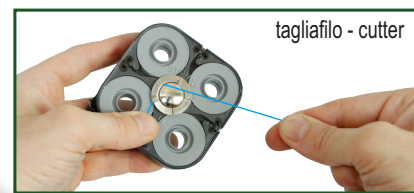

tagliafilo - cutter

BU. DA 1 PZ. - CONF. DA 5 BUSTE
1 PIECE PER BAG - PACK SIZE 5 BAGS

Art.611 STENDIFINALI**LEADER STRAIGHTENER - REDRESSEUR DE BAS DE LIGNE**

Accessorio in materiale plastico con all'interno due guancette in gomma speciale. Utilissimo per stendere il finale rapidamente ed efficacemente. La sua forma anatomica permette di dosare in modo adeguato la forza da applicare. Munito di foro per l'aggancio al gilet.



Useful small tool to straighten the leader quickly and safely. It is made of strong plastic material with two special rubber pads inside. Its anatomic shape allows to apply the desired force. Equipped with eyelet to hang it on a tool holder.



Pince en plastique avec à l'intérieur deux spéciales plaquettes en caoutchouc, très utile pour redresser rapidement et facilement les bas de ligne. Sa forme anatomique permet de régler la force que doit être appliqué. Munie de trou d'accroche.

BUSTA DA 1 PEZZO - CONFEZIONE DA 10 BUSTE * 1 PIECE PER BAG - PACK SIZE 10 BAGS

forza minore
lower force
petite forceforza maggiore
bigger force
grande force**Art.616 PULISCI & INGRASSA CODA****FLY LINE CLEANER - NETTOYEUR DE SOIE**

Accessorio utilissimo per pulire ed ingrassare la coda. Realizzato in materiale plastico con all'interno due guancette di feltro. Il suo utilizzo è molto semplice, basta far passare lentamente la coda attraverso le guancette di feltro precedentemente trattate col Fly line grease art.464. La sua forma anatomica permette di dosare in modo adeguato la forza da applicare. Munito di foro per l'aggancio al gilet.



Useful small tool for fly line cleaning, it is made of strong plastic material with two felt pads inside. Very easy to use, you only have to pass slowly your fly line through the two pads previously soaked with the Fly line grease (item 464). Its anatomic shape allows to apply the desired force. Equipped with eyelet to hang it on a tool holder.



Pince en plastique avec à l'intérieur deux tampons en feutre, très utile pour nettoyer la soie. Il suffit de faire passer lentement la soie entre les feutres précédemment graissés avec le Fly line grease art.464. Sa forme anatomique permet de régler la force que doit être appliqué. Munie de trou d'accroche.





BUSTA DA 1 PEZZO - CONFEZIONE DA 10 BUSTE * 1 PIECE PER BAG - PACK SIZE 10 BAGS

Art.730

LURE-LINE HOLDER

 Gancetto studiato per bloccare l'amo alla canna da pesca. Si applica alla canna per mezzo di o-ring forniti in varie dimensioni. La sua forma speciale lo rende inoltre particolarmente adatto per avvolgere il finale sulla canna da Tenkara.

 Holder designed to secure the hook to the fishing rod. It can be attached to the rod thanks to o-rings supplied in different sizes. Its special shape makes it also particularly suitable to wind the tippet on Tenkara rods.

 Crochet conçu pour fixer l'hameçon à la canne à pêche. Il s'applique à la canne au moyen de o-ring fournis en différentes tailles. Sa forme spéciale le rend aussi particulièrement adapté pour enrouler le bas de ligne sur la canne de Tenkara.

BUSTA DA 2 PZ. - CONF. DA 10 BU. * 2 PIECES PER BAG - PACK SIZE 10 BAGS



Art.705

STRIPPING BASKET

 Cestello per coda, prodotto con materiale molto resistente, può essere posizionato rapidamente sia alla vita che sulla gamba per mezzo di due cinture a sgancio rapido. I nove coni anti-groviglio di cui è munito hanno una speciale forma a pinna di squalo per garantire una ottimale fuoriuscita della coda durante il lancio. Dotato di sede poggia canna. Dimensioni 360x280x65 mm

 Stripping basket, made from high resistance material, can be positioned quickly both to the waist and to the leg thanks to two quick release belts. Its nine anti tangle cones have a special shark fin shape that allows the line to slip off easily during the cast. Equipped with grooves to hold the rod. Dimensions: 360x280x65 mm

 Panier de lancer, produit en matériau très résistant, peut être positionné rapidement soit à la taille soit à la jambe par deux ceintures à dégagement rapide. Les neuf cônes anti-emmêlement ont une forme spéciale d'aileron de requin pour assurer une sortie optimale de la soie pendant le lancer. Il est muni de logement support canne. Dimensions: 360x280x65 mm

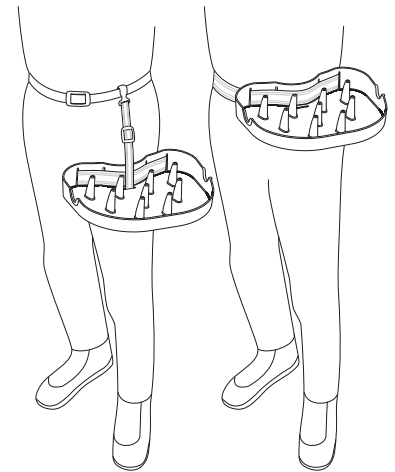



CONFEZIONE DA 1 PEZZO
PACK SIZE 1 PIECE

Art.665

SLAMA RELEASER FOR TROUT AREA

 Grazie a questi slamatori e all'utilizzo di ami senza ardiglione è possibile slamare il pesce direttamente in acqua senza toccarlo. Muniti di sistema telescopico con blocco a cursore per ridurre la lunghezza quando non in uso. Sono disponibili in due diverse misure con istruzioni per l'uso.

 Thanks to these disgorgers and to the use of barbless hooks, you can unhook a fish while it is still in the water without touching it. Equipped with telescopic system with locking slider to reduce their length when not in use. Available in two different sizes with instructions.

 Grâce à ces dégorgeoirs et à l'utilisation d'hameçons sans ardillon vous pouvez décrocher un poisson directement dans l'eau sans le toucher. Munis de système télescopique avec blocage à curseur pour réduire leur longueur lorsqu'ils ne sont pas en cours d'utilisation. Disponibles en deux différentes tailles avec notice d'emploi.

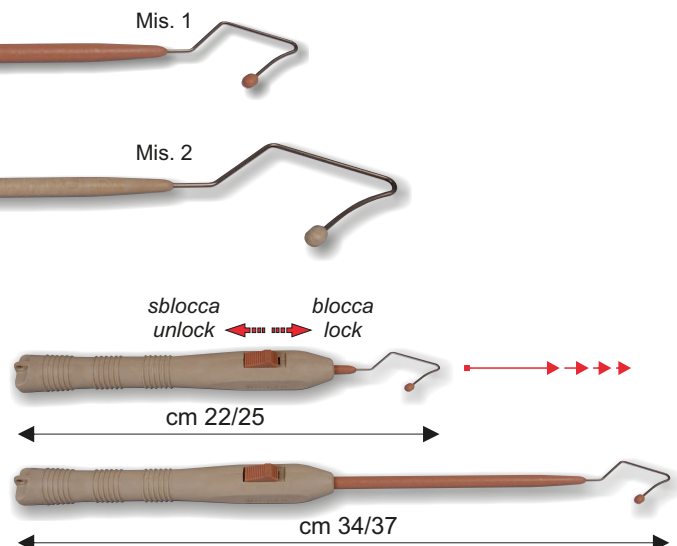

BUSTA DA 1 PEZZO - CONFEZIONE DA 5 BUSTE
1 PIECE PER BAG - PACK SIZE 5 BAGS

Art.615

SLAMATORI TUBETECH

TUBETECH DISGORGERS
DÉGORGEOIRS TUBETECH

Mis. Size	1	2	3
amo-hook	28 to 16	16 to 8	8 and larger



Slamatore di alta qualità con testina sagomata tubolare, studiato per una rapida estrazione dell'amo senza danneggiare la mosca ed il pesce. Prodotto con materiale molto resistente e con impugnatura anatomica in gomma. Ottimo per ogni tipo di pesca è indispensabile quando si pratica il catch and release. Munito di foro per l'aggancio al gilet.



High quality disgorger with shaped tubular head, designed for a quick hook release without damaging fly or fish. Produced with very strong material and with anatomic rubber handle. Fantastic for every kind of fishing it is indispensable for the catch and release. Equipped with eyelet to hang it on a tool holder.



Dégorgeoir d'haute qualité avec tête tubulaire, étudié pour l'extraction rapide de l'hameçon sans endommager la mouche et le poisson. Produit en matériau très résistant et avec poignée anatomique en caoutchouc. Excellent pour tous les types de pêche et indispensable pour le catch and release. Munie de trou d'accroche.

BUSTA DA 1 PEZZO - CONFEZIONE DA 10 PEZZI
1 PIECE PER BAG - PACK SIZE 10 PIECES

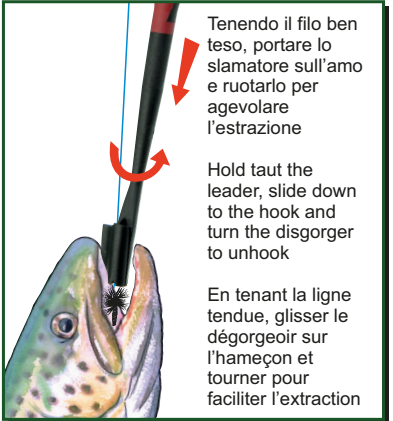
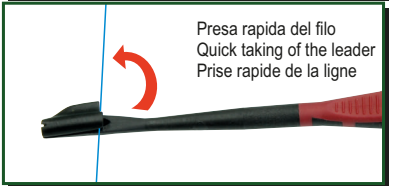

Art.660

SUPER JAW DISGORGER

SLAMATORE A PISTOLA - DÉGORGEOIR PISTOLET



Slamatore a pistola dal design ergonomico ideale per slamare anche in profondità pesci muniti di denti aguzzi. La presa dell'amo è agevole e forte come una pinza metallica. Comodo da trasportare grazie al suo peso estremamente ridotto, solo 60 grammi, e alle sue dimensioni compatte. Munito di impugnatura anti-scivolo è prodotto con materiali resistenti all'ossidazione. Indispensabile nel catch and release per ridurre i tempi di slamatura senza danneggiare la preda.



Pistol grip disgorger with ergonomic design, ideal to unhook sharp-toothed fishes even when very deeply hooked. The grip on the hook is strong as metal pliers. Can be transported easily thanks to its lightweight, only 60 grams, and its pocket-size. Provided with no-slip handle, it is produced with corrosion resistant materials. Indispensable in catch and release to reduce unhooking time without damaging the fish.



Dégorgeoir pistolet avec design ergonomique idéal pour décrocher aussi très en profondeur poissons à dents pointues. Le blocage de l'hameçon est facile et fort comme une pince métallique. Pratique à transporter grâce à son poids réduit, seulement 60 grammes, et sa taille compacte. Muni de poignée antidérapante il est produit avec matériaux anti-corrosion. Indispensable pour le catch and release pour réduire les temps de décrochage sans endommager le poisson.

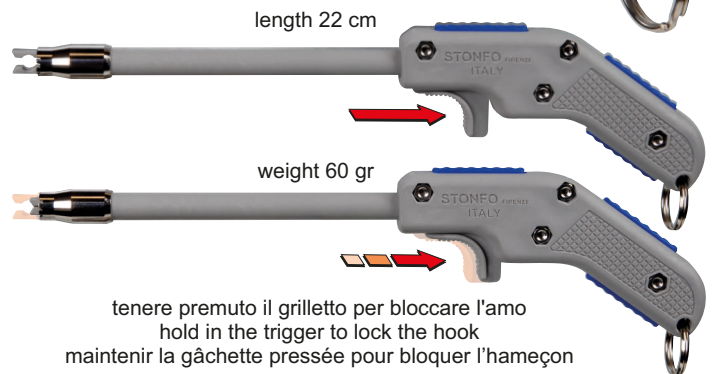
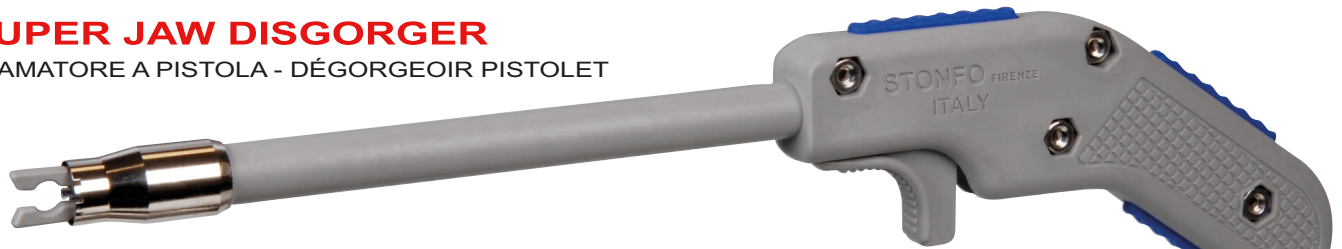

BUSTA DA 1 PEZZO - CONFEZIONE DA 5 BUSTE
1 PIECE PER BAG - PACK SIZE 5 BAGS

BILANCINE SCALES



Bilancine con molla in acciaio inox. Piccolissime, leggere, precise. Definizione misura 100 g (200 g art.487). Impugnatura comoda. Vite regolazione dello zero. Gancio di pesatura a scomparsa



Scales with spring in stainless steel. Very small, lightweight, accurate. Measure definition 100 g (200 g art.487). Comfortable handle. Can be zeroed by the screw. Folding weighing hook.



Pesons avec ressort en acier inox. Très petits, légers, précis. Graduation par 100 g (200 g art.487). Bonne poignée. Vis de réglage remise à zéro. Crochet de pesée repliable.

BUSTA DA 1 PEZZO - CONFEZIONE DA 10 PEZZI
1 PIECE PER BAG - PACK SIZE 10 PIECES

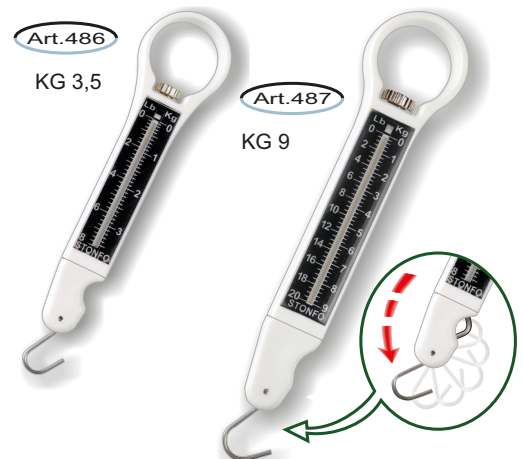

COMMAND GRIP PINZE SALPA PESCI - FISH LIP GRABBER - PINCES À POISSON



Pinze salpa pesci indispensabili per chi pratica il catch and release in quanto aiutano durante l'operazione di slamatura. Le caratteristiche speciali di queste pinze permettono di afferrare saldamente il pesce per la bocca senza arrecargli danno. Le loro ganasce sono perfettamente arrotondate, ricoperte in gomma ed hanno un'ampia superficie di contatto. La forza di chiusura della pinza viene controllata dal pescatore ed è indipendente dal peso del pesce. Leggerissime, compatte ma estremamente robuste queste pinze lavorano bene sia con pesci di piccola che di grossa taglia. Dotate di impugnatura ergonomica in gomma antiscivolo e di laccetto regolabile sono adatte sia per la pesca in acqua dolce che in mare. Per non ferire il pesce si consiglia comunque di sostenerne il peso con l'altra mano o se possibile di lasciare il pesce in acqua ed utilizzare la pinza come ausilio alla slamatura.



Fish lip grabbers, indispensable for the catch and release. The special features of these pliers allow you to grab the fish by the mouth without injuring it. The jaws are rubber coated and the rounded tips have a large contact surface, furthermore the closing force of the pliers can be adjusted by the angler. Ultra lightweight, compact with high strength body, these pliers are suitable for small and big size fishes. Perfect for both fresh and saltwater use. Their anatomic handle is in antiskid rubber. Supplied with adjustable wrist strap. To avoid harm to fish, we recommend to support its body with the other hand or if possible leave the fish in the water and only use the pliers to hold it while taking off the hook.



Pinces à poisson indispensables pour le catch and release. Les caractéristiques particulières de ces pinces permettent de saisir fermement le poisson par la bouche sans l'abîmer grâce à leur mâchoires avec une grande surface de contact et les bouts arrondis plus mous en caoutchouc. En plus, la pression de serrage est réglable par le pêcheur. Très légères et compactes mais extrêmement solides elles sont également adaptées pour poissons de petite et grande taille en mer comme en eaux douces. Munies de poignée en caoutchouc anti-glisse et d'un cordon réglable. Pour éviter de blesser le poisson nous conseillons de soutenir son corps avec l'autre main ou si possible laisser le poisson dans l'eau et utiliser la pince uniquement pour le temps d'ôter l'hameçon.

Art.617

COMMAND GRIP 1 ROCK FISHING MODEL

Dimensioni contenute cm 14
Small sized cm 14
Compacte cm 14

Leggerissima gr 70
Ultra light gr 70
Ultra légère gr 70

Comando di apertura
Button opening
Commande d'ouverture



Art.618

COMMAND GRIP 2

Dimensioni contenute cm 21
Small sized cm 21
Compacte cm 21

Leggerissima gr 150
Ultra light gr 150
Ultra légère gr 150

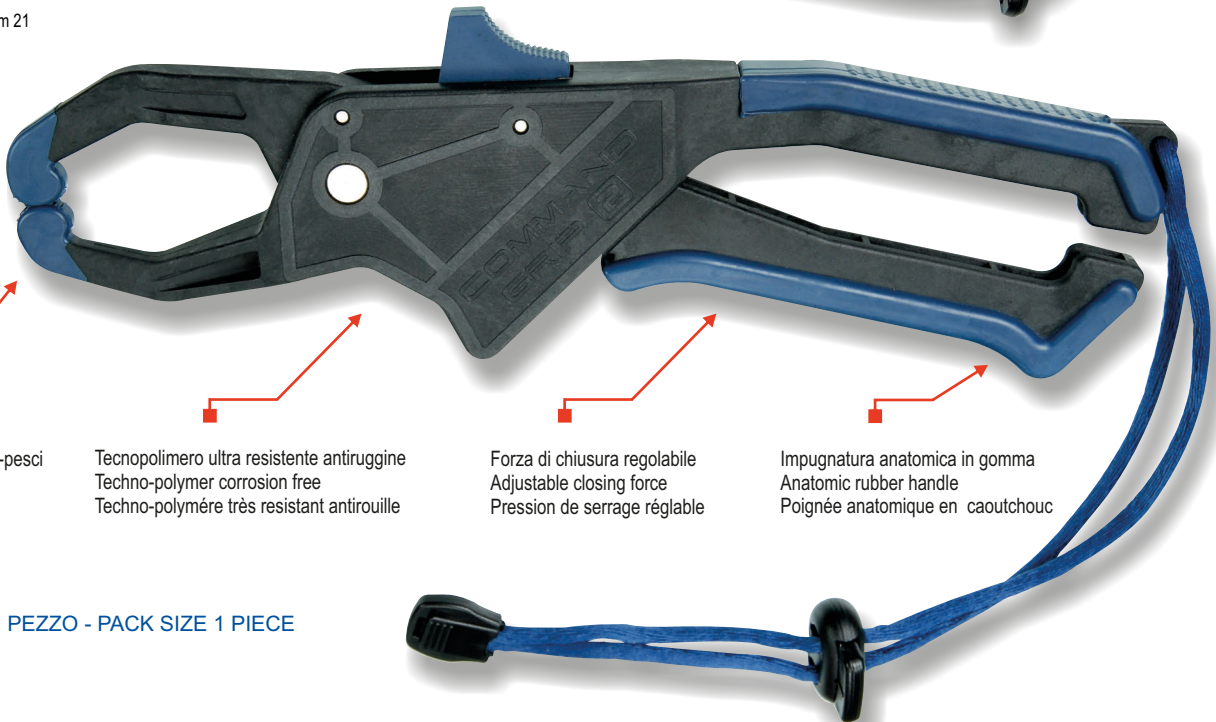

Ganasce in gomma salva-pesci
Fish saver rubber jaws
Mâchoires en caoutchouc
protège poisson

Tecnopolimero ultra resistente antiruggine
Techno-polymer corrosion free
Techno-polymère très résistant antirouille

Forza di chiusura regolabile
Adjustable closing force
Pression de serrage réglable

Impugnatura anatomica in gomma
Anatomic rubber handle
Poignée anatomique en caoutchouc

CONFEZIONE DA 1 PEZZO - PACK SIZE 1 PIECE

Art.537

PESCIOMETRO TAPE MEASURE FISH - MÈTRE MESURE POISSONS



Nastro impermeabile centimetrato misura-pesci. Sul nastro ci sono raffigurati molti pesci accanto ai quali è possibile annotare la misura minima ammessa. La confezione contiene inoltre adesivo con tabella misure minime per l'Italia. Lunghezza del nastro cm 60.



Waterproof measuring tape to measure fish you catch. On the tape there are many pictures of the fishes where is possible write the legal length. Tape length cm 60.



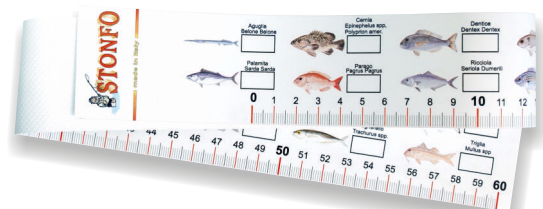

Mètre à ruban imperméable mesure-poissons. Muni des plusieurs dessins des poissons ou à côté de chaque on peut écrire les tailles légales minimales. Longueur du ruban cm 60.



BUSTA DA 1 PEZZO - CONFEZIONE DA 10 BUSTE
1 PIECE PER BAG - PACK SIZE 10 BAGS

Art.603 **COLLANA STONFO** FISHING NECK LANYARD

 Collana ultraleggera, molto resistente e confortevole. Stampata in gomma è munita di sei moschettoni inox di forma arrotondata per tenere a portata di mano vari accessori tipo slamatori, asciuga mosche, taglia filo, ago etc. Una speciale clip permette di assicurare la collana bloccandola alla cintura o alla camicia. Gli accessori non sono inclusi. Lunghezza 105 cm.

 Ultralight and very strong fishing neck lanyard. Moulded in comfortable rubber it has six rounded stainless steel snaps ideal to attach essential accessories like disgorgers, floatant, snips, needle etc. Equipped with a special clip to secure the lanyard to the shirt or pants. Accessories not included. Length 105 cm.

 Collier ultra léger, très résistant et confortable. Matricé en caoutchouc il est composé de six agrafes de forme arrondie en acier inox pour avoir à portée de main ce dont vous avez toujours besoin comme dégorgeoirs, sèche-mouches, coupe-fil, aiguille etc. Il est muni de clip spécial qui se pince à la ceinture ou à la chemise pour éviter le balancement. Les accessoires ne sont pas fournis. Longueur 105 cm.

BU. DA 1 PZ. - CONF. DA 5 PZ. * 1 PIECE PER BAG - PACK SIZE 5 PIECES



Art.548 **TIRANODO** TIGHTEN KNOT

 Accessorio che permette di serrare agevolmente il nodo anche su filo grosso e rigido.

 Useful tool that allows to tighten knot easily on big and rigid line too.

 Permet de serrer facilement le nœud aussi sur fil gros et rigide.

BUSTA DA 1 PEZZO - CONFEZIONE DA 10 BUSTE
1 PIECE PER BAG - PACK SIZE 10 BAGS

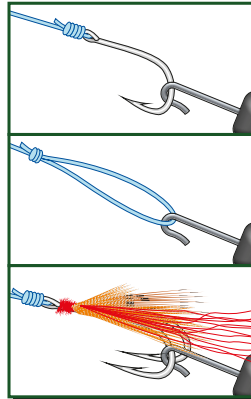

Art.631 **MAGNETIC ROD HOLDER**

 Piccolo accessorio in gomma morbida con magnete integrato, permette il fissaggio temporaneo della canna all'autovettura o a qualsiasi superficie metallica. Utilissimo durante la fase di preparazione alla pesca, evita che la canna possa cadere a terra.

 Small soft rubber accessory with a magnet inside, it holds the fishing rod on the car or any metallic surface. Very useful to keep fishing rod in a safe and secure position while preparing the fishing equipment.

 Petit accessoire en caoutchouc souple avec aimant intégré, permet la fixation temporaire de la canne à la voiture ou à toutes les surfaces métalliques. Très utile pendant la phase de préparation de la pêche, empêche à la canne de tomber au sol.

BU. DA 2 PZ.-CONF. DA 10 BUSTE * 2 PCS. PER BAG-PACK SIZE 10 BAGS



DRY FLY GEL & FLY LINE GREASE

 Art.463 Speciale pasta a bassa viscosità a base siliconica per un perfetto galleggiamento della mosca. Confezionata in scatolina con dischetto dosatore a microfori. Art. 464 Grasso per code. Aumenta la scorrevolezza in fase di lancio e migliora il galleggiamento della coda.

 Item 463 Special fly floatant low viscosity paste with silicon components. Easy open container with disc dispenser. Item 464 Line grease to increase the sliding and buoyancy of the fly line. Easy open container with disc dispenser.

 Art.463 Pâte spéciale enrichie au silicone pour une parfaite flottabilité des mouches. Conditionnée en boîte avec disque doseur microporcé. Art.464 Graisse pour soie. Améliore le glissement et la flottabilité des soies. Conditionnée en boîte avec disque doseur microporcé.



BUSTA DA 1 PEZZO - CONFEZIONE DA 10 BUSTE
1 PIECE PER BAG - PACK SIZE 10 BAGS

Art.547 **SUPER FLOAT FLY OIL**

 Olio speciale a base siliconica per un perfetto galleggiamento della mosca. La boccetta è appendibile al gilet da pesca e si apre facilmente con una sola mano.

 Fly floatant silicon oil. Bottle with eyelet to hang it on a tool holder. Equipped with one-hand fast opening device.

 Huile spéciale enrichie au silicone pour une parfaite flottabilité des mouches. Le flacon peut être agrafé directement au gilet et s'ouvre facilement d'une seule main.

BUSTA DA 1 PEZZO - CONFEZIONE DA 10 BUSTE
1 PIECE PER BAG - PACK SIZE 10 BAGS



Art.553 DRY FLY SPHERES

 *Microsfere ad alto assorbimento per asciugare rapidamente la mosca. Basta inserire la mosca legata al filo all'interno del flaconcino, chiudere il coperchio e scuotere energicamente più volte. Il flaconcino si apre facilmente con una sola mano.*

 *Highly absorbing microspheres to dry your fly. Put the fly tied to the leader into the container, close the lid and shake vigorously several times. Easy-open by one hand only.*

 *Microbilles avec grande capacité d'absorption pour sécher rapidement la mouche. Poser la mouche attachée au bas de ligne dans le flacon, fermer le couvercle et agiter vigoureusement plusieurs fois. Le flacon s'ouvre facilement d'une seule main.*

BUSTA DA 1 PZ. - CONF. DA 10 BU. * 1 PIECE PER BAG - PACK SIZE 10 BAGS

OLIO E GRASSO LUBRIFICANTI

 *Art 549 Olio speciale lubrificante idrorepellente. Ideale per mulinelli, anelli per canne etc.*
Art 554 Grasso al silicone ideale per lubrificare e proteggere le parti in metallo dalla corrosione.

 *Item 549 Special water-repellent lubricant oil. Ideal to lubricate reels, rod guides, etc...*
Item 554 Silicone grease ideal to lubricate and protect metal parts from corrosion.

 *Art 549 Huile spéciale lubrifiante hydrofuge. Idéale pour moulinets, anneaux des cannes etc.etc*
Art 554 Graisse silicone idéal pour lubrifier et protéger les parties en métal de la corrosion.

BUSTA DA 1 PZ. - CONF. DA 10 BU. * 1 PIECE PER BAG - PACK SIZE 10 BAGS



Art.549 OLIO LUBRIFICANTE

10 gr





Art.554 REEL LUBE GREASE

15 gr



Art.544 IMBOBINATORE SPOOLING STATION

 *Imbobinatore professionale manuale adatto per ogni tipo di bobina fino ad un diametro max di 20 cm. Munito di doppia molla per una regolazione ottimale della tensione del filo. Indispensabile per caricare il filo sulla bobina del mulinello, trasferire il filo da bobina a bobina per nylon dispenser, effettuare lavori come la preparazione di finali, calamenti etc. etc.*

 *Professional manual Spooling Station suitable for every type of bobbin up to 20 cm of diameter. Equipped with double spring for a perfect adjustment of the line tension. Useful to spool the line on the reel, transfer the line from the bobbin to the nylon dispenser bobbins, make various types of rigs.*

 *Station de bobinage professionnelle manuelle idéale pour tous les types de bobines jusqu'à 20 cm de diamètre. Munie de double ressort pour régler parfaitement la tension du fil. Indispensable pour charger le fil sur la bobine du moulinet, transférer le fil sur les bobines du nylon dispenser, réaliser différents montages.*

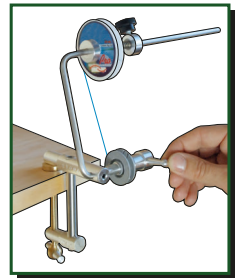

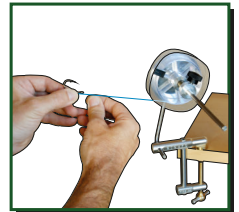
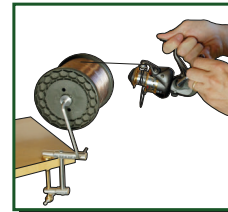

BUSTA DA 1 PEZZO
1 PIECE PER BAG



Art.234S FLY BAIT BOX dim. 95x45x16 mm

 *Scatolina per mosche con fondo in gomma.*

 *Fly box with foam base.*

 *Boîte à mouches avec fond en mousse.*

BUSTA DA 1 PZ. - CONF. DA 10 PEZZI
1 PIECE PER BAG - PACK SIZE 10 BAGS



Art.576 MINIBOX NYMPH dim.120x80x13 mm

 *Scatola anti-urto, leggera, molto sottile, con fondo in gomma ideale per contenere ninfe o piccole mosche. Munita di piccolo foro per l'applicazione al gilet.*

 *Shockproof lightweight box with foam base. Extra thin, is ideal for nymphs or small flies. Equipped with eyelet to hang it on the vest.*

 *Boîte légère, antichoc avec fond en mousse. De épaisseur extrafin est idéale pour ranger nymphes et petites mouches. Munie de petit trou d'accroche au gilet.*

BUSTA DA 1 PEZZO - CONF. DA 6 BUSTE * 1 PIECE PER BAG - PACK SIZE 6 BAGS



Art.243-1S FLY BOX MAGNUM CLEAR dim.150x100x20 mm

 *Scatola infrangibile per mosche con fondo in gomma ondulato e coperchio trasparente.*

 *Unbreakable fly box with ripple foam base and clear lid.*

 *Boîte à mouches incassable avec fond en mousse ondulée et couvercle transparent.*

BUSTA DA 1 PEZZO - CONFEZIONE DA 6 BUSTE * 1 PIECE PER BAG - PACK SIZE 6 BAGS



Art.243S FLY BOX MAGNUM 150x100x20 mm

 *Scatola infrangibile per mosche con gomma espansa piatta sul coperchio e ondulata sul fondo.*

 *Unbreakable fly box with flat foam lid and ripple foam base.*

 *Boîte à mouches incassable avec couvercle en mousse plate et fond en mousse ondulée.*

BUSTA DA 1 PEZZO - CONFEZIONE DA 6 BUSTE * 1 PIECE PER BAG - PACK SIZE 6 BAGS



LIGHT MAGNETIC BOXES dim. 150x100x20 mm

 Scatole anti-urto, leggere, trasparenti, munite di dischi magnetici in ogni scomparto.

 Clear fly boxes with magnetic discs on the bottom. Shockproof and lightweight.

 Boîtes à mouches magnétiques, légères, antichoc, transparents.

BUSTA DA 1 PEZZO - CONFEZIONE DA 6 BUSTE
1 PIECE PER BAG - PACK SIZE 6 BAGS

Art.270S



9 SCOMPARTI
9 DIVISIONS

Art.271S



15 SCOMPARTI
15 DIVISIONS

SCATOLE MAGNETICHE BUSTA DA 1 PEZZO

 Scatole magnetiche ultra-resistenti con coperchio trasparente. Confezioni da 1 pezzo.

 Unbreakable magnetic boxes with clear lid. Single packaging.

 Boîtes magnétiques incassables avec couvercle transparent. Livrées en sachet de 1 pièce.

BUSTA DA 1 PEZZO - CONFEZIONE DA 10 BUSTE
1 PIECE PER BAG - PACK SIZE 10 BAGS

Art.233 S

MAGNETIC
BOX



Art.267 S

ORANGE
MAGNETIC



Art.259 S

DOPPIO
MAGNETE





Art.248 S

SUPER
MAGNETE



Art.231 BABY MAGNETE dim. 85x57x16 mm BABY MAGNETIC BOX

 Scatola magnetica tascabile doppia, resistente agli urti, con 13 scompartimenti di varia grandezza, ognuno dotato di piano inclinato per facilitare l'estrazione degli ami. La scatola è fornita di penna magnetica.

 Pocket double sided magnetic box with 13 compartments. Each compartment has an inclined plane to take hooks out of the box easily. Supplied with a magnetic pencil.

 Boîte magnétique pochable double, incassable avec 13 compartiments. Plan incliné pour extraire les hameçons au moyen d'un stylo magnétique.

BUSTA DA 1 PEZZO - CONF. DA 3 BUSTE * 1 PIECE PER BAG - PACK SIZE 3 BAGS



SCATOLINE COMPONENTI MODULAR BOXES - PETITES BOÎTES POUR HAMEÇONS

 Scatoline componibili in plastica con coperchio a slitta trasparente per piccola minuteria come girelle, ami, perline etc.

 Modular boxes with sliding clear lid, ideal to contain small accessories like swivels, hooks, beads etc.

 Petites boîtes modulables avec couvercle coulissant transparent.

Dim.mm 40x27x9





Art.97 SCATOLINA PORTA AMI - MICRO SIZE SLIDE BOX (200 per bag)

Art.471 SCATOLINE COMPONENTI - MODULAR BOXES (10 per bag, pack size 10 bags)

Art.536 SCATOLE F TYPE dim. 120x85x25 mm

 Scatole anti-urto, leggere, trasparenti, compatte. Adatte per contenere vari tipi di artificiali, mosche, minuteria etc. Munite di piccolo foro per l'applicazione al Safety Cord.

 Shockproof lightweight clear boxes. Compact dimensions. Suitable to store various types of flies, lures and small rigs. Fitted with small hole for attaching to Safety Cord.

 Boîtes légères, antichoc, transparentes, compactes. Idéales pour ranger mouches, leurres et divers petits accessoires. Munies de petit trou d'accroche au Safety Cord.

BU. DA 1 PZ.-CONF. DA 6 BU. * 1 PIECE PER BAG-PACK SIZE 6 BAGS

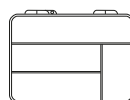

COMP. 4

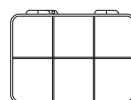

COMP. 6

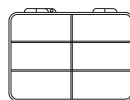

6 ORIZ.

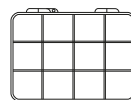

COMP. 12



Art.514 LIGHT BOX dim. 150x100x20 mm

 Scatola anti-urto, leggera, trasparente.

 Shockproof lightweight clear box.

 Boîte légère, antichoc, transparente.

BUSTA DA 1 PZ. - CONF. DA 6 BUSTE
1 PIECE PER BAG - PACK SIZE 6 BAGS



7 COMP.



9 COMP.





15 COMP.





WWW.STONFO.COM

 [stonfo_flyfishing](https://www.instagram.com/stonfo_flyfishing)
 [@stonfoflyfishing](https://www.tiktok.com/@stonfoflyfishing)