

5"/7"/12"/15"/19" Slimline Disk

The new EnVision SlimLine disk can be used in new construction and remodel applications. With the integration of edge-lit technology, driverless AC LED technology, and full dimmability, EnVision has created the most advanced disk on the market. It features two disk sizes (round or square), a slim width of 5/8", and is designed to be a one of a kind in the LED market.

Applications:

- Remodel and New Construction
- J-Box Installation: 30 or 40
- Recessed Can: 4" Can (5" model only) or 6" (7" model)

Product Information:

- Bracket: Replaceable bracket enables various ceiling installations
- AC Technology: slim and easy to install without a driver
- Edge-lit Technology: reduces glare with even light distribution
- Rated 50,000 hours life with a 5 year limited warranty
- Dimmable: Compatible with most dimmers down to 5% including Lutron DVCL-153P
- Wet Location Listed as a ceiling mount
- 'TRI' model can switch between 3000k, 4000k, & 5000k color temperatures (available for 5" & 7" fixtures only)
- 25W HV EMB with a full lumen output for 90 minutes

LED -

Product - Size/Shape/Watts - Color - Trims - Converter - EMB - Warranty

1

2

3

4

5

6

7

1 Product

SLRDSKR 5/7/12/15/19"
Round Disk
SLDSKSQ 5/7/12"
Square
Square Fixture
Only Available
in 5/7/12"

2 Size/Shape/Watts

5-10W 5" 10W / 650lm
7-15W 7" 15W / 1,000lm
12-22W 12" 22W / 1,450lm
15-30W 15" 30W / 2,000lm
19-35W 19" 35W / 2,200lm

3 Color

5CCT 27/30/35/40/50K
30K 3000K
TRI 30/40/50K
(30K Available
Only in 5",
7", & 12")

4 Trims

WHT White (incl.)
BLK Black
BZ Bronze
BN Brushed Nickel
CS Custom
15" & 19" White
or Custom Only

5 Converter

4-RK 4" Recessed
6-RK Can Converter
6" Recessed
Can Converter

6 EMB

(Blank) None
EMB Emergency
Backup

7 Warranty

(Blank) 5 Yr (incl.)
10YR 10 Yr

Specs and model numbers are subject to change with or without notice.

DIMENSIONS

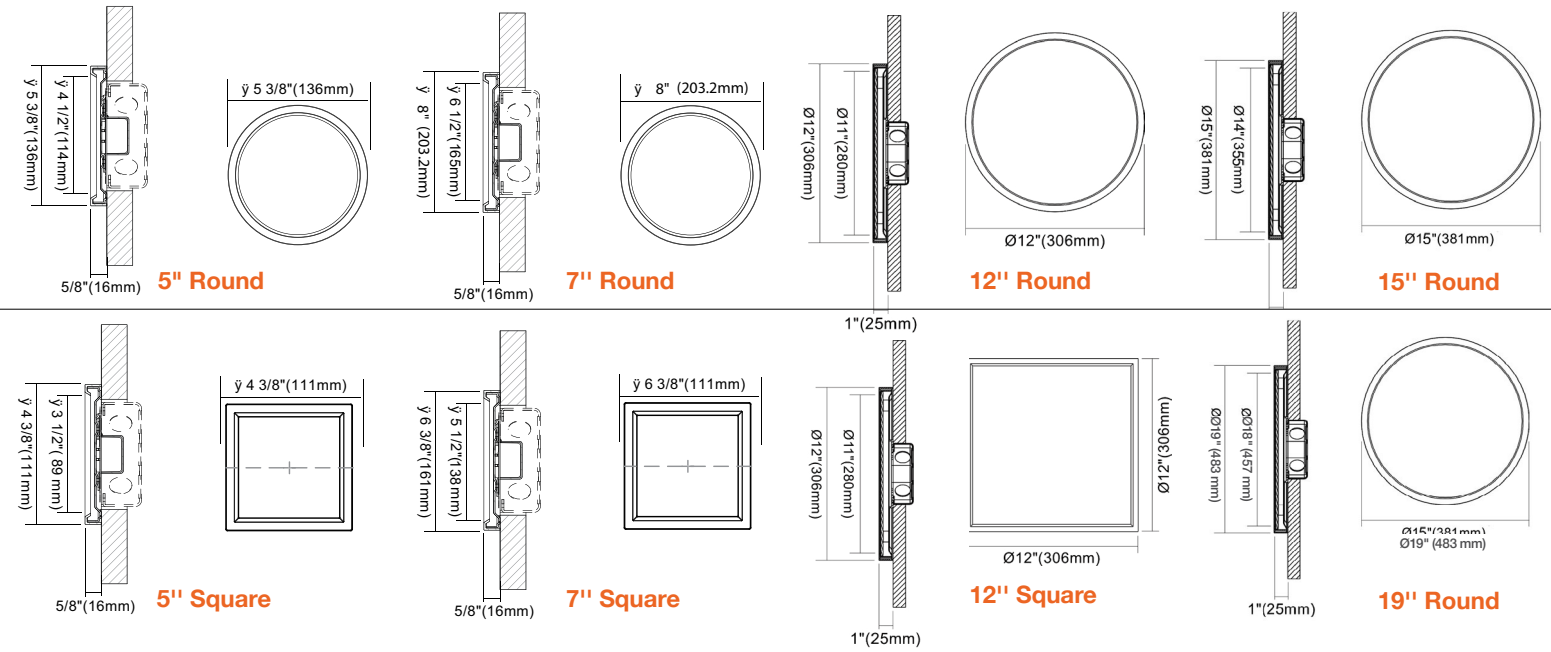

PHOTOMETRICS

5" Polar Graph

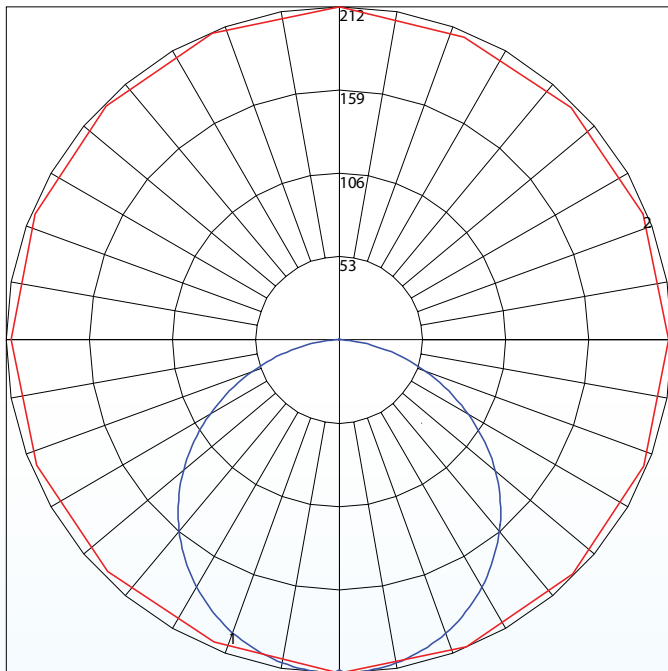

Maximum Candela = 212.42 Located At Horizontal Angle = 270, Vertical Angle = 1
 # 1 - Vertical Plane Through Horizontal Angles (270 - 90) (Through Max. Cd.)
 # 2 - Horizontal Cone Through Vertical Angle (1) (Through Max. Cd.)

7" Polar Graph

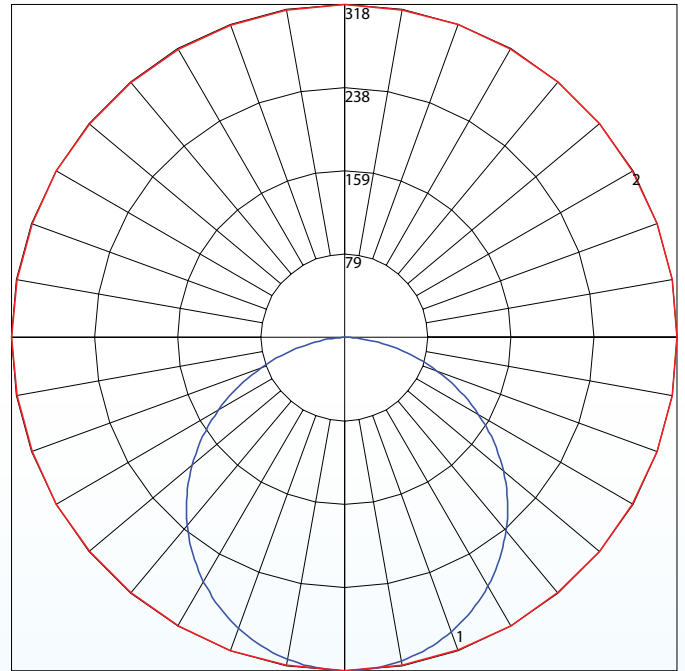

Maximum Candela = 317.89 Located At Horizontal Angle = 10, Vertical Angle = 1
 # 1 - Vertical Plane Through Horizontal Angles (10 - 190) (Through Max. Cd.)
 # 2 - Horizontal Cone Through Vertical Angle (1) (Through Max. Cd.)

CLIP-ON TRIMS - 5" / 7" / 12"



-BNI



-BLK



-BRZ



-BNI



-BLK



-BRZ

ACCESSORIES



SLDSK-7R-EMB-UNV

7" Emergency Backup Module

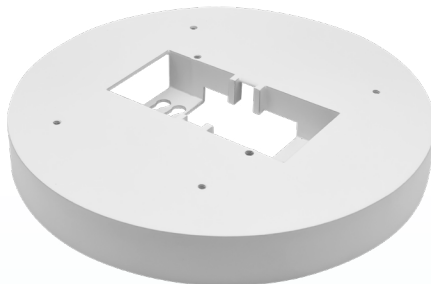

SLDSK-7R-EMB-EMPTY-UNV

7" Emergency Backup Empty Body

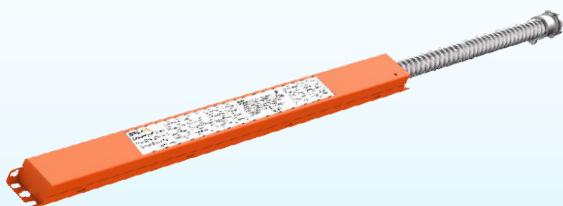

LED-EMB-25W-HV-0/10V

Emergency Backup for all sizes

FIXTURE, TRIM, & ACCESSORY

Trim Model	Description
SLDSK-5R-TRIM-BLK	Black 5" Round Trim
SLDSK-5R-TRIM-BRZ	Bronze 5" Round Trim
SLDSK-5R-TRIM-BNI	Brushed Nickel 5" Round Trim
SLDSK-7R-TRIM-BLK	Black 7" Round Trim
SLDSK-7R-TRIM-BRZ	Bronze 7" Round Trim
SLDSK-7R-TRIM-BNI	Brushed Nickel 7" Round Trim
SLDSK-12R-TRIM-BLK	Black 12" Round Trim
SLDSK-12R-TRIM-BRZ	Bronze 12" Round Trim
SLDSK-12R-TRIM-BNI	Brushed Nickel 12" Round Trim
SLDSK-5SQ-TRIM-BLK	Black 5" Square Trim
SLDSK-5SQ-TRIM-BRZ	Bronze 5" Square Trim
SLDSK-5SQ-TRIM-BNI	Brushed Nickel 5" Square Trim
SLDSK-7SQ-TRIM-BLK	Black 7" Square Trim
SLDSK-7SQ-TRIM-BRZ	Bronze 7" Square Trim
SLDSK-7SQ-TRIM-BNI	Brushed Nickel 7" Square Trim
SLDSK-12SQ-TRIM-BLK	Black 12" Square Trim
SLDSK-12SQ-TRIM-BRZ	Bronze 12" Square Trim
SLDSK-12SQ-TRIM-BNI	Brushed Nickel 12" Square Trim

Accessory Model	Description
SLDSK-4"-RK	4" Recessed Can Converter
SLDSK-6"-RK	6" Recessed Can Converter
SLDSKR-7-EMB	7" Round EM BACKUP
SLDSKR-7-EMB-EMPTY	7" Round EM BACKUP Empty Body
SLDSKR-7-EMB-UNV	7" Round EM BACKUP for ALL Models
SLDSKR-7-EMB-EMPTY-UNV	7" Round BACKUP Empty Body for ALL Models
SLDSKR-12-EMB-UNV	12" Round EM BACKUP for ALL Models
SLDSKR-12-EMB-EMPTY-UNV	12" Round BACKUP Empty Body for ALL Models
LED-EMB-25W-HV-0/10V	Emergency Backup for all sizes

DIMMER COMPATIBILITY

Brand	Series	Model	Load	Dimmability
Lutron	Ariadni	AYCL-153P	150W	OK
	Diva	DV-600PR	600W	OK
	Diva	DVCL-153P	150W	OK
	Maestro	MACL-153MH	600W	OK
	Maestro Wireless	MRF2-6CL	150W	OK
	Rotary	D-600P	600W	OK
	Electronic(ELV)	NTElv-300P	600W	OK
	Skylark	S-600P	600W	OK
	Skylark Contour	CT-600P	600W	OK
	Skylark Contour	CTCL-153P	150W	OK
	Toggle	TG-600P	600W	OK
Toggle	TGCL-153P	150W	OK	
Leviton	Sureslide	6633	600W	OK
	Sureslide Decora	6674	600W	OK
	Trimatron	6672	600W	OK
	Sureslide	6613	600W	OK
Legrand	Adorne	DLV703	700W	OK
	Harmony	H703PTW	700W	OK
Cooper	Aspire	9530	1000W	OK
	Devine	DAL03P	300W	OK

OPERATION MANUAL

EMERGENCY BATTERY BACKUP



TOOLS AND MATERIALS REQUIRED:



Phillips Screwdriver



Wire Cutters



Pliers



Wrench

Wiring supplies as required by the Canadian Electrical Code and/or the Quebec Electrical code



SAFETY RECOMMENDATIONS

- 1.The lighting shall be mounted at a height of maximum 4.0m.
- 2.Do not use outdoors.
- 3.Do not mount near gas or electric heaters.Do not let power supply cords touch hot surfaces.
- 4.Use caution when changing batteries -TURN ALL POWER OFF, BOTH WALL SWITCH AND MAINS POWER! Use only designated battery as supplied with original unit or as listed for use with this product.Dispose of old battery in designated disposal location.
- 5.Equipment should be mounted in locations and at heights where it will not be subjected to tampering by unauthorized personnel.
- 6.This product is designed for use with the 7"Round or 7" Square Blink Pop "n" lock' series lighting. Must not be used with any other fixture.
- 7.Do not use this product for other than intended use.

ALL servicing should be performed by professional personnel.

SAVE THESE INSTRUCTIONS

Test Button and LED Indicator

Test Button functions

1.While main power is on:

A quick press of the test button,(<3seconds), simulates the"main power outage "or emergency mode".

The light fixture will come on in this case -it will be running on battery power.

Pressing test button for 3- 6 seconds puts the unit into the monthly self-check routine(approx.3 minutes run time).

Press test button again anytime to stop the routine.

As the system runs its check on the battery power and circuit connections,the LED indicator will flash green@1 cycle/second.

Pressing test button for >6seconds puts the unit into the annual self-check routine.(up to 90 minutes run time-

Note: The system will completely discharge the battery during this routine).

Press test button again anytime to stop the routine.

As the system runs its more detailed annual check on the battery power and circuit connections, the LED indicator will quickly flash green@3 cycle/second .

2.While in Emergency Status (mains power outage):

Pressing test button for <6seconds shuts off the unit .press again to turn it back on .

Pressing test button for <6seconds completely shuts off emergency output.In this state, the system will not function unless the mains power is reset.

LED indicator colors/functions

Red:Battery is charging.

Green:Battery at full charge.

Yellow:Check system- possible battery replacement needed or system maintenance required.

Green Flashing:Monthly or annual checking mode is running.

Off:Indicates a power outage .when the Battery Backup unit is in Emergency Mode the LED indicator will be Off.

Minimum charge time :24hours.

Technical Data

Model:

Light Fixture Wattage:

Input Voltage:

Input Current:

Installation Specifications: 3" or 4" Junction box

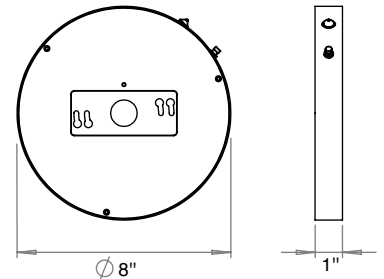
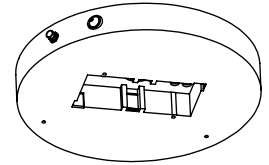

Option #1: slim surface light

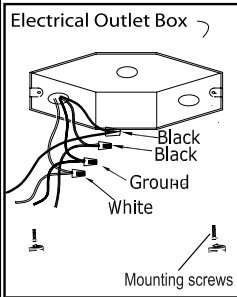

Step 1) Turn off/Disconnect power at Circuit breaker. Typical junction box wiring has only white&black switched wires controlled by wall switch for on/off or dimming. Ensure the junction box has an additional set of UNSWITCHED WIRES (continuous)main power wires available.If necessary, add these wires as shown.(Label these additional wires so correct connections can be made)

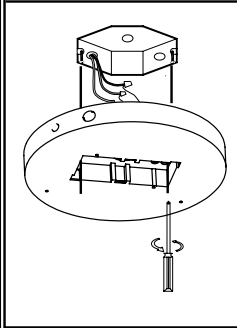

Step 2) Screw the Emergency Backup unit up into the junction box using the 2X8/32 screws provided.Then using the wire unstr provided,connect the three (3) cables available for connection into junction box
 a.Connect the "Switched Line" to the black switched power cable coming from the junction box.
 b.Connect the "Continuous Mains Power" from the battery backup box to the continuous mains black wire from the junction box.
 c.Connect the "Neutral" white wire from the battery backup together with the other two neutral white wires

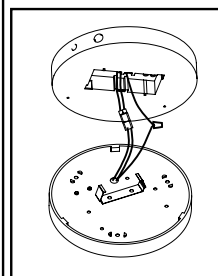

Step 3) Make electrical connections from the Blnk LED lighting fixture with the battery backup.
 a.Use the orange connector already supplied and affixed to the unit.
 b.Be sure to connect the ground wire coming from the lighting fixture.

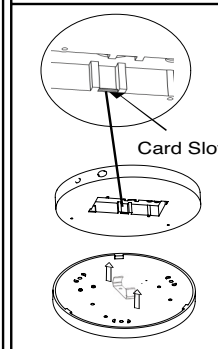

Step 4) Pop n lock into place
 a.Feed all wires up into the battery backup box and raise the lighting fixture up to the ceiling.
 b.Align the edge of the fixture with the ball bearings on the mounting bracket and Pop n lock into place.
 c.Thank you installing safely.Enjoy your Emergency Lighting system!

Option #2: slim surface light (CCT)

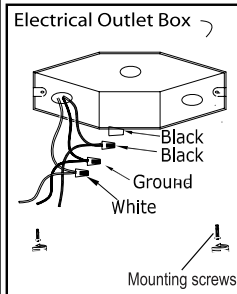

Step 1) Turn off/Disconnect power at Circuit breaker. Typical junction box wiring has only white&black switched wires controlled by wall switch for on/off or dimming. Ensure the junction box has an additional set of UNSWITCHED WIRES (continuous)main power wires available.If necessary, add these wires as shown.(Label these additional wires so correct connections can be made)

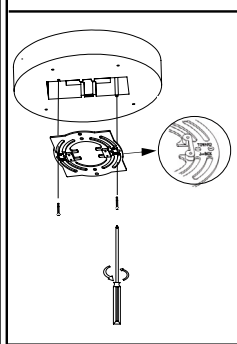

Step 2) Screw the Emergency Backup unit up into the junction box using the 2X8/32 screws provided.Then using the wire unstr provided,connect the three (3) cables available for connection into junction box
 a.Connect the "Switched Line" to the black switched power cable coming from the junction box.
 b.Connect the "Continuous Mains Power" from the battery backup box to the continuous mains black wire from the junction box.
 c.Connect the "Neutral" white wire from the battery backup together with the other two neutral white wires coming

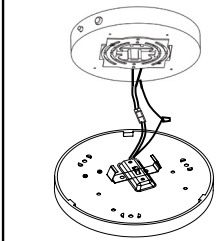

Step 3) Make electrical connections from the Blnk LED lighting fixture with the battery backup.
 a.Use the orange connector already supplied and affixed to the unit.
 b.Be sure to connect the ground wire coming from the lighting fixture.

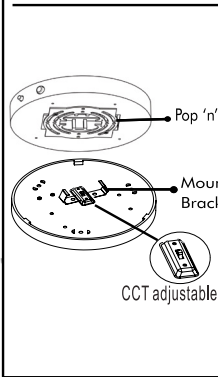

Step 4) Pop n lock into place
 a.Feed all wires up into the battery backup box and raise the lighting fixture up to the ceiling.
 b.Align the edge of the fixture with the ball bearings on the mounting bracket and Pop n lock into place.
 c.Thank you installing safely.Enjoy your Emergency Lighting system!

FOR CONTINUOUS POWER APPLICATIONS

If the battery backup is used for 1.A system with 24/7 lighting OR 2.As a dedicated Emergency Lighting only,(light off in normal condition) Only continuous UNSWITCHED power is needed at the junction box-no need for switched wires.

Option 1

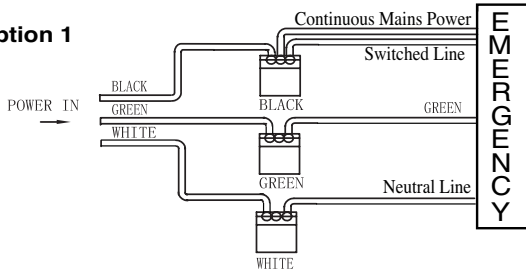

For Option 1 above as 24/7 lighting:Connect the two black wires(labeled as "Continuous Mains Power" and "Switched Line") from the battery backup to the black mains wire in the junction box and Connect the white ("Neutral")to white from the box wires (image below).

Then screw the Emergency Backup unit up into the junction box using the 2x 8/32 screws provided the go to STEP4

Option 2

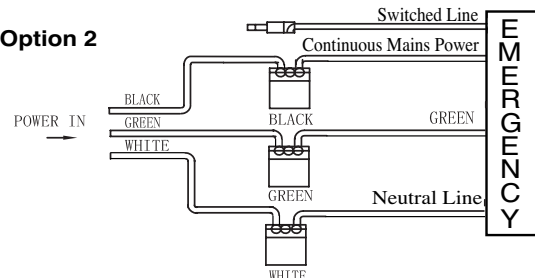

For Option2 above as dedicated Emergency Light only: Connect the black wire (labeled as "continuous Mains Power")from the battery backup to the black mains wire in the junction box and Connect white("Neutral")to white from the battery backup fixture to junction box wires (image below).Screw wire nut over the "Switched Line" and leave unconnected .Then screw the Emergency Backup unit up into the junction box using the 2x 8/32 screws provided the go to STEP4.