

LED Semi-Cutoff Wall Pack Instructions

APPLICATION

Available in industrial lighting, landscape lighting, courtyard, building, hotel, building exterior, etc.

CAUTION

1. Can not use an electric generator to test the LED lamp.
2. Please abide by related country, regional and local law and regulations when to install the fixture.
3. Please do not install the fixture when raining to lower the risk of electric shock and avoid failure.

NOTE

1. To avoid possibility of electrical shock or fire, the installation personnel must have professional electrical knowledge.
2. Wear gloves to avoid injury during installation.
3. If any smoke or spark of the wire occurs, please turn off the power immediately and notify relevant personnel.

INSTALLATION I

1. Take out the light, loosen the screws on the cover and take apart the fixture with a screwdriver. Pull off the quick connect terminal (Figure 1-1A & 1-1B)

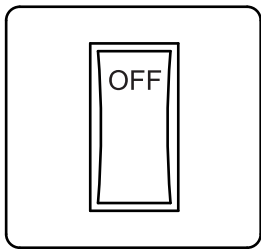

1. Turn off the power

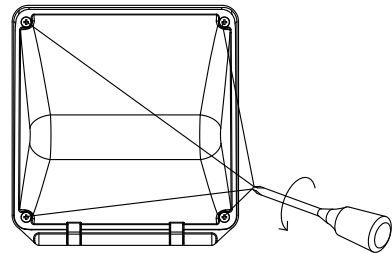

2. Unscrew the 4 screws of the lamp cover and the rubber sleeve on the screw must not be discarded.

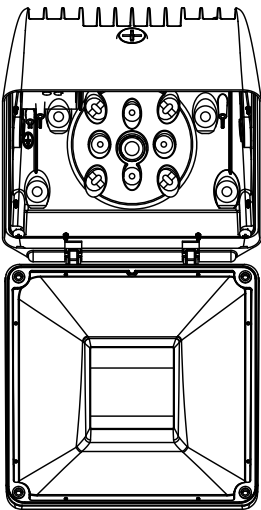

3. Remove the lamp cover, careful not to damage the lamp cover.

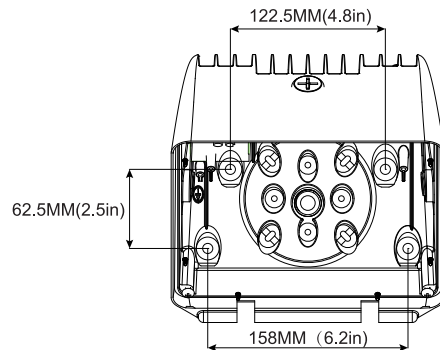

4. Make mounting holes on the wall according to the size shown in the picture. Use an electric drill to drill through the mounting holes on the lamp.

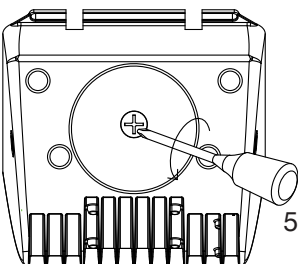

5. Remove the 1/2" plug with a screwdriver

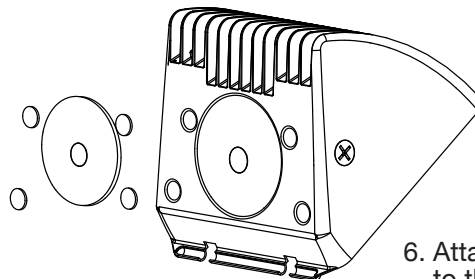

6. Attach the EVA pad to the relevant position on the back of the lamp.

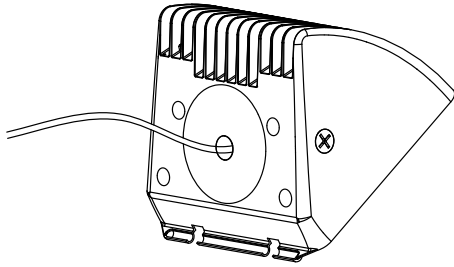

7. Run the power line through the hole

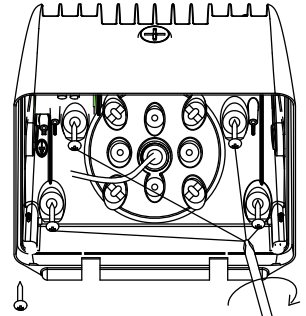

8. Screw the lamp onto the mounting hole

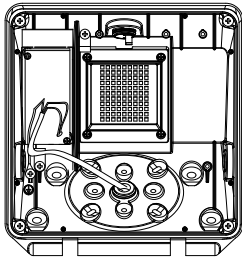

9. Connect the wires correctly, make sure wires are protected. Pull out the wire connected to photocell if photocell function is not demanded.

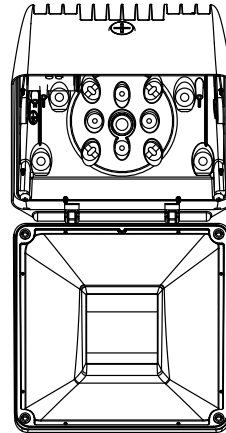

10. Assemble the lamp cover back to the lamp

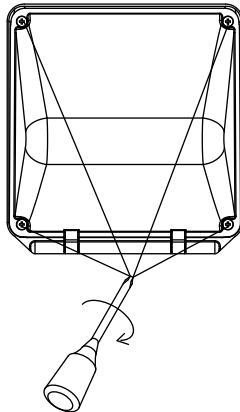

11. Fasten the lamp cover to the lamp body with kit rubber ring.

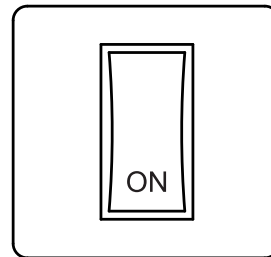

12. Installation is finished and turn the lamp on

INSTALLATION II

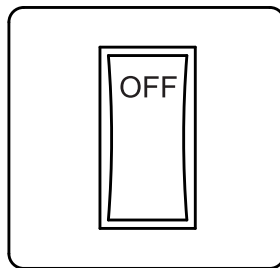

1. Turn off the power

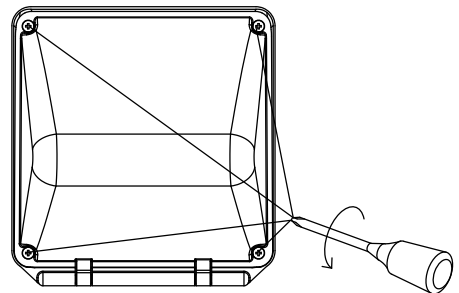

2. Unscrew the 4 screws of the lamp cover and the rubber sleeve on the screw must be discarded

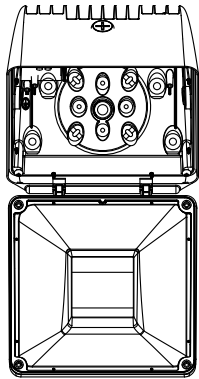

3. Remove the lamp cover, take care not to damage the lamp cover.

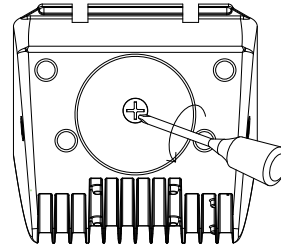

4. Remove the 1/2" plug with a screwdriver

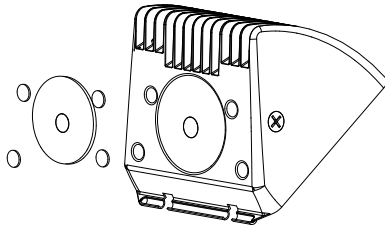

5. Attach the EVA pad to the relevant position on the back of the lamp.

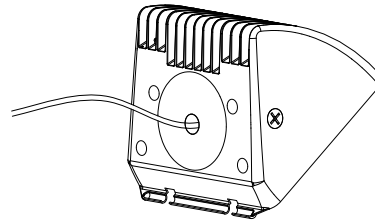

6. Run the power line through the hole

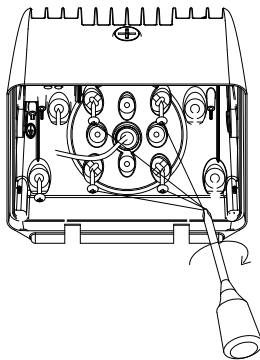

7. Drill the mounting holes of the mounting plate with an electric drill and screw the lamp onto the mounting plate.

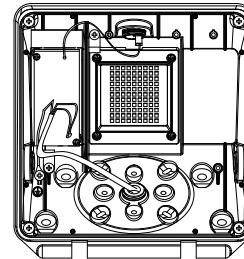

8. Connect the wires correctly and protected correctly. Pull out the wire connected to photocell if photocell function is not demanded.

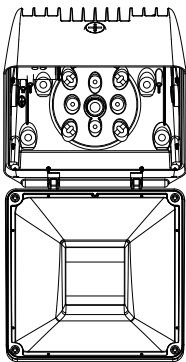

9. Assemble the lamp cover back to the lamp.

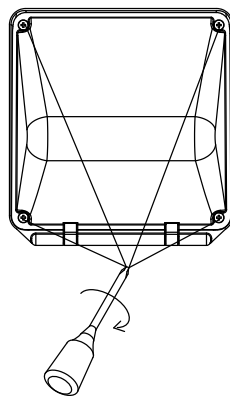

10. Fasten the lamp cover to the lamp body with kit rubber ring.

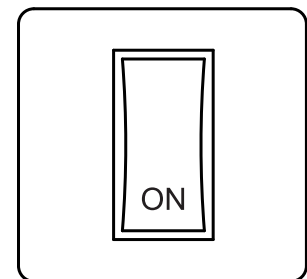

11. Installation is complete to turn on the power