

LED Wall Sconce Cylinder Instructions



WARNING

PLEASE READ ALL INSTRUCTIONS BEFORE ATTEMPTING INSTALLATION

SAFETY: This fixture must be wired in accordance with the national electrical code and applicable local codes and ordinances. Proper grounding is required to insure personal safety. Carefully observe the grounding procedure under installation section. All work should be done by a qualified electrician.

- RISK OF ELECTRIC SHOCK - Disconnect power at fuse or circuit breaker before installing or servicing.
- RISK OF PERSONAL INJURY - Fixture may become damaged and/or unstable if not installed properly. Tighten all fixture components to their recommended torque values.

WARNING: Make certain power is OFF before starting installation or attempting any maintenance.

INSTALLATION

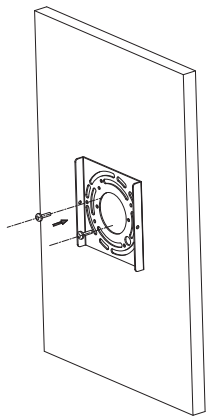
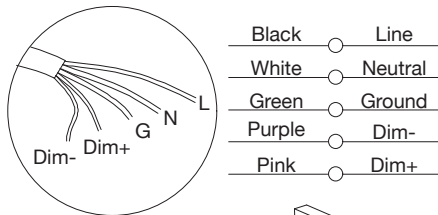

Fig 1

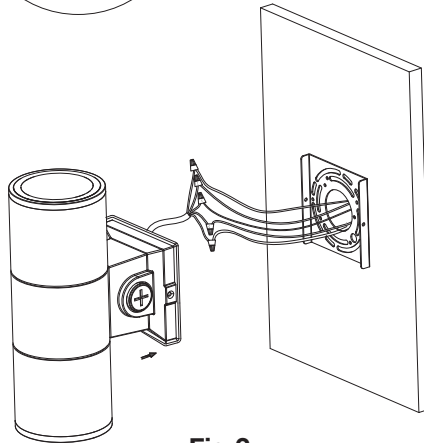

Fig 2

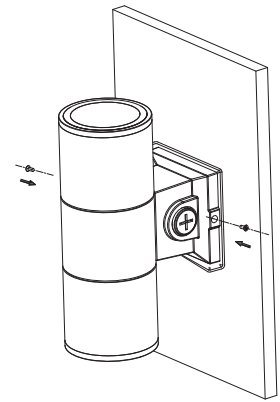

Fig 3

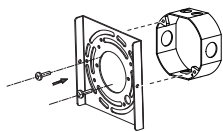
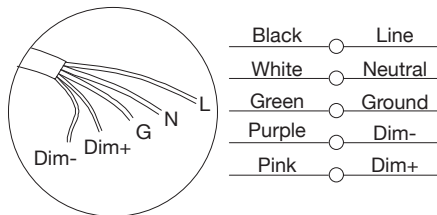

Fig 4

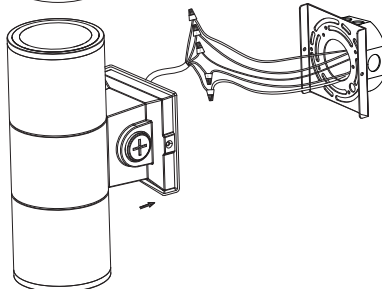

Fig 5

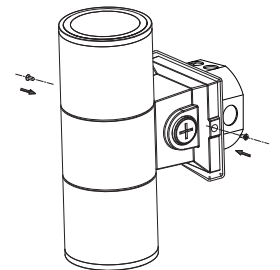

Fig 6

WATTAGE & CCT SELECTABLE GUIDANCE

Factory Default Setting:
Watt: 10W/20W/35W CCT: 5000K Photocell: ON

