

5" Trimless Surface Mount Instructions



INSTRUCTIONS PERTAINING TO RISK OF FIRE OR INJURY TO PEOPLE
READ ALL INSTRUCTIONS

IMPORTANT SAFETY INSTRUCTIONS
SAVE THESE INSTRUCTIONS

PREPERATION

Read all instructions before installing fixtures. Retain for future reference. This fixture must be installed in accordance with the applicable installation code, by a person familiar with the construction or operation of the product and the hazards involved.

PRE-INSTALLATION

- Turn off electrical power before starting installation of light fixture.
- CAUTION: RISK OF FIRE. Consult a qualified electrician to ensure correct brand circuit conductor.
- For external use only. Recommend applying waterproof silicone to seal around trim and ceiling.

TOOLS AND MATERIALS REQUIRED



Phillips Screwdriver



Wirecutters



Pliers



Wrench

PACKAGE CONTENTS

PART	DESCRIPTION	QTY	NOTE
A	Slim Flush Mount Light	1	
B	Mounting Screws	2	
C	Wire Nut	3	
D	Clip	2	Optional
E	Mounting Plate	1	
F	E26 Lamp Holder	1	Optional

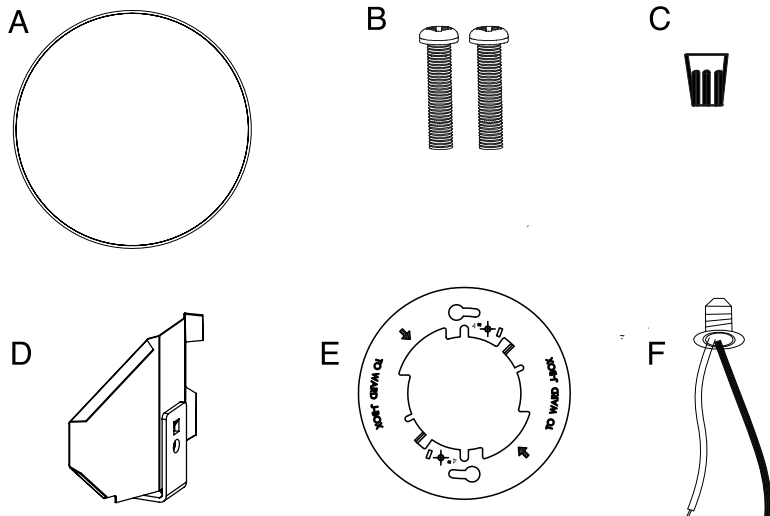

INSTALLATION:

OPTION 1 - FLUSH MOUNT

STEP 1: Prior to installation, install mounting plate into electrical outlet box with mounting screws. Drive screws completely to the end of the junction box.

STEP 2: Connect supply wires to wires on the fixture with wire nuts, or push wires into Quick Connector. Connect white to white, black to black and copper to copper wire as grounding connection.

STEP 3: Complete installation by pushing the fixture into the mounting plate.

Electrical Outlet Box

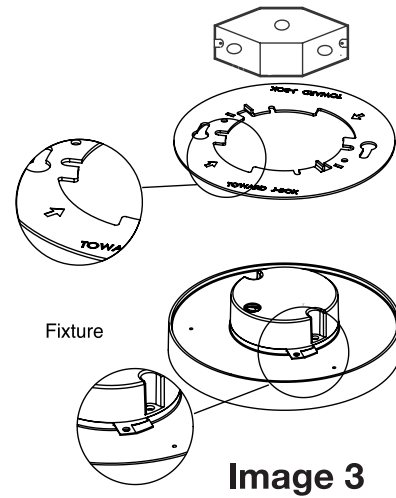
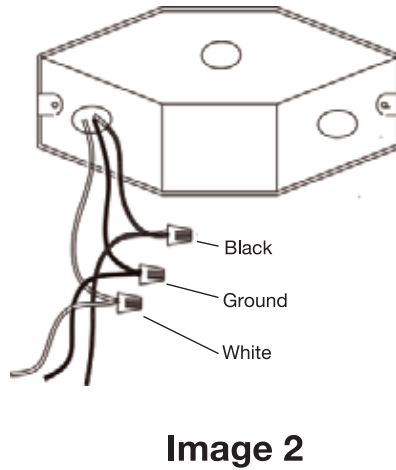
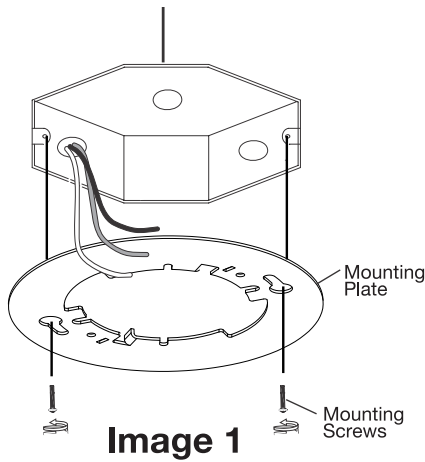

OPTION 2 - RETORIFIT RECESSED CAN

STEP 1: Insert wires into Quick Connector. Black to Black and White to White. Attach ground wire to ground screw in recessed can.

STEP 2: Place E26 lamp holder into socket base.

STEP 3: Connect quick connectors and tuck all wires into recessed can. Squeeze springs and push up into recessed can.

