



OUTDOOR



RESIDENTIAL



INDUSTRIAL



COMMERCIAL

**Warehouse Locations**

- Bell, CA (HQ)
- Dallas, TX
- S. Windsor, CT
- Midland, NC
- Freehold, NJ
- Cincinnati, OH

# About EnVision LED Lighting

Established in 2010, EnVision LED Lighting, Inc. is a Los Angeles based LED lighting leader that provides the market with an array of LED lighting products. Our series of high efficiency, low energy consuming LED products have been skillfully developed by our engineers to suit a range of clients both in the residential and commercial application.

EnVision LED's objective is very simple; to provide superior LED lighting products and service at the highest level of quality and performance in the industry. Our USA team of lighting professionals that strive to develop innovative techniques to manufacture the most efficient LED lighting products. This allows users to save money and create a brighter future for the environment.

## What's New?

**Customization:** EnVision has always been a believer in adding controls to our fixtures. Now we have added the cost on our price sheet for easier quoting.

**10 Year Warranty:** EnVision is now offering a 10 year optional warranty on most of our products.

**Freight Allowed:** EnVision has updated their Free Freight Allowed policy.

Best of all, our new catalog features hundreds of new SKUs that are now available. Check out **"NEW"** throughout the catalog!

Please contact EnVision LED or your local rep for more information on what's new!

Our new facility allows us to ship all in stock orders within 24-48 hours. Reach out to us with special ship requests or hard deadlines and we will do our best to make it happen.

## EnVision LED Affiliated Organizations



### American Lighting Association

EnVision LED Lighting Inc is a proud member of ALA.



### Safety Certification Listings

All EnVisionLED products carry either a UL or ETL nationally recognized safety certification listing to ensure the highest level of safety.



### Performance Certification Listing

Products which carry DLC qualified listings are shown in each product specification table.



### Energy Star

Products which carry Energy Star qualified listings are shown in each product specification table.



### JA8 Title 24 Compliance

Look for the JA8 icon for products that have been qualified and listed in California's JA8 MAEDBS database provided to help comply with California Title 24 requirements.

## EnVision LED Product Features



### Selected Color Temperature

A specification for white light sources used to describe the dominant color tone along the dimension from warm (yellows and reds) to cool (blue).



### Select-N-Switch Technology

EnVisions technology which allows you to choose your desired lumen and CCT. Just Select-N-Switch!"



### Twist-C Control

EnVision's new Twist-C technology allows for an easy sensor installation without any wiring necessary! Purchase any Twist-C control ready fixture and simply twist the sensor into the fixture to activate. (Remote model#: HB03R is required for set-up).



EnVision  
CONNECT

### EnVision Connect App

Download our new smart home app on your favorite Android or Apple devices to connect our Bluetooth enabled fixtures and sensors!

# Table of Contents

<b>NEW</b> Wall Packs .....	1-4
<b>NEW</b> Area Lights .....	5-10
<b>NEW</b> Cylinders & Wall Sconces .....	11
<b>NEW</b> Tenon Mounts for Posts .....	12
<b>NEW</b> Area Lights .....	13-15
<b>NEW</b> Sports Light .....	16
Bollard Light .....	17
Aquarium Lights / Grow Lights .....	18
<b>NEW</b> Linear Highbay .....	19-20
UFO Highbay .....	21
Canopy Lights .....	22-23
<b>NEW</b> Panels .....	24-27
Troffers .....	28
<b>NEW</b> Tubes .....	29-30
<b>NEW</b> Linear Downlights .....	31-32
<b>NEW</b> Linear .....	33
<b>NEW</b> Strips .....	34
<b>NEW</b> Wraps .....	35
<b>NEW</b> Vapor Tights .....	36
1" Mini Downlights .....	37
Trimless Downlights .....	38
<b>NEW</b> Canless Downlights .....	39-48
EXT Snaptrim Downlight Accessories .....	49
<b>NEW</b> Commercial Downlights .....	50-51
J-Box Downlights .....	52
<b>NEW</b> Smart Downlights .....	53
<b>NEW</b> Retrofit Downlights .....	54-56
<b>NEW</b> LED Cans .....	57
<b>NEW</b> Surface Mounts .....	58-64
Track Lights .....	65
<b>NEW</b> Puck Lights .....	66
<b>NEW</b> Undercabinet Fixtures .....	67-68
Step Lights .....	69
<b>NEW</b> Emergency Exit Signs .....	70-71
Corn Bulbs .....	72
PL Lamps .....	73
Filament Bulbs .....	74
<b>NEW</b> LED Bulbs .....	75-77
LED Lightstrips .....	78-79
<b>NEW</b> Magnetic & Electronic Transformers .....	80-81
Sensors .....	82
<b>NEW</b> Emergency Battery Backups .....	83
Displays .....	84



### Mini Wall Pack: M-Line - w/ Photocell

- Frosted polycarbonate lens will not yellow over time
- Photocell is optional and can be disconnected

#### 3-CCT Select



Model	Voltage	Watts	Lumens	Color
LED-WPM-20W-TRI-F-BZ-PC	120-277V	20w	2,860	50/40/30k

\*Custom finishes include white, black, gray, and custom. 7 Day lead time required. Please contact us for pricing based on qty. for custom finish orders.

### Small Body Wall Pack: S-Line - w/ Photocell

- Frosted polycarbonate lens will not yellow over time
- Photocell is optional and can be disconnected

#### 3-CCT Select



Model	Voltage	Watts	Lumens	Color
LED-WPS-29W-TRI-BZ-PC	120-277V	29w	3,799	50/40/30k

#### Single CCT

Model	Voltage	Watts	Lumens	Color
LED-WPS-60W-50K-BZ-PC	120-277V	60w	7,860	5000k

\*Custom finishes include white, black, gray, and custom. 7 Day lead time required. Please contact us for pricing based on qty. for custom finish orders.



Final Production

### Regular Wall Pack: Full-Line

- Thick glass lens wall pack will not yellow over time
- Fully weatherproof IP67-rated housing

#### 3-CCT & 5-Power Select w/ Photocell



Model	Voltage	Watts	Lumens	Color
LED-WPF-5P60-TRI-BZ-PC	120/277V	60/50/40/30/20w	140 lm/w	50/40/30k
LED-WPF-5P120-TRI-BZ-PC	120/277V	120/100/80/60/40w	140 lm/w	50/40/30k

#### Single CCT

Model	Voltage	Watts	Lumens	Color
LED-WPF-40W-40K-BZ	120/277V	40w	5,600	4000k
LED-WPF-80W-40K-BZ	120/277V	80w	11,200	4000k
LED-WPF-80W-50K-BZ	120/277V	80w	11,200	5000k
LED-WPF-120W-40K-BZ	120/277V	120w	16,800	4000k

Pre-Installed Accessory Model	Description
Add '-EMB' to model #	Emergency Backup (Internal 8W)
Add '-BMS' to model #	S-BMS-EXT-1: Bi Level Motion + Daylight Sensor
Add '-BMS1BT' to model #	S-BMS-EXT-1-BT: Bi Level Motion + Daylight Sensor W/ Bluetooth Control (ENVISION CONNECT APP)
Add: 20KV to model#	SG-20KV-UNV: 20KV Surge Protector
Add: -HV to model#	347-480V Step Down Transformer



Final Production

5P60		5P120	
WATT	LUMENS	WATT	LUMENS
20	2,300	40	5,600
30	4,200	60	8,400
40	5,600	80	11,200
50	7,000	100	14,000
60	8,400	120	16,800



### Slim Wall Pack: SL-Line

- Thick glass lens wall pack will not yellow over time
- Fully weatherproof IP67-rated housing

#### 3-CCT & 5-Power Select w/ Photocell



Model	Voltage	Watts	Lumens	Color
LED-WPF-SL-3P60-TRI-BZ-UNV-PC	120-277V	60/40/30w	130 lm/w	50/40/30k
LED-WPF-SL-3P120-TRI-BZ-UNV-PC	120-277V	120/100/80w	130 lm/w	50/40/30k
LED-WPF-SL-3P60-TRI-BZ-HV-PC	277-480V	60/40/30w	130 lm/w	50/40/30k
LED-WPF-SL-3P120-TRI-BZ-HV-PC	277-480V	120/100/80w	130 lm/w	50/40/30k

\*Custom finishes include white, black, gray, and custom. 7 Day lead time required. Please contact us for pricing based on qty. for custom finish orders.

Accessory Model	Description
WPF-SHIELD	Cut Off Shield for WPF Wall Packs
WPF-WG	Wire Guard for WPF Wall Packs
WPF-SL-SHIELD	Cut Off Shield for WPF-SL Wall Packs

Pre-Installed Accessory Model	Description
Add '-EMB' to model #	Emergency Backup (Internal 8W)
Add '-BMS' to model #	Bi-Level Motion + Daylight Sensor
Add '-BMS1' to model #	S-BMS-EXT-1: Bi Level Motion + Daylight Sensor
Add '-BMS1BT' to model #	S-BMS-EXT-1-BT: Bi Level Motion + Daylight Sensor W/ Bluetooth Control (ENVISION CONNECT APP)
Add: 20KV to model#	SG-20KV-UNV: 20KV Surge Protector
Add: -HV to model#	347-480V Step Down Transformer



WATT	LUMENS	WATT	LUMENS
30	3,900	80	10,400
40	5,200	100	13,000
60	7,800	120	15,600



Emergency Back-Up

Bi-Level Motion



WATT	LUMENS
40	4,890
60	8,280
80	10,875

### Rotating Wall Pack: R-Line

- Optical lens on individual LED chips, full forward throw light
- Upgraded housing design includes back cover for more installation applications
- Dark sky compliant
- Full 360° rotating in any angle
- Toolless rotation and locking system

#### Single Module



Model	Voltage	Watts	Lumens	Color
LED-WPROT2-25WS-TRI-BZ	120-277V	25w	3,600	50/40/30k
LED-WPROT2-40WS-30K-BZ	120-277V	40w	4,890	3000k
LED-WPROT2-40WS-40K-BZ	120-277V	40w	4,890	4000k
LED-WPROT2-40WS-50K-BZ	120-277V	40w	4,890	5000k

\*Custom finishes include white, black, gray, and custom. 7 Day lead time required. Please contact us for pricing based on qty. for custom finish orders.

#### Double Module

Model	Voltage	Watts	Lumens	Color
LED-WPROT2-3P80WD-TRI-BZ	120-277V	80/60/40w	130 lm/w	50/40/30k
LED-WPROT2-60WD-TRI-BZ	120-277V	60w	8,280	50/40/30k
LED-WPROT2-80WD-30K-BZ	120-277V	80w	10,875	3000k
LED-WPROT2-80WD-40K-BZ	120-277V	80w	10,875	4000k
LED-WPROT2-80WD-50K-BZ	120-277V	80w	10,875	5000k

\*Custom finishes include white, black, gray, and custom. 7 Day lead time required. Please contact us for pricing based on qty. for custom finish orders.

NEW

Accessory Model	Description
WPROT-SHIELD	Wall Pack: R-Line Shield

Pre-Installed Accessory Model	Description
Add '-EMB' to model #	Emergency Backup (Internal 8W)
Add '-PC' to model #	Button Photocell
Add '-BMS' to model #	S-BMS-EXT-1: Bi Level Motion + Daylight Sensor
Add '-BMS1BT' to model #	S-BMS-EXT-1-BT: Bi Level Motion + Daylight Sensor W/ Bluetooth Control (ENVISION CONNECT APP)



WATT	LUMENS
30	4,350
40	5,800
50	7,250
60	8,100
70	9,450
80	13,882

### Full Cut Off Wall Packs Adjustable: AFC-Line

- Optical lens on individual LED chips, full forward throw light
- Dark sky compliant
- Adjustable up to 90° easy lock system
- Slim and architectural IP67-rated housing

#### 3-CCT & 3-Power Select



NEW  
NEW  
NEW  
NEW

Model	Voltage	Watts	Lumens	Color
LED-WPFC-ADJ-30W-TRI-BZ	120-277V	30W	4,050	50/40/30k
LED-WPFC-ADJ-3P50W-TRI-BZ	120-277V	50/40/30W	145 lm/w	50/40/30k
LED-WPFC-ADJ-3P50W-TRI-BL	120-277V	50/40/30W	145 lm/w	50/40/30k
LED-WPFC-ADJ-3P50W-TRI-WH	120-277V	50/40/30W	145 lm/w	50/40/30k
LED-WPFC-ADJ-3P80W-TRI-BZ	120-277V	80/70/60W	145 lm/w	50/40/30k
LED-WPFC-ADJ-3P80W-TRI-BL	120-277V	80/70/60W	145 lm/w	50/40/30k
LED-WPFC-ADJ-3P80W-TRI-WH	120-277V	80/70/60W	145 lm/w	50/40/30k

#### Single CCT

Model	Voltage	Watts	Lumens	Color
LED-WPFC-ADJ-55W-50K-BZ	120-277V	55w	6,150	5000k

Pre-Installed Accessory Model	Description
Add '-EMB' to model #	Emergency Backup (Internal 8W)
Add '-PC' to model #	Button Photocell
Add '-BMS' to model #	S-BMS-EXT-1: Bi Level Motion + Daylight Sensor
Add '-BMS1BT' to model #	S-BMS-EXT-1-BT: Bi Level Motion + Daylight Sensor W/ Bluetooth Control (ENVISION CONNECT APP)



60W



120W



Bi-Level Motion



Emergency Back-Up



Photocell

### Full-Cutoff Wall Pack: Flat-FC Line

- Durable die-cast aluminum housing with integrated heatsink
- Optical lens on individual LED chips for full forward throw light
- Dark sky compliant
- Photocell is optional and can be disconnected

3-CCT & 5-Power Select w/ Photocell



Model	Voltage	Watts	Lumens	Color
LED-WPFC-FL-5P60W-TRI-BZ-PC	120-277V	60/50/40/30/20W	145 lm/w	50/40/30k
LED-WPFC-FL-5P60W-TRI-BL-PC	120-277V	60/50/40/30/20W	145 lm/w	50/40/30k
LED-WPFC-FL-5P120W-TRI-BZ-PC	120-277V	120/110/100/90/80W	145 lm/w	50/40/30k
LED-WPFC-FL-5P120W-TRI-BL-PC	120-277V	120/110/100/90/80W	145 lm/w	50/40/30k



Pre-Installed Accessory Model	Description
Add '-EMB' to model #	Emergency Backup (Internal 20W)
Add '-PC' to model #	Button Photocell
Add '-BMS' to model #	S-BMS-EXT-1: Bi Level Motion + Daylight Sensor
Add '-BMS1BT' to model #	S-BMS-EXT-1-BT: Bi Level Motion + Daylight Sensor w/ Bluetooth Control (ENVISION CONNECT APP)

WATT	LUMENS	WATT	LUMENS
20	2,900	80	11,600
30	4,350	90	13,050
40	5,800	100	14,500
50	7,250	110	15,950
60	8,700	120	17,400

### Full-Cutoff Wall Pack: FC-Line

- Durable die-cast aluminum housing with integrated heatsink
- Optical lens on individual LED chips for full forward throw light
- Dark sky compliant
- Photocell is optional and can be disconnected

3-CCT & 5-Power Select w/ Photocell



Model	Voltage	Watts	Lumens	Color
LED-WPFC-5P80-TRI-BZ-PC	120-277V	80/64/48/32/16w	145 lm/w	50/40/30k
LED-WPFC-5P80-TRI-BL-PC	120-277V	80/64/48/32/16w	145 lm/w	50/40/30k
LED-WPFC-5P80-TRI-WH-PC	120-277V	80/64/48/32/16w	145 lm/w	50/40/30k
LED-WPFC-5P80-TRI-BZ-HV-PC	277-480V	80/64/48/32/16w	145 lm/w	50/40/30k
LED-WPFC-5P150-TRI-BZ-PC	120-277V	150/120/90/60/30w	145 lm/w	50/40/30k



NEW

NEW

\*Custom finishes include white, black, gray, and custom. 7 Day lead time required. Please contact us for pricing based on qty. for custom finish orders.

Pre-Installed Accessory Model	Description
Add: -T4 to Model #	Factory Installed Type IV Optic (80W: 1 PC) (150W: 2 PCs)
Add: -T5 to Model #	Factory Installed Type V Optic (80W: 1 PC) (150W: 2 PCs)
WPFC-T-II	Wall Pack: FC-Line: Type II Optics Lens Req'd: (80W: 1 PC) (150W: 2 PCs)
WPFC-T-IV	Wall Pack: FC-Line: Type V Optics Lens Req'd: (80W: 1 PC) 150W: 2 PCs)
Add '-BMS' to model #	S-BMS-EXT-1: Bi Level Motion + Daylight Sensor
Add '-BMS1BT' to model #	S-BMS-EXT-1-BT: Bi Level Motion + Daylight Sensor w/ Bluetooth Control (ENVISION CONNECT APP)



WATT	LUMENS	WATT	LUMENS
16	2,320	64	9,280
30	4,350	80	11,600
32	4,640	90	13,050
48	6,960	120	17,400
60	8,700	150	21,750



Emergency Back-Up



Photocell



Optic Lens

### Slim Wall Pack: EGG-Line

- Die-cast aluminum housing
- Polycarbonate lens and mirror reflector
- Lithium battery 4.8V 1800mAh
- Backup time up to 90 min.
- EMB- Emergency Back-up
- Emergency mode- 690 Lumens

3-CCT Select



Model	Voltage	Watts	Lumens	Color
LED-WPE-15W-TRI-PC-BZ	120-277V	15w	1950	50/40/30k
LED-WPE-15W-TRI-PC-BZ-EMB	120-277V	15w	1950	50/40/30k



\*Custom finishes include white, black, gray, and custom. 7 Day lead time required. Please contact us for pricing based on qty. for custom finish orders.





Downlight Application



Uplight Application

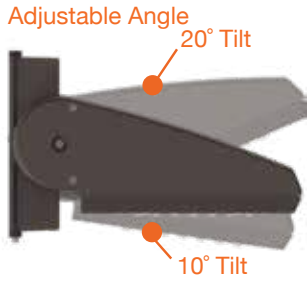

WATT	LUMENS
30	3,900
50	6,500
60	7,800
65	8,450
80	10,400
100	13,000



Bi-Level Motion

### ARCY-Line: Full Cut Off Wall Packs

- Optical lens on individual LED chips, full forward throw light
- Slim and architectural IP67-rated housing
- Dark sky compliant
- Adjustable up to 90° easy lock system
- Photocell is optional and can be disconnected

#### 3-CCT & 3-Power Select



Model	Voltage	Watts	Lumens	Color
LED-WPFC-ARC-3P65-TRI-BZ-PC	120-347V	65/50/30W	130 lm/w	50/40/30k
LED-WPFC-ARC-3P100-TRI-BZ-PC	120-347V	100/80/60W	130 lm/w	50/40/30k

Accessory Model	Description
WPFC-ARC-S-T-IV	Wall Pack: ARCY-Line Optic for 3P65
WPFC-ARC-M-T-IV	Wall Pack: ARCY-Line Optic for 3P100
WPFC-ARC-S-T-V	Wall Pack: ARCY-Line Optic for 3P65
WPFC-ARC-M-T-V	Wall Pack: ARCY-Line Optic for 3P100

Pre-Installed Accessory Model	Description
Add '-EMB' to model #	Emergency Backup (Internal 8W)
Add '-BMS' to model #	S-BMS-EXT-1: Bi Level Motion + Daylight Sensor
Add '-BMS1BT' to model #	S-BMS-EXT-1-BT: Bi Level Motion + Daylight Sensor W/ Bluetooth Control (ENVISION CONNECT APP)

### CIRCLE-Line: Semi-Circle Full Cut Off Wall Pack

- Optical lens on individual LED chips, full forward throw light
- Slim and architectural IP67-rated housing
- Dark sky compliant
- Photocell is optional and can be disconnected

#### 3-CCT & 3-Power Select



Model	Voltage	Watts	Lumens	Color
LED-WPFC-SC-3P80-TRI-BZ-PC	120-347V	80/64/48w	135 lm/w	50/40/30k

Pre-Installed Accessory Model	Description
Add '-EMB' to model #	Emergency Backup (Internal 8W)
Add '-BMS' to model #	S-BMS-EXT-1: Bi Level Motion + Daylight Sensor
Add '-BMS1BT' to model #	S-BMS-EXT-1-BT: Bi Level Motion + Daylight Sensor W/ Bluetooth Control (ENVISION CONNECT APP)



WATT	LUMENS
48	6,480
64	8,640
80	10,800

ETA: 02/2024



Emergency Back-Up



Bi-Level Motion

### CIRCLE-Line: Semi-Circle Up/Down Wall Pack

- Optical lens on individual LED chips, full forward throw light
- Slim and architectural IP67-rated housing
- Up and down light selectable
- Photocell is optional and can be disconnected

#### 3-CCT & 3-Power Select



Model	Voltage	Watts	Lumens	Color
LED-WPUD-SC-3P80-TRI-BZ-PC	120-347V	80/64/48w	130 lm/w	50/40/30k

Pre-Installed Accessory Model	Description
Add '-EMB' to model #	Emergency Backup (Internal 8W)
Add '-BMS' to model #	S-BMS-EXT-1: Bi Level Motion + Daylight Sensor
Add '-BMS1BT' to model #	S-BMS-EXT-1-BT: Bi Level Motion + Daylight Sensor W/ Bluetooth Control (ENVISION CONNECT APP)



ETA: 03/2024

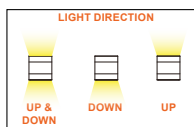

WATT	LUMENS
48	6,960
64	9,280
80	11,600



Emergency Back-Up



Bi-Level Motion

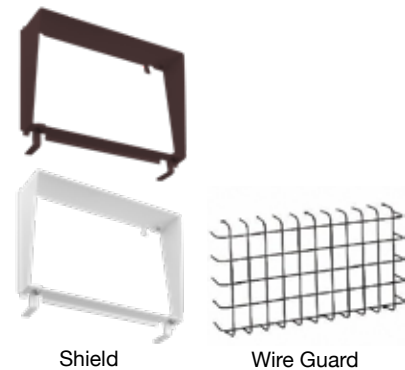

## Mini Area Flood Lights: M-Line

- Knuckle option is 1/2"
- All bracket options fully adjust up and down
- Corrosion-resistant bronze powder coat
- Full weatherproof IP67 Rating Housing

### 3-CCT & Power Select w/ Photocell

Box Qty.  
 2P30- 8  
 2P50- 6  
 3P80- 5

Model	Voltage	Watts	Lumens	Color
LED-ARL-2P30-TRI-BZ-TR-PC	120-277V	30/15w	3,819	50/40/30k
LED-ARL-2P30-TRI-BZ-KN-PC	120-277V	30/15w	3,819	50/40/30k
LED-ARL-2P30-TRI-WH-KN-PC	120-277V	30/15w	3,819	50/40/30k
LED-ARL-2P50-TRI-BZ-TR-PC	120-277V	50/35w	7,000	50/40/30k
LED-ARL-2P50-TRI-BZ-KN-PC	120-277V	50/35w	7,000	50/40/30k
LED-ARL-2P50-TRI-WH-KN-PC	120-277V	50/35w	7,000	50/40/30k
LED-ARL-2P50-TRI-WH-TR-PC	120-277V	50/35w	7,000	50/40/30k
LED-ARL-3P80-TRI-BZ-KN-PC	120-277V	80/70/60w	11,200	50/40/30k
LED-ARL-3P80-TRI-WH-KN-PC	120-277V	80/70/60w	11,200	50/40/30k
LED-ARL-3P80-TRI-BZ-TR-PC	120-277V	80/70/60w	11,200	50/40/30k

### 15W 3-CCT Select

Box Qty.  
 8

Model	Voltage	Watts	Lumens	Color
LED-ARL-15W-TRI-BZ-TR	120-277V	15w	2,100	50/40/30k
LED-ARL-15W-TRI-BZ-KN	120-277V	15w	2,100	50/40/30k
LED-ARL-15W-TRI-WH-KN	120-277V	15w	2,100	50/40/30k

### 30W 3-CCT Select

Box Qty.  
8

Final Production

Model	Voltage	Watts	Lumens	Color
LED-ARL-30W-TRI-BZ-TR	120-277V	30w	3,819	50/40/30k

### 80W 3-CCT Select

Box Qty. Box Qty.  
KN- 5 SFA- 1

Final Production

Model	Voltage	Watts	Lumens	Color
LED-ARL-80W-TRI-WH-KN	120-277V	80w	11,200	50/40/30k
LED-ARL-80W-TRI-BZ-SFA	120-277V	80w	11,200	50/40/30k

\*Custom finishes include white, black, gray, and custom. 7 Day lead time required. Please contact us for pricing based on qty. for custom finish orders.

### Single CCT

Box Qty.  
 8

Final Production

Model	Voltage	Watts	Lumens	Color
LED-ARL-15W-30K-BZ-TR	120-277V	15W	2,100	50/40/30k
LED-ARL-15W-50K-WH-KN	120-277V	15W	2,100	50/40/30k
LED-ARL-30W-30K-BZ-TR	120-277V	30W	3,800	50/40/30k
LED-ARL-30W-30K-BZ-KN	120-277V	30W	3,800	50/40/30k
LED-ARL-30W-30K-WH-KN	120-277V	30W	3,800	50/40/30k
LED-ARL-50W-30K-BZ-TR	120-277V	50W	6,800	50/40/30k

Accessory Model	Accessory Description
ARL-15/30W-SHIELD-BZ	Area Light 15W Shield
ARL-15/30W-SHIELD-WH	Area Light 15W Shield
ARL-15/30W-WG	Area Light 15W Wire Guard
ARL-50W-SHIELD-BZ	Area Light 50W Shield
ARL-50W-SHIELD-WH	Area Light 50W Shield
ARL-50W-WG	Area Light 50W Wire Guard
ARL-80W-SHIELD-BZ	Area Light 80W Shield
ARL-80W-SHIELD-WH	Area Light 80W Shield
ARL-80W-WG	Area Light 80W Wire Guard



### 3CCT+ 3 Power Selectable w/ Photocell-Select XS Body

- Includes 1/2" knuckle (installed on to the fixture)
- Yoke mount included separate in the box
- All bracket options fully adjust up and down



IP67 RATED 80 HIGH CRI DLC LISTED Box Qty. 8

NEW

#### 3-CCT & Power Select w/ Photocell

Model	Voltage	Watts	Lumens	Color
LED-FL-15W-TRI-BZ-KNYK-PC	120-277V	15w	1,950	50/40/30k
LED-FL-15W-TRI-WH-KNYK-PC	120-277V	15w	1,950	50/40/30k
LED-FL-30W-TRI-BZ-KNYK-PC	120-277V	30w	3,900	50/40/30k
LED-FL-30W-TRI-WH-KNYK-PC	120-277V	30w	3,900	50/40/30k

3CCT

### ARCY-Line: Mini Flood Lights

- Includes 1/2" knuckle (installed on to the fixture)
- Trunnion mount included separate in the box
- All bracket options fully adjust up and down



Trunnion

SELECTOR SWITCH IP67 RATED 80 HIGH CRI DLC LISTED Box Qty. 2

NEW

#### 3-CCT & Power Select w/ Photocell

Model	Voltage	Watts	Lumens	Color
LED-ARL3-ARC-3P30-TRI-BZ-UNV-KNT-PC	120-277V	30/25/15w	150lm/w	50/40/30k
LED-ARL3-ARC-3P60-TRI-BZ-UNV-KNT-PC	120-277V	60/50/40w	150lm/w	50/40/30k
LED-ARL3-ARC-3P100-TRI-BZ-UNV-KNT-PC	120-277V	100/80/60w	150lm/w	50/40/30k

3CCT

\*Custom finishes include white, black, gray, and custom. 7 Day lead time required. Please contact us for pricing based on qty. for custom finish orders.

WATT	LUMENS	WATT	LUMENS	WATT	LUMENS
15	2,250	40	6,000	60	9,000
25	3,750	50	7,500	80	12,000
30	4,500	60	9,000	100	15,000

### ARCY-Line: Large Flood Lights

- Bracket options shown on page 9 (brackets sold separately)
- NEMA 7Hx6V optic



SELECTOR SWITCH IP67 RATED 80 HIGH CRI DLC LISTED Box Qty. 2

NEW

#### 3-CCT & Power Select w/ Photocell

Model	Voltage	Watts	Lumens	Color
LED-ARL3-ARC-3P150-TRI-BZ-UNV-PC	120-277V	150/120/80w	150lm/w	50/40/30k
LED-ARL3-ARC-3P150-TRI-BZ-HV-PC	277-480V	150/120/80w	150lm/w	50/40/30k
LED-ARL3-ARC-3P300-TRI-BZ-UNV-PC	120-277V	300/240/180w	150lm/w	50/40/30k
LED-ARL3-ARC-3P300-TRI-BZ-HV-PC	277-480V	300/240/180w	150lm/w	50/40/30k

3CCT

\*Custom finishes include white, black, gray, and custom. 7 Day lead time required. Please contact us for pricing based on qty. for custom finish orders.

WATT	LUMENS	WATT	LUMENS
80	12,000	180	27,000
120	18,000	240	36,000
150	22,500	300	45,000

Back



Top

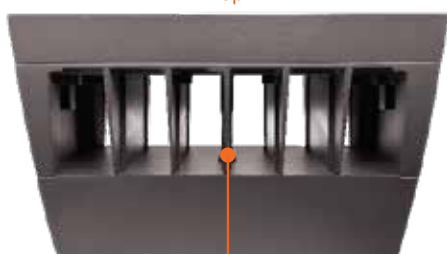

Integrated Heatsink



3-CCT & Wattage Selectable

Photocell

# Large Area Light Optic Line Model

- Bracket options shown on page 9 (brackets sold separately)
  - Easy optic swap: Type III optics installed, Type II, IV, V included
  - 0-10V Dimmable
  - Twist-C technology: Sensor ready socket
- 3-CCT & 5-Power Select**



Box Qty.  
5P150- 4  
5P300- 2



**NEW**

Model	Voltage	Watts	Lumens	Color
LED-ARL3-OPT-5P150-TRI-BZ-UNV	120-277V	150/125/100/75/50w	150lm/w	50/40/30k
LED-ARL3-OPT-5P150-TRI-BZ-HV	277-480V	150/125/100/75/50w	150lm/w	50/40/30k
LED-ARL3-OPT-5P150-TRI-BL-UNV	120-277V	150/125/100/75/50w	150lm/w	50/40/30k
LED-ARL3-OPT-5P150-TRI-BL-HV	277-480V	150/125/100/75/50w	150lm/w	50/40/30k
LED-ARL3-OPT-5P150-TRI-WH-UNV	120-277V	150/125/100/75/50w	150lm/w	50/40/30k
LED-ARL3-OPT-5P150-TRI-WH-HV	277-480V	150/125/100/75/50w	150lm/w	50/40/30k
LED-ARL3-OPT-5P300-TRI-BZ-UNV	120-277V	300/270/240/210/180w	150lm/w	50/40/30k
LED-ARL3-OPT-5P300-TRI-BZ-HV	277-480V	300/270/240/210/180w	150lm/w	50/40/30k
LED-ARL3-OPT-5P300-TRI-BL-UNV	120-277V	300/270/240/210/180w	150lm/w	50/40/30k
LED-ARL3-OPT-5P300-TRI-BL-HV	277-480V	300/270/240/210/180w	150lm/w	50/40/30k
LED-ARL3-OPT-5P300-TRI-WH-UNV	120-277V	300/270/240/210/180w	150lm/w	50/40/30k
LED-ARL3-OPT-5P300-TRI-WH-HV	277-480V	300/270/240/210/180w	150lm/w	50/40/30k
LED-ARL3-OPT-5P450-TRI-BZ-UNV	120-277V	450/420/390/360/330w	150lm/w	50/40/30k
LED-ARL3-OPT-5P450-TRI-BL-UNV	120-277V	450/420/390/360/330w	150lm/w	50/40/30k
LED-ARL3-OPT-5P450-TRI-WH-UNV	120-277V	450/420/390/360/330w	150lm/w	50/40/30k

5P150		5P300	
WATT	LUMENS	WATT	LUMENS
50	7,500	180	27,000
75	11,250	210	31,500
100	15,000	240	36,000
125	18,750	270	40,500
150	22,500	300	45,000

5P450	
WATT	LUMENS
330	49,500
360	54,000
390	58,500
420	63,000
450	67,500

## Shields

Accessory Model	Description
ARL3-OPT-L-HSS-BZ	ARL3: OPTIC-Line: House Side Shield for 5P150
ARL3-OPT-L-HSS-BL	ARL3: OPTIC-Line: House Side Shield for 5P150
ARL3-OPT-L-HSS-WH	ARL3: OPTIC-Line: House Side Shield for 5P150
ARL3-OPT-XL-HSS-BZ	ARL3: OPTIC-Line: House Side Shield for 5P300
ARL3-OPT-XL-HSS-BL	ARL3: OPTIC-Line: House Side Shield for 5P300
ARL3-OPT-XL-HSS-WH	ARL3: OPTIC-Line: House Side Shield for 5P300
ARL3-OPT-XXL-HSS-BZ	ARL3: OPTIC-Line: House Side Shield for 5P450
ARL3-OPT-XXL-HSS-BL	ARL3: OPTIC-Line: House Side Shield for 5P450
ARL3-OPT-XXL-HSS-WH	ARL3: OPTIC-Line: House Side Shield for 5P450

Pre-Installed Accessory Model	Description
Add '-EMB' to model #	Emergency Backup (External 40W/Field Install)
Add '-PC' to model #	Photocell
Add: 20KV to model#	Add: 20KV to model#



Toolless Access to Optic Lens

Toolless Access to Driver

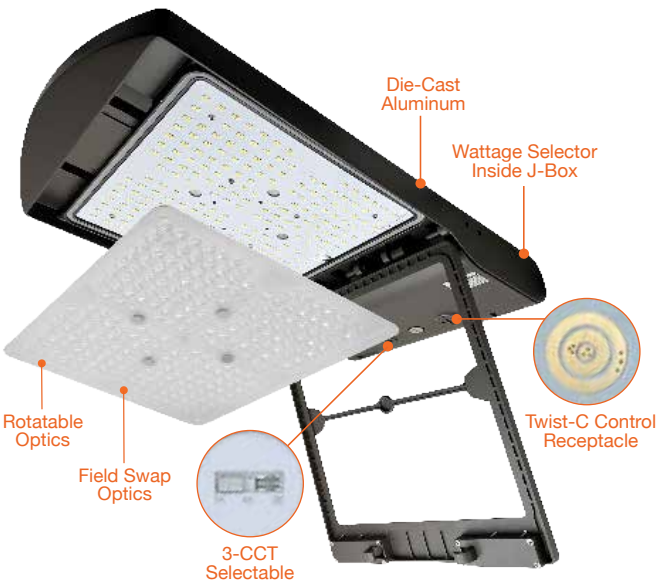

## Rotatable Optic Lens

Field rotation eases lighting design implementation. Rotate lens and receive different light distribution in different directions. No change to fixture installation and EPA

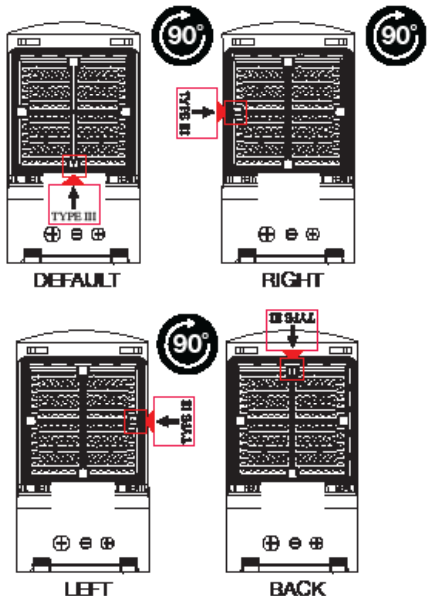



## Large Area Light Gen 3

- Bracket options shown on page 9 (brackets sold separately)
- Type III optics standard, other optics available
- 0-10V Dimmable
- Twist-C technology: Sensor ready socket
- 10Kv Surge Protector Built In

### 3-CCT & 5-Power Select



Model	Voltage	Watts	Lumens	Color
LED-ARL3-5P100-TRI-BZ-UNV	120-277V	100/80/60/40/20w	140 lm/w	50/40/30k
LED-ARL3-5P150-TRI-BZ-UNV	120-277V	150/130/110/90/80w	140 lm/w	50/40/30k
LED-ARL3-5P240-TRI-BZ-UNV	120-277V	150/130/110/90/80w	140 lm/w	50/40/30k
LED-ARL3-5P300-TRI-BZ-UNV	120-277V	300/275/250/225/200w	140 lm/w	50/40/30k
LED-ARL3-5P450-TRI-BZ-UNV	120-277V	450/420/390/360/330w	140 lm/w	50/40/30k



WATT	LUMENS	WATT	LUMENS
20	2,800	200	28,000
40	5,600	215	30,100
60	8,400	225	31,500
70	10,150	240	33,600
90	12,600	250	35,000
100	14,000	275	38,500
110	15,400	300	42,000
130	18,200	330	46,200
140	19,600	360	50,400
150	21,000	390	54,600
165	23,100	420	58,800
190	26,600	450	63,000

## Large Area Light Gen 3 High Voltage

### 3-CCT & 5-Power Select



Model	Voltage	Watts	Lumens	Color
LED-ARL3-5P150-TRI-BZ-HV	277-480V	150/130/110/90/80w	140 lm/w	50/40/30k
LED-ARL3-5P300-TRI-BZ-HV	277-480V	300/275/250/225/200w	140 lm/w	50/40/30k
LED-ARL3-5P450-TRI-BZ-HV	277-480V	450/420/390/360/330w	140 lm/w	50/40/30k



\*Custom finishes include white, black, gray, and custom. 7 Day lead time required. Please contact us for pricing based on qty. for custom finish orders.

Accessory Model	Description
ARL3-100-150W-HSS-BZ	ARL3: House Side Shield for 100W and 150W
ARL3-240-300W-HSS-BZ	ARL3: House Side Shield for 240W and 300W
ARL3-450W-HSS-BZ	ARL3: House Side Shield for 450W



House Side Shield



Accessory Model	Description
ARL3-T-II-100-150	ARL: Type II Optics Lens (25° Beam) Lens
ARL3-T-IV-100-150	ARL2: Type IV Optics Lens (60/90° Beam) Lens
ARL3-T-V-100-150	ARL2: Type V Optics Lens (360° Beam) Lens
ARL3-T-II-240-300	ARL: Type II Optics Lens (25° Beam) Lens
ARL3-T-IV-240-300	ARL2: Type IV Optics Lens (60/90° Beam) Lens
ARL3-T-V-240-300	ARL2: Type V Optics Lens (360° Beam) Lens
ARL3-T-II-450	ARL: Type II Optics Lens (25° Beam) Lens
ARL3-T-IV-450	ARL2: Type IV Optics Lens (60/90° Beam) Lens
ARL3-T-V-450	ARL2: Type V Optics Lens (360° Beam) Lens



Optics Lens



S-TWC-MW-1  
S-TWC-MW-BT  
TWC-DL



S-TWC-PIR-1  
S-TWC-PIR-BT



S-LINE-R

Pre-Installed Accessory Model	Description
Add '-EMB' to model #	Emergency Backup (External 40W/Field Install)
Add '-PC' to model #	Photocell
Add: 20KV to model#	Add: 20KV to model#



Slip Fitter

Straight Arm Adjustable



Yoke

Trunion



Slip Fitter &amp; Straight Arm



House Side Shield

S-TWC-MW-1  
S-TWC-MW-BT  
TWC-DLS-TWC-PIR-1  
S-TWC-PIR-BT

S-LINE-R

## Brackets for ARL3 Fixtures

Accessory Model	Description
ARL3-SF	ARL3: Slip Fitter
ARL3-SF-BL	ARL3: Slip Fitter (Black)
ARL3-SF-WH	ARL3: Slip Fitter (White)
ARL3-SA	ARL3: Straight Arm
ARL3-SA-BL	ARL3: Straight Arm (Black)
ARL3-SA-WH	ARL3: Straight Arm (White)
ARL3-WM	ARL3: Wall Mount Bracket (Requires ARL3-SA for mounting)
ARL3-WM-BL	ARL3: Wall Mount Bracket (Requires ARL3-SA for mounting) (Black)
ARL3-WM-WH	ARL3: Wall Mount Bracket (Requires ARL3-SA for mounting) (White)
ARL3-SFA	ARL3: Slip Fitter/Straight Arm Combo
ARL3-SFA-BL	ARL3: Slip Fitter/Straight Arm Combo (Black)
ARL3-SFA-WH	ARL3: Slip Fitter/Straight Arm Combo (White)
ARL3-ARC-TR	ARL3 Arc: Trunion (Only works with Arc)
ARL3-TR	ARL3: Trunion (Only works with Bolt & Optic-Line)
ARL3-TR-BL	ARL3: Trunion (Only works with Bolt & Optic-Line) (Black)
ARL3-TR-WH	ARL3: Trunion (Only works with Bolt & Optic-Line) (White)
ARL3-YK-100-150	ARL3: Yoke
ARL3-YK-240-450	ARL3: Yoke

## Sensors for ARL3 Fixtures

Accessory Model	Description
S-TWC-MW-1	"Twist-C Microwave Sensor BRIGHTNESS: 100%/ HOLD TIME: 10MIN. BI-LEVEL DIM: 50% STAND BY TIME: 10 MIN SENSITIVITY: 100% DAYLIGHT: ENABLED"
S-TWC-PIR-1	"Twist-C PIR Sensor BRIGHTNESS: 100%/ HOLD TIME: 10MIN. BI-LEVEL DIM: 50% STAND BY TIME: 10 MIN SENSITIVITY: 100% DAYLIGHT: ENABLED"
S-TWC-MW-BT	"Twist-C Microwave Sensor w/ Bluetooth App Control and Group: BRIGHTNESS, HOLD TIME, BI-LEVEL DIM, STAND BY TIME, SENSITIVITY, DAYLIGHT: DISABLED"
S-TWC-PIR-BT	"Twist-C Microwave Sensor BRIGHTNESS: 100%/ HOLD TIME: 10MIN. BI-LEVEL DIM: 50% STAND BY TIME: 1 MIN SENSITIVITY: 100% DAYLIGHT: ENABLED"
TWC-DL	Twist-C Daylight Sensor: Dusk to Dawn, works like a photocell
S-LINE-R	Remote for S-LINE Series Sensors

Pre-Installed Accessory Model	Description
Add '-EMB' to model #	Emergency Backup (Internal 20W)
Add '-PC' to model #	Photocell
Add: 20KV to model#	Add: 20KV to model#

## Large Area Light Gen 2

- Five changable bracket options
- Type III optics standard, other optics available
- 0-10V Dimmable
- Twist-C technology: Sensor ready socket
- 10Kv Surge Protector Built In

### 3-CCT & 3-Power Select

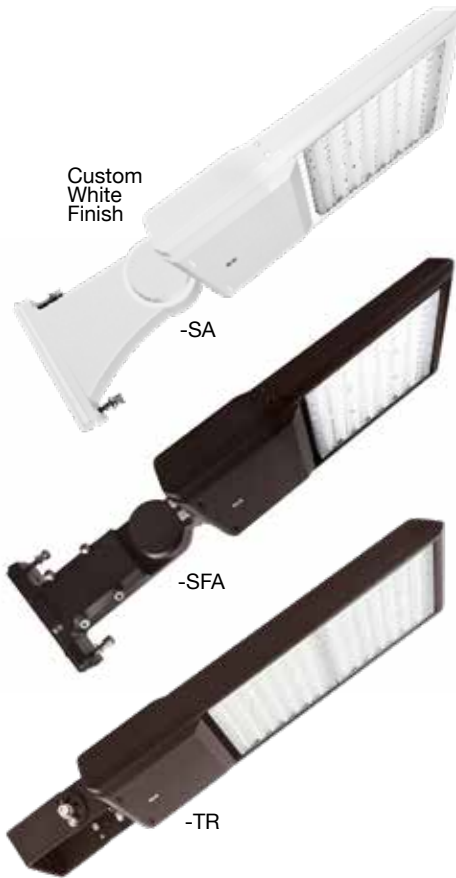

WATT	LUMENS	WATT	LUMENS
60	8,700	180	26,100
80	11,600	210	30,450
100	14,500	240	34,800
120	17,400	260	37,700
135	19,575	280	40,600
150	21,750	300	43,500

Model	Voltage	Watts	Lumens	Color
LED-ARL2-3P100W-TRI-BZ-SF-UNV	120-277V	100/80/60w	140 lm/w	50/40/30k
LED-ARL2-3P100W-TRI-BZ-TR-UNV	120-277V	100/80/60w	140 lm/w	50/40/30k
LED-ARL2-3P100W-TRI-BZ-YK-UNV	120-277V	100/80/60w	140 lm/w	50/40/30k
LED-ARL2-3P150W-TRI-BZ-SF-UNV	120-277V	150/135/120w	140 lm/w	50/40/30k
LED-ARL2-3P240W-TRI-BZ-SF-UNV	120-277V	240/210/180w	140 lm/w	50/40/30k
LED-ARL2-3P240W-TRI-BZ-YK-UNV	120-277V	240/210/180w	140 lm/w	50/40/30k
LED-ARL2-3P300W-TRI-BZ-SF-UNV	120-277V	300/280/260w	140 lm/w	50/40/30k
LED-ARL2-3P300W-TRI-BZ-TR-UNV	120-277V	300/280/260w	140 lm/w	50/40/30k
LED-ARL2-3P300W-TRI-BZ-YK-UNV	120-277V	300/280/260w	140 lm/w	50/40/30k

Model	Voltage	Watts	Lumens	Color
LED-ARL2-3P150W-TRI-BZ-SFA-HV	277-480V	120/135/150w	145 lm/w	50/40/30k

\*Custom finishes include white, black, gray, and custom. 7 Day lead time required. Please contact us for pricing based on qty. for custom finish orders.

Model	Voltage	Watts	Lumens	Color
LED-ARL2-150W-50K-BZ-SF-UNV	120-277V	150w	21,750	5000k
LED-ARL2-150W-50K-BZ-TR-UNV	120-277V	150w	21,750	5000k
LED-ARL2-240W-50K-BZ-SFA-UNV	120-277V	240w	33,790	5000k
LED-ARL2-300W-50K-BZ-SF-UNV	120-277V	300w	40,195	5000k
LED-ARL2-300W-50K-BZ-TR-UNV	120-277V	300w	40,195	5000k
LED-ARL2-300W-50K-BZ-SFA-UNV	120-277V	300w	40,195	5000k

\*Custom finishes include white, black, gray, and custom. 7 Day lead time required. Please contact us for pricing based on qty. for custom finish orders.



Accessory Model	Description
ARL2-OPTICS-T-V	ARL2: Type V Optics Lens (90° Beam) Lens Req'd: (1 x 100w/150w)(2 x 240/300w)
ARL2-TRI-OPTICS-T-II	Type II Optics Lens ARL2 TRI Series (25° Beam) Lens Req'd: (1 x 100w/150w)(2 x 240/300w)
ARL2-TRI-OPTICS-T-IV	Type V Optics Lens ARL2 TRI Series (90°Beam) Lens Req'd: (1 x 100w/150w)(2 x 240/300w)
ARL2-TRI-OPTICS-T-V	Type V Optics Lens ARL2 TRI Series (90°Beam) Lens Req'd: (1 x 100w/150w)(2 x 240/300w)

Accessory Model	Description
ARL2-YK	Yoke Bracket
ARL2-TR	Trunnion Bracket
ARL2-SFA	Slip Fitter and Straight Arm Combo
HB01DMS-A	Bi-Level Motion + Daylight Sensor
ARL2-100/150W-SHIELD-BZ	House Side Shield for 100W and 150W ARL2
ARL2-240/300W-SHIELD-BZ	House Side Shield for 240W and 300W ARL2



WATT	LUMENS
10	1,200
20	2,400
30	3,600

### M-Line: 3" Edge-Lit Cylinder Up/Down Light

- Clear glass lens with optics
- Dark sky compliant
- Corrosion free powder coat
- Beam Angle 60°

#### 3-CCT w/ Photocell



Model	Voltage	Watts	Lumens	Color
LED-CYE-UD-3-3P30-TRI-BZ-PC	120-277V	30/20/10W	120 lm/w	50/40/30k
LED-CYE-UD-3-3P30-TRI-BL-PC	120-277V	30/20/10W	120 lm/w	50/40/30k
LED-CYE-UD-3-3P30-TRI-WH-PC	120-277V	30/20/10W	120 lm/w	50/40/30k



WATT	LUMENS
12	1,250
16	1,600
20	2,000
22	2,200
29	2,750
35	3,100

### ARCY-Line: 4" & 6" Cylinder Up and/or Down Light

- Clear glass lens with optics
- Corrosion free powder coat

#### 3-CCT & 3-Power Select w/ Photocell



Model	Voltage	Watts	Lumens	Color
LED-CYA-UD-4-3P20-TRI-BZ-PC	120-277V	20/16/12W	100 lm/w	50/40/30k
LED-CYA-UD-4-3P20-TRI-BL-PC	120-277V	20/16/12W	100 lm/w	50/40/30k
LED-CYA-UD-4-3P20-TRI-WH-PC	120-277V	20/16/12W	100 lm/w	50/40/30k
LED-CYA-UD-6-3P35-TRI-BZ-PC	120-277V	35/29/22W	90 lm/w	50/40/30k
LED-CYA-UD-6-3P35-TRI-BL-PC	120-277V	35/29/22W	90 lm/w	50/40/30k
LED-CYA-UD-6-3P35-TRI-WH-PC	120-277V	35/29/22W	90 lm/w	50/40/30k

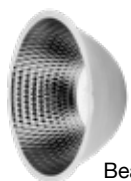

Beam

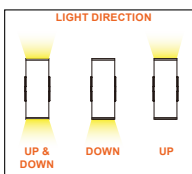

Accessory Model	Description
Add: -15D to Model #	Factory Installed 15D Optic
CYA-UD-4-OPTIC-15	Cylinder: ARCY-Line Optic (Field Install)
CYA-UD-6-OPTIC-15	Cylinder: ARCY-Line Optic (Field Install)



### M-Line: Modern Square Sconce Light

- Clear glass lens
- Corrosion free powder coat

#### 5-CCT Selectable w/ Up & Down Light



Model	Voltage	Watts	Lumens	Color
LED-WSC-UD-15W-5CCT-WH	120-277V	15W	1,000	50/40/35/30/27k
LED-WSC-UD-15W-5CCT-BL	120-277V	15W	1,000	50/40/35/30/27k

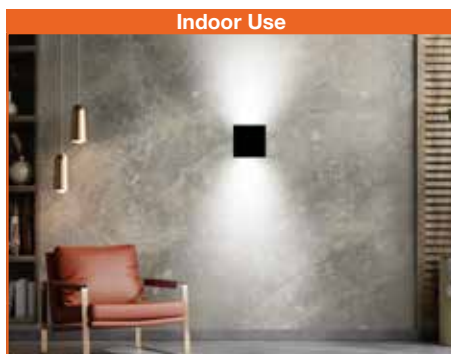

## Tenon Mount For Poles

- Compatible with 2 3/8" slip fitter brackets

**Box Qty: 4**

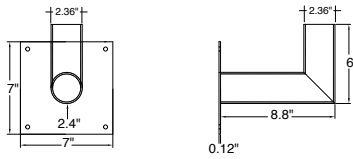

Accessory Model	Description
TN-WM-90-7	Tenon: Wall Mount 90 Degree Arm 7" Mounting Bracket Bronze Finish

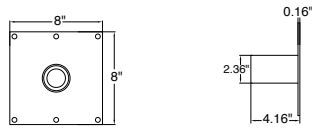

**Box Qty: 4**

Accessory Model	Description
TN-WM-7	Tenon: Wall Mount Straight 4" Mounting Bracket Bronze Finish



**Box Qty: 10**

Accessory Model	Description
TN-RD-3	Tenon: Round 3" Pole Reducer to 2.36"



**Box Qty: 10**

Accessory Model	Description
TN-RD-4	Tenon: Round 4" Pole Reducer to 2.36"

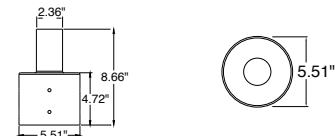

**Box Qty: 6**

Accessory Model	Description
TN-RD-5	Tenon: Round 5" Pole Reducer to 2.36"

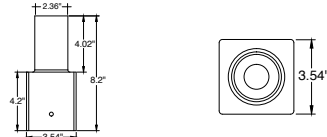

**Box Qty: 10**

Accessory Model	Description
TN-SQ-3	Tenon: Square 3" Pole Reducer to 2.36"

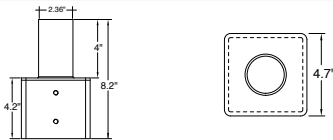

**Box Qty: 10**

Accessory Model	Description
TN-SQ-4	Tenon: Square 4" Pole Reducer to 2.36"

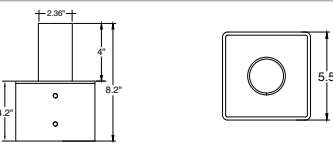

**Box Qty: 10**

Accessory Model	Description
TN-SQ-5	Tenon: Square 5" Pole Reducer to 2.36"

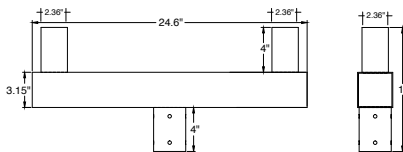

**Box Qty: 1**

Accessory Model	Description
TN-BH-SQ-180-2S	Tenon: Square Bullhorn 2-Head Adapter

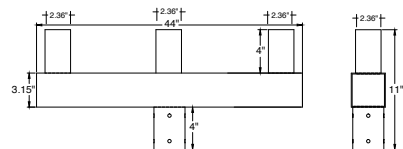

**Box Qty: 1**

Accessory Model	Description
TN-BH-SQ-180-3S	Tenon: Square Bullhorn 3-Head Adapter

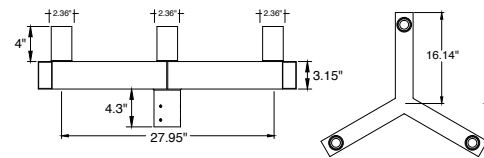

**Box Qty: 1**

Accessory Model	Description
TN-BH-SQ-180-3Y	Tenon: Square Bullhorn 3-Head Y-Adapter

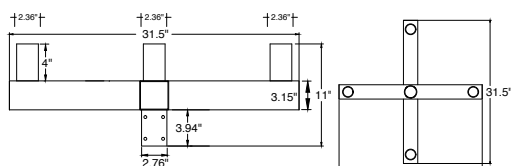

**Box Qty: 1**

Accessory Model	Description
TN-BH-SQ-90-4X	Tenon: Square Bullhorn 4-Head X-Adapter



WATT	LUMENS
35	4,700
50	7,400
75	10,200
100	13,900
125	17,400
150	20,400

### Post Top Fixture

- Foldable design for easy stocking and transportation
- Dark sky compliant
- Fits 2 3/4" pole

### 3-CCT & 3-Power Select



Model	Voltage	Watts	Lumens	Color
LED-PST-3P75-TRI-BZ-UNV	120-277V	75/50/35w	135lm/w	50/40/30k
LED-PST-3P150-TRI-BZ-UNV	120-277V	150/125/100w	135lm/w	50/40/30k



Pre-installed Accessory Model	Description
Add '-EMB' to model #	Emergency Backup (Internal 15W)
Add '-BMS' to model #	Bi-Level Motion + Daylight Sensor
Add '-PC' to model #	Photocell
Add '-HV' to model #	High Voltage (Internal 480V)
Add: 20KV to model#	SG-20KV-UNV: 20KV Surge Protector





## Bullet Flood Knuckle Mount

- 40° Beam Spread
- All bracket options fully adjust up and down
- IP65 Wet Location Rated
- 1/2" Knuckle Mount Included
- Optics on lens allows for consistent beam angle
- Bracket allows for full adjustability

### 3-CCT Select

Model	Voltage	Watts	Lumens	Color
LED-BLT-25W-TRI-BZ-KN-UNV	120-277V	25w	3,500	50/40/30k
LED-BLT-25W-TRI-WH-KN-UNV	120-277V	25w	3,500	50/40/30k

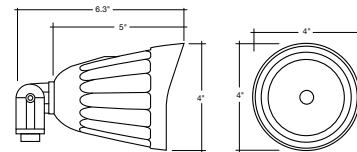

1/2" Knuckle Mount

### 3-CCT & 3-Power Select with Photocell

Model	Voltage	Watts	Lumens	Color
LED-BLT-3P25W-TRI-BZ-KN-UNV	120-277V	25/20/15w	125lm/w	50/40/30k
LED-BLT-3P25W-TRI-WH-KN-UNV	120-277V	25/20/15w	125lm/w	50/40/30k
LED-BLT-3P25W-TRI-BZ-TR-UNV	120-277V	25/20/15w	125lm/w	50/40/30k

WATT	LUMENS
15	1,875
20	2,500
25	3,125

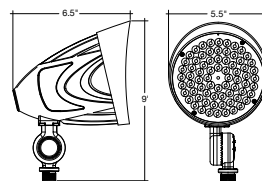

1/2" Knuckle Mount

## Bullet Flood Knuckle Mount

Model	Voltage	Watts	Lumens	Color
LED-BLT-28W-30K-BZ-KN-UNV	120-277V	28w	3,500	3000k
LED-BLT-42W-30K-BZ-KN-UNV	120-277V	42w	5,250	3000k
LED-BLT-42W-50K-BZ-KN-UNV	120-277V	42w	5,250	5000k

Final Production

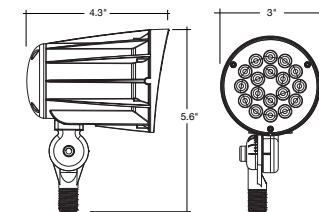

1/2" Knuckle Mount

\*Custom finishes include white, black, gray, and custom. 7 Day lead time required. Please contact us for pricing based on qty. for custom finish orders.



## Area Barn Dusk to Dawn Flood Light

- Dusk to dawn photocell sensor included
- 3 Selectable color temps.: 30/40/50K
- High luminous efficacy: up to 155lm/W

### 3-CCT Select



Model	Voltage	Watts	Lumens	Color
LED-BDD-40W-TRI-SLV-PC	120-277V	40w	6,200	50/40/30k
LED-BDD-40W-TRI-BZ-PC	120-277V	40w	6,200	50/40/30k
LED-BDD-60W-TRI-SLV-PC	120-277V	60w	9,300	50/40/30k
LED-BDD-60W-TRI-BZ-PC	120-277V	60w	9,300	50/40/30k

Accessory Model	Description
BDD-JBX-SLV	Silver J-Box Installation Cover
BDD-JBX-BZ	Bronze J-Box Installation Cover
TN-L-POLE	Pole Installation Tenon Bracket

\*Custom finishes include white, black, gray, and custom. 7 Day lead time required. Please contact us for pricing based on qty. for custom finish orders.



-SLV



-BZ



J-Box Installation Cover  
Available in Silver and Bronze

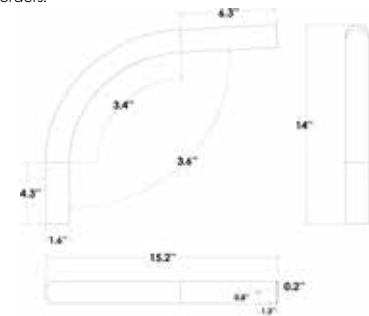

Tenon Bracket Dimensions

## Gooseneck Area Light

- Dusk to dawn photocell sensor included can be turned off with a switch
- 3 Selectable color temps.: 30/40/50K



Model	Voltage	Watts	Lumens	Color
LED-GNB-3P50-TRI-BZ-PC	120-277V	50/40/30w	130 lm/w	50/40/30k
LED-GNB-3P50-TRI-BL-PC	120-277V	50/40/30w	130 lm/w	50/40/30k
LED-GNB-3P50-TRI-WH-PC	120-277V	50/40/30w	130 lm/w	50/40/30k

WATT	LUMENS
30	3,900
40	5,200
50	6,500





## Sports Light Fixture

- All fixtures includes a yoke mount. Slip fitter can be added to the fixture
- Shield is included with the fixture
- Fixture can be adjusted up or down
- Fixture is stocked in black finish
- Free lighting layouts are available
- Product can be customized but with a longer lead time
- Perfect for stadiums and outdoor fields

### Round

- LED driver can be remote mounted away from fixture for easy maintenance



Model	Voltage	Watts	Lumens	Color
LED-SPL-3P600W-50K-YK-UNV-BLK	120-277V	600/450/300w	130 lm/w	5000k
LED-SPL-3P1200W-50K-YK-UNV-BLK	120-277V	1200/1000/800w	130 lm/w	5000k

WATT	LUMENS	WATT	LUMENS
300	39,000	800	124,000
450	58,500	1000	130,000
600	78,000	1200	156,000

### Round RGB

- Compatible with DMX controller (required)

Model	Voltage	Watts	Lumens	Color
LED-SPL-500W-RGB-YK-BLK	120-277V	500w	See Chart	RGB

\*RGB model custom order only

RGB	WATTS	LUMENS
Red/Green/Blue	500	26,600
R	175	3,400
G	175	22,400
B	175	1,866

Accessory Model	Description
SPL-3P600-30D	SPL 3P600: 30D Optic Lens
SPL-3P600-60D	SPL 3P600: 30D Optic Lens
SPL-480V-DRIVER	480V Adder for SPL Fixture (600w requires 1. 1200w requires 2)
SPL-EC-35FT	35FT Extension Cord for remote mount driver



## Square Sports Light



Model	Voltage	Watts	Lumens	Color
LED-SQSPL-3P800W-50K-YK-UNV-BLK	120-277V	800/600/400w	130lm/w	5000k

Accessory Model	Description
SQSPL-AG	SQSPL: Anti-Glare Louver Shield
SQSPL-20D	SQSPL: 20D Optic Lens
SQSPL-55D	SQSPL: 55D Optic Lens

WATT	LUMENS
400	60,000
600	90,000
800	120,000

Accessory Model	Description
SPL-480V-DRIVER	347-480V Adder for Sports Light Fixture (600W: Qty 1 Required 1200W: Qty 1 Required)
SPL-SF	Slip Fitter for Sports Light Fixture
SPL-LSR	Laser Aiming Device

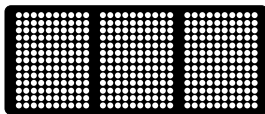

Anti-Glare Shield



SPL-SF



Laser



Slip Fitter

Accessory Model	Description
Add: -PC to Model #	On/off photocell
Add: 20KV to model#	SG-20KV-UNV: 20KV Surge Protector
Add: -HV to model#	480V Adder for SPL Fixture (600w/800w requires 1. 1200w requires 2)



WATT	LUMENS
11	1,560
16	2,080
22	2,860

### Round Bollard Base

- 5 different head options
- Round Version: Base and head sold separately
- Square Version: Head and base sold as a set

#### 3-Power Select / Order Your Base

Box Qty. 1

Model	Height	Finish
BLD-3P22-RD-UNV-BZ-22	22"	Bronze
BLD-3P22-RD-UNV-BL-22	22"	Black
BLD-3P22-RD-UNV-BZ-44	44"	Bronze
BLD-3P22-RD-UNV-BL-44	44"	Black

### Round Bollard Head

#### 5-CCT Select / Order Your Head

Box Qty. 4

Model	Voltage	Watts	Lumens	Color
LED-BLD-RD-5CCT-CN-DM-BZ	120-277V	22/16/12W	130lm/w	50/40/35/30/27K
LED-BLD-RD-5CCT-CN-DM-BL	120-277V	22/16/12W	130lm/w	50/40/35/30/27K
LED-BLD-RD-5CCT-LV-DM-BZ	120-277V	22/16/12W	130lm/w	50/40/35/30/27K
LED-BLD-RD-5CCT-LV-DM-BL	120-277V	22/16/12W	130lm/w	50/40/35/30/27K
LED-BLD-RD-5CCT-CN-FL-BZ	120-277V	22/16/12W	130lm/w	50/40/35/30/27K
LED-BLD-RD-5CCT-CN-FL-BL	120-277V	22/16/12W	130lm/w	50/40/35/30/27K
LED-BLD-RD-5CCT-LV-FL-BZ	120-277V	22/16/12W	130lm/w	50/40/35/30/27K
LED-BLD-RD-5CCT-LV-FL-BL	120-277V	22/16/12W	130lm/w	50/40/35/30/27K

Factory Installed Frosted Lens Available: BLD-RD-FRL

Factory Installed Frosted Lens Available: BLD-RD-SHIELD

#### Square Bollard (Base & Head Included)

Box Qty. 1

WATT	LUMENS
12	1,560
16	2,080
22	2,860

Model	Voltage	Watts	Lumens	Color
LED-BLD-3P22-SQ-5CCT-UNV-CN-FL-BZ-44	120-277V	22/16/12W	130lm/w	50/40/35/30/27K
LED-BLD-3P22-SQ-5CCT-UNV-CN-FL-BL-44	120-277V	22/16/12W	130lm/w	50/40/35/30/27K



WATT	LUMENS
12	1,560
16	2,080
22	2,860

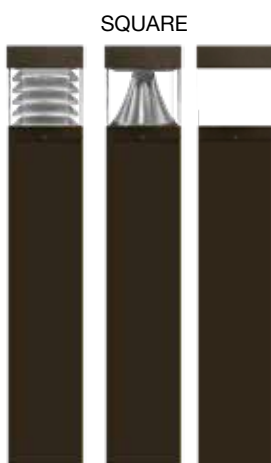

WATT	LUMENS
12	1,560
16	2,080
22	2,860

#### SQUARE FLAT



CONE

#### ROUND DOME



LOUVER



CONE



FROSTED LENS

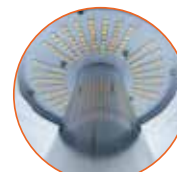

CONE LENS LED

#### ROUND FLAT



LOUVER



CONE



FROSTED LENS



LOUVER LENS LED



BL-BLACK

\*Custom finishes include black, white and custom. 7 Day lead time required. Please contact us for pricing based on qty. for custom finish orders.

Round Bollard Accessories	Description
BLD-RD-FRL	Frosted lens for round heads. Must be factory installed.
BLD-RD-SHIELD	Field installed round 180° shield

Pre-Installed Accessory	Description
Add: -EMB to Model #	90 Minute Emergency Backup
Add: -PC to Model #	On/off photocell
Add: -BMS to Model #	HD407VC-R: Bi Level Motion + Daylight Sensor
Add: 20KV to model#	SG-20KV-UNV: 20KV Surge Protector
Add: -HV to model#	347-480V Step Down Transformer



# Qube Extendable LED Aquarium Light

- Extendable
- 3 light modes
- 5 levels of brightness
- 3 / 6 / 12 hour timer
- 20,000 lifetime hours
- Waterproof sealant
- Acrylic baffle

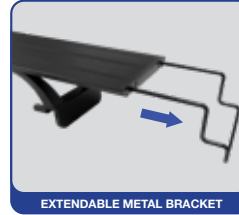
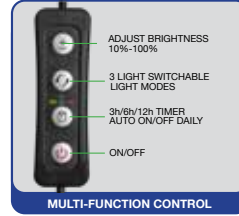

Box Qty. 1



Model	Voltage	Watts	Lumens	Color	CRI
QB-AQUA-12L-9W-FS	100-240V	9w	650	Red, Blue, 6500K	>80
QB-AQUA-16L-14W-FS	100-240V	14w	850	Red, Blue, 6500K	>80
QB-AQUA-22L-16W-FS	100-240V	16w	920	Red, Blue, 6500K	>80
QB-AQUA-28L-20W-FS	100-240V	20w	1,250	Red, Blue, 6500K	>80
QB-AQUA-36L-25W-FS	100-240V	25w	1,600	Red, Blue, 6500K	>80
QB-AQUA-46L-32W-FS	100-240V	32w	1,800	Red, Blue, 6500K	>80

# Qube LED Commercial Growlight

**FULL SPECTRUM**

- Adjust power for any stage of plant life
- Linkable connector to daisy chain multiple lights included
- 10 foot power cord
- 6 foot suspension kit included
- Energy saving LED technology
- Features 8 LED bars compared to industry standard of 6
- Ideal for cannabis growing use
- 0-10V Dimmable to work with grow light control systems

Model	Voltage	Watts	Lumens	Color
QB-FSG-8B-7T660W	120-277V	660w	1716 μMols / 2.6μMol/J	Full Spectrum
QB-FSG-8B-7T960W	120-277V	960w	2496 μMols / 2.6μMol/J	Full Spectrum

- INPUT: AUTO 120-277V**
- IP65 RATED**
- FULL SPECTRUM LED**
- BUILT-IN POWER CONTROL KNOB**
- 0-10V DIMMABLE FOR CONTROL COMPATIBILITY**



## Twist-C Technology Linear Highbay

- 0-10V dimmable integrated driver
- Optional internally-mounted motion sensor
- Twist-C technology: Sensor ready socket

### 3-Power Select

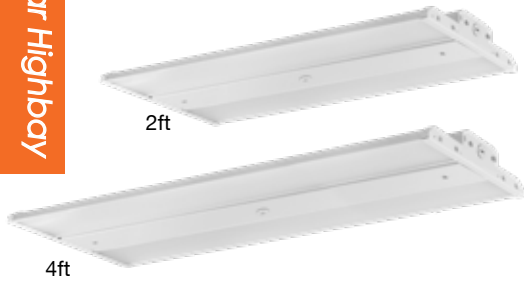

WATT	LUMENS	WATT	LUMENS
60	8,700	200	29,000
80	11,600	220	31,900
110	15,950	240	34,800
125	18,125	260	37,700
150	21,750	280	40,600
160	23,200	290	42,050
165	23,925	320	46,400
180	26,100		

ETA:  
02/2024  
**NEW**

Model	Voltage	Watts	Lumens	Color
LED-LHB-2FT-3P110-F-40K-UNV	120-277V	110/80/60w	145lm/w	4000k
LED-LHB-2FT-3P110-F-50K-UNV	120-277V	110/80/60w	145lm/w	5000k
LED-LHB-2FT-3P165-F-40K-UNV	120-277V	165/150/125w	145lm/w	4000k
LED-LHB-2FT-3P165-F-50K-UNV	120-277V	165/150/125w	145lm/w	5000k
LED-LHB-4FT-3P220-F-40K-UNV	120-277V	220/200/180w	145lm/w	4000k
LED-LHB-4FT-3P220-F-50K-UNV	120-277V	220/200/180w	145lm/w	5000k
LED-LHB-4FT-3P320-F-40K-UNV	120-277V	320/290/260w	145lm/w	4000k
LED-LHB-4FT-3P320-F-50K-UNV	120-277V	320/290/260w	145lm/w	5000k
LED-LHB-4FT-5P320-CTRI-UNV	120-277V	320/280/240/200/160w	145lm/w	5000k

**NEW**

Accessory Model	Description
LHB-3P-4FT-OPTIC-30D	Linear Highbay: Slim-Line G2 30DG Lens for 4ft Model

## Twist-C Technology Linear Highbay

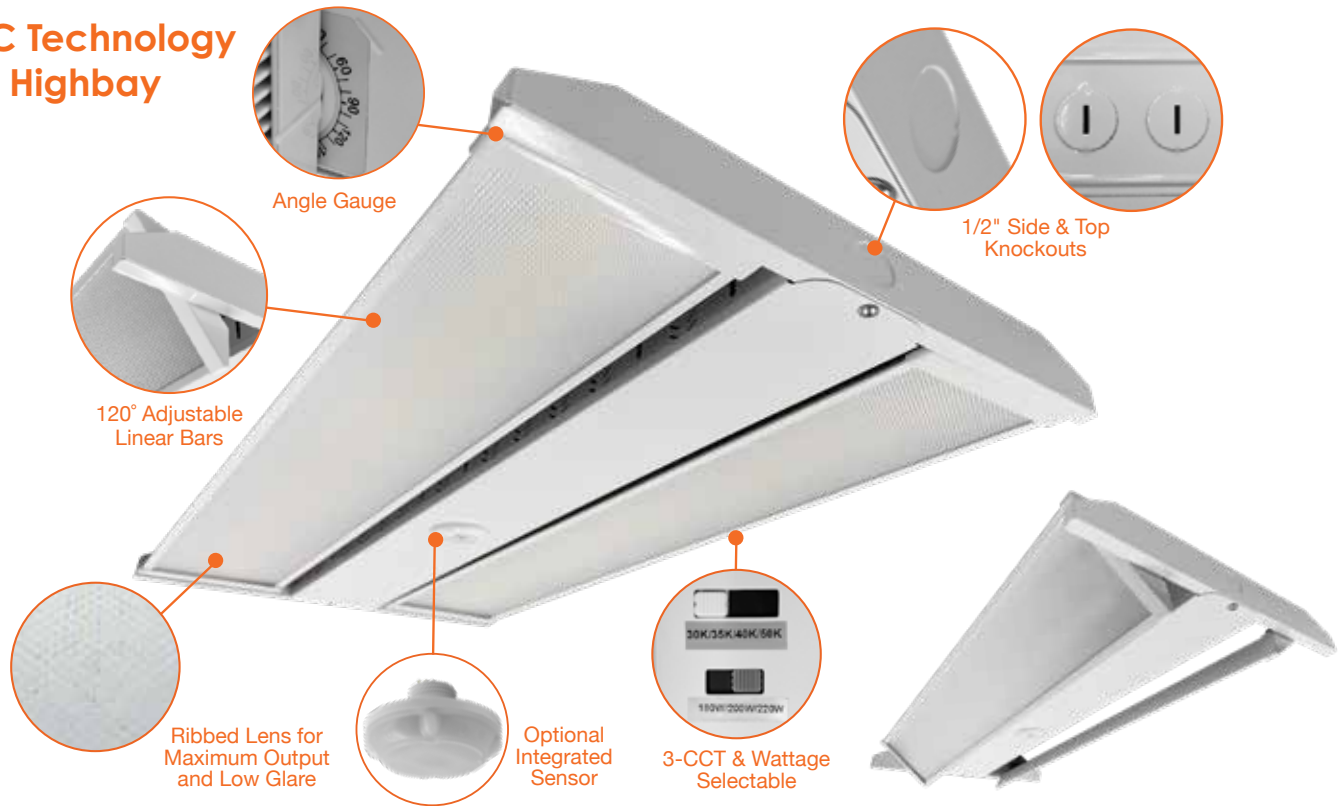

WATT	LUMENS	WATT	LUMENS
60	9,000	260	39,000
110	16,500	290	43,500
165	24,750	320	48,000
180	27,000	380	57,000
200	30,000	410	61,500
220	31,900	440	66,000

### 4-CCT & 3-Power Select



Model	Voltage	Watts	Lumens	Color
LED-LHB-1FT-3P165-4CCT-UNV	120-277V	165/110/60w	150lm/w	50/45/35/30k
LED-LHB-1FT-3P165-4CCT-HV	277-480V	165/110/60w	150lm/w	50/45/35/30k
LED-LHB-2FT-3P220-4CCT-UNV	120-277V	220/200/180w	150lm/w	50/45/35/30k
LED-LHB-2FT-3P220-4CCT-HV	277-480V	220/200/180w	150lm/w	50/45/35/30k
LED-LHB-2FT-3P320-4CCT-UNV	120-277V	320/290/260w	150lm/w	50/45/35/30k
LED-LHB-2FT-3P320-4CCT-HV	277-480V	320/290/260w	150lm/w	50/45/35/30k
LED-LHB-2FT-3P440-4CCT-UNV	120-277V	440/410/380w	150lm/w	50/45/35/30k
LED-LHB-2FT-3P440-4CCT-HV	277-480V	440/410/380w	150lm/w	50/45/35/30k



3P440 lens is not adjustable

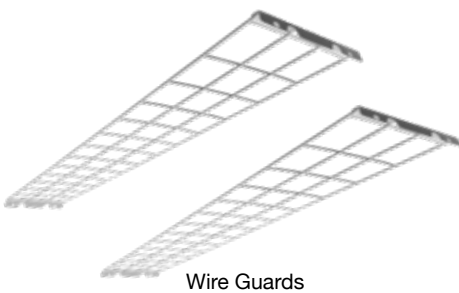

Wire Guards



Emergency Backup



S-TWC-MW-1  
S-TWC-MW-BT  
TWC-DL



S-TWC-PIR-1  
S-TWC-PIR-BT



S-LINE-R



3ft Chain-Link

Accessory Model	Description
6'-WHIP-1/2KO	6' Whip
10'-WHIP-1/2KO	10' Whip
20'-WHIP-1/2KO	20' Whip
LHB-3P165-1FT-WG	LHB: Wire Guard 1ft 3P165
LHB-3P165-2FT-WG	LHB: Wire Guard 2ft 3P165
LHB-3P220-2FT-WG	LHB: Wire Guard 2ft 3P220
LHB-3P320-2FT-WG	LHB: Wire Guard 2ft 3P320
LHB-3P420-2FT-WG	LHB: Wire Guard 2ft 3P420
LHB-3P-4FT-WG	LHB: Wire Guard 4ft 3P220 & 320
LHB-3P-PDM	LHB: Pendant mount bracket up to 320W
LHB-3P440-PDM	LHB: Pendant mount bracket for 440w
LHB-3P-SM	LHB: Surface mount bracket up to 320W
LHB-3P440-SM	LHB: Surface mount bracket for 440w

Pre-installed Accessory Model	Description
Add: -EMB to Model #	90 Minute Emergency Backup
Add: -EMBVH to Model #	90 Minute Emergency Backup for 480V
Add: -20KV to model#	SG-20KV-UNV: 20KV Surge Protector

### Sensors for LED-LHB Fixtures

Accessory Model	Description
S-TWC-MW-1	"Twist-C Microwave Sensor BRIGHTNESS: 100%/ HOLD TIME: 10MIN. BI-LEVEL DIM: 50% STAND BY TIME: 10 MIN SENSITIVITY: 100% DAYLIGHT: ENABLED"
S-TWC-PIR-1	"Twist-C PIR Sensor BRIGHTNESS: 100%/ HOLD TIME: 10MIN. BI-LEVEL DIM: 50% STAND BY TIME: 10 MIN SENSITIVITY: 100% DAYLIGHT: ENABLED"
S-TWC-PIR-BT	"Twist-C PIR Sensor w/ Bluetooth App Control and Group: BRIGHTNESS, HOLD TIME, BI-LEVEL DIM, STAND BY TIME, SENSITIVITY, DAYLIGHT: DISABLED"
S-TWC-MW-BT	"Twist-C Microwave Sensor w/ Bluetooth App Control and Group: BRIGHTNESS, HOLD TIME, BI-LEVEL DIM, STAND BY TIME, SENSITIVITY, DAYLIGHT: DISABLED"
TWC-DL	Twist-C Daylight Sensor: Dusk to Dawn, works like a photocell
S-LINE-R	Remote for S-LINE Series Sensors

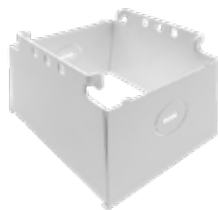

Pendant Mount 2ft

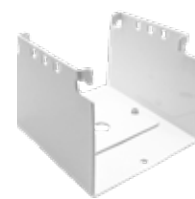

Surface Mount

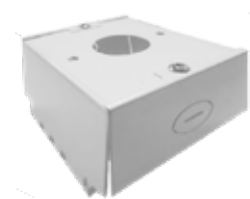

Pendant Mount 4ft



WATT	LUMENS
60	7,800
100	13,000
150	19,500
180	23,400
210	27,300
240	31,200



WATT	LUMENS
60	9,000
100	15,000
150	22,250
180	27,000
210	31,500
240	36,000



Aluminum Reflector (90°)



Surface Mount Yoke



Pendant Emergency Backup



UFO Emergency Test Controller



Acrylic Reflector (90°)



Acrylic Reflector Bottom Cover



Pendant Mount



S-TWC-MW-1  
S-TWC-MW-BT  
TWC-DL



S-TWC-PIR-1  
S-TWC-PIR-BT



S-LINE-R

## Round UFO High Bay

- 0-10V dimmable integrated driver
- IP67 fully waterproof for hosing down
- Durable die-cast aluminum housing
- Twist-C technology: Sensor ready socket

### 3-CCT & 3 Power Select w/ 6' Whip



Model	Voltage	Watts	Lumens	Color
LED-RHB3-3P240-CTRI-WH-6'	120-277V	240/210/180w	130lm/w	50/40/35k



### Single CCT w/ 6' Whip

Model	Voltage	Watts	Lumens	Color
LED-RHB3-100W-40K-BL-6	120-277V	100w	14,000	4000k
LED-RHB3-100W-50K-BL-6	120-277V	100w	14,000	5000k
LED-RHB3-150W-40K-BL-6	120-277V	150w	21,000	4000k
LED-RHB3-240W-40K-BL-6	120-277V	240w	33,600	4000k
LED-RHB3-240W-50K-BL-6	120-277V	240w	33,600	5000k
LED-RHB3-100W-40K-WH-6	120-277V	100w	14,000	4000k
LED-RHB3-100W-50K-WH-6	120-277V	100w	14,000	5000k
LED-RHB3-150W-40K-WH-6	120-277V	150w	21,000	4000k
LED-RHB3-240W-40K-WH-6	120-277V	240w	33,600	4000k

Box Qty. 1



## C-Line: RHB3 UFO High Bay

- 0-10V dimmable integrated driver
- IP67 fully waterproof for hosing down
- Durable die-cast aluminum housing
- Twist-C technology: Sensor ready socket



Model	Voltage	Watts	Lumens	Color
LED-RHB3C-3P150-CTRI-BL-10-UNV	120-277V	150/100/60w	150lm/w	50/40/35k
LED-RHB3C-3P150-CTRI-WH-10-UNV	120-277V	150/100/60w	150lm/w	50/40/35k
LED-RHB3C-3P240-CTRI-BL-10-UNV	120-277V	240/210/180w	150lm/w	50/40/35k
LED-RHB3C-3P240-CTRI-WH-10-UNV	120-277V	240/210/180w	150lm/w	50/40/35k
LED-RHB3C-3P150-CTRI-BL-10-HV	277-480V	150/100/60w	150lm/w	50/40/35k
LED-RHB3C-3P150-CTRI-WH-10-HV	277-480V	150/100/60w	150lm/w	50/40/35k
LED-RHB3C-3P240-CTRI-BL-10-HV	277-480V	240/210/180w	150lm/w	50/40/35k
LED-RHB3C-3P240-CTRI-WH-10-HV	277-480V	240/210/180w	150lm/w	50/40/35k



Pre-installed Accessory Model	Description
3Whip-(3)ft -specify ft in place of #	3 Wire Whip Hot, Neutral, Ground ( \$15 min)
5Whip-(5)ft - specify ft in place of #	5 Wire Whip Hot, Neutral, Ground, Dim (\$21min)
Add: -EMB to Model #	90 Minute Emergency Backup
Add: -EMBVH to Model #	90 Minute Emergency Backup for 480V
Add: -20KV to model#	SG-20KV-UNV: 20KV Surge Protector

Accessory Model	Description
RHB-100/150-SM-BLK	RHB3: 100/150w Surface Mount
RHB-240-SM-BLK	RHB3: 240w Surface Mount
RHB-PDM-HK	RHB3: Pendant Mount Hook 1/2' Pipe
RHB3-100/150-WG	RHB3: 100/150w Wire Guard
RHB3-240-WG	RHB3: 240w Wire Guard
RHB3-100/150-ALM-RF	RHB3: 100/150w Aluminum Reflector 90°
RHB3-240-ALM-RF	RHB3: Aluminum Reflector 90°
RHB3-100/150-ACR-RF	RHB3: 100/150w Acrylic Reflector 90°
RHB3-240-ACR-RF	RHB3: 240w Acrylic Reflector 90°
RHB3-UNV-ACR-BC	RHB3: Acrylic Bottom Cover Universal Fit
LED-EMB-30W-HV-UFO	RHB3: Emergency Back Up (uninstalled)
LED-EMB-30W-HV-UFO-BL	RHB3: Emergency Back Up (Black) (uninstalled)
LED-EMB-30W-HV-UFO-WH	RHB3: Emergency Back Up (White) (uninstalled)
UFO-TEST-CTR	RHB3: Emergency Back Up Test Button Remote Control





-BZ



-WH



HD03R  
Controller

WATT	LUMENS
25	3,625
40	5,800
60	8,700

### Square Slim Canopy Light

- Rugged powder-coated die-cast aluminum housing
- Integrated heatsink
- Silicone seals inhibit moisture ingress

#### 3-CCT & 3-Power Select



Model	Voltage	Watts	Lumens	Color
LED-SCP-3P60W-TRI-WH	120-277V	60/40/25W	145lm/w	50/40/30k
LED-SCP-3P60W-TRI-BZ	120-277V	60/40/25W	145lm/w	50/40/30k

\*Custom finishes include white, black, gray, and custom. 7 Day lead time required. Please contact us for pricing based on qty. for custom finish orders.

Pre-installed Accessory Model	Description
Add '-EMB' to model #	Emergency Backup (Internal 8W)
Add '-BMS' to model #	Bi-Level Motion + Daylight Sensor
Add '-HV' to model #	347-480V Driver for Fixture

Remote for Sensor	Description
HD03R	Remote for HD Sensors
HD05R	Remote for HD Sensors w/ Screen



-BZ



-WH

WATT	LUMENS	WATT	LUMENS
30	4,200	70	10,150
45	6,300	80	11,600
60	8,400	90	13,050

### Arcy-Line: Square Canopy Light

- Rugged powder-coated die-cast aluminum housing
- 10% uplight standard
- Integrated heatsink
- Silicone seals inhibit moisture ingress
- Twist-C technology: Sensor ready socket

#### 3-CCT & 3-Power Select



Model	Voltage	Watts	Lumens	Color
LED-SQUC-3P60-TRI-WH	120-277V	60/45/30W	145lm/w	50/40/30k
LED-SQUC-3P60-TRI-BZ	120-277V	60/45/30W	145lm/w	50/40/30k
LED-SQUC-3P90-TRI-WH	120-277V	90/80/70W	145lm/w	50/40/30k
LED-SQUC-3P90-TRI-BZ	120-277V	90/80/70W	145lm/w	50/40/30k



S-TWC-MW-1  
S-TWC-MW-BT  
TWC-DL



S-TWC-PIR-1  
S-TWC-PIR-BT



S-LINE-R

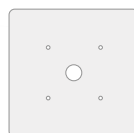

Goof Ring

### Large Square Slim Gas Station Canopy Light

#### Single CCT



Model	Voltage	Watts	Lumens	Color
LED-CP2-WH-150W-50K	120-277V	150w	18,000lm	5000k

\*Custom finishes include white, black, gray, and custom. 7 Day lead time required. Please contact us for pricing based on qty. for custom finish orders.

Accessory Model	Description
24x24-GF-CP2	24x24 Goof Ring

Made to Order  
10-15 Days



-BZ



-WH

## Round Slim Canopy Light

- Wattage selectable and CCT switchable (30/40/50K color temps avail.)
- Rugged powder-coated die-cast aluminum housing
- Silicone seals inhibit moisture ingress
- Twist-C technology: Sensor ready socket

### 3-CCT & 5-Power Select



Model	Voltage	Watts	Lumens	Color
LED-RCP-5P55W-TRI-WH	120-277V	55/47/38.5/30/22W	145lm/w	50/40/30k
LED-RCP-5P55W-TRI-BZ	120-277V	55/47/38.5/30/22W	145lm/w	50/40/30k
LED-RCP-5P100W-TRI-WH	120-277V	100/90/80/70/60w	145lm/w	50/40/30k
LED-RCP-5P100W-TRI-BZ	120-277V	100/90/80/70/60w	145lm/w	50/40/30k

*\*Custom finishes include white, black, gray, and custom. 7 Day lead time required. Please contact us for pricing based on qty. for custom finish orders.*

Pre-installed Accessory Model	Description
Add: -EMB to Model #	90 Minute Emergency Backup
Add: 20KV to model#	SG-20KV-UNV: 20KV Surge Protector
View spec sheet for ordering guide	Paint: Black, White, Gray Standard. Custom RAL Available

WATT	LUMENS	WATT	LUMENS
22	3,190	60	8,700
30	4,350	70	10,150
38.5	5,582	80	11,600
47	6,815	90	13,050
55	7,975	100	14,500

Model	Item Description	Output Volts	Watts
S-TWC-MW-1	Twist-C Microwave Sensor BRIGHTNESS: 100%/ HOLD TIME: 10MIN. BI-LEVEL DIM: 50% STAND BY TIME: 10 MIN SENSITIVITY: 100% DAYLIGHT: ENABLED"	12V	<1W
S-TWC-PIR-1	"Twist-C Microwave Sensor BRIGHTNESS: 100%/ HOLD TIME: 10MIN. BI-LEVEL DIM: 50% STAND BY TIME: 10 MIN SENSITIVITY: 100% DAYLIGHT: ENABLED"	12V	<1W
S-TWC-MW-BT	"Twist-C Microwave Sensor w/ Bluetooth App Control and Group: BRIGHTNESS, HOLD TIME, BI-LEVEL DIM, STAND BY TIME, SENSITIVITY, DAYLIGHT: DISABLED"	12V	<1W
S-TWC-PIR-BT	"Twist-C PIR Sensor w/ Bluetooth App Control and Group: BRIGHTNESS, HOLD TIME, BI-LEVEL DIM, STAND BY TIME SENSITIVITY, DAYLIGHT: DISABLED"	12V	<1W
TWC-DL	Twist-C Daylight Sensor: Dusk to Dawn, works like a photocell	12V	<1W
S-LINE-R	Remote for S-LINE Series Sensors	12V	<1w



S-TWC-MW-1  
S-TWC-MW-BT  
TWC-DL



S-TWC-PIR-1  
S-TWC-PIR-BT



S-LINE-R





### 1x4 Panel - Edge Lit

- LiFud-brand flicker-free integrated driver, 0-10V dimmable
- Edge-lit design provides diffuse, shadowless light
- No UV, no RF, non-yellowing PMMA lens
- Powder-coated white frame



Inner Box Qty. 2  
Master Box Qty. 4  
Must Purchase in  
Box Quantity to  
Avoid Breakage

Model	Voltage	Watts	Lumens	Color
LED-PNL-1x4-40W-40K-LF	120/277V	40w	4,600	4000k
LED-PNL-1x4-40W-35K-LF	120/277V	40w	4,600	3500K

Pre-installed Accessory Model	Description
Add: 3Whip-(3)ft -specify ft in place of #	3 Wire Flex Whip Hot, Neutral, Ground ( \$15 min)
Add: 5Whip-(5)ft - specify ft in place of #	5 Wire Flex Whip Hot, Neutral, Ground, Dim (\$21min)
Add '-EMB' to model #	Emergency Backup (External 15W)



### 2x2 Panel - Edge Lit



Inner Box Qty. 2  
Master Box Qty. 4  
Must Purchase in  
Box Quantity to  
Avoid Breakage

Model	Voltage	Watts	Lumens	Color
LED-PNL-2x2-40W-50K-LF	120-277V	40w	4,600	5000k
LED-PNL-2x2-40W-40K-LF	120-277V	40w	4,600	4000k
LED-PNL-2x2-40W-35K-LF	120-277V	40w	4,600	3500K

Pre-installed Accessory Model	Description
Add: 3Whip-(3)ft -specify ft in place of #	3 Wire Flex Whip Hot, Neutral, Ground ( \$15 min)
Add: 5Whip-(5)ft - specify ft in place of #	5 Wire Flex Whip Hot, Neutral, Ground, Dim (\$21min)
Add '-EMB' to model #	Emergency Backup (External 15W)



### 2x4 Panel - Edge Lit



Inner Box Qty. 2  
Master Box Qty. 4  
Must Purchase in  
Box Quantity to  
Avoid Breakage

Model	Voltage	Watts	Lumens	Color
LED-PNL-2x4-50W-30K-LF	120-277V	50w	5,750	3000k
LED-PNL-2x4-60W-50K-LF	120-277V	60w	6,900	5000k
LED-PNL-2x4-72W-50K-LF	120-277V	72w	8,280	5000k
LED-PNL-2x4-72W-40K-LF	120-277V	72w	8,280	4000k

Pre-installed Accessory Model	Description
Add: 3Whip-(3)ft -specify ft in place of #	3 Wire Flex Whip Hot, Neutral, Ground ( \$15 min)
Add: 5Whip-(5)ft - specify ft in place of #	5 Wire Flex Whip Hot, Neutral, Ground, Dim (\$21min)
Add '-EMB' to model #	Emergency Backup (External 15W)

### 1x4 Panel - Backlit

- Flicker-free integrated driver, 0-10V dimmable
- No UV, no RF, non-yellowing PMMA lens
- Backlit design provides diffuse, shadowless light
- Powder-coated white frame

**Box Qty. 4**  
Must Purchase in  
Box Quantity to  
Avoid Breakage



WATT	LUMENS
20	2,200
30	3,300
40	4,400

*Final Production*  
*Final Production*  
*Final Production*

### 5-CCT & 3-Power Select

Model	Voltage	Watts	Lumens	Color
LED-BPL-1x4-3M40-5CCT	120/277V	40/30/20w	110lm/w	65/50/40/35/30k

### Single CCT

Model	Voltage	Watts	Lumens	Color
LED-BPL-1x4-20W-35K-HL	120/277V	20w	2,600	3500k
LED-BPL-1x4-20W-40K-HL	120/277V	20w	2,600	4000k
LED-BPL-1x4-30W-50K-HL	120/277V	30w	3,900	5000k

### Trim

Accessory	Description
BPL-1X4-TRIM-BL	1x4 LED Panel: Backlit-Line Black Trim

Pre-installed Accessory Model	Description
Add '-EMB' to model #	Emergency Backup (External 15W)
Add '-BMS' to model #	Bi-Level Motion + Daylight Sensor
3Whip-(3)ft - Specify ft in place of #	3 Wire Whip Hot, Neutral, Ground
5Whip-(5)ft - Specify ft in place of #	5 Wire Whip Hot, Neutral, Ground, Dim

### 2x2 Panel - Backlit 5-CCT & 3-Power Select

**Box Qty. 4**  
Must Purchase in  
Box Quantity to  
Avoid Breakage



**3M40**

WATT	LUMENS
20	2,200
30	3,300
40	4,400

**3M50**

WATT	LUMENS
30	3,750
40	5,000
50	6,250

*Final Production*

Model	Voltage	Watts	Lumens	Color
LED-BPL-2x2-3M40-5CCT	120/277V	40/30/20w	110lm/w	65/50/40/35/30k
LED-BPL-2x2-3M50-5CCT-HL	120/277V	50/40/30w	125lm/w	65/50/40/35/30k

### 3-CCT & 3-Power Select

Model	Voltage	Watts	Lumens	Color
LED-BPL-2x2-3M40-TRI	120/277V	40/30/20w	110lm/w	50/40/30k
LED-BPL-2x2-3M40-TRI-BLK	120/277V	40/30/20w	110lm/w	50/40/30k

### Single CCT

Model	Voltage	Watts	Lumens	Color
LED-BPL-2x2-20W-35K-HL	120/277V	20w	2,600	3500k
LED-BPL-2x2-30W-50K-HL	120/277V	30w	3,900	5000k

### Trim

Accessory	Description
BPL-2X2-TRIM-BL	2X2 LED Panel: Backlit-Line Black Trim

Pre-installed Accessory Model	Description
Add '-EMB' to model #	Emergency Backup (External 15W)
Add '-BMS' to model #	Bi-Level Motion + Daylight Sensor
3Whip-(3)ft - Specify ft in place of #	3 Wire Whip Hot, Neutral, Ground
5Whip-(5)ft - Specify ft in place of #	5 Wire Whip Hot, Neutral, Ground, Dim

### 2x4 Panel - Backlit 5-CCT & 3-Power Select

**Box Qty. 4**  
Must Purchase in  
Box Quantity to  
Avoid Breakage



**3M50**

WATT	LUMENS
20	2,200
30	3,300
40	4,400

**3M65**

WATT	LUMENS
45	6,250
55	6,875
65	8,125

Model	Voltage	Watts	Lumens	Color
LED-BPL-2x4-3M50-5CCT	120/277V	40/30/20w	110lm/w	65/50/40/35/30k
LED-BPL-2x4-3M65-5CCT-HL	120/277V	65/55/45w	125lm/w	65/50/40/35/30k

### Trim

Accessory	Description
BPL-2X4-TRIM-BL	2X4 LED Panel: Backlit-Line Black Trim

Pre-installed Accessory Model	Description
Add '-EMB' to model #	Emergency Backup (External 15W)
Add '-BMS' to model #	Bi-Level Motion + Daylight Sensor
3Whip-(3)ft - Specify ft in place of #	3 Wire Whip Hot, Neutral, Ground
5Whip-(5)ft - Specify ft in place of #	5 Wire Whip Hot, Neutral, Ground, Dim



Lumen Selection

Watt Selection

Surface Mount Frame

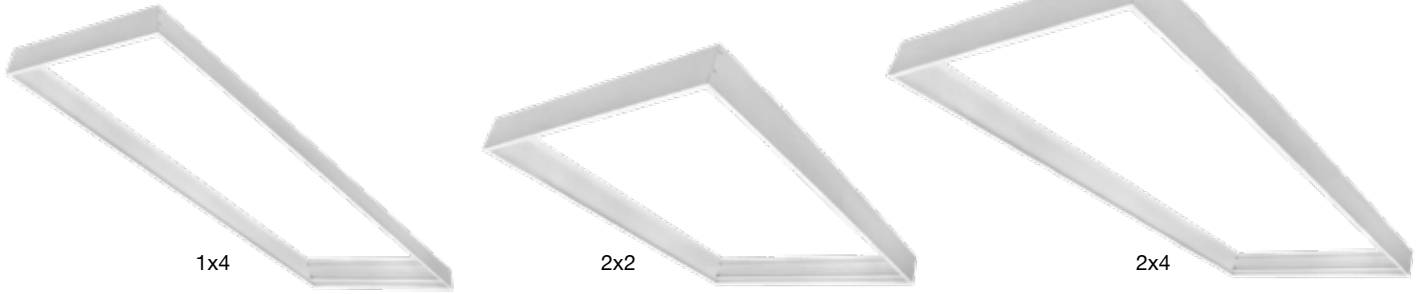

Flange (Drywall) Kit

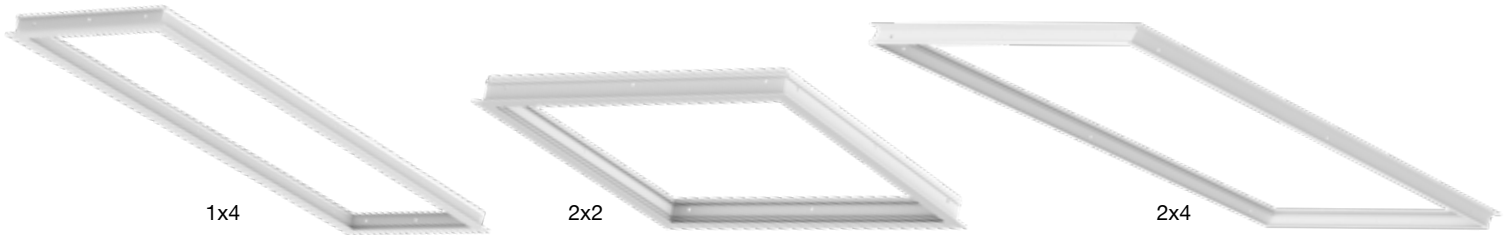

Emergency Backup



Suspension Kit

**1x4 / 2x2 / 2x4 Panel Accessories**

Accessories also work with other 2x2 and 2x4 fixtures (SM only compatible with edge-lit panels)

Model	Description
LED-PNL-2X2-SM	2x2 Surface Mount Kit 2.5" Height (For edge lit series only)
LED-PNL-2X4-SM	2x4 Surface Mount Kit 2.5" Height (For edge lit series only)
LED-PNL-1X4-SM	1X4 Surface Mount Kit 2.5" Height (For edge lit series only)
2X2-SM-3	2x2 Surface Mount Kit 3" Height for all panels and troffers
2X4-SM-3	2x4 Surface Mount Kit 3" Height for all panels and troffers
1X4-SM-3	1x4 Surface Mount Kit 3" Height for all panels and troffers
LED-PNL-2X2-FLNG	2x2 Flange (Drywall) Kit
LED-PNL-2X4-FLNG	2x4 Flange (Drywall) Kit
LED-PNL-1X4-FLNG	1x4 Flange (Drywall) Kit
LED-PNL-2X4-SK	Suspension Kit for Panels

## 1x1 / 1x2 LED Surface Mount Panels

- Internal flicker-free triac-dimmable driver
- Included surface mount bracket mounts directly to j-box
- Edge-lit design provides diffuse, shadowless light
- Only 1" Thick in Size

### 5-CCT Select

SELECT SWITCH DIMMABLE 80 HIGH CRI DLC LISTED Box Qty. 4

Model	Voltage	Watts	Lumens	Color
LED-PNL-SM-1X1-18W-5CCT	120V	18w	1,500	50/40/35/30/27K
LED-PNL-SM-1X2-22W-5CCT	120V	22w	2,000	50/40/35/30/27K

Accessory Model	Description
LED-EMB-25W-HV-0/10V-2P	Emergency Backup (External 25W) Field Install

\*Custom finishes include bronze, black, gray, and custom, 7 Day lead time required. Please contact us for pricing based on qty. for custom finish orders.

## 1x4 / 2x2 / 2x4 LED Surface Mount Panels

- Internal flicker-free 0-10V dimmable driver
- Included surface mount bracket mounts directly to 30 or 40 j-box
- Edge-lit design provides diffuse, shadowless light
- Only 1" thick in size!

### 5-CCT Select

SELECT SWITCH DIMMABLE 80 HIGH CRI DLC LISTED Box Qty. 4

Model	Voltage	Watts	Lumens	Color
LED-BPL-SM-1X4-3M40-5CCT	120/277v	40/30/20w	110lm/w	50/40/35/30/27k
LED-BPL-SM-2X2-3M40-5CCT	120/277v	40/30/20w	110lm/w	50/40/35/30/27k
LED-BPL-SM-2X4-3M50-5CCT	120/277v	50/40/30w	110lm/w	50/40/35/30/27k

### 3-CCT Select

Model	Voltage	Watts	Lumens	Color
LED-PNL-SM-1X4-40W-TRI	120/277v	40w	4,000	50/40/30k
LED-PNL-SM-2X2-40W-TRI	120/277v	40w	4,000	50/40/30k
LED-PNL-SM-2X4-50W-TRI	120/277v	50w	5,000	50/40/30k

Accessory Model	Description
LED-EMB-25W-HV-0/10V-2P	Emergency Backup (External 25W) Field Install

\*Custom finishes include bronze, black, gray, and custom, 7 Day lead time required. Please contact us for pricing based on qty. for custom finish orders.

#### 3M40

WATT	LUMENS
20	2,200
30	3,300
40	4,400

#### 3M50

WATT	LUMENS
30	3,300
40	4,400
50	5,500

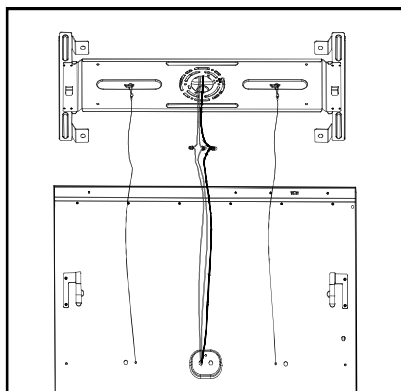

Once wiring has been installed into the fixture, identify and straighten out the 3 wires coming from the fixture to the junction box wires.

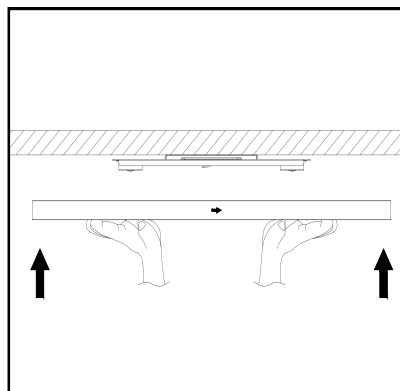

Put the mounting bracket into the panel light first, then aim the shrapnel on the back of the lamp, and put the panel light up.

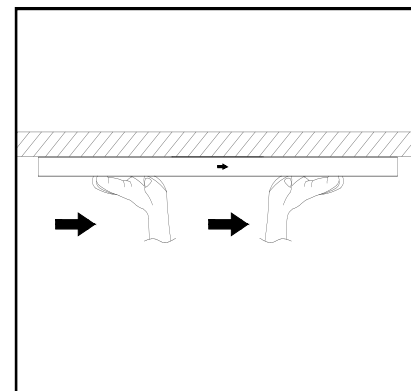

The mounting bracket is pre-mounted to the shrapnel side of the panel light, simply lift and push flush with the ceiling moving accordingly to the direction indicated by the panel light.

## 2x2 & 2x4 LED Center Basket Troffer

- Flicker-free 0-10V dimmable internal driver
- PC body fixture

### 4-CCT & 4-Power Select

Box Qty. 2  
Must Purchase in Box Quantity to Avoid Breakage

Model	Voltage	Watts	Lumens	Color
LED-CBT-2X2-PC-CCT-HL	120-277V	35/30/25/20w	130lm/w	50/40/35/30k
LED-CBT-2X4-PC-CCT-HL	120-277V	50/45/40/35w	130lm/w	50/40/35/30k

2X2		2X4	
WATT	LUMENS	WATT	LUMENS
20	2,600	35	4,550
25	3,250	40	5,200
30	3,900	45	5,850
35	4,550	50	6,500

## 2x2 & 2x4 LED Center Basket Troffer

- Flicker-free 0-10V dimmable internal driver
- Metal body fixture

### 4-CCT & 3-Power Select

Box Qty. 2  
Must Purchase in Box Quantity to Avoid Breakage

Model	Voltage	Watts	Lumens	Color
LED-CBT-2X2-3P35-4CCT	120-277V	35/28/20w	130lm/w	50/40/35/30k
LED-CBT-2X4-3P50-4CCT	120-277V	50/40/30w	130lm/w	50/40/35/30k

2X2		2X4	
WATT	LUMENS	WATT	LUMENS
20	2,600	30	3,900
28	3,900	40	5,200
35	5,200	50	6,500

## 2x2 & 2x4 LED Center Basket Troffer

- Flicker-free 0-10V dimmable internal driver
- Metal body fixture

### 5-CCT & 5-Power Select

Box Qty. 2  
Must Purchase in Box Quantity to Avoid Breakage

Model	Voltage	Watts	Lumens	Color
LED-CBT-2X2-5P40-5CCT	120-277V	40/35/30/25/20w	130lm/w	50/40/35/30/27k
LED-CBT-2X4-5P50-5CCT	120-277V	50/40/30/25/20W	130lm/w	50/40/35/30/27k

## 2x2 & 2x4 LED Center Basket Troffer - Retrofit Kit

### 5-CCT & 5-Power Select

Model	Voltage	Watts	Lumens	Color
LED-CBT-RK-2X2-5P40-5CCT	120-277V	40/35/30/25/20w	130lm/w	50/40/35/30/27k
LED-CBT-RK-2X4-5P50-5CCT	120-277V	50/40/30/25/20W	130lm/w	50/40/35/30/27k

Pre-installed Accessory Model	Description
Add: -EMB to Model #	90 Minute Emergency Backup
Add: -BMS to Model #	S-BMS-INT-1: Bi Level Motion + Daylight Sensor
Add: -BMS-BT to Model #	S-BMS-INT-1-BT: Bi Level Motion + Daylight Sensor W/ Bluetooth Control (ENVISION SMART APP)
Add: -HV to model#	347-480V Step Down Transformer
3Whip-(3)ft - Specify ft in place of #	3 Wire Whip Hot, Neutral, Ground
5Whip-(5)ft - Specify ft in place of #	5 Wire Whip Hot, Neutral, Ground, Dim
Add: -90CRI to model#	CRI90 LED Fixture

5P40		5P50	
WATT	LUMENS	WATT	LUMENS
20	2,500	20	3,750
25	3,125	25	4,375
30	3,750	30	5,000
35	4,375	40	5,625
40	5,000	50	6,250



WATT	LUMENS
12	1,560
15	1,950
18	2,300

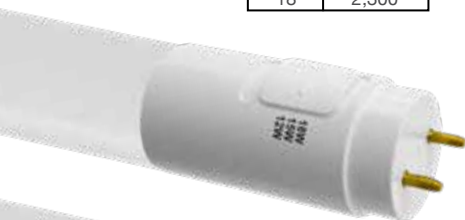

Single Pin Included



R17D Pin Optional



2-Piece Design

## 4' T8 Dimmable Bypass Tubes

- Install tubes without the ballast (single or double sided) any two pins
- Light beam spread replicates the same look as a fluorescent, but with improved light output and efficiency
- PC film protectant for shatter protection (Food Industry OK)

### 5-CCT & 3-Power Select



Box Qty. 30  
Must Purchase in  
Box Quantity to  
Avoid Breakage

Model	Voltage	Watts	Lumens	Color
LED-T8-RFD-GL-4FT-3P18-5CCT	120-277V	12/15/18w	145lm/w	65/50/40/35/30k

NEW



## 2' / 3' / 4' T8 Type A+B Tube

- Install tubes with or without the existing ballast (single or double sided)
- See ballast compatibility chart to ensure compatibility.
- Light beam spread replicates the same look as a fluorescent, but with improved light output and efficiency
- PC film protectant for shatter protection (Food Industry OK)

### 3-CCT Select



Box Qty. 30  
Must Purchase in  
Box Quantity to  
Avoid Breakage

Model	Voltage	Watts	Lumens	Color
LED-T8-DF-GL-2FT-8W-CTRI	120-277V	8w	1,000	50/40/35k
LED-T8-DF-GL-3FT-12W-CTRI	120-277V	12w	1,500	50/40/35k
LED-T8-DF-GL-4FT-15W-CTRI	120-277V	15w	1,950	50/40/35k
LED-T8-DF-GL-4FT-18W-CTRI	120-277V	18w	2,200	50/40/35k



### Single CCT

Model	Voltage	Watts	Lumens	Color
LED-T8-DF-GL-2FT-8W-30K	120-277V	8w	1,000	3000k
LED-T8-DF-GL-2FT-8W-35K	120-277V	8w	1,000	3500k
LED-T8-DF-GL-3FT-12W-30K	120-277V	12w	1,500	3000k
LED-T8-DF-GL-3FT-12W-35K	120-277V	12w	1,500	3500k
LED-T8-DF-GL-4FT-15W-35K	120-277V	15w	1,950	3500k
LED-T8-DF-GL-4FT-15W-40K	120-277V	15w	1,950	4000k
LED-T8-DF-GL-4FT-15W-50K	120-277V	15w	1,950	5000k
LED-T8-DF-GL-4FT-18W-30K	120-277V	18w	2,200	3000k
LED-T8-DF-GL-4FT-18W-35K	120-277V	18w	2,200	3500k
LED-T8-DF-GL-4FT-18W-40K	120-277V	18w	2,200	4000k
LED-T8-DF-GL-4FT-18W-50K	120-277V	18w	2,200	5000k
LED-T8-DF-GL-4FT-18W-65K	120-277V	18w	2,200	6500k

Accessory	Description
T8-8FT-4FT-KIT	T8 Conversion Kit. One 8ft bulb to two 4ft bulbs.

## 8' T8 Type A+B Tube

- Install tubes with or without the existing ballast (double sided connection only)
- See ballast compatibility chart to ensure compatibility.
- 2 Piece LED Design allows for shipping in 4ft box
- Pins are interchangeable: includes double pin and single pin, R17D optional
- Light beam spread replicates the same look as a fluorescent, but with improved light output and efficiency.



Box Qty. 15  
Must Purchase in  
Box Quantity to  
Avoid Breakage

Model	Voltage	Watts	Lumens	Color
LED-T8-DF-GL-8FT-42W-40K	120-277V	42w	5,500	4000k
LED-T8-DF-GL-8FT-42W-50K	120-277V	42w	5,500	5000k

Accessory	Description
R17D-EC	R17(D) End Cap Converter (Switchable end cap for 8' tube)





### 4' T5 Type A+B LED Tube

- Install tubes with or without the existing ballast (single or double sided)
- See ballast compatibility chart to ensure compatibility.
- Light beam spread replicates the same look as a fluorescent, but with improved light output and efficiency
- PC film protectant for shatter protection (Food Industry OK)



Box Qty. 30  
Must Purchase in Box Quantity to Avoid Breakage

Model	Voltage	Watts	Lumens	Color
LED-T5-DF-4FT-24W-40K	120-277V	24w	3,200	4000k
LED-T5-DF-4FT-24W-50K	120-277V	24w	3,200	5000k



### T8 4ft Emergency LED Tube

- Equipped with a self-test function, tests itself monthly/yearly
- Built-in emergency system, easy installation and replacement
- 90 Minute emergency duration
- For use without existitubg ballast, AC Only (See Installation Guide)



Box Qty. 30  
Must Purchase in Box Quantity to Avoid Breakage

NEW

Model	Voltage	Watts	Lumens	Color
LED-T8-EM-4FT-15W-CTRI	120-277V	15w	2,000	35/40/50k
LED-T8-EM-4FT-15W-30K	120-277V	15w	2,000	3500k



### T8 Type A + B U-Shaped LED Bulbs

- Install tubes with or without the existing ballast (single or double sided)
- See ballast compatibility chart to ensure compatibility.
- Light beam spread replicates the same look as a fluorescent, but with improved light output and efficiency
- PC film protectant for shatter protection (Food Industry OK)



Box Qty. 20  
Must Purchase in Box Quantity to Avoid Breakage

#### 3-CCT Select

Model	Voltage	Watts	Lumens	Color
LED-T8U-DF-GL-22X6-15W-CTRI	120-277V	15w	1,950	50/40/35k



### T8 Strip Fixtures (Tubes Not Included)

- LED T8 ready fixtures
- Aligner locks in place for easy continuous row mounting
- Suitable for use in damp locations
- Mount individually or in continuous rows to ceiling or wall

Box Qty. 10

NEW

NEW

NEW

Model	Description
T8-4FT-2LAMP-STRIP	4 FT T8 2-Lamp Strip Fixture (Single Sided Connection)
T8-4FT-2/1L-STRIP	4 FT T8 1 or 2-Lamp Strip Fixture (Double Sided Connection)
T8-8FT-4/2L-STRIP	8 FT T8 2 or 4-Lamp Strip Fixture (Double Sided Connection)
T8-4FT-RF	4FT Symetric White Reflector

### T8 Conversion Kit

Box Qty. 25

Model	Description
T8-8FT-4FT-KIT	T8 Conversion Kit. One 8ft bulb to two 4ft bulbs.

### Dimmable Driver

- Connect the driver to any EnVision tube to dim via 0-10V control

Box Qty. 10

NEW

Model	Description
DIM-MOD-0/10V-TUBE	0-10V Dimmable driver for EnVision LED tubes

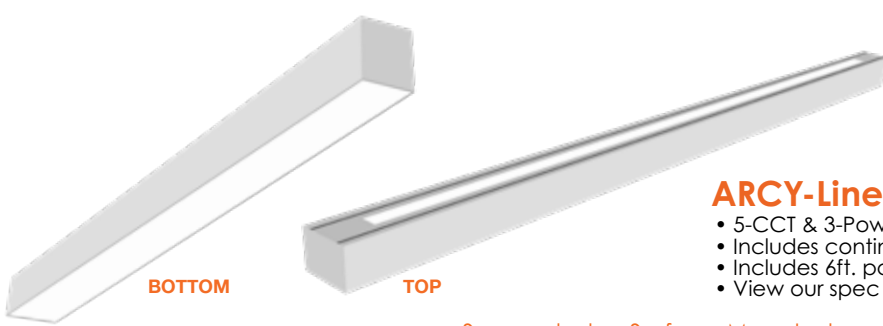

## ARCY-Line: 2" Architectural Linear Fixture

- 5-CCT & 3-Power selectable
- Includes continuous row brackets & jumper cables
- Includes 6ft. power cord & canopy suspension kits
- View our spec sheet for powder coated color options

### Suspended or Surface Mounted Linear Models: Downlight Only



Box Qty.  
3P12- 9 3P25- 9  
3P50- 6 3P75- 4  
3P100- 4

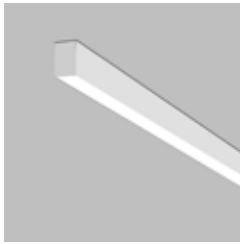

**NEW**

Model	Voltage	Watts	Lumens	Color
LED-ALIN2-1FT-3P12-D-5CCT-WH	120-277V	12/9/6w	1,500/1,080/750	50/40/35/30/27k
LED-ALIN2-2FT-3P25-D-5CCT-WH	120-277V	25/19/13w	3,000/2,280/1,560	50/40/35/30/27k
LED-ALIN2-4FT-3P50-D-5CCT-WH	120-277V	50/38/25w	6,000/4,560/3,000	50/40/35/30/27k
LED-ALIN2-6FT-3P75-D-5CCT-WH	120-277V	75/56/38w	9,000/6,720/4,560	50/40/35/30/27k
LED-ALIN2-8FT-3P100-D-5CCT-WH	120-277V	100/75/50w	12,000/9,000/6,000	50/40/35/30/27k



### Suspended Linear Models: 80% Downlight & 20% Uplight

Made to order, 5-7 days

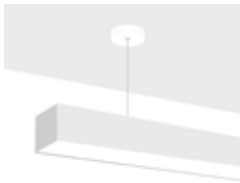

Model	Voltage	Watts	Lumens	Color
LED-ALIN2-2FT-3P25-UD-5CCT-WH	120-277V	25/19/13w	3,000/2,280/1,560	50/40/35/30/27k
LED-ALIN2-4FT-3P50-UD-5CCT-WH	120-277V	50/38/25w	6,000/4,560/3,000	50/40/35/30/27k
LED-ALIN2-6FT-3P75-UD-5CCT-WH	120-277V	75/56/38w	9,000/6,720/4,560	50/40/35/30/27k
LED-ALIN2-8FT-3P100-UD-5CCT-WH	120-277V	100/75/50w	12,000/9,000/6,000	50/40/35/30/27k



### Recessed Linear Models

Made to order, 5-7 days



Model	Voltage	Watts	Lumens	Color
LED-ALIN2-1FT-3P12-D-5CCT-WH-RTK	120-277V	12/9/6w	1,500/1,080/750	50/40/35/30/27k
LED-ALIN2-2FT-3P25-D-5CCT-WH-RTK	120-277V	25/19/13w	3,000/2,280/1,560	50/40/35/30/27k
LED-ALIN2-4FT-3P50-D-5CCT-WH-RTK	120-277V	50/38/25w	6,000/4,560/3,000	50/40/35/30/27k
LED-ALIN2-6FT-3P75-D-5CCT-WH-RTK	120-277V	75/56/38w	9,000/6,720/4,560	50/40/35/30/27k
LED-ALIN2-8FT-3P100-D-5CCT-WH-RTK	120-277V	100/75/50w	12,000/9,000/6,000	50/40/35/30/27k



### Trimless Linear Models

Made to order, 5-7 days



Model	Voltage	Watts	Lumens	Color
LED-ALIN2-1FT-3P12-D-5CCT-WH-TML	120-277V	12/9/6w	1,500/1,080/750	50/40/35/30/27k
LED-ALIN2-2FT-3P25-D-5CCT-WH-TML	120-277V	25/19/13w	3,000/2,280/1,560	50/40/35/30/27k
LED-ALIN2-4FT-3P50-D-5CCT-WH-TML	120-277V	50/38/25w	6,000/4,560/3,000	50/40/35/30/27k
LED-ALIN2-6FT-3P75-D-5CCT-WH-TML	120-277V	75/56/38w	9,000/6,720/4,560	50/40/35/30/27k
LED-ALIN2-8FT-3P100-D-5CCT-WH-TML	120-277V	100/75/50w	12,000/9,000/6,000	50/40/35/30/27k



### Wall Mounted Linear Models: Downlight Only

Made to order, 5-7 days



Model	Voltage	Watts	Lumens	Color
LED-ALIN2-1FT-3P12-D-5CCT-WH-WM	120-277V	12/9/6w	1,500/1,080/750	50/40/35/30/27k
LED-ALIN2-2FT-3P25-D-5CCT-WH-WM	120-277V	25/19/13w	3,000/2,280/1,560	50/40/35/30/27k
LED-ALIN2-4FT-3P50-D-5CCT-WH-WM	120-277V	50/38/25w	6,000/4,560/3,000	50/40/35/30/27k
LED-ALIN2-6FT-3P75-D-5CCT-WH-WM	120-277V	75/56/38w	9,000/6,720/4,560	50/40/35/30/27k
LED-ALIN2-8FT-3P100-D-5CCT-WH-WM	120-277V	100/75/50w	12,000/9,000/6,000	50/40/35/30/27k



### Wall Mounted Linear Models: 80% Downlight & 20% Uplight

Made to order, 5-7 days



Model	Voltage	Watts	Lumens	Color
LED-ALIN2-2FT-3P25-UD-5CCT-WH-WM	120-277V	25/19/13w	3,000/2,280/1,560	50/40/35/30/27k
LED-ALIN2-4FT-3P50-UD-5CCT-WH-WM	120-277V	50/38/25w	6,000/4,560/3,000	50/40/35/30/27k
LED-ALIN2-6FT-3P75-UD-5CCT-WH-WM	120-277V	75/56/38w	9,000/6,720/4,560	50/40/35/30/27k
LED-ALIN2-8FT-3P100-UD-5CCT-WH-WM	120-277V	100/75/50w	12,000/9,000/6,000	50/40/35/30/27k



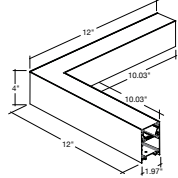

LED-ALIN2-12X12-L-3P25

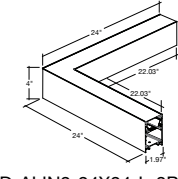

LED-ALIN2-24X24-L-3P50

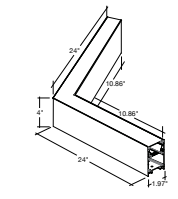

LED-ALIN2-12X12-120L-3P25

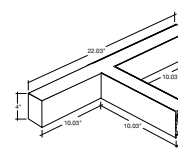

LED-ALIN2-22X10-T-3P36

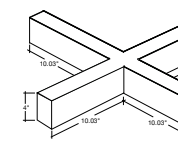

LED-ALIN2-22X22-X-3P50

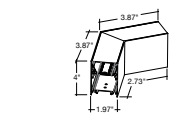

LED-ALIN2-120L-D-5CCT-WH

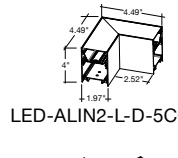

LED-ALIN2-L-D-5CCT-WH

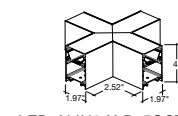

LED-ALIN2-X-D-5CCT-WH

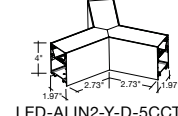

LED-ALIN2-Y-D-5CCT-WH



ALIN2-2/4FT-SRK-WH  
ALIN2-2/4FT-SRK-BL



SK-12FT-CPR-1WR-WH  
SK-12FT-CPR-1WR-BL



Suspended or Surface Mounted Special Shape Models: Downlight Only

Box Qty: 4

Model	Voltage	Watts	Lumens	Color
LED-ALIN2-12X12-L-3P25-D-5CCT-WH	120-277V	25/19/13w	3000/2280/1560	50/40/35/30/27k
LED-ALIN2-12X12-120L-3P25-D-5CCT-WH	120-277V	25/19/13w	3000/2280/1560	50/40/35/30/27k
LED-ALIN2-24X24-L-3P50-D-5CCT-WH	120-277V	50/38/25w	6000/4560/3000	50/40/35/30/27k
LED-ALIN2-22X10-T-3P36-D-5CCT-WH	120-277V	36/25/17w	4320/3000/2040	50/40/35/30/27k
LED-ALIN2-22X22-X-3P50-D-5CCT-WH	120-277V	50/38/25w	6000/4560/3000	50/40/35/30/27k



Suspended Special Shape Models: 80% Downlight & 20% Uplight

Made to order, 5-7 days

Box Qty: 4

Model	Voltage	Watts	Lumens	Color
LED-ALIN2-12X12-L-3P25-UD-5CCT-WH	120-277V	25/19/13w	3000/2280/1560	50/40/35/30/27k
LED-ALIN2-12X12-120L-3P25-UD-5CCT-WH	120-277V	25/19/13w	3000/2280/1560	50/40/35/30/27k
LED-ALIN2-24X24-L-3P25-UD-5CCT-WH	120-277V	50/38/25w	6000/4560/3000	50/40/35/30/27k
LED-ALIN2-22X10-T-3P36-UD-5CCT-WH	120-277V	36/25/17w	4320/3000/2040	50/40/35/30/27k
LED-ALIN2-22X22-X-3P50-UD-5CCT-WH	120-277V	50/38/25w	6000/4560/3000	50/40/35/30/27k



Recessed Special Shape Models

Made to order, 5-7 days

Box Qty: 4

Model	Voltage	Watts	Lumens	Color
LED-ALIN2-12X12-L-3P25-D-5CCT-WH-RTK	120-277V	25/19/13w	3000/2280/1560	50/40/35/30/27k
LED-ALIN2-12X12-120L-3P25-D-5CCT-WH-RTK	120-277V	25/19/13w	3000/2280/1560	50/40/35/30/27k
LED-ALIN2-24X24-L-3P25-D-5CCT-WH-RTK	120-277V	50/38/25w	6000/4560/3000	50/40/35/30/27k
LED-ALIN2-22X10-T-3P36-D-5CCT-WH-RTK	120-277V	36/25/17w	4320/3000/2040	50/40/35/30/27k
LED-ALIN2-22X22-X-3P50-D-5CCT-WH-RTK	120-277V	50/38/25w	6000/4560/3000	50/40/35/30/27k



Trimless Special Shape Models

Made to order, 5-7 days

Box Qty: 4

Model	Voltage	Watts	Lumens	Color
LED-ALIN2-12X12-L-3P25-D-5CCT-WH-TML	120-277V	25/19/13w	3000/2280/1560	50/40/35/30/27k
LED-ALIN2-12X12-120L-3P25-D-5CCT-WH-TML	120-277V	25/19/13w	3000/2280/1560	50/40/35/30/27k
LED-ALIN2-24X24-L-3P25-D-5CCT-WH-TML	120-277V	50/38/25w	6000/4560/3000	50/40/35/30/27k
LED-ALIN2-22X10-T-3P36-D-5CCT-WH-TML	120-277V	36/25/17w	4320/3000/2040	50/40/35/30/27k
LED-ALIN2-22X22-X-3P50-D-5CCT-WH-TML	120-277V	50/38/25w	6000/4560/3000	50/40/35/30/27k



Suspended or Surface Mounted Connector Models: Downlight Only

Box Qty: 10

Model	Voltage	Watts	Lumens	Color
LED-ALIN2-L-D-5CCT-WH	120-277V	7/5/3.5w	840/600/420	50/40/35/30/27k
LED-ALIN2-X-D-5CCT-WH	120-277V	10/7.5/5w	1200/900/600	50/40/35/30/27k
LED-ALIN2-Y-D-5CCT-WH	120-277V	7/5/3.5w	840/600/420	50/40/35/30/27k
LED-ALIN2-120L-D-5CCT-WH	120-277V	7/5/3.5w	840/600/420	50/40/35/30/27k



Recessed Connector Models

Made to order, 5-7 days Box Qty: 10

Model	Voltage	Watts	Lumens	Color
LED-ALIN2-L-D-5CCT-WH-RTK	120-277V	7/5/3.5w	840/600/420	50/40/35/30/27k
LED-ALIN2-X-D-5CCT-WH-RTK	120-277V	10/7.5/5w	1200/900/600	50/40/35/30/27k
LED-ALIN2-Y-D-5CCT-WH-RTK	120-277V	7/5/3.5w	840/600/420	50/40/35/30/27k
LED-ALIN2-120L-D-5CCT-WH-RTK	120-277V	7/5/3.5w	840/600/420	50/40/35/30/27k



Trimless Connector Models

Made to order, 5-7 days Box Qty: 10

Model	Voltage	Watts	Lumens	Color
LED-ALIN2-L-D-5CCT-WH-TML	120-277V	7/5/3.5w	840/600/420	50/40/35/30/27k
LED-ALIN2-X-D-5CCT-WH-TML	120-277V	10/7.5/5w	1200/900/600	50/40/35/30/27k
LED-ALIN2-Y-D-5CCT-WH-TML	120-277V	7/5/3.5w	840/600/420	50/40/35/30/27k
LED-ALIN2-120L-D-5CCT-WH-TML	120-277V	7/5/3.5w	840/600/420	50/40/35/30/27k



Field Install Uplight

Box Qty: 2ft-1 4ft-2

Model	Voltage	Watts	Lumens	Color
ALIN-2FT-UL-5CCT	120-277V	5/4/2.5w	600/480/300	50/40/35/30/27k
ALIN-4FT-UL-5CCT	120-277V	10/7.5/5w	1,200/900/600	50/40/35/30/27k



Suspension Rods

Model	Description
ALIN2-2/4FT-SRK-WH	Suspension Rod Kit 2/4' length
ALIN2-2/4FT-SRK-BL	Suspension Rod Kit 2/4' length

Suspension Kit

Model	Description
SK-12FT-CPR-1WR-WH	Suspension Kit: 12' Canopy Top 1 Wire (2 pcs)
SK-12FT-CPR-1WR-BL	Suspension Kit: 12' Canopy Top 1 Wire (2 pcs)

Pre-installed	Description
Add '-EMB' to model #	Emergency Backup (External 15W)
Add '-BMS' to model #	Bi-Level Motion + Daylight Sensor

## 2' / 4' / 8' Arcy-Line: LED Suspended Tubular Linear

- Seamless linkable connection
  - 0-10V Dimming for controls
  - Fixture can be surface mounted, wall mounted, or suspended
- Suspended or Surface Mounted Linear  
Models: Downlight Only



Box Qty for 2FT: 12  
Box Qty for 4FT: 6 Box Qty for 8FT: 6



WATT	LUMENS
2.5	300
4	480
5	600
7.5	900
10	1,200



Model	Voltage	Watts	Lumens	Color
LED-TBL-2FT-20W-D-4CCT-WH	120-277V	20w	2,300	50/40/35/30k
LED-TBL-4FT-40W-D-4CCT-WH	120-277V	40w	4,600	50/40/35/30k
LED-TBL-8FT-80W-D-4CCT-WH	120-277V	80w	9,200	50/40/35/30k

### Suspended Linear Models: 80% Downlight & 20% Uplight

Model	Voltage	Watts	Lumens	Color
LED-TBL-2FT-20W-UD-4CCT-WH	120-277V	20w	2,300	50/40/35/30k
LED-TBL-4FT-40W-UD-4CCT-WH	120-277V	40w	4,600	50/40/35/30k
LED-TBL-8FT-80W-UD-4CCT-WH	120-277V	80w	9,200	50/40/35/30k

### Accessories

Model	Description
SK-6FT-I-CP-TH	6" Suspension Kit for ATL
TBL-L	L-Shape Connector

### Pre-installed Accessory Model Description

Add: -EMB to Model #	90 Minute Emergency Backup
Add: -BMS to Model #	Bi Level Motion + Daylight Sensor
Add: 20KV to model#	SG-20KV-UNV: 20KV Surge Protector

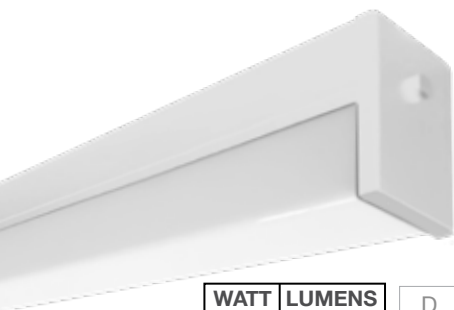

WATT	LUMENS
30	3,900
40	5,200
50	6,500



## 4' Drop Lens Suspended Linear: C-Line

- Includes 6' power cord and canopy suspension kit
- 50,000-hour LED lifespan based on IES LM-90 results

### Suspended Linear Models: Downlight Only



Box Qty. 6

Model	Voltage	Watts	Lumens	Color
LED-ELIN-4FT-3P50-5CCT-WH	120-277V	50/40/30w	130lm/w	50/40/35/30/27k
LED-ELIN-4FT-3P50-5CCT-BL	120-277V	50/40/30w	130lm/w	50/40/35/30/27k

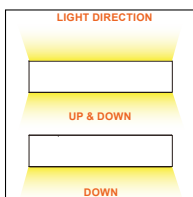
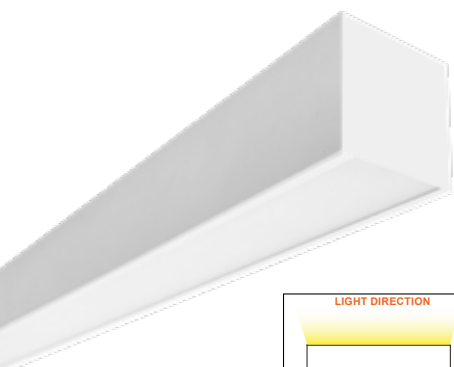

ETA: 3/2024

## 2' / 4' / 8' Suspended Linear Up & Downlight: C-Line

- Includes 6' power cord and canopy suspension kit
- 50,000-hour LED lifespan based on IES LM-90 results
- Up and downlight selectable

### Suspended Linear Models: Down or Uplight



Box Qty. 6

Model	Voltage	Watts	Lumens	Color
LED-UDL2-2FT-3P25-5CCT-WH	120-277V	25/20/15w	125lm/w	50/40/35/30/27k
LED-UDL2-2FT-3P25-5CCT-BL	120-277V	25/20/15w	125lm/w	50/40/35/30/27k
LED-UDL2-4FT-3P50-5CCT-WH	120-277V	50/40/30w	125lm/w	50/40/35/30/27k
LED-UDL2-4FT-3P50-5CCT-BL	120-277V	50/40/30w	125lm/w	50/40/35/30/27k
LED-UDL2-8FT-3P100-5CCT-WH	120-277V	100/80/60w	125lm/w	50/40/35/30/27k
LED-UDL2-8FT-3P100-5CCT-BL	120-277V	100/80/60w	125lm/w	50/40/35/30/27k

### Accessory Description

NEW UDL-4XJ	4-Way Joiner
-------------	--------------

WATT	LUMENS	WATT	LUMENS	WATT	LUMENS
15	1,875	30	3,750	60	7,500
20	2,500	40	5,000	80	10,000
25	3,125	50	6,250	100	12,500



### 23" Suspended Cylinder

- 50% up & down light LGP diffuser
- Includes 6' power cord and canopy suspension kit
- 50,000-hour LED lifespan based on IES LM-90 results

#### 3-CCT Select

Box Qty. 2

Model	Voltage	Watts	Lumens	Color
LED-SRD-23-50W-UD-RTRI-WH	120-277V	50w	5,000	35/40/50k
LED-SRD-23-50W-UD-RTRI-BL	120-277V	50w	5,000	35/40/50k

Pre-installed Accessory Model	Description
Add: -EMB to Model #	90 Minute Emergency Backup



### Round Strip LED Fixture

- 4' & 8' models are wattage selectable
- Includes 4O J-Box cover
- 50,000-hour LED lifespan based on IES LM-90 results
- Fixture can be surface mounted, wall mounted, or suspended
- BMS: Bi-Level Motion + Daylight Sensor
- EMB: Emergency Back Up: 90 minutes

#### 2' Models

Box Qty. 12

Model	Voltage	Watts	Lumens	Color
LED-RST-2FT-20W-4CCT	120-277V	20w	2,600	50/40/35/30k
LED-RST-2FT-20W-4CCT-BL	120-277V	20w	2,600	50/40/35/30k

#### 4' Models

Box Qty. 6

Model	Voltage	Watts	Lumens	Color
LED-RST-4FT-3M40W-4CCT	120-277V	40/30/20w	145lm/w	50/40/35/30k
LED-RST-4FT-3M40W-4CCT-BL	120-277V	40/30/20w	145lm/w	50/40/35/30k
LED-RST-4FT-3M80W-4CCT	120-277V	80/65/50w	145lm/w	50/40/35/30k

#### 8' Models

Box Qty. 6

Model	Voltage	Watts	Lumens	Color
LED-RST-8FT-3M60W-4CCT	120-277V	60/50/40w	145lm/w	50/40/35/30k
LED-RST-8FT-3M60W-4CCT-BL	120-277V	60/50/40w	145lm/w	50/40/35/30k
LED-RST-8FT-3M100W-4CCT	120-277V	100/85/70w	145lm/w	50/40/35/30k
LED-RST-8FT-3M100W-4CCT-BL	120-277V	100/85/70w	145lm/w	50/40/35/30k

WATT	LUMENS	WATT	LUMENS
20	2,600	50	6,500
30	3,900	65	8,450
40	5,200	80	10,400

WATT	LUMENS	WATT	LUMENS
40	5,200	70	9,100
50	6,500	85	11,050
60	7,800	100	13,000

Pre-installed Accessory Model	Description
Add: -EMB to Model #	90 Minute Emergency Backup
Add: -BMS to Model #	Microwave Bi Level Motion + Daylight Sensor
Add: -BMSPIR to Model #	PIR Bi Level Motion + Daylight Sensor
Add: -HV to Model#	347-480V Step Down Transformer

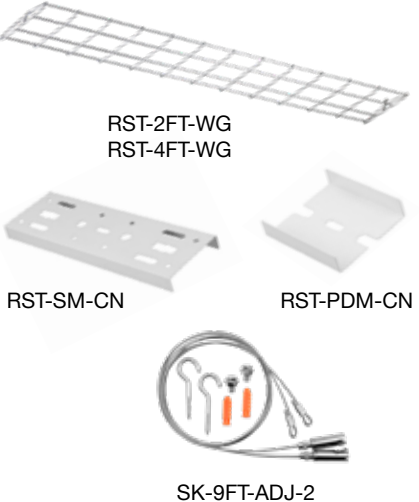

### Accessories for RST Fixtures

Model	Description
RST-SM-CN	Surface Mount Linkable Bracket
RST-PDM-CN	Pendant Mount Linkable Bracket
RST-2FT-WG	2ft Long Wire Guard for 2ft RST
RST-4FT-WG	4ft Long Wire Guard, use 2 pieces for 8ft
SK-9FT-ADJ-2	9ft Suspension Kit Adjustable

## 2' & 4' Prismatic LED Lens Wraps

- Lens is held by a spring making it easily removable for surface mount installation
- Single CCT is non-dimmable
- 6-CCT is 0-10V dimmable
- Fixture can be surface mounted, wall mounted, or suspended

ETA:  
2/2024



Box Qty for 2ft: 12  
Box Qty for 4ft: 6

**NEW**

Model	Voltage	Watts	Lumens	Color
LED-WRP-PRM-2FT-20W-6CCT-UNV	120-277V	20w	2,300	65/50/40/35/30/27k
LED-WRP-PRM-4FT-40W-6CCT-UNV	120-277V	40w	4,600	65/50/40/35/30/27k

6CCT



Features a spring design allowing easy removal of lens for installation

Model	Voltage	Watts	Lumens	Color
LED-WRP-PRM-2FT-20W-40K	120-277V	20w	1,900	4000k
LED-WRP-PRM-2FT-20W-50K	120-277V	20w	1,900	5000k
LED-WRP-PRM-4FT-40W-35K	120-277V	40w	3,800	3500k
LED-WRP-PRM-4FT-40W-40K	120-277V	40w	3,800	4000k
LED-WRP-PRM-4FT-40W-50K	120-277V	40w	3,800	5000k

Pre-installed Accessory Model	Description
Add '-MS' to model #	On/Off Motion Sensor
Add '-EMB' to model #	Emergency Backup (External 15W)

## 2' & 4' Frosted LED Lens Wraps

- Lens is removable for easy surface mount installation
- Sturdy aluminum housing prevents bending
- 0-10V Dimming for controls
- Fixture can be surface & wall mounted or suspended

ETA:  
2/2024



Box Qty for 2ft: 12  
Box Qty for 4ft: 6

**NEW**

Model	Voltage	Watts	Lumens	Color
LED-WRP-FR-2FT-3P24-6CCT-UNV	120-277V	24/20/16w	115lm/w	65/50/40/35/30/27k
LED-WRP-FR-4FT-3P48-6CCT-UNV	120-277V	48/40/32w	115lm/w	65/50/40/35/30/27k

6CCT



WATT	LUMENS
16	1,840
20	2,300
24	2,760
32	3,680
40	4,600
48	5,520

Model	Voltage	Watts	Lumens	Color
LED-WRP-FR-2FT-20W-40K	120-277V	20w	2,200	4000k
LED-WRP-FR-2FT-20W-50K	120-277V	20w	2,200	5000k
LED-WRP-FR-4FT-48W-35K	120-277V	48w	5,040	3500k
LED-WRP-FR-4FT-48W-40K	120-277V	48w	5,040	4000k
LED-WRP-FR-4FT-48W-50K	120-277V	48w	5,040	5000k

Pre-installed Accessory Model	Description
Add '-BMS' to model #	On/Off Motion Sensor
Add '-EMB' to model #	Emergency Backup (External 15W)
Add '-BMS-EMB' to model #	Motion Sensor + Emergency Backup

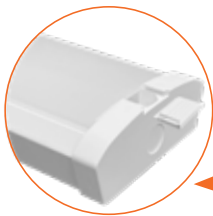

1/2" Knockout

## Accessories for Wraps

Model	Description
SK-9FT-ADJ-2	9ft Suspension Kit Adjustable



## 2' / 4' / 8' Vapor Tight LED Fixture

- Environmental friendly polyester powder coated
- Anti-rust durable plastic housing
- 50,000-hour LED lifespan based on IES LM-90 results

Box Qty:  
 3M25 - 12  
 3M50 - 6  
 3M80 - 6  
 3M100 - 4

### 4-CCT & 3 Power Select



Model	Voltage	Watts	Lumens	Color
LED-VPT-2FT-3M25-4CCT	120-277V	25/20/15w	130lm/w	50/40/35/30k
LED-VPT-4FT-3M50-4CCT	120-277V	50/40/30w	130lm/w	50/40/35/30k
LED-VPT-4FT-3M80-4CCT	120-277V	80/70/60w	130lm/w	50/40/35/30k
LED-VPT-8FT-3M100-4CCT	120-277V	100/90/80w	130lm/w	50/40/35/30k

WATT	LUMENS	WATT	LUMENS
15	1,950	60	7,800
20	2,600	70	9,100
25	3,250	80	10,400
30	3,900	90	11,700
40	5,200	100	13,000
50	6,500		



## 4' Green Vapor Tight LED Fixture

- Ideal for use in horticultural neutral light applications

NEW

Model	Voltage	Watts	Lumens	Color
LED-VPT-4FT-80W-GREEN	120-277V	80w	4200	Green

Pre-installed Accessory Model	Description
Add: -EMB to Model #	90 Minute Emergency Backup
Add: -BMS to Model #	HD407VC-R Bi Level Motion + Daylight Sensor
Add: 20KV to Model #	SG-20KV-UNV: 20KV Surge Protector
Add: -HV to Model #	347-480V Step Down Transformer

Model	Description
SK-9FT-ADJ-2	9ft Suspension Kit Adjustable



Vertical



Horizontal

## Jelly Jar Vapor Tight / Vertical and Horizontal

- All in one: Works for vertical or horizontal installation
- 0-10V dimming standard

### 3-CCT Select



Model	Voltage	Watts	Lumens	Color	CRI
LED-JJ-21W-TRI	120-277V	21w	2700	50/40/30k	>80



### 1" Mini Low Voltage Downlights

- Smaller lamp body for flexible application
- Low-Voltage Daisy-Chain Wiring
- 5-100% dimming compatible with Electronic Low Voltage drivers (see CV series)



Model	Voltage	Watts	Lumens	Color
LED-MDL-1-6W-30K-RD-WH-12V	12V	6w	500	3000k

Accessory Model	Description
MDL-TRIM-RD-BLK	1" Mini Downlight Round Black Trim
MDL-TRIM-RD-BZ	1" Mini Downlight Round Bronze Trim
MDL-TRIM-SQ-WH	1" Mini Downlight Square White Trim
MDL-TRIM-SQ-BLK	1" Mini Downlight Square Black Trim
MDL-TRIM-SQ-BZ	1" Mini Downlight Square Bronze Trim
MDL-24°-OPTIC	1" Mini Downlight Optic Lens 24°



-BZ



-BLK



-BZ



-BLK

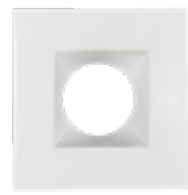

-WH



-WH



-BLK



-BZ

### 1" Mini Low Voltage Downlight Adjustable

- Adjustable fixture allows 60° pitch angle
- Low-Voltage Daisy-Chain Wiring
- 5-100% dimming compatible with Electronic Low Voltage drivers (see CV series)



Model	Voltage	Watts	Lumens	Color
LED-MDL-1-ADJ-6W-30K-RD-WH-12V	12V	6w	500	3000k
LED-MDL-1-ADJ-6W-30K-RD-BLK-12V	12V	6w	500	3000k
LED-MDL-1-ADJ-6W-30K-RD-BZ-12V	12V	6w	500	3000k
LED-MDL-1-ADJ-6W-30K-SQ-WH-12V	12V	6w	500	3000k
LED-MDL-1-ADJ-6W-30K-SQ-BLK-12V	12V	6w	500	3000k
LED-MDL-1-ADJ-6W-30K-SQ-BZ-12V	12V	6w	500	3000k



-WH



-BLK



-BZ





## 2" LED Trimless Round Downlight

- External J-Box Eliminates Recessed Can
- New Construction Mounting Plate Available
- Suitable for Use in Wet Locations
- IC & Airtight-Rated Fixture
- EMB: Emergency Back Up: 90 minutes

5-CCT Select

Box Qty: 18

Model	Voltage	Watts	Lumens	Color
LED-DLJBX-TML-2R-8W-5CCT-WH	120V	8w	600	50/40/35/30/27K
LED-DLJBX-TML-2R-8W-5CCT-BLK	120V	8w	600	50/40/35/30/27K
LED-DLJBX-TML-2R-15W-5CCT-WH	120V	15w	1000	50/40/35/30/27K
LED-DLJBX-TML-2R-15W-5CCT-BLK	120V	15w	1000	50/40/35/30/27K



## 2" LED Trimless Gimbal Downlight

5-CCT Select

Box Qty: 18

Model	Voltage	Watts	Lumens	Color
LED-DLJBX-TML-GMB-2R-8W-5CCT-WH	120V	8w	600	50/40/35/30/27K
LED-DLJBX-TML-GMB-2R-8W-5CCT-BLK	120V	8w	600	50/40/35/30/27K



## 4" LED Trimless Round Downlight

5-CCT Select

Box Qty: 18

Model	Voltage	Watts	Lumens	Color
LED-DLJBX-TML-4R-15W-5CCT-WH	120V	15w	1000	50/40/35/30/27K
LED-DLJBX-TML-4R-15W-5CCT-BLK	120V	15w	1000	50/40/35/30/27K



## 2" LED Trimless Square Downlight

5-CCT Select

Box Qty: 18

Model	Voltage	Watts	Lumens	Color
LED-DLJBX-TML-2SQ-8W-5CCT-WH	120V	8w	600	50/40/35/30/27K
LED-DLJBX-TML-2SQ-8W-5CCT-BLK	120V	8w	600	50/40/35/30/27K
LED-DLJBX-TML-2SQ-15W-5CCT-WH	120V	15w	1000	50/40/35/30/27K
LED-DLJBX-TML-2SQ-15W-5CCT-BLK	120V	15w	1000	50/40/35/30/27K



## 4" LED Trimless Square Downlight

5-CCT Select

Box Qty: 18

Model	Voltage	Watts	Lumens	Color
LED-DLJBX-TML-4SQ-15W-5CCT-WH	120V	15w	1000	50/40/35/30/27K
LED-DLJBX-TML-4SQ-15W-5CCT-BLK	120V	15w	1000	50/40/35/30/27K

Pre-installed Accessory Model	Description
Add '-EMB-' to model #	Emergency Backup (External 15W)





### 3" LED J-Box Canless Downlight

- External J-Box Eliminates Recessed Can
- New Construction Mounting Plate Available
- Suitable for Use in Wet Locations
- Mix or Match Inner & Outer Trim Styles
- IC & Airtight-Rated Fixture
- EMB: Emergency Back Up: 90 minutes

#### 5-CCT Select



NEW Model	Voltage	Watts	Lumens	Color
LED-MDJBX-3-10W-5CCT-WH-R	120V	10w	800	50/40/35/30/27K

NEW Accessory	Description
MDJBX-3-TRIM-WH-SQ	MDJBX-3: White Square Smooth Trim
MDJBX-3-TRIM-BLK-R	MDJBX-3: Black Round Smooth Trim
MDJBX-3-TRIM-BLK-SQ	MDJBX-3: Black Square Smooth Trim

Pre-installed Accessory Model	Description
Add '-EMB-' to model #	Emergency Backup (External 15W)



White (-WH-SQ)



Black (-BLK-R)



Black (-BLK-SQ)



### 4" LED J-Box Canless Downlight

#### 5-CCT Select



NEW Model	Voltage	Watts	Lumens	Color
LED-MDJBX-4-15W-5CCT-WH-R	120V	15w	1300	50/40/35/30/27K

NEW Accessory	Description
MDJBX-4-TRIM-WH-SQ	MDJBX-3: White Square Smooth Trim
MDJBX-4-TRIM-BLK-R	MDJBX-3: Black Round Smooth Trim
MDJBX-4-TRIM-BLK-SQ	MDJBX-3: Black Square Smooth Trim

Pre-installed Accessory Model	Description
Add '-EMB-' to model #	Emergency Backup (External 15W)



White (-WH-SQ)



Black (-BLK-R)



Black (-BLK-SQ)



## 1" LED J-Box Canless Downlight

- External J-Box Eliminates Recessed Can
- New Construction Mounting Plate Available
- Suitable for Use in Wet Locations
- Mix or Match Inner & Outer Trim Styles
- IC & Airtight-Rated Fixture
- EMB: Emergency Back Up: 90 minutes



### 5-CCT Select

Model	Voltage	Watts	Lumens	Color
LED-DLJBX-1RG-7W-5CCT-WH-R	120V	7w	550	50/40/35/30/27K



## 2" LED J-Box Canless Downlight

### 5-CCT Select

Box Qty. 18

Model	Voltage	Watts	Lumens	Color
LED-DLJBX-2-8W-5CCT-W/W-SM	120V	8w	600	50/40/35/30/27K



### 5-CCT Select-Fire Rated

Box Qty. 18

Model	Voltage	Watts	Lumens	Color
LED-DLJBX-2-8W-5CCT-FR-WW-SM	120V	8w	600	50/40/35/30/27K



## 2" LED J-Box Canless Downlight

### Warm Dimming

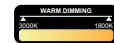

Box Qty. 18

Model	Voltage	Watts	Lumens	Color
LED-DLJBX-2-6W-3WD-W/W-S	120V	6w	450	30—>18k
LED-DLJBX-2-12W-3WD-W/W-S	120V	12w	850	30—>18k



## 2" LED J-Box Canless Downlight

### 5-CCT Select

Box Qty. 18

Model	Voltage	Watts	Lumens	Color
LED-DLJBX-2-15W-5CCT-W/W-S	120V	15w	1000	50/40/35/30/27K

### Single CCT

Box Qty. 18

Model	Voltage	Watts	Lumens	Color
LED-DLJBX-2-15W-27K-W/W-S	120V	15w	1000	2700k
LED-DLJBX-2-15W-30K-W/W-S	120V	15w	1000	3000k
LED-DLJBX-2-15W-40K-W/W-S	120V	15w	1000	4000k
LED-DLJBX-2-15W-50K-W/W-S	120V	15w	1000	5000k



**White (-WH-S)**  
Included  
(-WH-BFL)

**Black (-BLK-S)**  
(BLK-BFL)

**Bronze (-BZ-S)**  
(BZ-BFL)

**Chrome (-CH-S)**

**Nickel (-BN-S)**

**White (-WH-S)**  
(WH-BFL)

**Black (-BLK-S)**  
(BLK-BFL)

**Bronze (-BZ-S)**  
(BZ-BFL)

**Nickel (-BN-S)**

## 1" LED J-Box Canless Trim

Accessory	Description
DLJBX-1-TRIM-WH-SQ	1" White Square Smooth Trim
DLJBX-1-TRIM-BLK-R	1" Black Round Smooth Trim
DLJBX-1-TRIM-BLK-SQ	1" Black Square Smooth Trim



## 2" LED J-Box Canless Trim

Accessory	Description
DLJBX-2-TRIM-BLK-S	2" Black In and Out Smooth Trim
DLJBX-2-TRIM-BL-BFL	2" Black In and Out Baffle Trim
DLJBX-2-TRIM-BZ-S	2" Bronze In and Out Smooth Trim
DLJBX-2-TRIM-BZ-BFL	2" Bronze In and Out Baffle Trim
DLJBX-2-TRIM-BN-S	2" Brushed Nickel In and Out Smooth Trim
DLJBX-2-TRIM-CH-S	2" Chrome In and Out Smooth Trim
DLJBX-2-TRIM-WH-BFL	2" White In and Out Baffle Trim
DLJBX-2-TRIM-BN-S-SQ	2" Brushed Nickel Smooth Square Trim
DLJBX-2-TRIM-BL-S-SQ	2" Black Smooth Square Trim
DLJBX-2-TRIM-BZ-SQ	2" Bronze Smooth Square Trim
DLJBX-2-TRIM-WH-S-SQ	2" White Smooth Square Trim

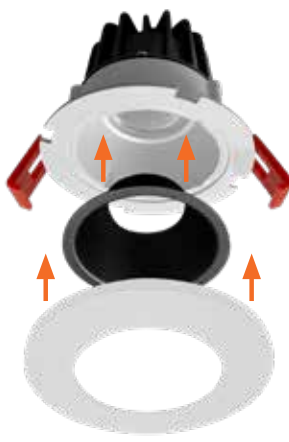



## 2" LED Snaptrim Adjustable Downlight

- External J-Box Eliminates Recessed Can
- New Construction Mounting Plate Available
- 35° tilt and up to 360° rotation
- Suitable for Use in Wet Locations
- IC & Airtight-Rated Fixture

### 5-CCT Select

Box Qty. 18

Model	Voltage	Watts	Lumens	Color
LED-DLJBX-ADJ-2-5W-5CCT-WH	120V	5w	350	50/40/35/30/27K

### 12V Version

Use Electronic Low Voltage drivers see CV series

Box Qty. 18

Model	Voltage	Watts	Lumens	Color
LED-DLJBX-ADJ-2-5W-30K-WH-12V	12V	5w	350	3000k
LED-DLJBX-ADJ-2-5W-30K-BLK-12V	12V	5w	350	3000k

### 120V Version

Box Qty. 18

Model	Voltage	Watts	Lumens	Color
LED-DLJBX-ADJ-2-5W-27K	120V	5w	350	2700k
LED-DLJBX-ADJ-2-5W-40K	120V	5w	350	4000k
LED-DLJBX-ADJ-2-5W-50K	120V	5w	350	5000k

Accessory	Description
JBX-EXT-6'-2PIN	6' Extension Cable for fixture to J-Box
JBX-EXT-10'-2PIN	10' Extension Cable for fixture to J-Box



## 3" LED Snaptrim Adjustable Downlight

- External J-Box Eliminates Recessed Can
- New Construction Mounting Plate Available
- 35° tilt and up to 360° rotation
- Suitable for Use in Wet Locations
- IC & Airtight-Rated Fixture
- EMB: Emergency Back Up: 90 minutes

### 5-CCT Select

Box Qty. 18

Model	Voltage	Watts	Lumens	Color
LED-DLJBX-ADJ-3-8W-5CCT-WH-R	120V	8w	600	50/40/35/30/27K
LED-DLJBX-ADJ-3-8W-5CCT-BLK-R	120V	8w	600	50/40/35/30/27K

### 5-CCT Select

Box Qty. 18

Model	Voltage	Watts	Lumens	Color
LED-DLJBX-ADJ-3-12W-5CCT-WH-R	120V	12w	1000	50/40/35/30/27K
LED-DLJBX-ADJ-3-12W-5CCT-BLK-R	120V	12w	1000	50/40/35/30/27K

### Warm Dimming

Box Qty. 18

Model	Voltage	Watts	Lumens	Color
LED-DLJBX-ADJ-3-6W-3WD-WH-R	120V	6w	450	30--->18k
LED-DLJBX-ADJ-3-6W-3WD-BLK-R	120V	6w	450	30--->18k



Accessory	Description
DLJBX-ADJ-3-TRIM-WH-SQ	3" Gimbal Square Trim White Finish
DLJBX-ADJ-3-TRIM-BN-R	3" Gimbal Round Trim Brushed Nickel
DLJBX-ADJ-3-TRIM-BN-SQ	3" Gimbal Square Trim Brushed Nickel
DLJBX-ADJ-3-TRIM-BLK-SQ	3" Gimbal Square Trim Black Finish

35° Tilt      360° Rotation



### 3" Regressed Gimbal Adjustable Downlight

- External j-box & spring mount clips for easy installation
- Compatible with most dimmers (e.g. Lutron DVCL-153P)

#### 5-CCT Select

SELECT SWITCH DIMMABLE 90 HIGH CRI JAB TITLE 24 COMPLIANT Box Qty. 18

Model	Voltage	Watts	Lumens	Color
LED-DLJBX-ADJ-3RG-8W-5CCT-WH-R	120V	8w	600	50/40/35/30/27K
LED-DLJBX-ADJ-3RG-8W-5CCT-BLK-R	120V	8w	600	50/40/35/30/27K
<b>NEW</b> LED-DLJBX-ADJ-3RG-8W-5CCT-WH-SQ	120V	8w	600	50/40/35/30/27K
<b>NEW</b> LED-DLJBX-ADJ-3RG-8W-5CCT-BLK-SQ	120V	8w	600	50/40/35/30/27K

Accessory	Description
Add '-EMB-' to model #	Emergency Backup (External 25W)
CUNV-NC-ICAT	2/3/4/6" Universal Pre-Mounting New Construction Plate
JBX-EXT-6"-2PIN	6" Extension Cable for fixture to J-Box Unit
JBX-EXT-10"-2PIN	10" Extension Cable for fixture to J-Box Unit



### 2" SnapTrim Floating Adjustable J-Box

- 360° Twist allows for an easy adjustment after installation
- Unique floating gimbal design adds an architectural touch
- Canless module does not require a housing making it perfect for new construction and remodeling.

#### 5-CCT Select

SELECT SWITCH DIMMABLE 90 HIGH CRI JAB TITLE 24 COMPLIANT Box Qty. 18

Model	Voltage	Watts	Lumens	Color
LED-SL-FLT-2-5W-5CCT-WH	120V	5w	400	50/40/35/30/27K
LED-SL-FLT-2-5W-5CCT-BLK	120V	5w	400	50/40/35/30/27K

Accessory	Description
Add '-EMB-' to model #	Emergency Backup (External 25W)

### 4" SnapTrim Floating Adjustable J-Box

#### 5-CCT Select

Box Qty. 18

Model	Voltage	Watts	Lumens	Color
LED-SL-FLT-4R-9W-5CCT-WH	120V	9w	700	50/40/35/30/27K

#### 5-CCT Select - Fire Rated

Box Qty. 18

Model	Voltage	Watts	Lumens	Color
LED-SL-FLT-4R-9W-5CCT-FR-WH	120V	9w	700	50/40/35/30/27K

Accessory	Description
Add '-EMB-' to model #	Emergency Backup (External 25W)

### 4" Round Scoop Downlight J-Box

#### 5-CCT Select

Box Qty. 18

Model	Voltage	Watts	Lumens	Color
LED-SL-SCP-4R-12W-5CCT-WH	120V	12w	900	50/40/35/30/27K

Accessory	Description
Add '-EMB-' to model #	Emergency Backup (External 25W)

### 4" Regressed Gimbal Adjustable Sloped Ceiling J-Box

#### 5-CCT Select

SELECT SWITCH DIMMABLE 90 HIGH CRI JAB TITLE 24 COMPLIANT Box Qty. 18

Model	Voltage	Watts	Lumens	Color
LED-SL-SLP-ADJ-4R-8W-5CCT-WH	120V	8w	600	50/40/35/30/27K
LED-SL-SLP-ADJ-4R-8W-5CCT-BLK	120V	8w	600	50/40/35/30/27K

Accessory	Description
Add '-EMB-' to model #	Emergency Backup (External 25W)

### 3" Regressed Downlight

- External j-box & spring mount clips for easy installation
- Compatible with most dimmers (e.g. Lutron DVCL-153P)

#### 5-CCT Select

Box Qty. 18

Model	Voltage	Watts	Lumens	Color
LED-DLJBX-3RG-15W-5CCT-WH-R	120V	15w	1100	50/40/35/30/27K

Accessory	Description
Add '-EMB-' to model #	Emergency Backup (External 25W)
DLJBX-3RG-TRIM-WH-SQ	3" Regressed White Square Trim
DLJBX-3RG-TRIM-BLK-R	3" Regressed Black Round Trim
DLJBX-3RG-TRIM-BLK-SQ	3" Regressed Black Square Trim



### 4" Regressed Downlight

#### 5-CCT Select

Box Qty. 18

Model	Voltage	Watts	Lumens	Color
LED-DLJBX-4RG-18W-5CCT-WH-R	120V	18w	1500	50/40/35/30/27K
LED-DLJBX-4RG-15W-5CCT-WH-R	120V	15w	1000	50/40/35/30/27K
LED-DLJBX-4RG-15W-5CCT-WH-R-0/10V	120-277V	15w	1100	50/40/35/30/27K

#### 5-CCT Select - Fire Rated

Box Qty. 18

Model	Voltage	Watts	Lumens	Color
LED-DLJBX-4RG-15W-5CCT-FR-WH-R	120V	18w	1500	50/40/35/30/27K

#### Warm Dimming

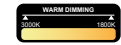

Box Qty. 18

Model	Voltage	Watts	Lumens	Color
LED-DLJBX-4RG-12W-3WD-WH-R	120V	12w	850	30-->18k

Accessory	Description
Add '-EMB-' to model #	Emergency Backup (External 25W)
DLJBX-4RG-TRIM-WH-SQ	4" Regressed Gimbal White Square Trim
DLJBX-4RG-TRIM-BLK-R	4" Regressed Gimbal Black Round Trim
DLJBX-4RG-TRIM-BLK-SQ	4" Regressed Gimbal Black Square Trim
DLJBX-4RG-TRIM-BRZ-R	4" Regressed Gimbal Bronze Round Trim
DLJBX-4RG-TRIM-BRZ-SQ	4" Regressed Gimbal Bronze Square Trim

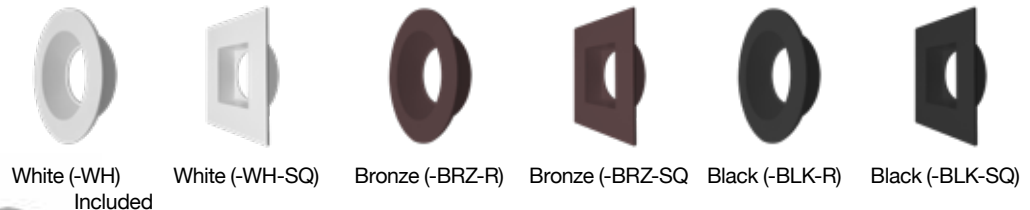

### 6" Regressed Downlight

#### 5-CCT Select

Box Qty. 18

Model	Voltage	Watts	Lumens	Color
LED-DLJBX-6RG-24W-5CCT-WH-R	120V	24w	1800	50/40/35/30/27K

Accessory	Description
Add '-EMB-' to model #	Emergency Backup (External 25W)
DLJBX-6RG-TRIM-WH-SQ	6" Regressed Gimbal White Square Trim
DLJBX-6RG-TRIM-BLK-R	6" Regressed Gimbal Black Round Trim
DLJBX-6RG-TRIM-BLK-SQ	6" Regressed Gimbal Black Square Trim

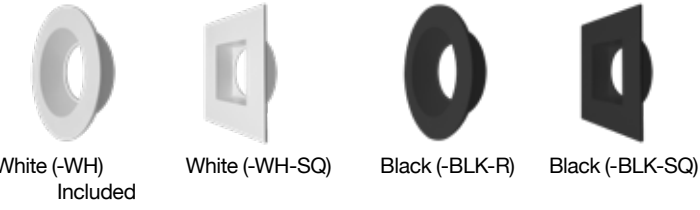



## 4" SnapTrim Adjustable Downlight

- External j-box & spring mount clips for easy installation
- Compatible with most dimmers (e.g. Lutron DVCL-153P)
- Canless module does not require housing

### 5-CCT Select

Model	Voltage	Watts	Lumens	Color
LED-DLJBX-ADJ-4-12W-5CCT-WH-R	120V	12w	750	50/40/35/30/27K
LED-DLJBX-ADJ-4-12W-5CCT-BLK-R	120V	12w	750	50/40/35/30/27K
LED-DLJBX-ADJ-4-12W-5CCT-BN-R	120V	12w	750	50/40/35/30/27K
<b>NEW</b> LED-DLJBX-ADJ-4-18W-5CCT-WH-R	120V	18w	1500	50/40/35/30/27K
<b>NEW</b> LED-DLJBX-ADJ-4-18W-5CCT-BLK-R	120V	18w	1500	50/40/35/30/27K

### Warm Dimming

Model	Voltage	Watts	Lumens	Color
LED-DLJBX-ADJ-4-12W-3WD-WH-R	120V	12w	750	30-->18k

Accessory	Description
JBX-EXT-6'-2PIN	6" Extension Cable for fixture to J-Box Unit
JBX-EXT-10'-2PIN	10" Extension Cable for fixture to J-Box Unit
Add '-EMB' to model #	Emergency Backup (External 25W)



Display featuring 10 of our canless downlights. Place a \$3,000+ stock orders of downlights and get a free counter display.

Display

## 6" SnapTrim Adjustable Downlight

### 5-CCT Select

Model	Voltage	Watts	Lumens	Color
LED-DLJBX-ADJ-6-18W-5CCT-WH-R	120V	18w	1500	50/40/35/30/27K
LED-DLJBX-ADJ-6-18W-5CCT-BLK-R	120V	18w	1500	50/40/35/30/27K

Accessory	Description
Add: -24D to Model #	24D Optic
Add: -60D to Model #	60D Optic
Add '-EMB' to model #	Emergency Backup (External 25W)

## Optic Lens Options



Accessory	Description
OPTIC-35X17-24D	60D Optic: DLJBX-2, DLJBX-TML-2
OPTIC-35X17-60D	60D Optic: DLJBX-2, DLJBX-TML-2
OPTIC-42X14-24D	24D Optic: DLJBX-ADJ-3, ADJ-3RG, SLP-ADJ-4R, TML-GMB-2R, SCP-4R
OPTIC-42X14-60D	60D Optic: DLJBX-ADJ-3, ADJ-3RG, SLP-ADJ-4R, TML-GMB-2R, SCP-4R
OPTIC-75X24-24D	24D Optic: DLJBX-ADJ-4
OPTIC-75X24-60D	60D Optic: DLJBX-ADJ-4
OPTIC-63X22-24D	24D Optic:DLJBX-4RG, SL-FLT-4R, DLJBX-TML-4, LED-SQM
OPTIC-63X22-60D	60D Optic:DLJBX-4RG, SL-FLT-4R, DLJBX-TML-4, SQM-TML
OPTIC-90X25-24D	24D Optic: LED-DLJBX-6RG
OPTIC-90X25-60D	60D Optic: LED-DLJBX-6RG



### 4" EXT SnapTrim Tilting Downlight

- Canless module does not require housing
- Fixture is adjustable up to 45°
- Accessories including color trims

#### 5-CCT Select



Model	Voltage	Watts	Lumens	Color
LED-SL-TLT-4R-9W-5CCT-WH	120V	9w	600	50/40/35/30/27K



#### 3-CCT Select

Box Qty. 18

Model	Voltage	Watts	Lumens	Color
LED-SL-TLT-4R-9W-TRI	120V	9w	600	50/40/30k



Pre-installed Accessory Model	Description
Add '-EMB' to model #	Emergency Backup (External 25W)



### 6" EXT SnapTrim Tilting Downlight

#### 5-CCT Select

Box Qty. 18

Model	Voltage	Watts	Lumens	Color
LED-SL-TLT-6R-12W-5CCT-WH	120V	12w	800	50/40/35/30/27K



#### 3-CCT Select

Box Qty. 18

Model	Voltage	Watts	Lumens	Color
LED-SL-TLT-6R-12W-TRI	120V	12w	800	50/40/30k



Pre-installed Accessory Model	Description
Add '-EMB' to model #	Emergency Backup (External 25W)



6' / 10' Extension Cable

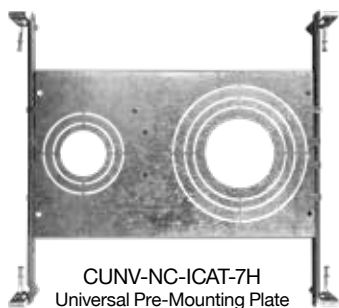

CUNV-NC-ICAT-7H  
Universal Pre-Mounting Plate  
13 7/8" x 15 1/8"

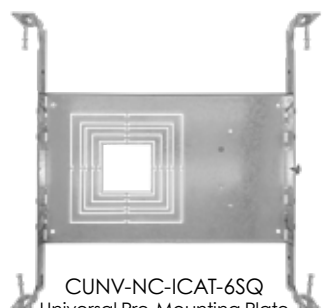

CUNV-NC-ICAT-6SQ  
Universal Pre-Mounting Plate  
14" x 13.75"

### Canless LED Downlight Accessories

Accessory	Description
CUNV-NC-ICAT-7H	1" / 2" / 3" / 3.5" / 4" / 6" Universal Pre-Mounting New Construction Plate
CUNV-NC-ICAT-6SQ	1" 2 3.5" 4" 5" 6" Canless Downlights (Only for Trimless Squares) New Construction Plate
CUNV-JBX-RI-XL	2" 3" 3.5" 4" 5" 6" Universal Construction Plate Canless Downlights
C4-JBX-RI	4" Rough In Plate
C6-JBX-RI	6" Rough In Plate
C8-JBX-RI	8" Rough In Plate
JBX-EXT-6'-2PIN	6' Extension Cable for fixture to J-Box
JBX-EXT-10'-2PIN	10' Extension Cable for fixture to J-Box
JBX-EXT-12'-2PIN	12' Extension Cable for fixture to J-Box
JBX-EXT-6'-TRI	6' Extension Cable for fixture to J-Box
JBX-EXT-10'-TRI	10' Extension Cable for fixture to J-Box



CUNV-JBX-RI-XL  
Universal Pre-Mounting Plate  
26" x 8.4"

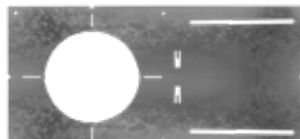

C4-JBX-RI  
4" Rough In Plate  
6 1/2" x 13 1/4"

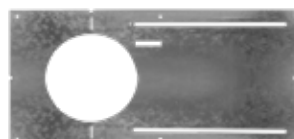

C6-JBX-RI  
6" Rough In Plate  
8 1/2" x 17 1/4"



C8-JBX-RI  
8" Rough In Plate  
10 1/2" x 26"





### 3" EXT SnapTrim Round Downlight

- Canless module does not require housing
- Check spec sheet for dimmer compatibility. Triac and 0-10V options are available.
- Accessories including color trims (see page 36)

#### 5-CCT Select

SELECT YOUR DIMMER

Model	Voltage	Watts	Lumens	Color
LED-SL-PNL-3R-8W-5CCT-WH	120V	8w	500	50/40/35/30/27K
LED-SL-PNL-3SQ-8W-5CCT-WH	120V	8w	500	50/40/35/30/27K



#### 5-CCT Select - Fire Rated

Box Qty. 18

Model	Voltage	Watts	Lumens	Color
LED-SL-PNL-4R-12W-5CCT-FR-WH	120V	12w	840	50/40/35/30/27K



#### 5-CCT & 3-Power Select

Box Qty. 18

Model	Voltage	Watts	Lumens	Color
LED-SL-PNL-4R-3P12W-5CCT-WH	120V	8/10/12w	500/700/840	50/40/35/30/27K



#### 12V Version

Use Electronic Low Voltage drivers see CV series

Box Qty. 18

**NEW**

Model	Voltage	Watts	Lumens	Color
LED-SL-PNL-4R-9W-5CCT-12V	120V	9w	750	50/40/35/30/27K



#### 3-CCT Select 0-10V

Box Qty. 18

Model	Voltage	Watts	Lumens	Color
LED-SL-PNL-4R-11W-TRI-0/10V	120/277V	11w	750	50/40/30k



Pre-installed Accessory Model	Description
Add '-EMB' to model #	Emergency Backup (External 25W)



### 4" EXT SnapTrim Square Downlight

#### 5-CCT Select - Fire Rated

Box Qty. 18

**NEW**

Model	Voltage	Watts	Lumens	Color
LED-SL-PNL-4SQ-12W-5CCT-FR-WH	120V	12w	840	50/40/35/30/27K



#### 5-CCT & 3-Power Select

Box Qty. 18

Model	Voltage	Watts	Lumens	Color
LED-SL-PNL-4SQ-3P12W-5CCT-WH	120V	8/10/12w	500/700/840	50/40/35/30/27K



#### 5-CCT Select

Box Qty. 18

Model	Voltage	Watts	Lumens	Color
LED-SL-PNL-4SQ-11W-5CCT-0/10V	120/277V	11w	750	50/40/35/30/27K



Pre-installed Accessory Model	Description
Add '-EMB' to model #	Emergency Backup (External 25W)



## 6" EXT SnapTrim Round Downlight

5-CCT & 3-Power Select

Box Qty. 18

Model	Voltage	Watts	Lumens	Color
LED-SL-PNL-6R-3P15W-5CCT-WH	120V	15/12/9w	1150/950/750	50/40/35/30/27K

5-CCT Select - Fire Rated

Box Qty. 18

Model	Voltage	Watts	Lumens	Color
LED-SL-PNL-6R-15W-5CCT-FR-WH	120V	15w	1150	50/40/35/30/27K

## 6" EXT SnapTrim Square Downlight

5-CCT Select

Box Qty. 18

Model	Voltage	Watts	Lumens	Color
LED-SL-PNL-6SQ-15W-5CCT-WH	120V	15w	1050	50/40/35/30/27K

5-CCT & 3-Power Select

Box Qty. 18

Model	Voltage	Watts	Lumens	Color
LED-SL-PNL-6SQ-3P15W-5CCT-WH	120V	9/12/15w	1150/950/750	50/40/35/30/27K

3-CCT Select

Box Qty. 18

Model	Voltage	Watts	Lumens	Color
LED-SL-PNL-6SQ-14W-TRI	120V	14w	1000	50/40/30k
LED-SL-PNL-6SQ-14W-TRI-0/10V	120/277V	14w	1000	50/40/30k

5-CCT Select - Fire Rated

Box Qty. 18

Model	Voltage	Watts	Lumens	Color
LED-SL-PNL-6SQ-15W-5CCT-FR-WH	120V	15w	1150	50/40/35/30/27K

Pre-installed Accessory Model Description

Add '-EMB' to model # Emergency Backup (External 25W)

## 8" EXT SnapTrim Square Downlight

5-CCT & 3-Power Select

Box Qty. 18

Model	Voltage	Watts	Lumens	Color
LED-SL-PNL-8SQ-3P22W-5CCT-WH	120V	16/19/22w	1600/1400/1200	50/40/35/30/27K

## 8" EXT SnapTrim Round Downlight

5-CCT & 3-Power Select

Box Qty. 18

Model	Voltage	Watts	Lumens	Color
LED-SL-PNL-8R-22W-5CCT-0/10V	120-277V	22w	1600	50/40/35/30/27K

5-CCT & 3-Power Select

Box Qty. 18

Model	Voltage	Watts	Lumens	Color
LED-SL-PNL-8R-3P22W-5CCT-WH	120V	16/19/22w	1600/1400/1200	50/40/35/30/27K

3-CCT Select

Box Qty. 18

Model	Voltage	Watts	Lumens	Color
LED-SL-PNL-8R-18W-TRI	120V	18w	1200	50/40/30k
LED-SL-PNL-8R-18W-TRI-0/10v	120/277V	18w	1200	50/40/30k

Pre-installed Accessory Model Description

Add '-EMB' to model # Emergency Backup (External 25W)

## 10" EXT SnapTrim Round Downlight

3-CCT Select 0-10V

Box Qty. 18

Model	Voltage	Watts	Lumens	Color
LED-SL-PNL-10R-22W-TRI-0/10v	120/277V	22w	1600	50/40/30k

Pre-installed Accessory Model Description

Add '-EMB' to model # Emergency Backup (External 25W)





CUNV-SQM-NC-ICAT  
Universal Pre-Mounting Plate  
14 3/4" x 11 3/4"

### 4" Multiple Head Downlights

- Beam angle 38° standard, 24° and 60° available
- 360° rotation and 35° tilt gimble light source
- External j-box & spring mount clips for easy installation
- Canless module does not require housing

#### Single Head

SELECT OR SWITCH DIMMABLE 90 HIGH CRI JA8 TITLE 24 COMPLIANT ENERGY STAR Box Qty. 18

Model	Voltage	Watts	Lumens	Color
LED-SQM1-4-15W-5CCT-WH	120V	15w	1000	50/40/35/30/27K
LED-SQM1-4-15W-5CCT-BLK	120V	15w	1000	50/40/35/30/27K

#### Double Head

Box Qty. 8

Model	Voltage	Watts	Lumens	Color
LED-SQM2-4-30W-5CCT-WH	120V	30w	2000	50/40/35/30/27K
LED-SQM2-4-30W-5CCT-BLK	120V	30w	2000	50/40/35/30/27K

#### Triple Head

Box Qty. 8

Model	Voltage	Watts	Lumens	Color
LED-SQM3-4-45W-5CCT-WH	120V	45w	3000	50/40/35/30/27K
LED-SQM3-4-45W-5CCT-BLK	120V	45w	3000	50/40/35/30/27K

Pre-installed Accessory Model	Description
Add: -24D to Model #	24D Optic
Add: -60D to Model #	60D Optic
Add '-EMB' to model #	Emergency Backup (External 25W)

Accessory	Description
CUNV-SQM-NC-ICAT	New Construction Plate: SQM Fixtures

### 4" Trimless Multiple Head Downlights

- Beam angle 20° standard, 38° and 60° available
- 360° rotation and 35° tilt gimble light source
- Canless module does not require housing

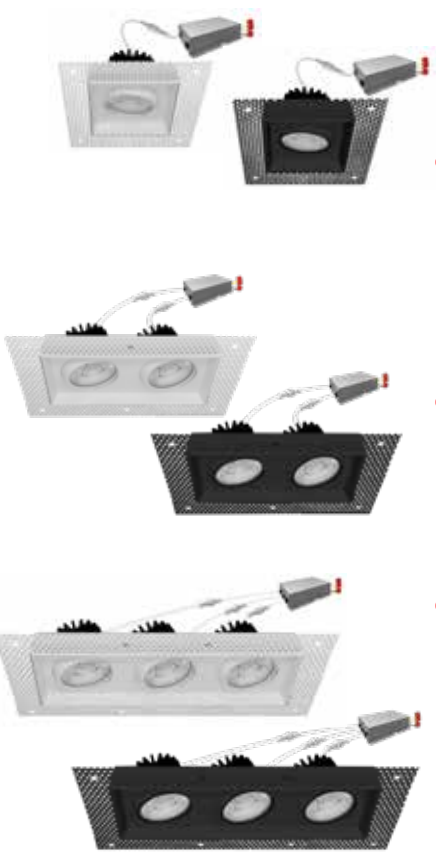

#### Single Head

SELECT OR SWITCH DIMMABLE 90 HIGH CRI JA8 TITLE 24 COMPLIANT ENERGY STAR Box Qty. 18

Model	Voltage	Watts	Lumens	Color
LED-SQM1-TML-4-15W-5CCT-WH-20	120V	15w	1000	50/40/35/30/27K
LED-SQM1-TML-4-15W-5CCT-BLK-20	120V	15w	1000	50/40/35/30/27K

#### Double Head

Box Qty. 8

Model	Voltage	Watts	Lumens	Color
LED-SQM2-TML-4-30W-5CCT-WH-20	120V	30w	2000	50/40/35/30/27K
LED-SQM2-TML-4-30W-5CCT-BLK-20	120V	30w	2000	50/40/35/30/27K

#### Triple Head

Box Qty. 8

Model	Voltage	Watts	Lumens	Color
LED-SQM3-TML-4-45W-5CCT-WH-20	120V	45w	3000	50/40/35/30/27K
LED-SQM3-TML-4-45W-5CCT-BLK-20	120V	45w	3000	50/40/35/30/27K

Pre-installed Accessory Model	Description
Add: -38D to Model #	38D Optic
Add: -60D to Model #	60D Optic
Add '-EMB' to model #	Emergency Backup (External 25W)

## SnapTrim LED Downlight Accessories



J-Box



LED-EMB-25W-HV-0/10V



6' / 10' Extension Cable

Accessory	Description
JBX-11W-HV-0/10V	SL-PNL-4SQ 120/277V 0-10V Driver
JBX-11W-277-347V	SL-PNL-4SQ 277-347V Driver
JBX-14W-HV-0/10V	SL-PNL-6SQ 120/277V 0-10V Driver
JBX-14W-277-347V	SL-PNL-6SQ 277-347V Driver
JBX-18W-277-347V	SL-PNL-8R 277-347V Driver
CUNV-NC-ICAT-7H	1" 2" 3" 3.5" 4" 5" 6" Universal Pre-Mounting New Construction Plate
CUNV-NC-ICAT	2" 3" 4" 6" Universal Pre-Mounting New Construction Plate
CUNV-JBX-RI-XL	2" 3" 3.5" 4" 5" 6" Universal Construction Plate: Canless Downlights
CUNV-NC-ICAT-6SQ	1" 2 3.5" 4" 5" 6" New Construction Plate: Canless Downlights (Only for Trimless Squares)
C4-JBX-RI	4" Rough In Plate
CUNV-SQM-NC-ICAT	New Construction Plate: SQM Fixtures
C6-JBX-RI	6" Rough In Plate
C8-JBX-RI	8" Rough In Plate
JBX-EXT-6'-TRI	6' Extension Cable for fixture to J-Box
JBX-EXT-10'-TRI	10' Extension Cable for fixture to J-Box

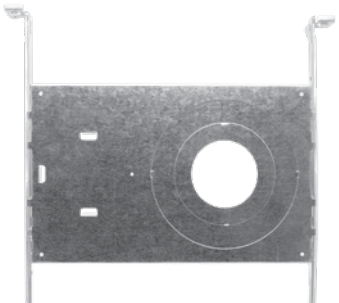

CUNV-NC-ICAT  
Universal Pre-Mounting Plate  
5 3/10" x 14 1/2"



CUNV-JBX-RI-XL  
Universal Pre-Mounting Plate  
8.4" x 26"

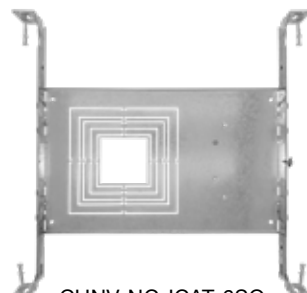

CUNV-NC-ICAT-6SQ  
Universal Construction Plate  
14" x 13.75"

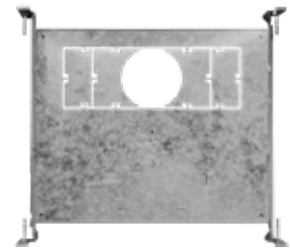

CUNV-SQM-NC-ICAT  
Universal Pre-Mounting Plate  
14 3/4" x 11 3/4"

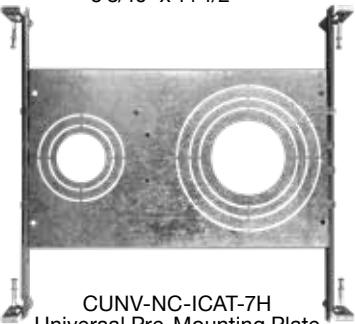

CUNV-NC-ICAT-7H  
Universal Pre-Mounting Plate  
13 7/8" x 15 1/8"

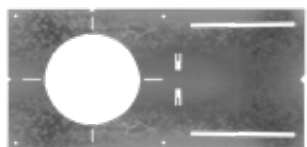

C4-JBX-RI  
4" Rough In Plate  
6 1/2" x 13 1/4"

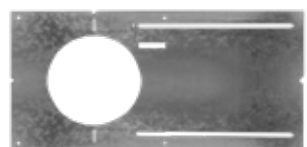

C6-JBX-RI  
6" Rough In Plate  
8 1/2" x 17 1/4"



C8-JBX-RI  
8" Rough In Plate  
10 1/2" x 26"



BLK      BZ      BN

BLK      BZ      BN

## SLPNL Trims for TRI & 3 Power + 5CCT Models

Accessory	Description
SLPNL-TRIM-3R-BLK	3" Round Black Trim
SLPNL-TRIM-3R-BRZ	3" Round Bronze Trim
SLPNL-TRIM-3R-BNI	3" Round Brushed Nickel Trim
SLPNL-TRIM-4R-BLK	4" Round Black Trim
SLPNL-TRIM-4R-BRZ	4" Round Bronze Trim
SLPNL-TRIM-4R-BNI	4" Round Brushed Nickel Trim
SLPNL-TRIM-4SQ-BLK	4" Square Black Trim
SLPNL-TRIM-4SQ-BRZ	4" Square Bronze Trim

Accessory	Description
SLPNL-TRIM-4SQ-BNI	4" Square Brushed Nickel Trim
SLPNL-TRIM-6R-BLK	6" Round Black Trim
SLPNL-TRIM-6R-BRZ	6" Round Bronze Trim
SLPNL-TRIM-6R-BNI	6" Round Brushed Nickel Trim
SLPNL-TRIM-6SQ-BLK	6" Square Black Trim
SLPNL-TRIM-6SQ-BRZ	6" Square Bronze Trim
SLPNL-TRIM-6SQ-BNI	6" Square Brushed Nickel Trim



## 4" / 6" / 8" / 10" Commercial Downlight

- 4" & 6": TRI mode dimming: 0-10V, Triac, ELV down to 5%
- 8" & 10": 0-10V dimmable down to 5%
- 27" flex whip included on each fixture

### 5-CCT & 3-Power Select



Model	Voltage	Watts	Lumens	Color
LED-CMD-4-3M19-5CCT-UNV	120-277V	19/14/9	See Chart	50/40/35/30/27k
LED-CMD-6-3M19-5CCT-UNV	120-277V	19/13/9w	See Chart	50/40/35/30/27k
<b>NEW</b> LED-CMD-6-3M30-5CCT-CUNV	120-277V	30/20/15w	See Chart	50/40/35/30/27k
LED-CMD-8-3M29-5CCT-UNV	120-277V	29/23/16.5w	See Chart	50/40/35/30/27k
<b>NEW</b> LED-CMD-8-3M36-5CCT-CUNV	120-277V	22/32/36w	See Chart	50/40/35/30/27k
LED-CMD-10-3M38-5CCT-UNV	120-277V	38/30/21w	See Chart	50/40/35/30/27k

4-3M19		6-3M19	
WATT	LUMENS	WATT	LUMENS
9	750	9	800
14	1,000	14	1,200
19	1,500	19	1,600

6-3M30		8-3M29	
WATT	LUMENS	WATT	LUMENS
15	1,500	16.5	1,500
20	2,000	23	2,000
30	3,000	29	2,500

8-3M36		10-3M38	
WATT	LUMENS	WATT	LUMENS
21	2,500	21	2,000
30	3,500	30	2,500
38	3,900	38	3,300

### Wall Wash Trims

- 85° beam angle

Box Qty. 24

Accessory	Description
CMD-4-WASH-WH	4" CMD: Wall Wash Trim
CMD-6-WASH-WH	6" CMD: Wall Wash Trim
CMD-8-WASH-WH	8" CMD: Wall Wash Trim

### Trim Accessories for CMD-3M Series

Box Qty. 12

Accessory	Description
CMD-TRIM-4-HZ-SM	4" Clear-Specular Haze Reflector
CMD-TRIM-4-BLK-SM	4" Black Reflector
CMD-TRIM-6-HZ-SM	6" Clear-Specular Haze Reflector
CMD-TRIM-6-BLK-SM	6" Black Reflector
CMD-TRIM-8-HZ-SM	8" Clear-Specular Haze Reflector
CMD-TRIM-8-BLK-SM	8" Black Reflector
CMD-TRIM-10-HZ-SM	10" Clear-Specular Haze Reflector
CMD-TRIM-10-BLK-SM	10" Black Reflector

### Accessories for CMD-3M Series

Accessory Model	Description
GR-4-WH	4" Goof Ring, Inner Dim: 4" Outer Dim: 8"
GR-6-WH	6" Goof Ring, Inner Dim: 6.3" Outer Dim: 10.5"
GR-8-WH	8" Goof Ring, Inner Dim: 8" Outer Dim: 12.5"
GR-10-WH	10" Goof Ring, Inner Dim: 9" Outer Dim: 14.1"
JBOX-ALM	Junction Box (6 Knock-Outs)
CUNV-NC-RI-J-JBX	4/6/8/10" Commercial New Construction Plate with Joist Bar + J-Box
LED-EMB-25W-HV-0/10V	Emergency Back Up For Internal Drivers (Works with all 0-10V Dim or <25W fixtures)

Pre-installed Accessory Model	Description
Add '-EMB' to model #	Emergency Backup (External 25W)

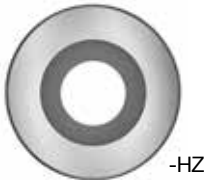

CUNV-NC-RI-J-JBX  
Universal Construction Plate  
21" x 17"



## 4" / 6" / 8" / 10" Commercial Downlight Module

- Choose between 3 wattages
  - ETL listed for USA and CA, Energy Star Certified
  - 120-277V, 50-60Hz driver
  - 24°-45° field adjustable beam angle, in 5° increments
  - Must purchase trim for each module
  - 4" trim is only compatible with 3M20, 3M30 and 3M35 only
- 5-CCT & Single CCT w/ 3-Power Select



Box Qty. 6



3M20

3M30

WATT	LUMENS	WATT	LUMENS
9	750	13	1,250
14	1,000	20	2,000
19	1,500	35	3,000

3M35

3M55

WATT	LUMENS	WATT	LUMENS
13	1,250	32	3,200
20	2,000	40	4,000
35	3,000	55	5,000



-CSH



-WH



-BLK



-SQ

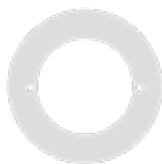

GR



J-BOX ALM  
4.46" W x 3.04" D x 1.37" H

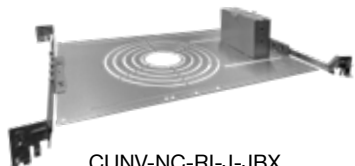

CUNV-NC-RI-J-JBX  
21.2" W x 12" D x 1.6"H  
(Assembly Required)

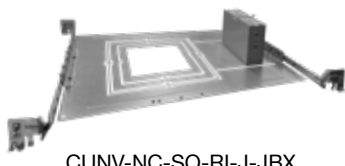

CUNV-NC-SQ-RI-J-JBX  
21.2" W x 12" D x 1.6"H  
(Assembly Required)

## 4" / 6" / 8" / 10" Commercial Downlight Trims

Box Qty. 6

Model	Description
CADM-4-CSH	4" Clear-Specular Haze Reflector/White Trim (3M20, 3M30 & 3M35 only)
<b>NEW</b> CADM-4-CSH-BLK	4" Clear-Specular Haze Reflector/Black Trim (3M20, 3M30 & 3M35 only)
CADM-4-CSH-SQ	4" Clear-Specular Haze Reflector/White Square Trim (3M20, 3M30 & 3M35 only)
CADM-4-WH	4" White Reflector + Trim (3M20 & 3M35 only)
CADM-6-CSH	6" Clear-Specular Haze Reflector/White Trim
<b>NEW</b> CADM-6-CSH-BLK	6" Clear-Specular Haze Reflector/Black Trim
CADM-6-CSH-SQ	6" Clear-Specular Haze Reflector/White Square Trim (3M20, 3M30 & 3M35 only)
CADM-6-WH	6" White Reflector + Trim
CADM-8-CSH	8" Clear-Specular Haze Reflector/White Trim
<b>NEW</b> CADM-8-CSH-BLK	8" Clear-Specular Haze Reflector/Black Trim
CADM-8-CSH-SQ	8" Clear-Specular Haze Reflector/White Square Trim (3M20, 3M30 & 3M35 only)
CADM-8-WH	8" White Reflector + Trim
CADM-10-CSH	10" Clear-Specular Haze Reflector/White Trim
CADM-10-WH	10" White Reflector + Trim

\* Custom color trims are available

## Accessories for CADM Series

Accessory Model	Description
GR-4-WH	4" Goof Ring, Inner Dim: 4.9" Outer Dim: 6.5"
GR-6-WH	6" Goof Ring, Inner Dim: 6.3" Outer Dim: 10.5"
GR-8-WH	8" Goof Ring, Inner Dim: 8" Outer Dim: 12.5"
GR-10-WH	10" Goof Ring, Inner Dim: 9" Outer Dim: 14.1"
JBOX-ALM	Junction Box (6 Knock-Outs)
<b>NEW</b> CUNV-NC-RI-J-JBX	New Construction Plate: 4" 6" 8" 10" CADM or CMD Round
<b>NEW</b> CUNV-NC-SQ-J-JBX	New Construction Plate: 4" 6" 8" CADM Square
C6-NC-RI-J-JBX	6" Commercial New Construction Plate with Joist Bar + J-Box
C8/10-NC-RI-J-JBX	8/10" Commercial New Construction Plate with Joist Bar + J-Box





### 4" SnapTrim Baffle Downlight

- Baffled trim design
- Integrated j-box & spring mount clips for easy installation
- Compatible with most dimmers (e.g. Lutron DVCL-153P)
- Canless module does not require housing

#### 5-CCT Select

Box Qty. 12

Model	Voltage	Watts	Lumens	Color
LED-DLJBX-4B-11W-5CCT-WH	120V	11w	750	50/40/35/30/27K

### 6" SnapTrim Baffle Downlight

#### 5-CCT Select

Box Qty. 12

Model	Voltage	Watts	Lumens	Color
LED-DLJBX-6B-15W-5CCT-WH	120V	14w	1000	50/40/35/30/27K

### 4" SnapTrim Downlight

#### Single CCT

Box Qty. 12



Final Production

Final Production

Final Production

Model	Voltage	Watts	Lumens	Color
LED-DLJBX-4B-7W-30K	120V	7w	550	3000k
LED-DLJBX-4B-7W-40K	120V	7w	550	4000k
LED-DLJBX-4B-7W-50K	120V	7w	550	5000k

### 6" SnapTrim Downlight

#### Single CCT

Box Qty. 12

Final Production

Model	Voltage	Watts	Lumens	Color
LED-DLJBX-6B-9W-27K	120V	9w	650	2700k





4"



5/6"



## Smart Downlight RGB+W

- RGB+W Technology: Tunable from 27K-50K + RGB colors
- Dimmable and controllable via Bluetooth from your smartphone
- Music Mode: RGB Colors dance to music
- Suitable for retrofit or new construction
- Set timing schedule and group fixtures together
- Connect to multiple phones
- Control your lights with WIFI

## 4" Smart Downlight RGB+W



Model	Voltage	Watts	Lumens	Color
LED-ECODL-4-10W-RGB+W	120V	10.5w	800	RGB+W

## 5/6" Smart Downlight RGB+W

Box Qty.  
12

Model	Voltage	Watts	Lumens	Color
LED-ECODL-5/6-12W-RGB+W	120V	12w	1000	RGB+W

Pre-installed Accessory Model	Description
Add '-EMB-' to model #	Emergency Backup (External 25W)

## 4" SnapTrim Round Downlight RGB+W

Box Qty.  
18

Model	Voltage	Watts	Lumens	Color
LED-SL-PNL-4R-9W-RGB+W-WH	120V	9w	600	RGB+W

## 6" SnapTrim Round Downlight RGB+W

Box Qty.  
18

Model	Voltage	Watts	Lumens	Color
LED-SL-PNL-6R-12W-RGB+W-WH	120V	12w	1000	RGB+W

## 6" Cusp Disk RGB+W

Box Qty.  
20

Model	Voltage	Watts	Lumens	Color
LED-CDSK-6-15W-RGB+W-WH	120V	15w	1000	RGB+W

## 7" Round Slimline Disk RGB+W

Box Qty.  
20

Model	Voltage	Watts	Lumens	Color
LED-SLDSKR-7-15W-RGB+W-WH	120V	15w	1000	RGB+W

Envision  
CONNECTDownload on  
APP STORE

COLOR



WHITE



SCENE



MUSIC RHYTHM



## 4" & 5/6" RDL Downlights

### Internal J-Box

- Canless model, no housing required
- Triac dimmable down to 5%



Model	Voltage	Watts	Lumens	Color
LED-RDL-JBX-4-11W-5CCT-WH-SM	120V	11w	750lm	50/40/35/30/27K
LED-RDL-JBX-5/6-15W-5CCT-WH-SM	120V	15w	1125lm	50/40/35/30/27K



### External J-Box

- Canless model, no housing required
- Triac dimmable down to 5%

Box Qty. 24

Model	Voltage	Watts	Lumens	Color
LED-RDL-EXJBX-4-3P12-5CCT-WH-SM	120V	8/10/12w	See Chart	50/40/35/30/27K
LED-RDL-EXJBX-6-3P18-5CCT-WH-SM	120V	12/15/18w	See Chart	50/40/35/30/27K



WATT	LUMENS	WATT	LUMENS
8	560	12	700
10	700	15	1,100
12	960	18	1,500

### Retrofit Models

- Compatible with 4" or 6" housings
- Triac dimmable down to 5%
- Title 24 connector (E26 adapter included)

Box Qty. RDL-4- 60 RDL-5/6- 36

Model	Voltage	Watts	Lumens	Color
LED-RDL-4-PC-CCT-WH-SM	120V	12/10/8w	See Chart	50/40/35/30/27K
LED-RDL-5/6-PC-CCT-WH-SM	120V	12/15/18w	See Chart	50/40/35/30/27K



WATT	LUMENS	WATT	LUMENS
8	560	12	900
10	680	15	1,100
12	800	18	1,300

### Retrofit Models: Multi-Volt

- Compatible with 4" or 6" housings
- 0-10V dimmable down to 5%
- Title 24 connector (E26 adapter included)

Box Qty. RDL-4- 60 RDL-5/6- 36

Model	Voltage	Watts	Lumens	Color
LED-RDL-4-3P12-5CCT-UNV-0/10V	120-277V	12/10/8w	See Chart	50/40/35/30/27K
LED-RDL-5/6-3P18-5CCT-UNV-0/10V	120-277V	18w/14/10w	See Chart	50/40/35/30/27K



WATT	LUMENS	WATT	LUMENS
8	600	10	700
10	850	14	1,100
12	1,100	18	1,500

Pre-installed Accessory Model	Description
Add '-EMB' to model #	Emergency Backup (External 25W)
RDL-5/6CLIP	Tension clip for 5/6" Downlight. For use in old housings

## Round Retrofit Downlight Accessories

Accessory Model	Description
RDL-TRIM-4-BLK-SM	4" Black Trim Smooth
RDL-TRIM-4-BZ-SM	4" Bronze Trim Smooth
RDL-TRIM-4-BN-SM	4" Brushed Nickel Trim Smooth
RDL-TRIM-4-WH-BFL	4" White Trim Baffle
RDL-TRIM-4-BLK-BFL	4" Black Trim Baffle
RDL-TRIM-4-BZ-BFL	4" Bronze Trim Baffle
RDL-TRIM-4-BN-BFL	4" Brushed Nickel Trim Baffle
RDL-TRIM-4-CUSTOM	4" Custom Trim
RDL-TRIM-5/6-BLK-SM	5/6" Black Trim Smooth
RDL-TRIM-5/6-BZ-SM	5/6" Bronze Trim Smooth
RDL-TRIM-5/6-BN-SM	5/6" Brushed Nickel Trim Smooth
RDL-TRIM-5/6-WH-BFL	5/6" White Trim Baffle
RDL-TRIM-5/6-BLK-BFL	5/6" Black Trim Baffle
RDL-TRIM-5/6-BRZ-BFL	5/6" Bronze Trim Baffle
RDL-TRIM-5/6-BN-BFL	5/6" Brushed Nickel Trim Baffle
RDL-TRIM-5/6-CUSTOM	5/6" Custom Trim

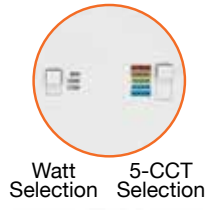

**DISPLAY**  
Display featuring 10 of our canless downlights. Place a \$3,000+ stock orders of downlights and get a free counter display.







## 6" Innovate Downlight

### Single CCT

**Box Qty:**  
**6**

Model	Voltage	Watts	Lumens	Color	CRI
LED-FL-RES-6-18W-CW-UNV	120-277V	18w	1500	4000k	>80

Accessory Model	Description
LED-EMB-25W-HV-0/10V	Emergency Back Up For Internal Drivers (Works with all 0-10V Dim or <25W fixtures) -Single Sided Flex-



## 4" 12V Innovate Downlight

- Easy-mount spring clips allow tool-less retrofit installation
- Heavy-duty die-cast aluminum heatsink
- Only ideal with magnetic transformers
- Dimmable with low voltage dimmers
- Uses standard MR16 connector

### 5-CCT Select

**Box Qty:**  
**24**

Model	Voltage	Watts	Lumens	Color
LED-EDL-4-10W-5CCT-WH-12V	12V	10w	600	50/40/35/30/27K

### 5-CCT Select

**Box Qty:**  
**24**

**NEW**

Model	Voltage	Watts	Lumens	Color
LED-EDL-SQ-4-10W-5CCT-WH-12V	12V	10w	600	50/40/35/30/27K



## Adjustable Retrofit Downlight

- Adjustable fixture allows 360° free rotation, and 60° pitch angle
- 5CCT Color Selectable (27/30/35/40/50K)
- Title 24 connector (E26 adapter included)

### 4" Models

**Box Qty:**  
**24**

Model	Voltage	Watts	Lumens	Color
LED-DL-ADJ-4-10W-5CCT-WH	120V	10w	750	50/40/35/30/27k
LED-DL-ADJ-4-10W-5CCT-BLK	120V	10w	750	50/40/35/30/27k

### 5/6" Models

**Box Qty:**  
**16**

Model	Voltage	Watts	Lumens	Color
LED-DL-ADJ-5/6-16.5W-5CCT-WH	120V	16.5w	1200	50/40/35/30/27k
LED-DL-ADJ-5/6-16.5W-5CCT-BLK	120V	16.5w	1200	50/40/35/30/27k

### 5/6" Models

**Box Qty:**  
**16**

Model	Voltage	Watts	Lumens	Color
LED-DL-ADJ-5/6-16.5W-WW	120V	16.5w	1200	3000k



C4



C6

## LED Cans (IC-Rated)

- Features Title 24 quick connect for LED trims
- 0/10V: Made to order, compatible with 0-10V fixtures

### Fire-Rated Models

 Box Qty.  
4

Model	Voltage	Description
C4-NC-ICAT-LED-FR	120-277V	4" Fire Rated IC Can (New Construction)
C6-NC-ICAT-LED-FR	120-277V	6" Fire Rated IC Can (New Construction)
<b>NEW</b> C4-NC-ICAT-LED-FR-0/10V	120-277V	4" Fire Rated IC Can (New Construction)
<b>NEW</b> C6-NC-ICAT-LED-FR-0/10V	120-277V	6" Fire Rated IC Can (New Construction)



C4-NC-ICAT-LED



C6-NC-ICAT-LED



C4-RM-ICAT-LED



C6-RM-ICAT-LED

### Regular Models

 Box Qty.  
6

Model	Voltage	Description
C4-NC-ICAT-LED	120-277V	4" IC Rated Can (New Construction)
C4-RM-ICAT-LED	120-277V	4" IC Rated Can (Remodel)
C6-NC-ICAT-LED	120-277V	6" IC Rated Can (New Construction)
C6-RM-ICAT-LED	120-277V	6" IC Rated Can (Remodel)
<b>NEW</b> C4-NC-ICAT-LED-0/10V	120-277V	4" IC Rated Can (New Construction)
<b>NEW</b> C4-RM-ICAT-LED-0/10V	120-277V	4" IC Rated Can (Remodel)
<b>NEW</b> C6-NC-ICAT-LED-0/10V	120-277V	6" IC Rated Can (New Construction)
<b>NEW</b> C6-RM-ICAT-LED-0/10V	120-277V	6" IC Rated Can (Remodel)

### 0-10V Connection

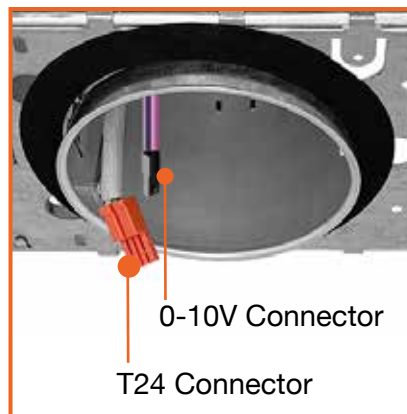

**Round Bi-Level Motion Sensor**  
Triac Dimmable



NEW	Model	Voltage	Watts	Lumens	Color
	LED-SLDSKR-5-12W-5CCT-WH-BMS	120-277V	12w	750	50/40/35/30/27K
	LED-SLDSKR-7-13W-5CCT-WH-BMS	120-277V	13w	1,050	50/40/35/30/27K
	LED-SLDSKR-12-23W-5CCT-WH-BMS	120-277V	23w	1950	50/40/35/30/27K

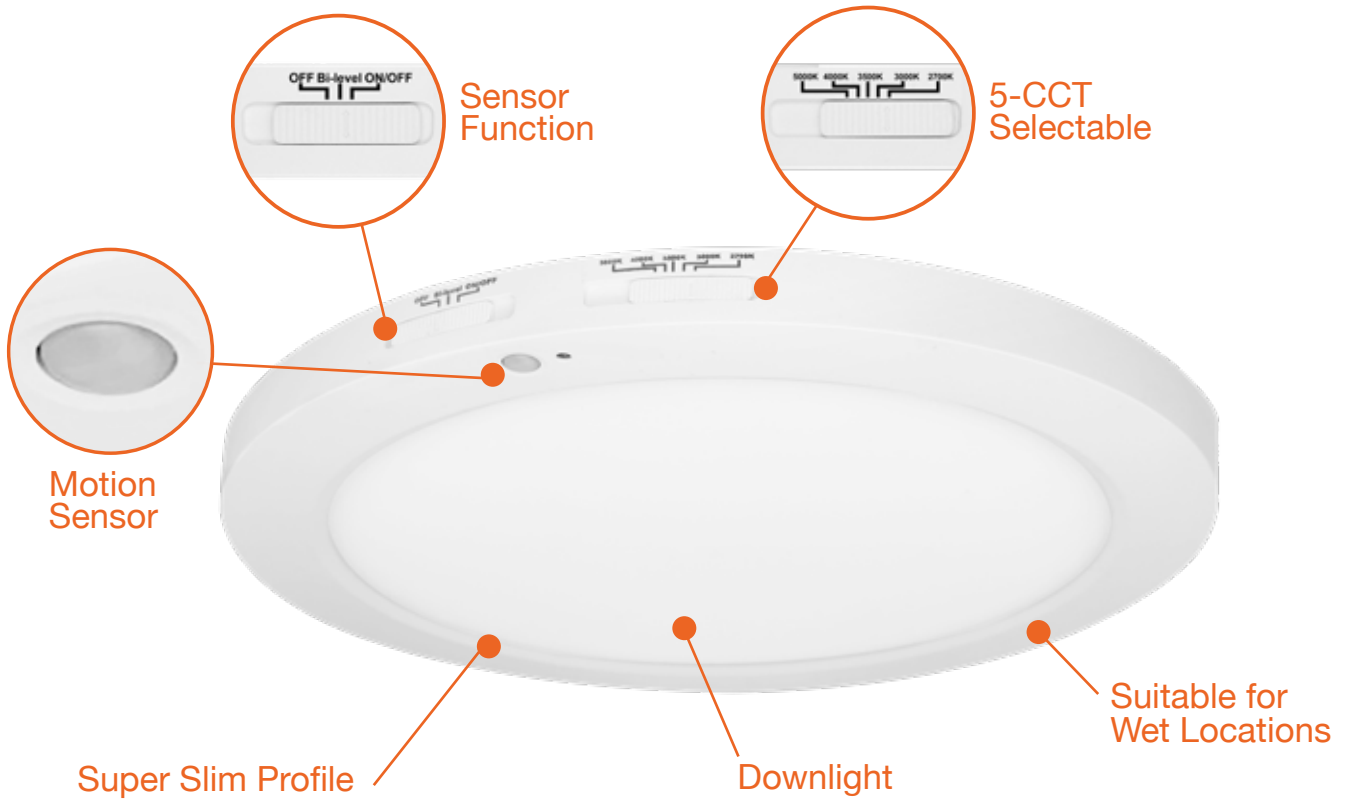

**CAN CONVERTER**  
(Included)

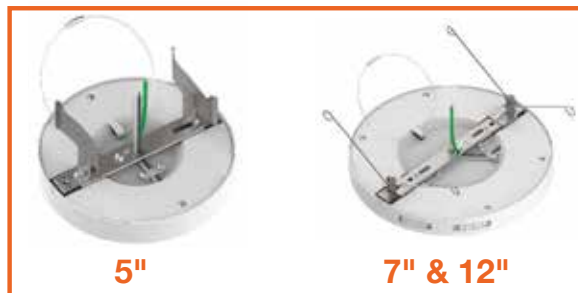

- Ultra thin, easy to install, and perfect for any kitchens, corridors
- Compatible with 30/40 junction box or recessed can installation
- Super thin modern frame



WH



BLK



BN



WH



BLK



BN



## 5" Trimless Surface Mounts

### 5-CCT Select

Model	Voltage	Watts	Lumens	Color
LED-TSM-5R-12W-5CCT-WH	120V	12w	850	50/40/35/30/27K



### Single CCT

Model	Voltage	Watts	Lumens	Color
LED-TSM-5R-12W-30K-BLK	120V	12w	850	3000k
LED-TSM-5R-12W-30K-BN	120V	12w	850	3000k

Box Qty. 20

Accessory Model	Description
TSM-4CLIP	4" Recessed Can Conv (for 5" only)

## 7" Trimless Surface Mounts

### 5-CCT Select

Box Qty. 12

Model	Voltage	Watts	Lumens	Color
LED-TSM-7R-15W-5CCT-WH	120V	15w	1100	50/40/35/30/27K



### Single CCT

Model	Voltage	Watts	Lumens	Color
LED-TSM-7R-15W-30K-BLK	120V	15w	1100	3000k
LED-TSM-7R-15W-30K-BN	120V	15w	1100	3000k

Box Qty. 12

### Emergency Backup

Box Qty. 20

Model	Voltage	Watts	Lumens
TSM-7R-EMB-UNV	120V	15w	1100
TSM-7R-EMB-UNV-EMPTY	-	-	-

Accessory Model	Description
TSM-6CLIP	6" Recessed Can Conv (for 7,9,11" only)

## 9" Trimless Surface Mounts

### 5-CCT Select

Box Qty. 12

Model	Voltage	Watts	Lumens	Color
LED-TSM-9R-18W-5CCT-WH	120V	18w	1300	50/40/35/30/27K



### Single CCT

Model	Voltage	Watts	Lumens	Color
LED-TSM-9R-18W-30K-WH	120V	18w	1300	3000k
LED-TSM-9R-18W-30K-BLK	120V	18w	1300	3000k
LED-TSM-9R-18W-30K-BN	120V	18w	1300	3000k

Box Qty. 12

### Emergency Backup

Box Qty. 10

Model	Voltage	Watts	Lumens
TSM-9R-EMB-UNV	120V	18w	1300
TSM-9R-EMB-UNV-EMPTY	-	-	-

Accessory Model	Description
TSM-6CLIP	6" Recessed Can Conv (for 7,9,11" only)

## 11" Trimless Surface Mounts

### 5-CCT Select

Box Qty. 12

Model	Voltage	Watts	Lumens	Color
LED-TSM-11R-20W-5CCT-WH	120V	20w	1500	50/40/35/30/27K



### Single CCT

Model	Voltage	Watts	Lumens	Color
LED-TSM-11R-20W-30K-WH	120V	20w	1500	3000k
LED-TSM-11R-20W-30K-BLK	120V	20w	1500	3000k
LED-TSM-11R-20W-30K-BN	120V	20w	1500	3000k

Box Qty. 12

Accessory Model	Description
TSM-6CLIP	6" Recessed Can Conv (for 7, 9, 11" only)

Accessory Model	Description
LED-EMB-25W-HV-0/10V	Emergency Back Up For Internal Drivers (Works with all 0-10V Dim or <25W fixtures) Single Sided Flex

## Round Slimline Surface Mounts

- Edge-lit design provides even light distribution
- Check spec sheet for dimmer compatibility. Triac and 0-10V options are available.
- Work in 30/40 J-Box (0/10V Version only 40)
- Fixture is wet location rated
- Newly updated CCT switch, allows for installation into pancake J-box

Box Qty.  
5- 20  
7- 20  
12- 6  
15- 5  
19- 4

### Triac Dimmable



WH



BLK



BN



**NEW**

**NEW**

**NEW**

Model	Voltage	Watts	Lumens	Color
LED-SLDSKR-5-10W-30K	120V	10w	650	3000k
LED-SLDSKR-5-10W-5CCT-WH	120V	10w	650	50/40/35/30/27K
LED-SLDSKR-7-15W-5CCT-WH	120V	15w	1000	50/40/35/30/27K
LED-SLDSKR-12-22W-5CCT-WH	120V	22w	1400	50/40/35/30/27K
LED-SLDSKR-12-24W-5CCT-WH	120V	24w	1800	50/40/35/30/27K
LED-SLDSKR-15-30W-5CCT-WH	120V	30w	2000	50/40/35/30/27K
LED-SLDSKR-15-30W-5CCT-BLK	120V	30w	2000	50/40/35/30/27K
LED-SLDSKR-15-30W-5CCT-BN	120V	30w	2000	50/40/35/30/27K
LED-SLDSKR-19-35W-TRI-WH	120V	35w	2200	50/40/30k
LED-SLDSKR-19-35W-5CCT-WH	120V	35w	2200	50/40/35/30/27K
LED-SLDSKR-19-35W-5CCT-BLK	120V	35w	2200	50/40/35/30/27K
LED-SLDSKR-19-35W-5CCT-BN	120V	35w	2200	50/40/35/30/27K
LED-SLDSKR-24-40W-5CCT-WH	120V	40w	2700	50/40/35/30/27K
LED-SLDSKR-24-40W-5CCT-BL	120V	40w	2700	50/40/35/30/27K



### 0-10V 120-277V

Box Qty.  
5- 20  
7- 20  
12- 6

Model	Voltage	Watts	Lumens	Color
LED-SLDSKR-5-10W-TRI-0/10V	120-277V	10w	650	50/40/30k
LED-SLDSKR-5-10W-5CCT-WH-0/10V	120-277V	10w	650	50/40/35/30/27K
LED-SLDSKR-7-15W-5CCT-WH-0/10V	120-277V	15w	1000	50/40/35/30/27K
LED-SLDSKR-12-22W-TRI-0/10V	120-277V	22w	1450	50/40/30k
LED-SLDSKR-12-22W-5CCT-0/10V	120-277V	22w	1450	50/40/35/30/27K
LED-SLDSKR-15-30W-5CCT-WH-0/10V	120-277V	30w	2000	50/40/35/30/27K



BN

BLK

BZ

### Slimline Disk Trims

Box Qty.  
20

Model	Description
SLDSKR-5-TRIM-BLK	5" Round Snap on Trim Black
SLDSKR-5-TRIM-BRZ	5" Round Snap on Trim Bronze
SLDSKR-5-TRIM-BNI	5" Round Snap on Trim Brushed Nickel
SLDSKR-7-TRIM-BLK	7" Round Snap on Trim Black
SLDSKR-7-TRIM-BRZ	7" Round Snap on Trim Bronze
SLDSKR-7-TRIM-BNI	7" Round Snap on Trim Brushed Nickel
SLDSKR-12-TRIM-BLK	12" Round Snap on Trim Black
SLDSKR-12-TRIM-BRZ	12" Round Snap on Trim Bronze
SLDSKR-12-TRIM-BNI	12" Round Snap on Trim Brushed Nickel

### Accessories for Slimline Surface Mounts

Box Qty.  
7- 20  
12- 6

Accessory Model	Description
SLDSKR-7-EMB-UNV	7" Round EM BACKUP for ALL Models
SLDSKR-7-EMB-EMPTY-UNV	7" Round BACKUP Empty Body for ALL Models
SLDSKR-12-EMB-UNV	12" Round EM BACKUP for ALL Models
SLDSKR-12-EMB-EMPTY-UNV	12" Round BACKUP Empty Body for ALL Models
SLDSK-4CLIP	Add the can converter on the fixture to install into a standard 4" recessed can.
SLDSK-7-6CLIP	Add the can converter on the fixture to install into a standard 7" recessed can.
SLDSK-12-6CLIP	Add the can converter on the fixture to install into a standard 7" recessed can.

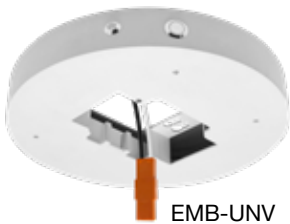

EMB-UNV

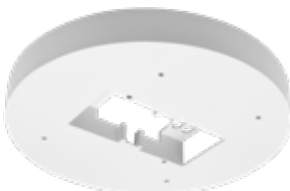

EMB-EMPTY-UNV

## 2' 4'/6' Pendant Stem Mount

Box Qty.  
6

**NEW**

Accessory Model	Description
STM-JBX-6-WH	Stem Pendant Mount for Surface Mount Fixtures
STM-JBX-6-BLK	Stem Pendant Mount for Surface Mount Fixtures

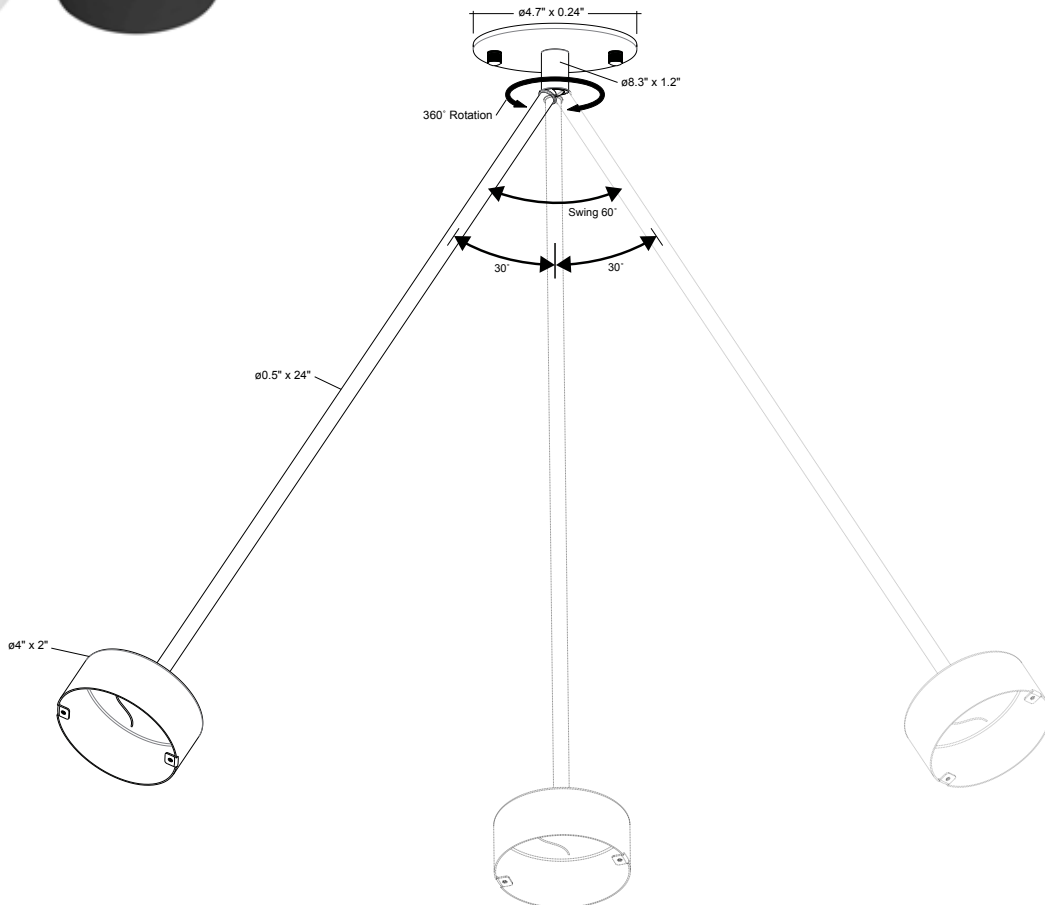





5"



7"



12"

## Square Slimline Surface Mounts

- Edge-lit design provides even light distribution
- Check spec sheet for dimmer compatibility. Triac and 0-10V options are available.
- Work in 30/40 J-Box (0/10V Version only 40)
- Fixture is wet location rated
- Newly updated CCT switch, allows for installation into pancake J-box

### Triac-Dimmable

Model	Voltage	Watts	Lumens	Color
LED-SLDSKSQ-5-10W-5CCT-WH	120V	10w	650	50/40/35/30/27K
LED-SLDSKSQ-5-10W-TRI	120V	10w	650	50/40/30k
LED-SLDSKSQ-7-15W-5CCT-WH	120V	15w	1000	50/40/35/30/27K
LED-SLDSKSQ-7-15W-TRI	120V	15w	1000	50/40/30k
LED-SLDSKSQ-12-22W-5CCT-WH	120V	22w	1450	50/40/35/30/27K

### 0-10V 120-277V

Box Qty. 20

Model	Voltage	Watts	Lumens	Color
LED-SLDSKSQ-5-10W-30K-WH-0/10V	120-277V	10w	650	3000k
LED-SLDSKSQ-5-10W-5CCT-WH-0/10V	120-277V	10w	650	50/40/35/30/27K
LED-SLDSKSQ-7-15W-5CCT-WH-0/10V	120-277V	15w	1000	50/40/30k
LED-SLDSKSQ-7-15W-TRI-0/10V	120-277V	15w	1000	50/40/30k

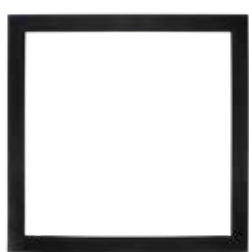

-BLK



-BNI



-BRZ

## Slimline Disk Trims

Model	Description
SLDSKSQ-5-TRIM-BLK	5" Square Snap on Trim Black
SLDSKSQ-5-TRIM-BRZ	5" Square Snap on Trim Bronze
SLDSKSQ-5-TRIM-BNI	5" Square Snap on Trim Brushed Nickel
SLDSKSQ-7-TRIM-BLK	7" Square Snap on Trim Black
SLDSKSQ-7-TRIM-BRZ	7" Square Snap on Trim Bronze
SLDSKSQ-7-TRIM-BNI	7" Square Snap on Trim Brushed Nickel
SLDSKSQ-12-TRIM-BLK	12" Square Snap on Trim Black
SLDSKSQ-12-TRIM-BRZ	12" Square Snap on Trim Bronze
SLDSKSQ-12-TRIM-BNI	12" Square Snap on Trim Brushed Nickel

Accessory Model	Description
SLDSK-4CLIP	Add the can converter on the fixture to install into a standard 4" recessed can.
SLDSK-7-6CLIP	Add the can converter on the fixture to install into a standard 6" recessed can.
SLDSK-12-6CLIP	Add the can converter on the fixture to install into a standard 6" recessed can.



## 4" Cusp Disk

- '-TRI' model switches between 3000k, 4000k, & 5000k
- Mount to existing 30 or 40 j-box or ceiling
- Fixture is damp rated. Silicone sealant required for wet location
- Newly updated CCT switch, allows for installation into pancake J-box

### 5-CCT Select

← DIMMABLE →  
 Box Qty. 20

Model	Voltage	Watts	Lumens	Color
LED-CDSK-4-10W-5CCT-WH	120V	10w	650	50/40/35/30/27K
LED-CDSK-4-10W-5CCT-BZ	120V	10w	650	50/40/35/30/27K



### 3-CCT Select

Box Qty. 20

Model	Voltage	Watts	Lumens	Color
LED-CDSK-4-10W-TRI-BN	120V	10w	650	50/40/30k

Accessory Model	Description
CDSK-4-CLIP	4" Recessed Can Converteror <25W fixtures -Single Sided Flex



## 6" Cusp Disk

### 5-CCT Select

Box Qty. 20

Model	Voltage	Watts	Lumens	Color
LED-CDSK-6-15W-5CCT-WH	120V	15w	1000	50/40/35/30/27K
LED-CDSK-6-15W-5CCT-BZ	120V	15w	1000	50/40/35/30/27K
LED-CDSK-6-15W-5CCT-BLK	120V	15w	1000	50/40/35/30/27K

### 3-CCT Select

Box Qty. 20

Model	Voltage	Watts	Lumens	Color
LED-CDSK-6-15W-TRI-BN	120V	15w	1000	50/40/30k

Accessory Model	Description
CDSK-6-CLIP	6" Recessed Can Converteror <25W fixtures -Single Sided Flex



## 6" Cusp Disk

### Single CCT

Box Qty. 20

Model	Voltage	Watts	Lumens	Color
LED-CDSK-6-15W-30K	120V	15w	1000	3000k
LED-CDSK-6-15W-40K	120V	15w	1000	4000k

Accessory Model	Description
CDSK-6-CLIP	6" Recessed Can Converteror <25W fixtures -Single Sided Flex



## 8" Cusp Disk

### CCT Select

Box Qty. 20

Model	Voltage	Watts	Lumens	Color
LED-CDSK-8-27W-5CCT-WH	120V	27w	2100	50/40/35/30/27K





### 4" Cusp Disk w/ PIR Sensor

- Motion sensor turns OFF after one minute
- Mount to existing 30 or 40 j-box or ceiling
- Fixture is damp rated. Silicone sealant required for wet location
- This item is not dimmable
- Newly updated CCT switch, allows for installation into pancake J-box
- Closet rated

#### 5-CCT Select



Model	Voltage	Watts	Lumens	Color
LED-CDSK-4-10W-5CCT-WH-PIR	120V	10w	650	50/40/35/30/27K

#### 3-CCT Select



Model	Voltage	Watts	Lumens	Color
LED-CDSK-4-10W-TRI-WH-PIR	120V	10w	650	50/40/30k

Accessory Model	Description
CDSK-4-CLIP	4" Recessed Can Converter



### 6" Cusp Disk w/ PIR Sensor

#### 5-CCT Select



Model	Voltage	Watts	Lumens	Color
LED-CDSK-6-15W-5CCT-WH-PIR	120V	15w	1000	50/40/35/30/27K



### Cylinder Downlight: Snaptrim Model

- Rotation 350° (horizontal) adjustable to 90° (vertical)
- Canless module does not require housing

#### 5-CCT Select



Model	Voltage	Watts	Lumens	Color
LED-DLJBX-3-CYL-ADJ-5CCT-WH	120V	15w	1000	50/40/35/30/27K
LED-DLJBX-3-CYL-ADJ-5CCT-BL	120V	15w	1000	50/40/35/30/27K



Up to 90° Angle





## Track Lights

- Rotation 350° (horizontal) adjustable to 90° (vertical)
- Interchangeable beam angle options
- Compatible with 3-wire single circuit track systems (H-Type)
- COB chip and PMMA lens

Box Qty. 30D- 24 36D- 12

### 5-CCT Select

Model	Voltage	Watts	Lumens	Color
LED-ATH-10W-5CCT-30D-WH	120V	10w	1000	50/40/35/30/27K
LED-ATH-10W-5CCT-30D-BLK	120V	10w	1000	50/40/35/30/27K
LED-ATH-20W-5CCT-36D-WH	120V	20w	2000	50/40/35/30/27K
LED-ATH-20W-5CCT-36D-BLK	120V	20w	2000	50/40/35/30/27K
LED-ATH-30W-5CCT-36D-WH	120V	30w	3000	50/40/35/30/27K
LED-ATH-30W-5CCT-36D-BLK	120V	30w	3000	50/40/35/30/27K

## Track Heads

Box Qty. 12

Model	Description
ATH-10W-24D	Track Heads: ACRY-Line 24D Optic
ATH-10W-60D	Track Heads: ACRY-Line 60D Optic
ATH-20W-24D	Track Heads: ACRY-Line 24D Optic
ATH-20W-60D	Track Heads: ACRY-Line 60D Optic
ATH-30W-24D	Track Heads: ACRY-Line 24D Optic
ATH-30W-60D	Track Heads: ACRY-Line 60D Optic

## Single Circuit 3-Wire Track

NEW

Model	Description
TS3-2FT-SM-WH	2' Track Single Circuit 3-Wire
TS3-2FT-SM-BL	2' Track Single Circuit 3-Wire
TS3-4FT-SM-WH	4' Track Single Circuit 3-Wire
TS3-4FT-SM-BL	4' Track Single Circuit 3-Wire
TS3-8FT-SM-WH	8' Track Single Circuit 3-Wire
TS3-8FT-SM-BL	8' Track Single Circuit 3-Wire

## Track Accessories

NEW

Model	Description
TS3-SM-LIVE-WH	Live End: Required to start a run
TS3-SM-LIVE-BL	Live End: Required to start a run
TS3-SM-END-WH	End Cap: Required to end a run
TS3-SM-END-BL	End Cap: Required to end a run
TS3-SM-MJ-WH	Mini Joiner: Low profile joiner for two straight track sections
TS3-SM-MJ-BL	Mini Joiner: Low profile joiner for two straight track sections
TS3-SM-SC-WH	Straight Connector: Connect two track sections end to end with a center
TS3-SM-SC-BL	Straight Connector: Connect two track sections end to end with a center
TS3-SM-L-WH	L-Connector: Connect two track sections at a right angle
TS3-SM-L-BL	L-Connector: Connect two track sections at a right angle
TS3-SM-T-WH	T-Connector: Connect two track sections at a T angle
TS3-SM-T-BL	T-Connector: Connect two track sections at a T angle
TS3-SM-X-WH	X-Connector: Connect two track sections at an cross angle
TS3-SM-X-BL	X-Connector: Connect two track sections at an cross angle
TS3-SM-FLX-WH	Flexible Connector: Connect two track sections at any angle up to 90°
TS3-SM-FLX-BL	Flexible Connector: Connect two track sections at any angle up to 90°
TS3-SM-PDM-WH	Pendant Adaptor: Provides electrical connection to wire in a pendant up to 25 lbs.
TS3-SM-PDM-BL	Pendant Adaptor: Provides electrical connection to wire in a pendant up to 25 lbs.
TS3-SM-FC-WH	Floating Canopy: Track can be connected to existing outlet box along the track.
TS3-SM-FC-BL	Floating Canopy: Track can be connected to existing outlet box along the track.



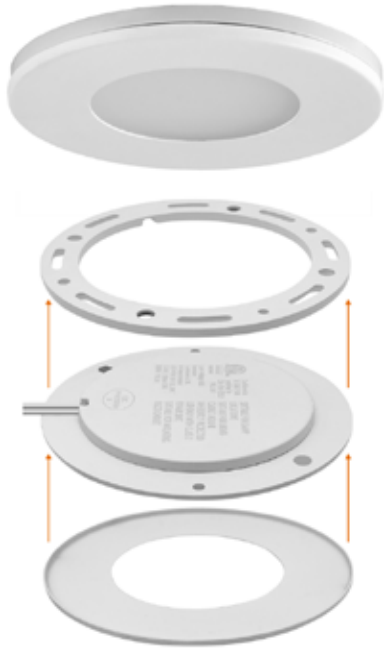

### Undercabinet Puck Light

- Mounting options include either recessed or surface mounted
- Embedded magnets allow for easily interchangeable face plate
- Split-wire connectors allow easy daisy-chaining of fixtures
- Dimmable with electronic constant voltage transformer. Do not use magnetic system.
- 5-100% dimming with compatible electronic dimming drivers (See CV Drivers)

### Single CCT



Model	Voltage	Watts	Lumens	Color
LED-PCK-3W-27K-12V	12V	3w	300	2700k
LED-PCK-3W-30K-12V	12V	3w	300	3000k
LED-PCK-3W-40K-12V	12V	3w	300	4000k
LED-PCK-3W-50K-12V	12V	3w	300	5000k
LED-PCK-3W-27K-24V	24V	3w	300	2700k
LED-PCK-3W-30K-24V	24V	3w	300	3000k

### Undercabinet Puck Light Accessories

Box Qty. 10



Model	Description
LED-PCK-TRIM-BRZ	Undercabinet Puck Trim (Bronze)
LED-PCK-TRIM-BLK	Undercabinet Puck Trim (Black)
LED-PCK-TRIM-SL	Undercabinet Puck Trim (Silver)
LED-PCK-TRIM-BNI	Undercabinet Puck Trim (Nickel)
LED-PCK-TRIM-CP	Undercabinet Puck Trim (Copper)
ET-12V-12W	12W Undercabinet Transformer

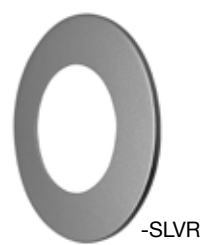



## End Connectors

Daisy chain multiple fixtures

## Edge-Lit Technology

Produces uniform, diffuse light

## Hardware Knockouts

No external wiring necessary

- Toggles between selectable colors, as well as high & low light intensity modes
- Frosted lens will not yellow or deform over time
- Use jumper connectors to daisy-chain multiple fixtures
- Compatible with most dimmers (e.g. Lutron DVCL-153P)
- Install as a hardwire or use included power cord
- Built-in screws in the front make installation easy

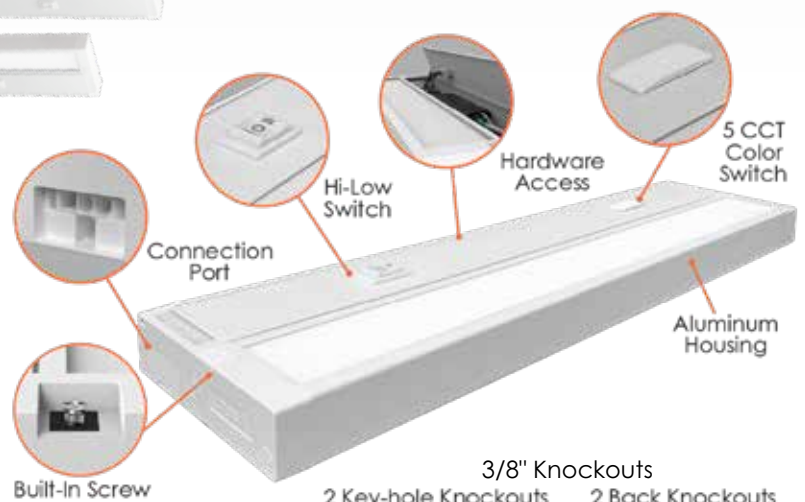

3/8" Knockouts  
2 Key-hole Knockouts    2 Back Knockouts

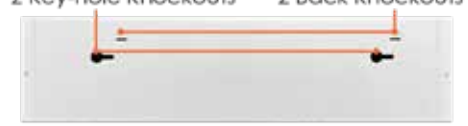

2 Side Knockouts



DISPLAY

## Undercabinet Bar Light 5-CCT Select Triac Dimmable

90 HIGH CRI  
JA8 TITLE 24 COMPLIANT  
Box Qty. 8, 11, 14- 12, 22, 28, 33, 42- 6

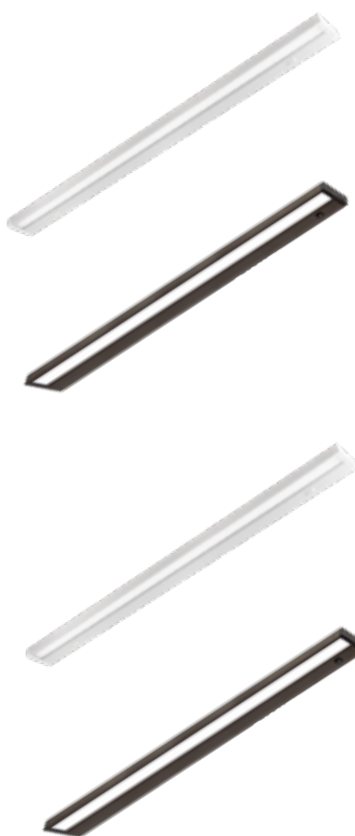

Model	Voltage	Watts	Lumens	Color
LED-UC-8I-4W-5CCT-WH	120V	4w	180	50/40/35/30/27K
LED-UC-11I-6W-5CCT-WH	120V	6w	350	50/40/35/30/27K
LED-UC-14I-8W-5CCT-WH	120V	8w	570	50/40/35/30/27K
LED-UC-22I-10W-5CCT-WH	120V	10w	750	50/40/35/30/27K
LED-UC-28I-12W-5CCT-WH	120V	12w	900	50/40/35/30/27K
LED-UC-33I-15W-5CCT-WH	120V	15w	1,050	50/40/35/30/27K
LED-UC-42I-18W-5CCT-WH	120V	18w	1,250	50/40/35/30/27K
LED-UC-8I-4W-5CCT-BZ	120V	4w	180	50/40/35/30/27K
LED-UC-11I-6W-5CCT-BZ	120V	6w	350	50/40/35/30/27K
LED-UC-14I-8W-5CCT-BZ	120V	8w	570	50/40/35/30/27K
LED-UC-22I-10W-5CCT-BZ	120V	10w	750	50/40/35/30/27K
LED-UC-28I-12W-5CCT-BZ	120V	12w	900	50/40/35/30/27K
LED-UC-33I-15W-5CCT-BZ	120V	15w	1,050	50/40/35/30/27K
LED-UC-42I-18W-5CCT-BZ	120V	18w	1,250	50/40/35/30/27K



## 5-CCT Select w/ USB & USB-C Triac Dimmable

**NEW**

Model	Voltage	Watts	Lumens	Color
LED-UC-11I-6W-5CCT-USB-WH	120V	6w	350	50/40/35/30/27K
LED-UC-14I-8W-5CCT-USB-WH	120V	8w	570	50/40/35/30/27K
LED-UC-22I-10W-5CCT-USB-WH	120V	10w	750	50/40/35/30/27K
LED-UC-28I-12W-5CCT-USB-WH	120V	12w	900	50/40/35/30/27K
LED-UC-42I-18W-5CCT-USB-WH	120V	18w	1,250	50/40/35/30/27K



## 5-CCT Select w/ USB & USB-C 0-10V Dimmable

**NEW**

Model	Voltage	Watts	Lumens	Color
LED-UC-14I-8W-5CCT-USB-WH-UNV	120-277V	8w	570	50/40/35/30/27K
LED-UC-22I-10W-5CCT-USB-WH-UNV	120-277V	10w	750	50/40/35/30/27K
LED-UC-28I-12W-5CCT-USB-WH-UNV	120-277V	12w	900	50/40/35/30/27K
LED-UC-42I-18W-5CCT-USB-WH-UNV	120-277V	18w	1,250	50/40/35/30/27K



**Included in the box**

**Optional Accessories**

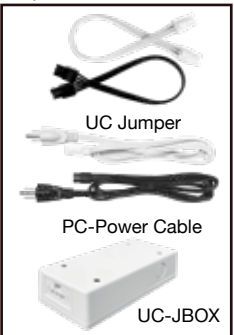
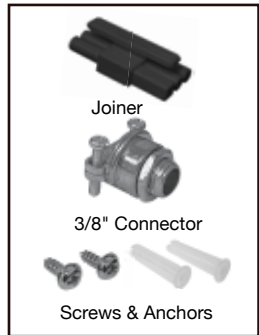

Accessory Model	Description
UC-JUMPER-6"-W	6" UC Jumper
UC-JUMPER-12"-W	12" UC Jumper
UC-JUMPER-24"-W	24" UC Jumper
UC-JUMPER-6"-B	6" UC Jumper
UC-JUMPER-12"-B	12" UC Jumper
UC-JUMPER-24"-B	24" UC Jumper
UC-5'-PC-WH	5' Power Cable
UC-5'-PC'-BZ	5' Power Cable
UC-JBOX	Undercabinet Junction Box

## C-Line: Undercabinet Fixtures (Economical Models) - Hardwire Only 5-CCT Select Triac Dimmable

90 HIGH CRI  
JA8 TITLE 24 COMPLIANT  
Box Qty. 11, 18- 24, 36, 42- 12



**NEW**

Model	Voltage	Watts	Lumens	Color
LED-EUC-11I-6W-5CCT-WH	120V	6w	450	50/40/35/30/27K
LED-EUC-18I-8W-5CCT-WH	120V	8w	600	50/40/35/30/27K
LED-EUC-24I-10W-5CCT-WH	120V	12w	900	50/40/35/30/27K
LED-EUC-36I-15W-5CCT-WH	120V	15w	1,125	50/40/35/30/27K
LED-EUC-42I-18W-5CCT-WH	120V	18w	1,350	50/40/35/30/27K





### LED Step Lights

- Available in white, bronze, or black finish
- 3 faceplates included in the box: horizontal angled louvre, vertical angled louvre, and flat frosted lens
- Rated for indoor and outdoor use (IP67)
- Non-dimmable

90 HIGH CRI Box Qty. 24

Model	Voltage	Watts	Lumens	Color
LED-STEP-AGL-2W-27K-120V-WH	120V	2w	150	2700k
LED-STEP-AGL-2W-27K-120V-BLK	120V	2w	150	2700k
LED-STEP-AGL-2W-27K-120V-BZ	120V	2w	150	2700k
LED-STEP-AGL-2W-30K-120V-WH	120V	2w	150	3000k
LED-STEP-AGL-2W-30K-120V-BLK	120V	2w	150	3000k
LED-STEP-AGL-2W-30K-120V-BZ	120V	2w	150	3000k
LED-STEP-AGL-2W-40K-120V-WH	120V	2w	150	4000k
LED-STEP-AGL-2W-40K-120V-BLK	120V	2w	150	4000k
LED-STEP-AGL-2W-40K-120V-BZ	120V	2w	150	4000k



### LED ARCY Step Lights

- Available in white, brushed nickel and black
- Vertical (VT) or Horizontal (HZ) versions available
- Rated for indoor and outdoor use (IP67)
- Non-dimmable

90 HIGH CRI Box Qty. 18

#### 5-CCT Select

Model	Voltage	Watts	Lumens	Color
LED-STEP-ARC-3W-5CCT-HZ-WH	120V	3w	150	50/40/35/30/27k
LED-STEP-ARC-3W-5CCT-VT-WH	120V	3w	150	50/40/35/30/27k
LED-STEP-ARC-3W-5CCT-HZ-BLK	120V	3w	150	50/40/35/30/27k
LED-STEP-ARC-3W-5CCT-VT-BLK	120V	3w	150	50/40/35/30/27k
LED-STEP-ARC-3W-5CCT-HZ-BN	120V	3w	150	50/40/35/30/27k
LED-STEP-ARC-3W-5CCT-VT-BN	120V	3w	150	50/40/35/30/27k







### Emergency Exit Sign (Single/Double Sided)

- Film protectant for extra shatter protection (food industry OK)
- Non-Dimmable
- For indoor use only

Box Qty. 12

Model	Voltage	Watts	Color
LED-EM-EXT-R-WH	120-277V	3w	Red
LED-EM-EXT-G-WH	120-277V	3w	Green



### Emergency Exit Sign (Single/Double Sided)

- Film protectant for extra shatter protection (food industry OK)
- Non-Dimmable
- For indoor use only
- Red and green selectable

Box Qty. 12

**NEW**

Model	Voltage	Watts	Color
LED-EM-EXT-RG-WH	120-277V	3w	Red/Green Selectable
LED-EM-EXT-RG-BL	120-277V	3w	Red/Green Selectable



### Emergency Exit Sign Combo (Single/Double Sided)

- Test switch and charge indicator
- Non-Dimmable
- Film protectant for extra shatter protection (food industry OK)
- For indoor use only

Box Qty. 10

Model	Voltage	Watts	Lumens	Color
LED-EM-EXT-R-WH-CMB	120-277V	3.5w	140	Red
LED-EM-EXT-G-WH-CMB	120-277V	3.5w	140	Green



### Emergency Exit Sign Combo (Single/Double Sided)

- Test switch and charge indicator
- Non-Dimmable
- Film protectant for extra shatter protection (food industry OK)
- For indoor use only
- Red and green selectable

Box Qty. 10

**NEW**

Model	Voltage	Watts	Lumens	Color
LED-EM-EXT-RG-WH-CMB	120-277V	3.5w	140	Red/Green Selectable
LED-EM-EXT-RG-BL-CMB	120-277V	3.5w	140	Red/Green Selectable



### Edge-Lit Emergency Exit Sign (Single/Double Sided)

- Can be illuminated single or double sided (Removeable plate in middle)
- Test switch and charge indicator
- Film protectant for extra shatter protection (food industry OK)
- For indoor use only

Box Qty. 10

Model	Voltage	Watts	Color
LED-EM-EXT-EL-R (S)	120-277V	3w	Red
LED-EM-EXT-EL-G (S)	120-277V	3w	Green
LED-EM-EXT-EL-R (D)	120-277V	3w	Red
LED-EM-EXT-EL-G (D)	120-277V	3w	Green



### Emergency Exit Sign (Single/Double Sided)

- Film protectant for extra shatter protection (food industry OK)
- Non-Dimmable
- For indoor use only
- Remote capable

Box Qty. 8

Model	Voltage	Watts	Lumens	Color
LED-EM-EXT-R-WH-CMB-RC	120-277V	3.5w	140	Red
LED-EM-EXT-G-WH-CMB-RC	120-277V	3.5w	140	Green



### Emergency Exit Sign (Single/Double Sided)

- Film protectant for extra shatter protection (food industry OK)
- Non-Dimmable
- For indoor use only
- Remote capable
- Red and green selectable

Box Qty. 8

**NEW**

Model	Voltage	Watts	Lumens	Color
LED-EM-EXT-RG-WH-CMB-RC	120-277V	3.5w	140	Red/Green



### Single Remote Head

- Film protectant for extra shatter protection (food industry OK)
- Non-Dimmable
- For indoor and outdoor use
- Only compatible with RC-EMB

Box Qty. 20

Model	Voltage	Watts	Lumens	Color
LED-EM-RC-1	120-277V	1.5w	160	5000K
LED-EM-RC-2	120-277V	3w	320	5000K



### Emergency LED Light

- Film protectant for extra shatter protection (food industry OK)
- Non-Dimmable
- For indoor use only

Box Qty. 12

Model	Voltage	Watts	Lumens	Color	CRI
LED-EM-DH	120-277V	3w	N/A	5000k	N/A



### Emergency LED Light

- Film protectant for extra shatter protection (food industry OK)
- Non-Dimmable
- For indoor use only

Box Qty. 12

**NEW**

Model	Voltage	Watts	Lumens	Color	CRI
LED-EM-DHC-WH	120-277V	3w	N/A	5000k	N/A
LED-EM-DHC-BL	120-277V	3w	N/A	5000k	N/A



### Slim Wall Pack: EGG-Line

- Die-cast aluminum housing
- Polycarbonate lens and mirror reflector
- Lithium battery 4.8V 1800mAh
- Backup time up to 90 min.
- EMB- Emergency Back-up
- Emergency mode- 690 Lumens

3-CCT Select

Box Qty. 10

Model	Voltage	Watts	Lumens	Color
LED-WPE-15W-TRI-PC-BZ	120-277V	15w	1950	50/40/30k
LED-WPE-15W-TRI-PC-BZ-EMB	120-277V	15w	1950	50/40/30k

\*Custom finishes include white, black, gray, and custom. 7 Day lead time required. Please contact us for pricing based on qty. for custom finish orders.



## Corn Bulbs - 3 Color and 3 Power Selectable

- Select between 3 different wattages and 3 different colors
- Includes 4K surge protection
- Multiple base types available
- Twist-C technology

Box Qty.  
3M36- 12  
3M54- 12  
3M80- 6  
3M120- 6



### 3-CCT & 3-Power Select

Model	Voltage	Watts	Lumens	Color
LED-CRN-3M36-TRI-E26	120-277V	18/27/36w	145lm/w	50/40/30k
LED-CRN-3M36-TRI-EX39	120-277V	18/27/36w	145lm/w	50/40/30k
LED-CRN-3M54-TRI-E26	120-277V	36/45/54w	145lm/w	50/40/30k
LED-CRN-3M54-TRI-EX39	120-277V	36/45/54w	145lm/w	50/40/30k
LED-CRN-3M80-TRI-EX39	120-277V	54/63/80w	145lm/w	50/40/30k
LED-CRN-3M120-TRI-EX39	120-277V	80/100/120w	145lm/w	50/40/30k



Accessory Model	Description
HB01DMS-A	Bi-Level Motion + Daylight Sensor
HB03R	Controller for HB01DMS-A (Controls Multiple)

WATT	LUMENS
18	2,610
27	3,915
36	5,220
45	6,525
54	7,830
63	9,135
80	11,600
100	14,500
120	17,400

3-CCT Selectable



3 Power Selectable



E26 Base



EX39 Base



Optional Motion + Daylight Sensor



HB03R  
Controller for  
HB01DMS-A



HB01DMS-A  
Bi Level Motion Sensor and  
Daylight Harvesting Sensor



### GX23 PL Lamp Type A+B

- Compatible with existing ballast or direct AC wiring
- Easily upgrade fluorescent fixtures, no rewiring required
- Not dimmable

8 HIGH CRI  Box Qty. 50

Model	Voltage	Watts	Lumens	Color
LED-PL-GX23-6W-40K	120-277V	6w	600	4000k
LED-PL-GX23-6W-50K	120-277V	6w	600	5000k



### G24 PL Lamp Type A+B

- Easily upgrade fluorescent fixtures, no rewiring required
- Not dimmable
- Compatible with existing ballast or direct AC wiring

8 HIGH CRI  Box Qty. 50

Model	Voltage	Watts	Lumens	Color
LED-PL-G24-7W-40K 13W Equivalent	120-277V	7w	650	4000k
LED-PL-G24-7W-50K 13W Equivalent	120-277V	7w	650	5000k
LED-PL-G24-11W-30K 13W Equivalent	120-277V	11w	1,300	3000k
LED-PL-G24-11W-40K 13W Equivalent	120-277V	11w	1,300	4000k
LED-PL-G24-11W-50K 13W Equivalent	120-277V	11w	1,300	5000k

### 2G11 PL Lamp

- Compatible with existing ballast
- Easily upgrade fluorescent fixtures, no rewiring required
- Not dimmable

8 HIGH CRI  Box Qty. 50

Final Production

Model	Voltage	Watts	Lumens	Color
LED-PL-2G11-15W-30K	120V	15w	1600lm	3000k





### Filament LED Bulbs

- Compatible with most dimmers
- View spec sheets for JA8 Models

#### 3-CCT & 3-Power Select



Model	Voltage	Watts	Lumens	Color
LED-FLM-A19-HM-4W-18K	120V	4w	400	1800k



#### A19

Box Qty. 40

Model	Voltage	Watts	Lumens	Color
LED-FLM-A19-8.5W-30K-D	120V	8.5w	550	3000k
LED-FLM-A19-4W-30K-12V	12v	4w	550	3000k
LED-FLM-A19-10W-27K	120V	10w	1,000	2700k



#### Candelabra

Box Qty. 100

Model	Voltage	Watts	Lumens	Color
LED-FLM-E12T-4W-30K-12V	12v	4w	400	3000k
LED-FLM-E12T-4W-27K	120V	4w	400	2700k
LED-FLM-E12T-4W-30K	120V	4w	400	3000k
LED-FLM-E12T-4W-60K	120V	4w	400	6000k
LED-FLM-E12FL-4W-27K	120V	4w	400	2700k
LED-FLM-E12T-6W-27K	120V	6w	600	2700k
LED-FLM-E12T-6W-30K	120V	6w	600	3000k
LED-FLM-E12T-6W-40K	120V	6w	600	4000k



#### ST64 Edison

Box Qty. 40

Model	Voltage	Watts	Lumens	Color
LED-FLM-ST64-4W-18K	120V	4w	400	1800k
LED-FLM-ST64-4W-30K	120V	4w	400	3000k



#### Globes

Box Qty. 100

Model	Voltage	Watts	Lumens	Color
LED-FLM-G16.5C-4W-27K	120V	4w	400	2700k
LED-FLM-G16.5M-4W-27K	120V	4w	400	2700k
LED-FLM-G25-5W-27K	120V	4w	400	2700k



#### Tubular

Box Qty. 40

Model	Voltage	Watts	Lumens	Color
LED-FLM-T30-4W-18K	120V	4w	400	1800k
LED-FLM-T30-4W-30K	120V	4w	400	3000k
LED-FLM-T30-4W-50K	120V	4w	400	5000k





## 5-CCT LED Bulbs

- Triac-dimmable
- Direct replacement for halogen bulbs
- Must be purchased in inner carton quantities

### A Series

Box Qty. 100

Model	Voltage	Watts	Lumens	Color
LED-A19-9W-5CCT	120V	9w	800lm	50/40/35/30/27k
LED-A21-15W-5CCT	120V	15w	1600lm	50/40/35/30/27k



Carton Qty.	A-19	A-21
Inner Carton	10	10
Master Carton	100	100



### BR Series

Box Qty. 100

Model	Voltage	Watts	Lumens	Color
LED-BR20-6W-5CCT	120V	6w	450lm	50/40/35/30/27k
LED-BR30-8.5W-5CCT	120V	8.5w	650lm	50/40/35/30/27k
LED-BR40-13W-5CCT	120V	13w	1050lm	50/40/35/30/27k



Carton Qty.	BR-20	BR-30	BR-40
Inner Carton	10	6	6
Master Carton	100	48	48



### PAR Series

Box Qty. 100

Model	Voltage	Watts	Lumens	Color
LED-P20-7W-5CCT	120V	7w	450lm	50/40/35/30/27k
LED-P30-10W-5CCT	120V	10w	750lm	50/40/35/30/27k
LED-P38-13W-5CCT	120V	13w	1000lm	50/40/35/30/27k



Carton Qty.	BR-20	BR-30	BR-40
Inner Carton	10	6	6
Master Carton	100	48	48



### A19 6-Pack Screw-Base LED Non-Dimmable Bulb

- High intensity: ready to replace existing 60W halogen
- Suitable for use in existing fixtures
- Sold in a 6-pack



Model	Voltage	Watts	Lumens	Color
LED-A19-9W-30K-ND6	120V	9w	800	3000k



### A21 Screw-Base LED Bulb

- High intensity: ready to replace existing 100W halogen
- Suitable for use in existing fixtures
- Compatible with most dimmers



Model	Voltage	Watts	Lumens	Color
LED-A21-16W-30K-HD	120V	16w	1,600	3000k
LED-A21-16W-40K-HD	120V	16w	1,600	4000k
LED-A21-16W-50K-HD	120V	16w	1,600	5000k



### A19 GU24 Bulb

- High intensity: ready to replace existing 65W halogen
- Suitable for use in existing fixtures
- Compatible with most dimmers



Model	Voltage	Watts	Lumens	Color
LED-A19GU24-9W-WW	120V	9w	800	3000k



### PAR38 12K Jewelry Bulb

- Shine our new 12,000K bulb on diamonds to add an extra sparkle
- Very powerful COB Chip provides 3,000 lumens
- Universal voltage 120-277v for commercial applications



Model	Voltage	Watts	Lumens	Color
LED-PAR38-32W-12K-UNV	120/277V	32w	3,000	12000k



### Candelabra Bulbs

- E12 'candelabra' base
- '-ND' models are non-dimmable
- '-D' models are dimmable



Model	Voltage	Watts	Lumens	Color
LED-E12-5W-30K-D	120V	5w	280	3000k
LED-E12-3W-27K-ND	120V	3w	280	2700k



### MR Series Bulbs

- Ideal replacements for MR-base halogens
- Integrated aluminum heatsink



Model	Voltage	Watts	Lumens	Color
LED-MR11-3W-30K-2PK	12V	3w	280	3000k
LED-MR16-5W-27K-HD	12V	5w	350	2700k
LED-MR16-5W-30K-HD	12V	5w	350	3000k
LED-MR16-7W-27K-HD	12V	7w	500	2700k
LED-MR16-7W-30K-HD	12V	7w	500	3000k
LED-MR16-7W-40K-HD	12V	7w	500	4000k
LED-MR16-7W-50K-HD	12V	7w	500	5000k
LED-MR16-9W-D-DIM	12V	9w	500	6500k



### GU10 Bulbs

- Drop-in GU10 halogen replacement
- Compatible with most dimmers



Model	Voltage	Watts	Lumens	Color
LED-GU10-5.5W-30K-HD	120V	5.5w	450	3000k
LED-GU10-5.5W-50K-HD	120V	5.5w	450	5000k



## G9 Bulbs

- Drop-in G9 halogen replacement
- Compatible with most dimmers



Model	Voltage	Watts	Lumens	Color
LED-G9-5W-HL-30K	120V	5w	500	3000k
LED-G9-5W-HL-40K	120V	5w	500	4000k



## G9 Bulbs

- Drop-in G9 halogen replacement
- Compatible with most dimmers

NEW



Model	Voltage	Watts	Lumens	Color
LED-G9-4.5W-27K	120V	4.5w	450	2700k
LED-G9-4.5W-30K	120V	4.5w	450	3000k



Final Production

## Bayonet Base Bulbs

- Available in single and double contact (-SC & -DC)
- Drop-in 12V halogen replacement



Model	Voltage	Watts	Lumens	Color
LED-BNWP-3W-WW-SC	12V	3w	280	3000k
LED-BNWP-3W-CW-SC	12V	3w	280	4000k
LED-BNWP-3W-WW-DC	12V	3w	280	3000k



## Wedge-Base Bulbs

- Available in single and double contact (-SC & -DC)
- Drop-in 12V halogen replacement
- Compatible with most dimmers



Model	Voltage	Watts	Lumens	Color
LED-WGWP-3W-WW	12V AC/DC	3w	280	3000k



## Bi-Pin 12V Bulbs

- Pin-compatible drop-in replacement for 12V halogens
- Compatible with most dimmer modules
- Fully waterproof silicone enclosure



Model	Voltage	Watts	Lumens	Color
LED-G4WP-1.5W-SW	12V AC/DC	1.5w	110	2700k
LED-G4WP-1.5W-WW	12V AC/DC	1.5w	110	3000k
LED-G4WP-1.5W-CW	12V AC/DC	1.5w	110	4000k
LED-G4WP-2.5W-SW	12V AC/DC	2.5w	210	2700k
LED-G4WP-2.5W-WW	12V AC/DC	2.5w	210	3000k
LED-G4WP-2.5W-CW	12V AC/DC	2.5w	210	4000k
LED-G4WP-3.5W-SW	12V AC/DC	3.5w	280	2700k
LED-G4WP-3.5W-WW	12V AC/DC	3.5w	280	3000k
LED-G4WP-3.5W-CW	12V AC/DC	3.5w	280	4000k
LED-GY6.35-4W-27K	12V AC/DC	4w	350	2700k
LED-GY6.35-4W-30K	12V AC/DC	4w	350	3000k



## PAR LUX Series Bulb (40°)

- Ideal for landscape lighting (IP67)
- Compatible with most dimmers
- Integrated aluminum heatsink



Model	Voltage	Watts	Lumens	Color
LED-PAR36-13W-W	12V	13w	780	3000k





### 120V Architectural Striplights

- Lumen & watt ratings are per-foot
- Compatible with most dimmer modules
- Cutable every 18"
- Available in 100ft rolls



Model	Voltage	Watts	Lumens	Color
ST-2835-120V-4W-30K	120V	4w/ft	320/ft	3000k
ST-2835-120V-4W-40K	120V	4w/ft	320/ft	4000k
ST-2835-120V-4W-50K	120V	4w/ft	320/ft	5000k

### 120V Architectural Striplight Accessories

Box Qty.  
100



ST-POWSET-18  
ST-POWSET-36  
ST-POWSET-72



ST-JBX-POW-1200-36"  
ST-POW-UNV-400W-36"

Model	Voltage	Watts	Lumens	Color
ST-POWSET-18	120V	N/A	N/A	White
ST-POWSET-36	120V	N/A	N/A	White
ST-POWSET-72	120V	N/A	N/A	White
ST-JBX-POW-1200W-36"	120V	N/A	N/A	White
ST-POW-UNV-400W-36"	120V	N/A	N/A	White
ST-JUMPER-6	120V	N/A	N/A	White
ST-JUMPER-12	120V	N/A	N/A	White
ST-120-WP-COUP	120V	N/A	N/A	Clear
120V-STRAP-100PK	120V	N/A	N/A	N/A
ST-COUP-PIN-25PK	120V	N/A	N/A	N/A
ST-END-CAP-20PK	120V	N/A	N/A	N/A



ST-JUMPER-6  
ST-JUMPER-12



ST-120-WP-COUP



120V-STRAP-100PK



ST-COUP-PIN



ST-END-CAP



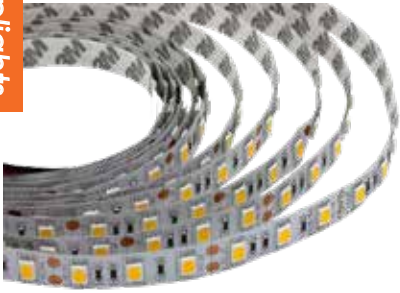

## Low Voltage Striplights (12V)

- Lumen & watt ratings are per-foot
- Mains-dimmable with magnetic transformer
- Available in 100ft rolls



Model	Voltage	Watts	Lumens	Color
LED-TP-3528-12V-DL	12V DC	1.5w/ft	120/ft	5000k
LED-TP-3528-12V-R	12V DC	1.5w/ft	120/ft	Red
LED-TP-3528-12V-B	12V DC	1.5w/ft	120/ft	Blue
LED-TP-3528-12V-G	12V DC	1.5w/ft	120/ft	Green
LED-TP-2835-12V-DL	12V DC	2.2w/ft	180/ft	5000k
LED-TP-5050-12V-DL	12V DC	4w/ft	285/ft	5000k

## Low Voltage Striplights (24V)



Model	Voltage	Watts	Lumens	Color
LED-TP-2216-2W-24V95-WW	24V DC	2w/ft	150/ft	3000k
LED-TP-2216-2W-24V95-DL	24V DC	2w/ft	150/ft	5000k
LED-TP-2216-3W-24V95-DL	24V DC	3w/ft	225/ft	5000k
LED-TP-2216-4W-24V95-DL	24V DC	4w/ft	300/ft	5000k





### Constant Voltage Triac Dimmable Transformers

Box Qty.  
20W- 12  
12V 60- 12  
12V 150- 6  
24V 60- 6

Model	Voltage	Watts
CV-12V-DC-20W-DIM	Input: 120-277V Output: 12V DC	20w
CV-12V-DC-60W-DIM	Input: 120-277V Output: 12V DC	60w
CV-12V-DC-150W-DIM	Input: 120-277V Output: 12V DC	150w
CV-24V-DC-60W-DIM	Input: 120-277V Output: 24V DC	60w

### Magnetic Transformers

- Suitable for use with EnVision 12V strip lights, puck lights, etc.
- Allows mains dimming for compatible 12V fixtures
- Rated for 120VAC input only

IP67 RATED Box Qty. 10



Model	Input Voltage	Output Voltage	Watts
MT-12V-DC-20W-DIM	120VAC	12V	20W
MT-12V-DC-40W-DIM	120VAC	12V	40W
MT-12V-DC-60W-DIM	120VAC	12V	60w
MT-12V-DC-100W-DIM	120VAC	12V	100w
MT-12V-DC-150W-DIM	120VAC	12V	150w
MT-12V-DC-200W-DIM	120VAC	12V	200w
MT-12V-DC-300W-DIM	120VAC	12V	300w
MT-24V-DC-20W-DIM	120VAC	24V	20W
MT-24V-DC-40W-DIM	120VAC	24V	40W
MT-24V-DC-60W-DIM	120VAC	24V	60w
MT-24V-DC-100W-DIM	120VAC	24V	100w
MT-24V-DC-150W-DIM	120VAC	24V	150w
MT-24V-DC-200W-DIM	120VAC	24V	200w
MT-24V-DC-300W-DIM	120VAC	24V	300w

### Electronic Magnetic Transformers

- Suitable for use with EnVision 24V strip lights, puck lights, etc.
- Allows mains dimming for compatible 24V fixtures
- Rated for 120VAC input only

IP67 RATED Box Qty. 12  
12V 30-80W: 12  
12V 120-300W: 6  
24V 30-80W: 12  
24V 120-300W: 6



Model	Input Voltage	Output Voltage	Watts
MLE-12V-DC-30W-DIM	120VAC	12V	30w
MLE-12V-DC-60W-DIM	120VAC	12V	60w
MLE-12V-DC-80W-DIM	120VAC	12V	80w
MLE-12V-DC-120W-DIM	120VAC	12V	120w
MLE-12V-DC-150W-DIM	120VAC	12V	150w
MLE-12V-DC-200W-DIM	120VAC	12V	200w
MLE-12V-DC-300W-DIM	120VAC	12V	300w
MLE-24V-DC-30W-DIM	120VAC	24V	30w
MLE-24V-DC-60W-DIM	120VAC	24V	60w
MLE-24V-DC-80W-DIM	120VAC	24V	80w
MLE-24V-DC-120W-DIM	120VAC	24V	120w
MLE-24V-DC-150W-DIM	120VAC	24V	150w
MLE-24V-DC-200W-DIM	120VAC	24V	200w
MLE-24V-DC-300W-DIM	120VAC	24V	300w



## Waterproof Junction Box Coupling

Box Qty.  
100

Model	Item Description
<b>NEW</b> JBX-WP-3P	Waterproof J-Box Coupling: 3-Wire
JBX-WP-4P	Waterproof J-Box Coupling: 4-Wire
JBX-WP-5P	Waterproof J-Box Coupling: 5-Wire
JBX-WP-6P	Waterproof J-Box Coupling: 6-Wire

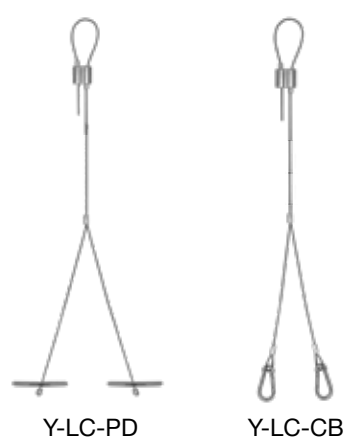

## Suspension Kits & Chain Kits

Model	Item Description
<b>NEW</b> SK-10FT-Y-LC-PD	Suspension Kit: 10' Y-Shape, Loop Top, Paddle Bottom (Adjustable Length)
<b>NEW</b> SK-20FT-Y-LC-PD	Suspension Kit: 20' Y-Shape, Loop Top, Paddle Bottom (Adjustable Length)
<b>NEW</b> SK-10FT-Y-LC-CB	Suspension Kit: 10' Y-Shape, Loop Top, Carabiner Bottom (Adjustable Length)
<b>NEW</b> SK-20FT-Y-LC-CB	Suspension Kit: 20' Y-Shape, Loop Top, Carabiner Bottom (Adjustable Length)
CK-6FT-V	6ft Chain Hanging Kit



CK-6FT-V



## Surge Protectors

Box Qty.  
10

Model	Input	Watt
<b>NEW</b> SG-20KV-UNV	120-277V	<1W
SG-20KV-HV	277-480V	<1W



## Button Photocell Universal

Box Qty.  
10

Model	Input	Output
PC-BTN-UNV-1/2"	120/277V	25-48v DC
PC-BTN-UNV-3/8"	120/277V	25-48v DC
PC-TWL-RC	120/277V	25-48v DC
PC-TWL-UNV	120/277V	25-48v DC
PC-TWL-HV	120/277V	25-48v DC



S-TWC-MW-1  
S-TWC-MW-BT  
TWC-DL



S-TWC-PIR-1



S-TWC-90



HB01DMS-A



HB01DMS-C



HB03R



HD406VRH-D-WH



HD407V-CR



HD03R



HD05R

## Twist-C Control Sensors

Box Qty. 1

Model	Item Description	Output Voltage	Watts
S-TWC-MW-1	Twist-C Microwave Sensor BRIGHTNESS: 100%/ HOLD TIME: 10MIN. BI-LEVEL DIM: 50% STAND BY TIME: 10 MIN SENSITIVITY: 100% DAYLIGHT: ENABLED"	12V	<1W
S-TWC-PIR-1	"Twist-C Microwave Sensor BRIGHTNESS: 100%/ HOLD TIME: 10MIN. BI-LEVEL DIM: 50% STAND BY TIME: 10 MIN SENSITIVITY: 100% DAYLIGHT: 10"	12V	<1W
S-TWC-MW-BT	"Twist-C Microwave Sensor w/ Bluetooth App Control and Group: BRIGHTNESS, HOLD TIME, BI-LEVEL DIM, STAND BY TIME, SENSITIVITY, DAYLIGHT: DISABLED"	12V	<1W
S-TWC-PIR-BT	"Twist-C PIR Sensor w/ Bluetooth App Control and Group: BRIGHTNESS, HOLD TIME, BI-LEVEL DIM, STAND BY TIME SENSITIVITY, DAYLIGHT: DISABLED"	12V	<1W
TWC-DL	Twist-C Daylight Sensor: Dusk to Dawn, works like photocell	12V	<1W
S-TWC-90	TWC Extension Arm 90Degree	12V	<1W

- Universal input voltage (100-277v AC, 50/60Hz)
- Selectable emergency power (3/5/8W)
- Constant output power (auto-sensing output)
- UL Listed for field installation

## S-Line Sensors

Box Qty. 1

Model	Item Description	Voltage	Watts
S-BMS-INT-1	S-Line: Bi Level Motion Sensor w/ Daylight Harvesting, Ideal for use with LED-CBT. 12V Aux REQD. (Remote Optional)	12V	<1w
S-BMS-INT-1-BT	S-Line: Bi Level Motion Sensor w/ Daylight Harvesting, Ideal for use w/ LED-CBT 12V Aux REQD. (Remote or ENVISION SMART APP)	12V	<1w
S-BMS-EXT-1	S-Line: Bi Level Motion Sensor w/ Daylight Harvesting, Ideal for use with LED WALLPACKS. 12V Aux REQD. (Remote Required)	12V	<1w
S-BMS-EXT-1-BT	S-Line: Bi Level Motion Sensor w/ Daylight Harvesting, Ideal for use with Wallpacks. 12V Aux REQD. (Remote Required)	12V	<1w
S-TWC-90	S-Line 90DG Receptacle Extender	12V	<1w
S-PP-BT	S-Line: Dimmable power pack. Dim any 0-10V fixture (Remote or ENVISION SMART APP)	12V	<1w
S-LINE-R	Remote for S-LINE Series Sensors	12V	<1w
S-LINE-DIM-BT	Dimmer for S-LINE Series Bluetooth Sensors	12V	<1w

## HB-Line Sensors

Box Qty. 1

Model	Item Description	Voltage	Watts
HB01DMS-A	Bi Level Motion Sensor w/ Daylight Harvesting, Works with ARL2, RHB, CRN Twist into female 12V sensor auxiliary, remote required	12V	<1w
HB01DMS-C	Bi Level Motion Sensor w/ Daylight Harvesting 1/2" Knockout - Includes Auxiliary	12V	<1w
HB03R	Remote for HB01 Series	12V	<1w

## H-Line Sensors

Box Qty. 1

Model	Item Description	Voltage	Watts
HD406VRH-D-WH	Bi Level Motion Sensor w/ Daylight Harvesting White Finish with Side 1/2" Knock Out -Remote Control Compatible-	120-277V	<1w
HD407V-CR	Bi Level Motion Sensor w/ Daylight Harvesting Detachable Version w/ external sensor -Remote Control Compatible	120-277V	<1w
HD016VCR-8	Bi Level Motion Sensor w/ Daylight Harvesting Internal Version w/ antenna -Remote Control Compatible-	120-277V	<1w
HD03R	Remote for H-Line Sensors	120-277V	<1w
HD05R	Remote for H-Line Sensors w/ Screen	120-277V	<1w



S-BMS-INT-1  
S-BMS-INT-1-BT



S-BMS-EXT-1  
S-BMS-EXT-1-BT



S-PP-BT



S-LINE-R



S-LINE-DIM-BT

## Smart Sensors

- Universal input voltage (100-277v AC, 50/60Hz)
- Selectable emergency power (3/5/8W)
- Constant output power (auto-sensing output)
- UL Listed for field installation

Box Qty. 1

Model	Item Description	Voltage	Watts
SMART-MOD-BT	Smart Bluetooth Module - Dim, Group, Controls, via Bluetooth(Connect to any 0-10V Dim Fixture)	120-277V	<1w
SMART-MOD-WF	Smart Wifi Module - Dim, Group, Controls, via Wifi (Connect to any Triac Dimmable Fixture)	120-277V	<1w
SMART-MOD-BT-GTW	Gateway: Add time control, smart home capability	120-277V	<1w





### Battery Backup (30W High Voltage)

- Universal input voltage (100-347v AC, 50/60Hz)
- Constant output power (auto-sensing output)
- UL Listed for field installation
- Battery protection: over/under voltage, over-temp., short circuit
- Backup runtime: 90 minutes
- For use with internal driver - Includes Round UFO Highbay EM Kit



Model	Input	Watt	Output
LED-EMB-30W-HV-UFO	120/347V	30W	175V DC
LED-EMB-30W-HV-UFO-BL	120/347V	30W	175V DC
LED-EMB-30W-HV-UFO-WH	120/347V	30W	175V DC
UFO-TEST-CTR	N/A	N/A	N/A



### Battery Backup (15W Low Voltage Double Flex)

- For use with external driver fixtures including: flat panels, troffers, high bays, wraps, etc.



Model	Input	Watt	Output
LED-EMB-15W-LV	120/277V	15W	25-48V DC



### Battery Backup (15W Low Voltage Single Flex)

- For use with external driver fixtures including: flat panels, troffers, high bays, wraps, etc.



Model	Input	Watt	Output
LED-EMB-15W-LV-S	120/277V	15W	25-48V DC

### Battery Backup (Split Design)

- Universal input voltage (100-277v AC, 50/60Hz)
- Constant output power (auto-sensing output)
- UL Listed for field installation
- Battery protection: over/under voltage, over-temp., short circuit
- Backup runtime: 90 minutes
- For use with external driver w/ internal housing space: wall packs, canopy, etc.



Model	Input	Watt	Output
LED-EMB-8W-HV-0/10V-2P	120/277V	8W	120-277V
LED-EMB-15W-HV-0/10V-2P	120/277V	15W	120-277V
LED-EMB-25W-HV-0/10V-2P	120/277V	25W	120-277V
<b>NEW</b> LED-EMB-40W-HV-0/10V	120/277V	25W	120-277V
LED-EMB-25W-HV-2P	120/277V	25W	120-277V



### Battery Backup (Split Design)

- Universal input voltage (100-277v AC, 50/60Hz)
- Constant output power (auto-sensing output)
- UL Listed for field installation
- Battery protection: over/under voltage, over-temp., short circuit
- Backup runtime: 90 minutes
- For use with external driver w/ internal housing space: wall packs, canopy, etc.



Model	Input	Watt	Output
LED-EMB-4W-LV-INT	120/277V	4W	25-48V DC
LED-EMB-8W-LV-INT	120/277V	8W	25-48V DC
LED-EMB-20W-LV-INT	120/277V	20W	25-48V DC



Displays



Retrofit Display  
DISPLAY-RDL



Back



Undercabinet Display  
DISPLAY-UC



Canless Downlight Display  
DISPLAY-DLJBX

# EnVisionLED™

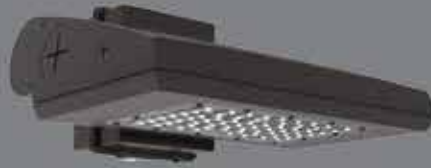

EnVision LED Lighting, Inc.  
Los Angeles, CA  
Phone: 323.604.0066

[www.envisionledlighting.com](http://www.envisionledlighting.com)



CATALOG-2024-V1