

Slim-Line: 4FT Linear High Bay
3-CCT + 5-Power Selectable



Detail Specifications

- Finish: White
- IP Rating: Damp Location
- Beam Angle: 110°
- Chip: SMD 2835, R9 >50, CRI >80
- Operating Temperature: -4° - 122° F
- Lens: Clear Prismatic Ribbed
 - Low Glare
- Average life (L70) of 70,000 hours

Applications:

- Warehouse/Distribution Facility
- Utility & Storage
- Garage Structures
- Commercial and Industrial

Product Information:

- Aluminum housing finished with corrosion free power coat
- Replace existing fixtures or use in new construction
- Easy maintenance: driver access from front
- Instant-On to full brightness
- Twist-C Control: Control ready receptacle built into each fixture
 - Standard Sensors
 - SILVAIR Bluetooth Mesh
 - ENVISIONLS Bluetooth
 - [Click Here](#) for More Information

Driver Options:

- UNV: 120-277V 0-10V Dimmable
- HV: 347-480V 0-10V Dimmable
- THD: <20% (+/-5% tolerance), PF >0.9, 50/60Hz

Mounting & Installation:

- 3.5' adjustable suspension kit included
- Optional 10 & 20' adjustable suspension kit available
- Optional 6' chain kit available
- Optional surface mount kit available
- Optional pendant mount kit available

Certifications:

- UL Listed for USA and CA
- DLC Premium Listed (High Bay Luminaires)
 - Product ID: S-546VDB
- ROHS Compliant
- Approved for CA T24
- 5 Year Limited Warranty
- FCC CFR 47, GCC Part 15, Subpart B:2017

| WATT | LUMENS |
|------|--------|
| 160 | 23,200 |
| 200 | 29,000 |
| 240 | 34,800 |
| 280 | 40,600 |
| 320 | 46,400 |

| Series | CCT | Voltage ¹ | Whip ² | Plug | Optic | EMB |
|--------------------------|--------------|--|---|---|---|--|
| LED-LHB-4FT-5P320 | CTRI | | | | | |
| 160/200/240/280/320W | 35/40 50K | UNV 120- 277V HV ¹ 347- 480V | (Blank) No Whip -6 6ft Whip 3-Wire -10 10ft Whip 3-Wire -20 20ft Whip 3-Wire -6F 6' Whip 5-Wire -10F 10' Whip 5-Wire -20F 20' Whip 5-Wire | (Blank) Hardwire SB 5-15P Straight Blade Plug TL L5-15P Twist Lock Plug | (Blank) 110° Standard 30D² 30° | (Blank) No Emergency Back-Up EMB25 25W 90 minute emergency backup EMB40 40W 90 minute emergency backup |

1. HV: High voltage is made to order.
2. 3-wire: for non-dimming or twist-c sensor applications. 5-wire: for 0-10v dimming applications. Emergency models will ship standard with extra emergency wire.

| Optional Accessories (Order Separately) | | | | | |
|---|---|--|---|---|---|
| Suspension Kits | Mounting Kits | Wire Guards | Whips (Field Install) | Sensors ¹ | Sensor Remote |
| SK-10FT-Y-LC-PD 10' Y-Shape, Loop Top, Paddle Bottom (Adjustable Length) | LHB-3P-PDM 165W, 220W, 320W Pendant Mount Kit | LHB-3P-4FT-WG 2ft 220 & 320W | 6'-WHIP-1/2KO 6' Whip 10'-WHIP-1/2KO 10' Whip Custom whips to size available 20'-WHIP-1/2KO 20' Whip Custom whips to size available | S-TWC-PIR-ON/OFF PIR Sensor On/Off Only 5/10/15min S-TWC-PIR-1 PIR Bi-Level Motion + Daylight Sensor (Remote Req'd) S-TWC-PIR-SL PIR SILVAIR Bluetooth Mesh + Daylight Sensor S-TWC-PIR-BT PIR ENVISIONLS Bluetooth Control | S-LINE-R Remote for S-Line Sensor SILVAIR Bluetooth mesh. Download on Apple or Android app store. ENVISIONLS Bluetooth smart app. Download on Apple or Android app store. |
| SK-20FT-Y-LC-PD 20' Y-Shape, Loop Top, Paddle Bottom (Adjustable Length) | LHB-3P-SM 165W, 220W, 320W Surface Mount Kit | | | | |
| SK-10FT-Y-LC-CB 10' Y-Shape, Loop Top, Carabiner Bottom (Adjustable Length) | | | | | |
| SK-20FT-Y-LC-CB 20' Y-Shape, Loop Top, Carabiner Bottom (Adjustable Length) | | | | | |
| CK-6FT-V 6' chain hanging kit | | | | | |

1. Sensor Note:
Microwave: Detects motion through barriers such as walls, and doors. Ideal for applications where obstacles might obstruct the line of sight. Works effectively outdoors, in large open spaces, & parking lots. Do not use in areas of high vibrations or metal.
PIR: Ideal for indoor environments with clear lines of sight to the area of interest. Detects warm objects, like a person or animal. Good for high vibration, areas of metal.

Specs and model numbers are subject to change with or without notice.

FEATURES

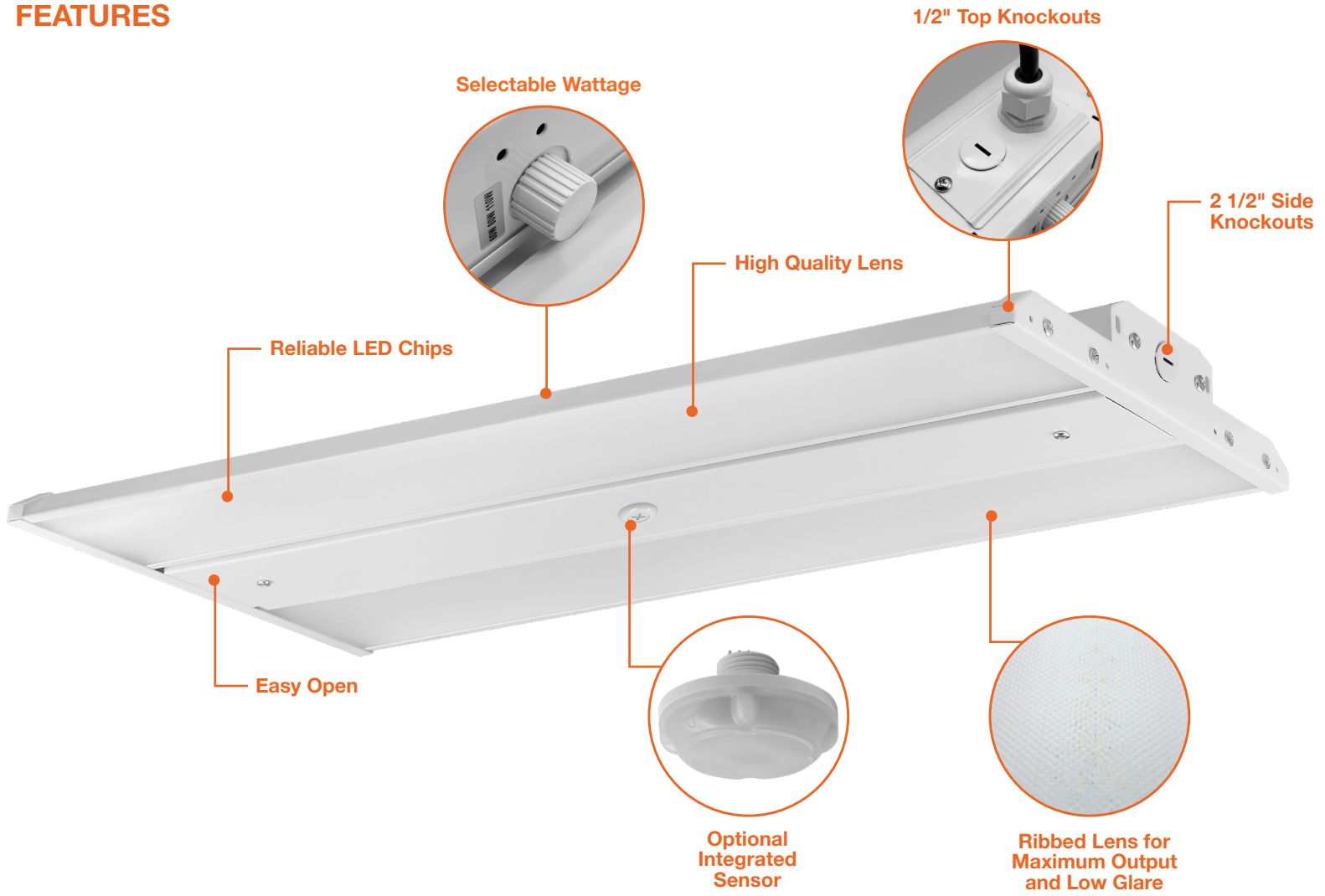

DIMENSIONS

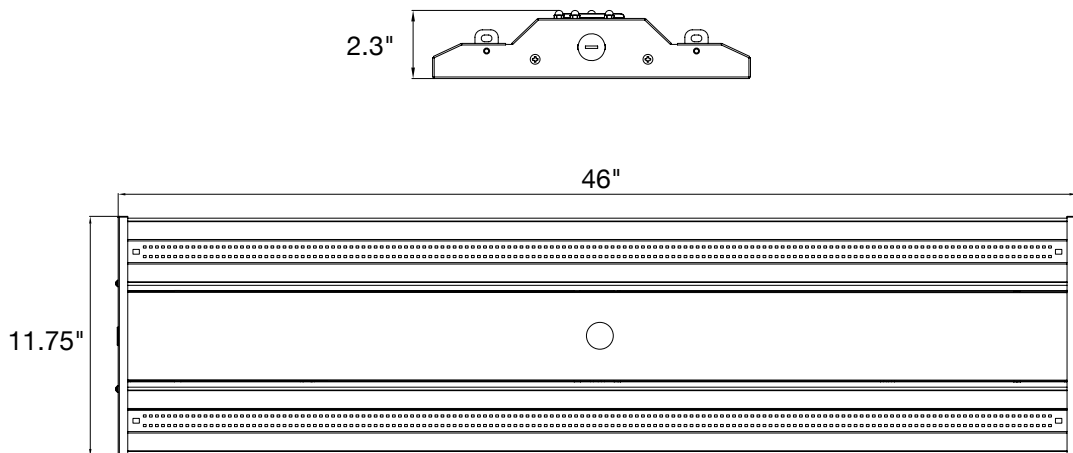

ACCESSORIES



SK-10FT-Y-LC-PD
SK-20FT-Y-LC-PD



SK-10FT-Y-LC-CB
SK-20FT-Y-LC-CB



CK-6FT-V

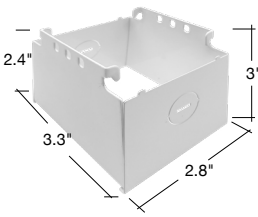

Pendant Mount 2ft
LHB-2FT-3P-PDM
Center Hole Size .85"

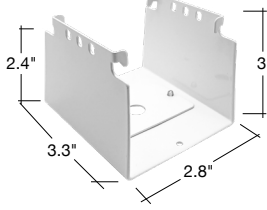

Surface Mount 2ft
(2 Pcs)
LHB-2FT-3P-SM
Center Hole Size 1"
Center Hole Size
w/ Plate .43"

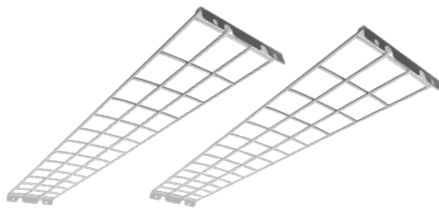

LHB-3P-4FT-WG

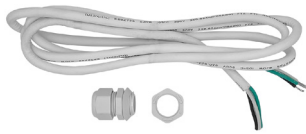

6'-WHIP-1/2KO
10'-WHIP-1/2KO
20'-WHIP-1/2KO



S-TWC-PIR
-ON/OFF



S-TWC-PIR-1
S-TWC-PIR-SL
S-TWC-PIR-BT



S-LINE-R
Controller



SB
5-15P Straight
Blade Plug



TL
L5-15P Twist
Lock Plug

HIGHBAY FIXTURE

| Model | Voltage | Watts | Lumens | Color |
|----------------------------|----------|----------------------|------------------------------------|-----------|
| LED-LHB-4FT-5P320-CTRI-UNV | 120-277V | 320/280/240/200/160w | 46,400/40,600/34,800/29,000/23,200 | 35/40/50k |

SUSPENSION KITS

| Accessory | Description |
|-----------------|---|
| SK-10FT-Y-LC-PD | 10' Y-Shape, Loop Top, Paddle Bottom (Adjustable Length) |
| SK-20FT-Y-LC-PD | 20' Y-Shape, Loop Top, Paddle Bottom (Adjustable Length) |
| SK-10FT-Y-LC-CB | 10' Y-Shape, Loop Top, Carabiner Bottom (Adjustable Length) |
| SK-20FT-Y-LC-CB | 20' Y-Shape, Loop Top, Carabiner Bottom (Adjustable Length) |
| CK-6FT-V | 6' Chain Hanging Kit |

MOUNTING KITS

| Accessory Model | Description |
|-----------------|---------------------------------------|
| LHB-3P-PDM | LHB: Pendant mount bracket up to 320W |
| LHB-3P-SM | LHB: Surface mount bracket up to 320W |

WIRE GUARDS

| Accessory Model | Description |
|-----------------|-------------------------------|
| LHB-3P-4FT-WG | Linear Highbay Wire Guard 4ft |

WHIPS (FIELD INSTALL)

| Accessory Model | Description |
|-----------------|-------------|
| 6'-WHIP-1/2KO | 6' Whip |
| 10'-WHIP-1/2KO | 10' Whip |
| 20'-WHIP-1/2KO | 20' Whip |

SENSORS

| Accessory Model | Description |
|------------------|--|
| S-TWC-PIR-ON/OFF | PIR Sensor On/Off Only 5/10/15min |
| S-TWC-PIR-1 | PIR Bi-Level Motion + Daylight Sensor (Remote Req'd) |
| S-TWC-PIR-SL | PIR SILVAIR Bluetooth Mesh + Daylight Sensor |
| S-TWC-PIR-BT | PIR ENVISIONLS Bluetooth Control |

SENSOR REMOTE









| Accessory Model | Description |
|-----------------|--|
| S-LINE-R | Remote for S-Line Sensor |
| SILVAIR | Bluetooth mesh. Download on Apple or Android app store. |
| ENVISIONLS | Bluetooth smart app. Download on Apple or Android app store. |

PLUG

| Accessory Model | Description |
|-----------------|---------------------------|
| SB | 5-15P Straight Blade Plug |
| TL | L5-15P Twist Lock Plug |

EnVisionLED™ Control Options

EnVision LED offers 3 control systems compatible with our LED Fixtures for projects of all sizes and budgets.

| | Basic Controls | EnVisionLS  | EnVisionLED™ X SILVAIR  |
|---|----------------------------------|---|--|
| Description | Standard Plug In Sensors | Basic Bluetooth Wireless Control | Advanced Bluetooth Wireless Control |
| Recommended Quantity (but not limited to) | N/A | >40-50 Nodes | >50 Nodes |
| Maximum Zone Quantity | N/A | 100 | 3,000 |
| Commissioning Tool | Remote Only |   ENVISIONLS App  |   SILVAIR App  |
| Commissioning Process | Individually Set via Remote | Wireless Must be done on site | Wireless- Initial linking must be done on site. Commissioning can be done via desktop remotely. |
| Floor Plan Upload | N/A | N/A | Yes Add a floor plan and mark luminaires & zones via desktop |
| Gateway | N/A | N/A | Required only for energy monitoring, advanced scheduling, automated demand response. |
| Individual Luminaire Control | Yes | Yes | Yes |
| Luminaire Grouping Zoning | N/A | Yes | Yes |
| High End Power Low End Power | Yes but limited (View Remote) | Yes | Yes |
| Cost | \$ | \$\$ | \$\$\$ |
| DLC NLC Listed | N/A | Yes | Yes |
| Energy Monitoring & Data Reporting | N/A | N/A | Monitor energy usage per individual zone & retrofit cost savings calculation + detailed reporting |



Compatible Products:

EnVision offers a variety of nodes, sensors, & gateways that are controlled via remote, ENVISIONLS Bluetooth Mesh & SILVAIR Bluetooth Mesh on all of our 0-10V dimmable fixtures.



Individual Fixture Controls: PIR Sensor, Bi-Level Dimming, Daylight

Basic Note: **-1** • ENVISIONLS Models Note: **-BT** • SILVAIR Models Note: **-SL**

| | MODEL # | DESIGN | RECOMMENDED FIXTURE | FEATURES |
|--|---|--|--|--|
| | S-TWC-PIR-1 S-TWC-PIR-BT S-TWC-PIR-SL | Twist-C Control Sensor | Sensor Ready Fixtures: Area Lights, Canopies, Flood Lights, High Bays | All models are equipped with PIR occupancy sensing, high & low end bi-level dimming, & daylight sensing. |
| | S-TWC-90 + S-TWC-PIR-1 S-TWC-90 + S-TWC-PIR-BT S-TWC-90 + S-TWC-PIR-SL | Twist-C Control Sensor + 90 Degree Arm | Cylinders, Strips, Wall Packs | |
| | S-AUD-PIR-1 S-AUD-PIR-BT S-AUD-PIR-SL | 2.5m Audio Jack | Panels & Troffers | |
| | S-SN-PIR-1 S-SN-PIR-BT S-SN-PIR-SL | Snap In Sensor | Troffers & Wraps | |

Group Controls ENVISIONLS Models Note : **-BT** • SILVAIR Models Note: **-SL**

| | MODEL # | DESIGN | VOLTAGE | FEATURES | RECOMMENDED FEATURES |
|--|--|---|----------|---|-------------------------------------|
| | S-CM-PIR-LV-BT S-CM-PIR-LV-SL | Ceiling Mounted PIR Sensor | 12-24V | PIR Sensor, Bi-Level Dimming, Daylight, 360° detection, 12' Max Mounting Height | Connects to 0-10V dimmable fixtures |
| | S-WM-PIR-CUNV-BT S-WM-PIR-CUNV-SL | Wall Mounted PIR Occupancy Sensor, Bi-Level Dimming, Daylight | 120-277V | On/Off PIR occupancy sensor, 180° detection, 30' detection @ 4' Mounting Height | Connects to LED fixtures |
| | S-WS-120V-USB-SL | | 120V | Dimming Wall Socket, Two Sockets | Floor Lamps, Other Lamps |

Gateway (Silvair Only) 4.5–5.5 V DC, 2A Power over Ethernet 36–57 V DC

| | MODEL # | DESIGN | VOLTAGE | FEATURES | RECOMMENDED FEATURES |
|--|----------------|-------------------------|---------|------------------------------------|--|
| | SGW-102 | Wall or Ceiling Mounted | POE | Advanced Energy Monitoring Control | Connects to Silvair Controls. Gateway is not required. |