

**Linear Highbay: Bolt-Line**  
3-Power Selectable



**Detail Specifications**

- Finish: White, Custom finishes available
- IP Rating: Damp Location
- Beam Angle: 110°
- Chip: SMD 2835, R9 >50, CRI >80
- Operating Temperature: -4° - 122° F
- Lens: Clear Prismatic Ribbed
  - Low Glare
- Average life (L70) of 70,000 hours

**Applications:**

- Warehouse/Distribution Facility
- Utility & Storage
- Garage Structures
- Commercial and Industrial

**Product Information:**

- Aluminum housing finished with corrosion free power coat
- Replace existing fixtures or use in new construction
- Easy maintenance: driver access from front
- Instant-On to full brightness
- Twist-C Control: Control ready receptacle built into each fixture

**Driver Options:**

- UNV: 120-277V 0-10V Dimmable
- HV: 347-480V 0-10V Dimmable
- THD: <20% (+/-5% tolerance), PF >0.9, 50/60Hz

**Mounting & Installation:**

- 3.5' adjustable suspension kit included
- Optional 10 & 20' adjustable suspension kit available
- Optional 6' chain kit available
- Optional surface mount kit available
- Optional pendant mount kit available

**Certifications:**

- UL Listed for USA and CA
- DLC Premium Listed
- ROHS Compliant
- Approved for CA T24
- 5 Year Limited Warranty
- FCC CFR 47, GCC Part 15, Subpart B:2017

WATT	LUMENS
60	8,700
80	11,600
110	15,950
125	18,125
150	21,750
165	23,925
180	26,100
200	29,000
220	31,900
260	37,700
290	42,050
320	46,400

High Bay Luminaires - DLC Product ID:	
LED-LHB-2FT-3P110-F-40K-UNV	PLIWUESBD5IU
LED-LHB-2FT-3P110-F-50K-UNV	PLIWUESBD5IU
LED-LHB-2FT-3P165-F-40K-UNV	PLZM71M24QLR
LED-LHB-2FT-3P165-F-50K-UNV	PLZM71M24QLR

Series	CCT	Voltage <sup>1</sup>	Whip <sup>2</sup>	Plug	Optic	EMB
LED-LHB-2FT-3P110-F	40K	UNV	(Blank)	(Blank)	(Blank)	(Blank)
60/80/110W • 120-277V	4000K	120-	No Whip	Hardwire	110°	No
LED-LHB-2FT-3P165-F	50K	277V	-6	SB	Standard	Emergency
125/150/165W • 120-277V	5000K	HV <sup>1</sup>	6ft Whip	5-15P	30D <sup>3</sup>	Back-Up
		347-	3-Wire	Straight	30°	EMB
		480V	-10	Blade		90 Min.
			10ft Whip	Plug		Emergency
			3-Wire	TL		Back-up
			-20	L5-15P		
			20ft Whip	Twist		
			3-Wire	Lock		
			-6F	Plug		
			6' Whip			
			5-Wire			
			-10F			
			10' Whip			
			5-Wire			
			-20F			
			20' Whip			
			5-Wire			

Optional Accessories (Order Separately)					
Suspension Kits	Mounting Kits	Wire Guards	Whips (Field Install)	Sensors <sup>1</sup>	Sensor Remote
<b>SK-10FT-Y-LC-PD</b> 10' Y-Shape, Loop Top, Paddle Bottom (Adjustable Length)	<b>LHB-3P-PDM</b> 165W, 220W, 320W Pendant Mount Kit	<b>LHB-2FT-WG</b> 2ft 110 & 165W	<b>6'-WHIP-1/2KO</b> 6' Whip	<b>S-TWC-PIR -ON/OFF</b> PIR Sensor On/Off Only 5/10/15min	<b>S-LINE-R</b> Remote for S-Line
<b>SK-20FT-Y-LC-PD</b> 20' Y-Shape, Loop Top, Paddle Bottom (Adjustable Length)	<b>LHB-3P-SM</b> 165W, 220W, 320W Surface Mount Kit	<b>LHB-3P-4FT -WG</b> 2ft 220 & 320W	<b>10'-WHIP-1/2KO</b> 10' Whip	<b>S-TWC-PIR-1</b> PIR Bi-Level Motion + Daylight Sensor (Remote Req'd)	<b>ENVISION CONNECT</b> Bluetooth smart app.
<b>SK-10FT-Y-LC-CB</b> 10' Y-Shape, Loop Top, Carabiner Bottom (Adjustable Length)			<b>20'-WHIP-1/2KO</b> 20' Whip	<b>S-TWC-PIR-SL</b> PIR SILVAIR Bluetooth Mesh + Daylight Sensor	<b>CONNECT</b> Download on Apple or Android app store.
<b>SK-20FT-Y-LC-CB</b> 20' Y-Shape, Loop Top, Carabiner Bottom (Adjustable Length)			<b>Custom whips to size available</b>	<b>S-TWC-PIR-BT</b> PIR ENVISIONLS Bluetooth Control	
<b>CK-6FT-V</b> 6' chain hanging kit					

1. Sensor Note:  
Microwave: Detects motion through barriers such as walls, and doors. Ideal for applications where obstacles might obstruct the line of sight. Works effectively outdoors, in large open spaces, & parking lots. Do not use in areas of high vibrations or metal.  
PIR: Ideal for indoor environments with clear lines of sight to the area of interest. Detects warm objects, like a person or animal. Good for high vibration, areas of metal.

Specs and model numbers are subject to change with or without notice.

**FEATURES**

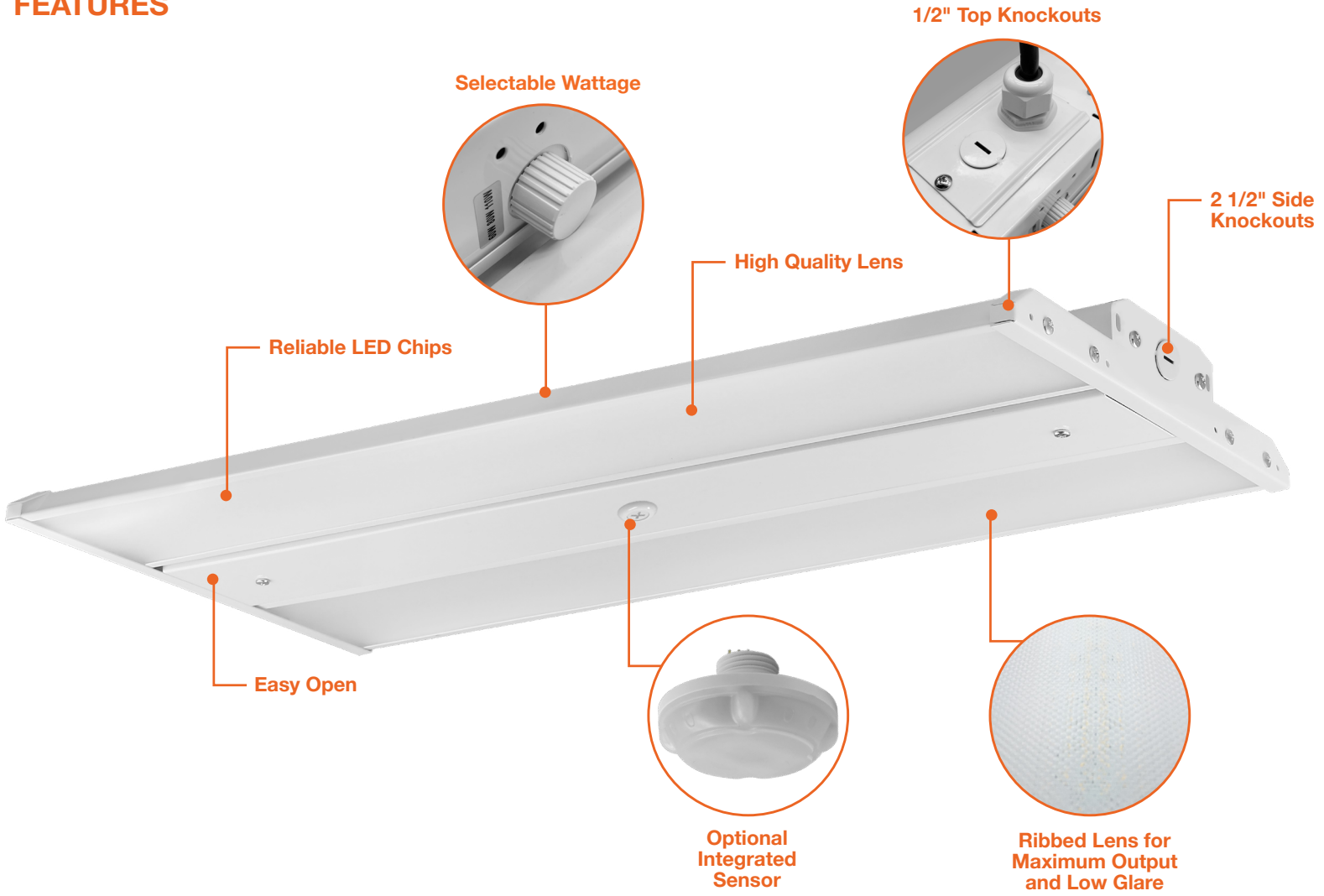

**DIMENSIONS**

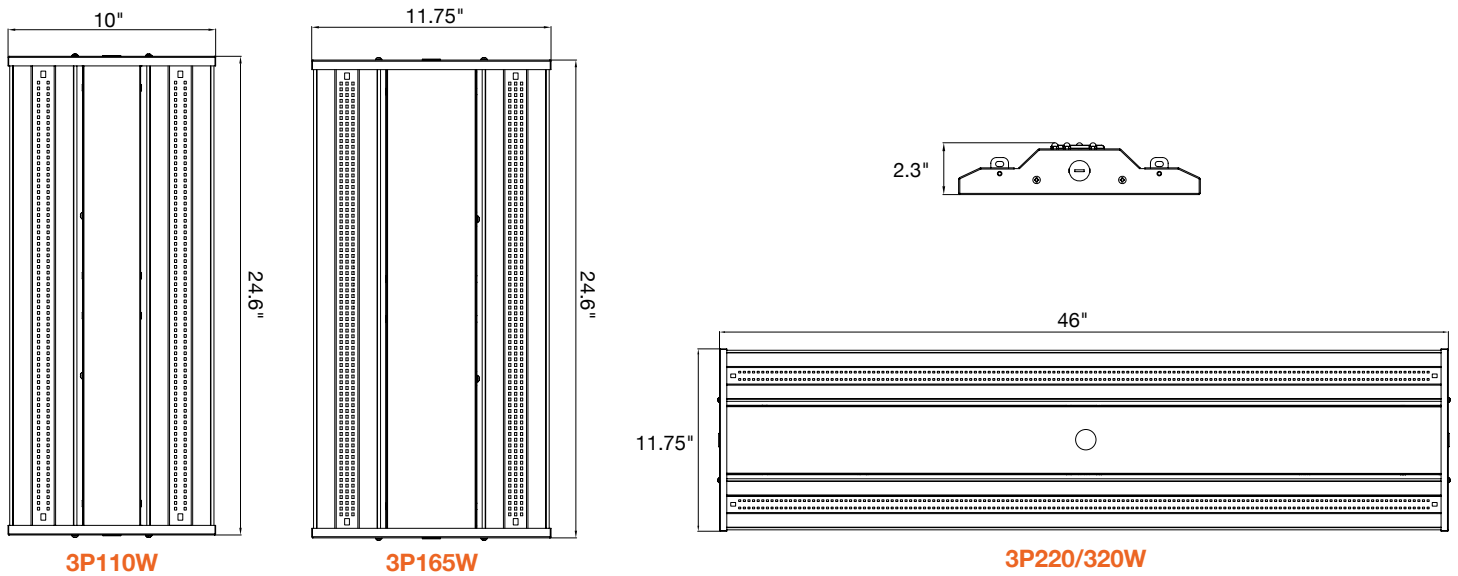

## ACCESSORIES



**SK-10FT-Y-LC-PD**  
**SK-20FT-Y-LC-PD**



**SK-10FT-Y-LC-CB**  
**SK-20FT-Y-LC-CB**



**CK-6FT-V**

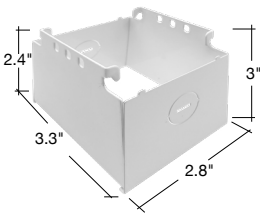

**Pendant Mount 2ft**  
**LHB-3P-PDM**  
Center Hole Size .85"

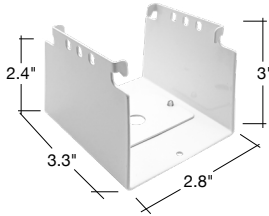

**Surface Mount 2ft**  
**(2 Pcs)**  
**LHB-3P-SM**  
Center Hole Size 1"  
Center Hole Size w/ Plate .43"

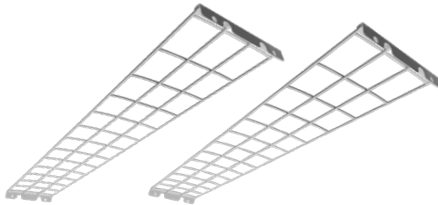

**LHB-2FT-WG**  
**LHB-3P-4FT-WG**

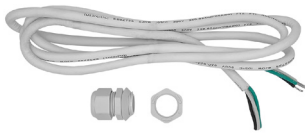

**6'-WHIP-1/2KO**  
**10'-WHIP-1/2KO**  
**20'-WHIP-1/2KO**



**S-TWC-PIR**  
**-ON/OFF**



**S-TWC-PIR-1**  
**S-TWC-PIR-SL**  
**S-TWC-PIR-BT**



**S-LINE-R**  
Controller



**SB**  
5-15P Straight  
Blade Plug



**TL**  
L5-15P Twist  
Lock Plug

## HIGHBAY FIXTURE

Accessory Model	Description
LED-LHB-2FT-3P110-F-40K-UNV	Linear Highbay 2ft 3 Power Select w/ Twist-It Technology
LED-LHB-2FT-3P110-F-50K-UNV	Linear Highbay 2ft 3 Power Select w/ Twist-It Technology
LED-LHB-2FT-3P165-F-40K-UNV	Linear Highbay 2ft 3 Power Select w/ Twist-It Technology
LED-LHB-2FT-3P165-F-50K-UNV	Linear Highbay 2ft 3 Power Select w/ Twist-It Technology
LED-LHB-4FT-3P220W-F-40K-UNV	Linear Highbay 4ft 3 Power Select w/ Twist-It Technology
LED-LHB-4FT-3P220W-F-50K-UNV	Linear Highbay 4ft 3 Power Select w/ Twist-It Technology
LED-LHB-4FT-3P320W-F-40K-UNV	Linear Highbay 4ft 3 Power Select w/ Twist-It Technology

## SUSPENSION KITS

Accessory	Description
SK-10FT-Y-LC-PD	10' Y-Shape, Loop Top, Paddle Bottom (Adjustable Length)
SK-20FT-Y-LC-PD	20' Y-Shape, Loop Top, Paddle Bottom (Adjustable Length)
SK-10FT-Y-LC-CB	10' Y-Shape, Loop Top, Carabiner Bottom (Adjustable Length)
SK-20FT-Y-LC-CB	20' Y-Shape, Loop Top, Carabiner Bottom (Adjustable Length)
CK-6FT-V	6' Chain Hanging Kit

## MOUNTING KITS

Accessory Model	Description
LHB-3P-PDM	LHB: Pendant mount bracket up to 320W
LHB-3P-SM	LHB: Surface mount bracket up to 320W

## WIRE GUARDS

Accessory Model	Description
LHB-2FT-WG	Linear Highbay Wire Guard 2ft
LHB-3P-4FT-WG	Linear Highbay Wire Guard 4ft

## WHIPS (FIELD INSTALL)

Accessory Model	Description
6'-WHIP-1/2KO	6' Whip
10'-WHIP-1/2KO	10' Whip
20'-WHIP-1/2KO	20' Whip

## SENSORS

Accessory Model	Description
S-TWC-PIR-ON/OFF	PIR Sensor On/Off Only 5/10/15min
S-TWC-PIR-1	PIR Bi-Level Motion + Daylight Sensor (Remote Req'd)
S-TWC-PIR-SL	PIR SILVAIR Bluetooth Mesh + Daylight Sensor
S-TWC-PIR-BT	PIR ENVISIONLS Bluetooth Control

## SENSOR REMOTE









Accessory Model	Description
S-LINE-R	Remote for S-Line Sensor
ENVISION CONNECT	Bluetooth smart app. Download on Apple and Android.

## PLUG

Accessory Model	Description
SB	5-15P Straight Blade Plug
TL	L5-15P Twist Lock Plug

# EnVisionLED™ Control Options

EnVision LED offers 3 control systems compatible with our LED Fixtures for projects of all sizes and budgets.

	Basic Controls	EnVisionLS 	EnVisionLED™ X SILVAIR 
<b>Description</b>	Standard Plug In Sensors	Basic Bluetooth Wireless Control	Advanced Bluetooth Wireless Control
<b>Recommended Quantity</b> (but not limited to)	N/A	>40-50 Nodes	>50 Nodes
<b>Maximum Zone Quantity</b>	N/A	100	3,000
<b>Commissioning Tool</b>	Remote Only	  ENVISIONLS App 	  SILVAIR App 
<b>Commissioning Process</b>	Individually Set via Remote	Wireless Must be done on site	Wireless- Initial linking must be done on site. Commissioning can be done via desktop remotely.
<b>Floor Plan Upload</b>	N/A	N/A	Yes Add a floor plan and mark luminaires & zones via desktop
<b>Gateway</b>	N/A	N/A	Required only for energy monitoring, advanced scheduling, automated demand response.
<b>Individual Luminaire Control</b>	Yes	Yes	Yes
<b>Luminaire Grouping Zoning</b>	N/A	Yes	Yes
<b>High End Power Low End Power</b>	Yes but limited (View Remote)	Yes	Yes
<b>Cost</b>	\$	\$\$	\$\$\$
<b>DLC NLC Listed</b>	N/A	Yes	Yes
<b>Energy Monitoring &amp; Data Reporting</b>	N/A	N/A	Monitor energy usage per individual zone & retrofit cost savings calculation + detailed reporting







# Compatible Products:

EnVision offers a variety of nodes, sensors, & gateways that are controlled via remote, ENVISIONLS Bluetooth Mesh & SILVAIR Bluetooth Mesh on all of our 0-10V dimmable fixtures.





## Individual Fixture Controls: PIR Sensor, Bi-Level Dimming, Daylight

Basic Note: **-1** • ENVISIONLS Models Note: **-BT** • SILVAIR Models Note: **-SL**

	MODEL #	DESIGN	RECOMMENDED FIXTURE	FEATURES
	<b>S-TWC-PIR-1</b> <b>S-TWC-PIR-BT</b> <b>S-TWC-PIR-SL</b>	Twist-C Control Sensor	Sensor Ready Fixtures: Area Lights, Canopies, Flood Lights, High Bays	All models are equipped with PIR occupancy sensing, high & low end bi-level dimming, & daylight sensing.
	<b>S-TWC-90 + S-TWC-PIR-1</b> <b>S-TWC-90 + S-TWC-PIR-BT</b> <b>S-TWC-90 + S-TWC-PIR-SL</b>	Twist-C Control Sensor + 90 Degree Arm	Cylinders, Strips, Wall Packs	
	<b>S-AUD-PIR-1</b> <b>S-AUD-PIR-BT</b> <b>S-AUD-PIR-SL</b>	2.5m Audio Jack	Panels & Troffers	
	<b>S-SN-PIR-1</b> <b>S-SN-PIR-BT</b> <b>S-SN-PIR-SL</b>	Snap In Sensor	Troffers & Wraps	

## Group Controls ENVISIONLS Models Note : **-BT** • SILVAIR Models Note: **-SL**

	MODEL #	DESIGN	VOLTAGE	FEATURES	RECOMMENDED FEATURES
	<b>S-CM-PIR-LV-BT</b> <b>S-CM-PIR-LV-SL</b>	Ceiling Mounted PIR Sensor	12-24V	PIR Sensor, Bi-Level Dimming, Daylight, 360° detection, 12' Max Mounting Height	Connects to 0-10V dimmable fixtures
	<b>S-WM-PIR-CUNV-BT</b> <b>S-WM-PIR-CUNV-SL</b>	Wall Mounted PIR Occupancy Sensor, Bi-Level Dimming, Daylight	120-277V	On/Off PIR occupancy sensor, 180° detection, 30' detection @ 4' Mounting Height	Connects to LED fixtures
	<b>S-WS-120V-USB-SL</b>		120V	Dimming Wall Socket, Two Sockets	Floor Lamps, Other Lamps

## Gateway (Silvair Only) 4.5–5.5 V DC, 2A Power over Ethernet 36–57 V DC

	MODEL #	DESIGN	VOLTAGE	FEATURES	RECOMMENDED FEATURES
	<b>SGW-102</b>	Wall or Ceiling Mounted	POE	Advanced Energy Monitoring Control	Connects to Silvair Controls. Gateway is not required.