

FC-Line: Modern Trapezoid Wall Packs

2200K

Wall Packs

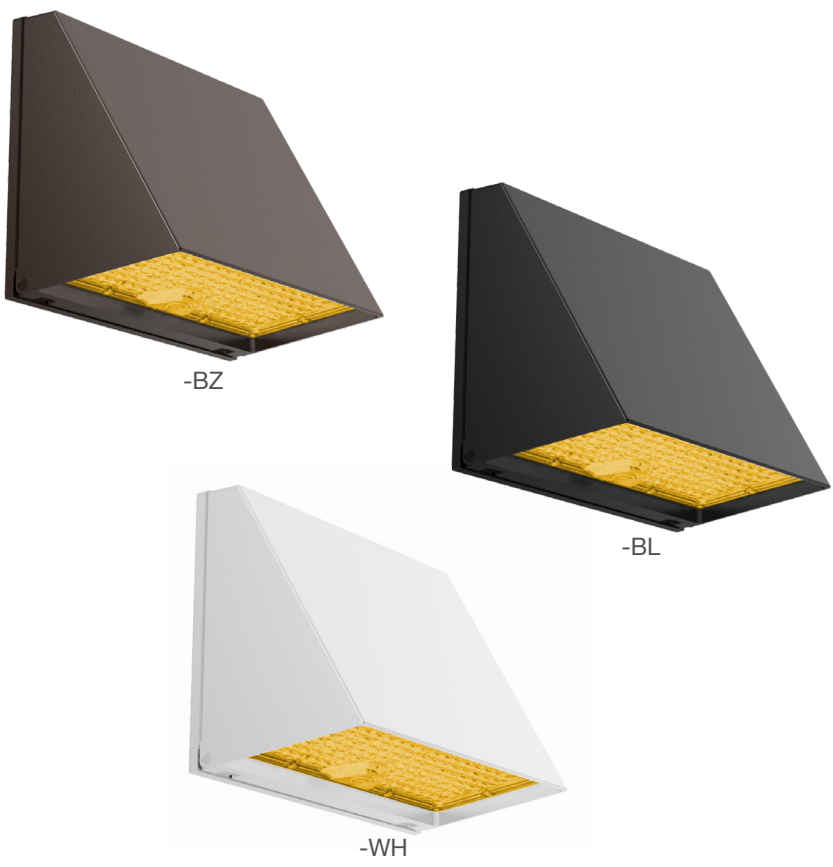

Detail Specifications

- Finish: Bronze, Black, White, Custom finishes available
- IP Rating: Wet Location
- CCT: 2200k
- Impact Rating: IK08
- Beam Angle: Type III (Standard)
- Chip: SMD 2835
- BUG: 5P60: B3-U2-G1
5P120: B4-U3-G2
- Operating Temperature: -40° - 122° F
- Lens: Clear acrylic with optics
- Average life (L70) of 70,000 hours

Applications:

- Walkways & Pathways
- Parking Lots
- Hospitality, Multi-Family
- Outdoor Corridors
- Residential, Commercial and Industrial

Product Information:

- Sturdy die-cast aluminum housing finished with corrosion free powder coat
- Full Cut-Off Dark Sky Compliant
- Photocell is included with an easy quick disconnect
- Instant-On to full brightness
- Select-n-Switch Technology: 3-CCT + 5-Power Selectable
- Control Options:
 - Standard Sensors
 - SILVAIR Bluetooth Mesh
 - ENVISIONLS Bluetooth
 - [Click Here](#) for More Information

Driver Options:

- UNV: 120-277V 0-10V Dimmable
- HV: 277-480V 0-10V Dimmable
- Built in 6Kv Surge Protector
- THD: <20% (+/-5% tolerance), PF >0.9, 50/60Hz

Certifications:

- UL Listed for USA and CA
- DLC Premium Listed
 - Pending ETA 04/2025
- ROHS Compliant
- Approved for CA T24
- 5 Year Limited Warranty
- FCC CFR 47, GCC Part 15, Subpart B:2017
- In compliance with Hawai'i County Code (HCC 14-9) and Maui County Code (Ord No.5434) for preserving dark skies
- <2% Blue Light Content

5P60		5P120	
WATT	LUMENS	WATT	LUMENS
20	2,900	80	11,600
30	4,300	90	13,050
40	5,800	100	14,500
50	7,250	110	15,950
60	8,700	120	17,400

Series	Finish ¹	Voltage	Photocell - PC	Emergency	Surge Protector	Optional Accessories (Order Separately)
LED-WPFC-TRZ-5P60-22K 60/50/40/30/20w	BZ Bronze (Standard)	(blank) 120-277V	Photocell is included. Easy quick disconnect.	(blank) No Emergency	(blank) 6KV Built in	S-TWC-PIR-ON/OFF PIR Sensor On/Off Only 5/10/15min
LED-WPFC-TRZ-5P120-22K 120/110/100/90/80w	BL Black	HV 277-480V		EMB 90 Minute Emergency Backup 30-120F	20KV 20KV Surge Protector	S-LINE-R Remote for S-Line Sensor
	WH White			CEMB 90 Minute Emergency Backup Cold Weather 4-120F		ENVISION CONNECT Bluetooth smart app. Download on Apple or Android app store.
	GRY¹ Gray					
	CS¹ Custom Color					

1. Standard quickship models shows on page 3.

Specs and model numbers are subject to change with or without notice.

FEATURES

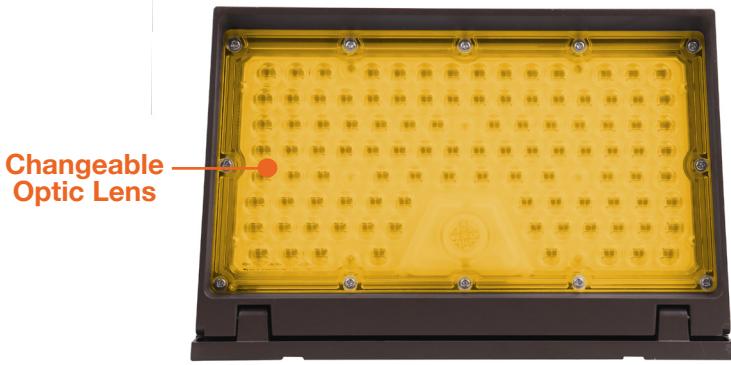
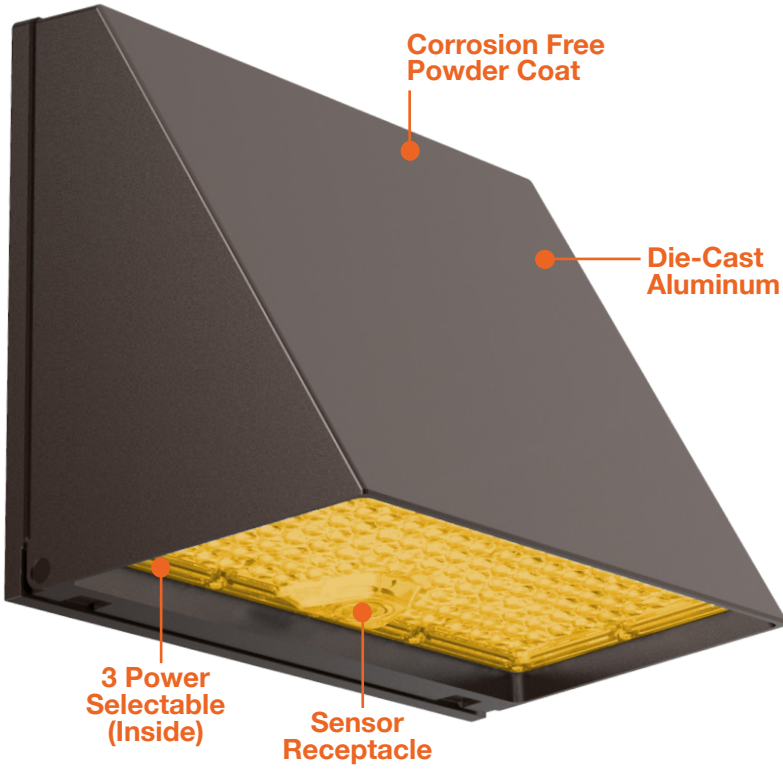

DIMENSIONS

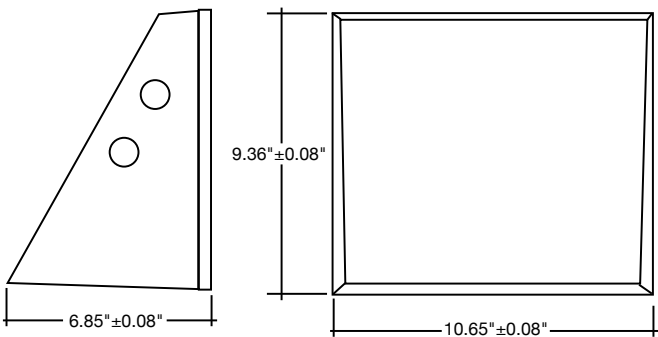

5P60

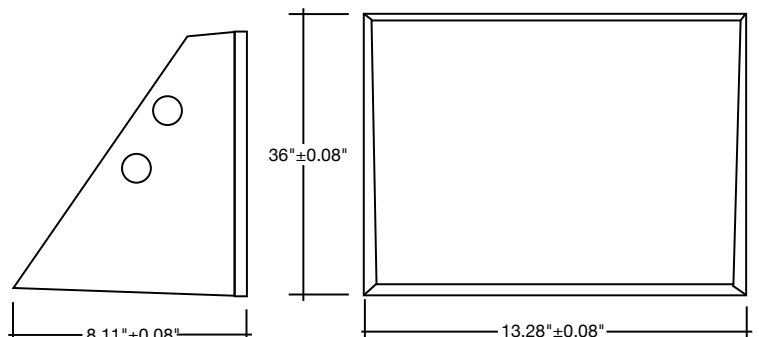

5P120

STANDARD QUICK SHIP MODELS

Model	Voltage	Watts	Lumens	Color	CRI
LED-WPFC-TRZ-5P60-22K-BZ-PC	120-277V	60/50/40/30/20W	8,700/7,250/5,800/4,350/2,900	2200k	>80
LED-WPFC-TRZ-5P60-22K-BL-PC	120-277V	60/50/40/30/20W	8,700/7,250/5,800/4,350/2,900	2200k	>80
LED-WPFC-TRZ-5P60-22K-WH-PC	120-277V	60/50/40/30/20W	8,700/7,250/5,800/4,350/2,900	2200k	>80
LED-WPFC-TRZ-5P120-22K-BZ-PC	120-277V	120/110/100/90/80W	17,400/15,950/14,500/13,050/11,600	2200k	>80
LED-WPFC-TRZ-5P120-22K-BL-PC	120-277V	120/110/100/90/80W	17,400/15,950/14,500/13,050/11,600	2200k	>80
LED-WPFC-TRZ-5P120-22K-WH-PC	120-277V	120/110/100/90/80W	17,400/15,950/14,500/13,050/11,600	2200k	>80



S-TWC-PIR-ON/OFF



S-TWC-PIR-1
S-TWC-PIR-SL



S-LINE-R

SENSORS

Pre-Installed Accessory Model	Description
S-TWC-PIR-ON/OFF	PIR On/Off Only: Twist-C 5/10/15 Min
S-TWC-PIR-1	PIR Bi-Level + Daylight: Twist-C
S-TWC-PIR-SL	PIR SILVAIR Bluetooth Mesh
S-TWC-PIR-BT	PIR ENVISIONLS Bluetooth Control

REMOTE CONTROL

Accessory Model	Description
S-LINE-R	Remote for S-LINE Series Sensors

Specs and model numbers are subject to change with or without notice.

WAVELENGTH DATA

120W CIE COLORIMETRIC PARAMETERS

Chromaticity coordinates: $x=0.5239$ $y=0.4500$ $u(u')=0.2851$ $v=0.3672$ $v'=0.5508$
CCT: $T_c=2252K$ ($duv=0.01051$) Color Ratio: $R=0.276$ $G=0.718$ $B=0.006$
Peak Wavelength: 631.4nm Half Bandwidth: 7.8nm
Dominant Wavelength: 584.2nm Color Purity: 0.924
CRI: $R_a=71.8$, $avgR(1\sim14)=64.0$, $avgR(1\sim15)=63.8$ TM30: $R_f=69$, $R_g=69$
 $R1=68$ $R2=80$ $R3=93$ $R4=65$ $R5=64$ $R6=75$ $R7=80$ $R8=48$
 $R9=0$ $R10=57$ $R11=57$ $R12=44$ $R13=68$ $R14=96$ $R15=60$
Color Quality Scale: $Q_a=40.1$, $Q_f=46.1$, $Q_p=30.9$, $Q_g=49.1$
 $Q1=68$ $Q2=64$ $Q3=66$ $Q4=67$ $Q5=70$ $Q6=68$ $Q7=56$ $Q8=42$
 $Q9=24$ $Q10=6$ $Q11=9$ $Q12=19$ $Q13=36$ $Q14=40$ $Q15=65$

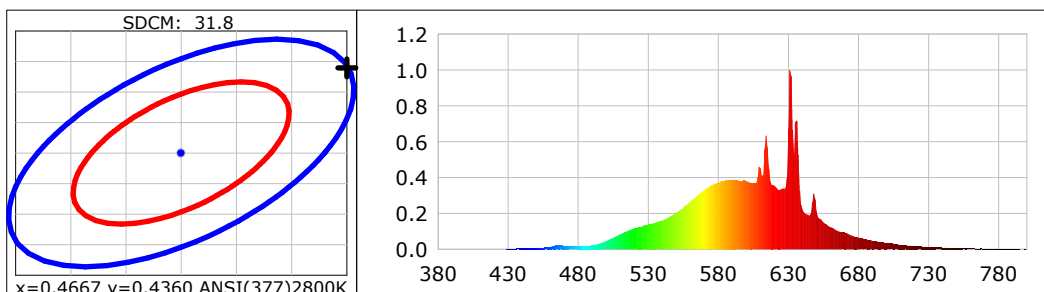





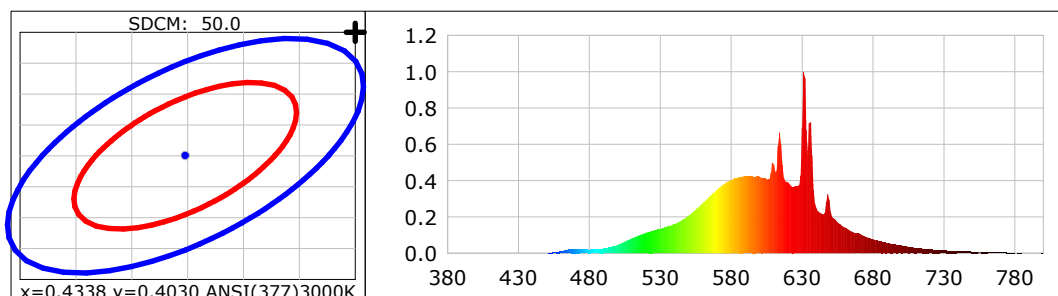



60W CIE COLORIMETRIC PARAMETERS

Chromaticity coordinates: $x=0.5305$ $y=0.4486$ $u(u')=0.2898$ $v=0.3676$ $v'=0.5514$
CCT: $T_c=2185K$ ($duv=0.01019$) Color Ratio: $R=0.282$ $G=0.712$ $B=0.006$
Peak Wavelength: 631.4nm Half Bandwidth: 7.9nm
Dominant Wavelength: 584.7nm Color Purity: 0.940
CRI: $R_a=69.5$, $avgR(1\sim14)=62.2$, $avgR(1\sim15)=61.8$ TM30: $R_f=61$, $R_g=61$
 $R1=65$ $R2=80$ $R3=92$ $R4=61$ $R5=62$ $R6=74$ $R7=77$ $R8=44$
 $R9=0$ $R10=57$ $R11=51$ $R12=44$ $R13=66$ $R14=96$ $R15=58$
Color Quality Scale: $Q_a=30.6$, $Q_f=36.9$, $Q_p=19.8$, $Q_g=41.5$
 $Q1=61$ $Q2=51$ $Q3=58$ $Q4=64$ $Q5=68$ $Q6=64$ $Q7=47$ $Q8=31$
 $Q9=13$ $Q10=1$ $Q11=3$ $Q12=9$ $Q13=25$ $Q14=32$ $Q15=63$



EnVisionLED™ Control Options

EnVision LED offers 3 control systems compatible with our LED Fixtures for projects of all sizes and budgets.

	Basic Controls	EnVisionLS 	EnVisionLED™ X SILVAIR 
Description	Standard Plug In Sensors	Basic Bluetooth Wireless Control	Advanced Bluetooth Wireless Control
Recommended Quantity (but not limited to)	N/A	>40-50 Nodes	>50 Nodes
Maximum Zone Quantity	N/A	100	3,000
Commissioning Tool	Remote Only	  ENVISIONLS App 	  SILVAIR App 
Commissioning Process	Individually Set via Remote	Wireless Must be done on site	Wireless- Initial linking must be done on site. Commissioning can be done via desktop remotely.
Floor Plan Upload	N/A	N/A	Yes Add a floor plan and mark luminaires & zones via desktop
Gateway	N/A	N/A	Required only for energy monitoring, advanced scheduling, automated demand response.
Individual Luminaire Control	Yes	Yes	Yes
Luminaire Grouping Zoning	N/A	Yes	Yes
High End Power Low End Power	Yes but limited (View Remote)	Yes	Yes
Cost	\$	\$\$	\$\$\$
DLC NLC Listed	N/A	Yes	Yes
Energy Monitoring & Data Reporting	N/A	N/A	Monitor energy usage per individual zone & retrofit cost savings calculation + detailed reporting







Compatible Products:

EnVision offers a variety of nodes, sensors, & gateways that are controlled via remote, ENVISIONLS Bluetooth Mesh & SILVAIR Bluetooth Mesh on all of our 0-10V dimmable fixtures.





Individual Fixture Controls: PIR Sensor, Bi-Level Dimming, Daylight

Basic Note: **-1** • ENVISIONLS Models Note: **-BT** • SILVAIR Models Note: **-SL**

	MODEL #	DESIGN	RECOMMENDED FIXTURE	FEATURES
	S-TWC-PIR-1 S-TWC-PIR-BT S-TWC-PIR-SL	Twist-C Control Sensor	Sensor Ready Fixtures: Area Lights, Canopies, Flood Lights, High Bays	All models are equipped with PIR occupancy sensing, high & low end bi-level dimming, & daylight sensing.
	S-TWC-90 + S-TWC-PIR-1 S-TWC-90 + S-TWC-PIR-BT S-TWC-90 + S-TWC-PIR-SL	Twist-C Control Sensor + 90 Degree Arm	Cylinders, Strips, Wall Packs	
	S-AUD-PIR-1 S-AUD-PIR-BT S-AUD-PIR-SL	2.5m Audio Jack	Panels & Troffers	
	S-SN-PIR-1 S-SN-PIR-BT S-SN-PIR-SL	Snap In Sensor	Troffers & Wraps	

Group Controls ENVISIONLS Models Note : **-BT** • SILVAIR Models Note: **-SL**

	MODEL #	DESIGN	VOLTAGE	FEATURES	RECOMMENDED FEATURES
	S-CM-PIR-LV-BT S-CM-PIR-LV-SL	Ceiling Mounted PIR Sensor	12-24V	PIR Sensor, Bi-Level Dimming, Daylight, 360° detection, 12' Max Mounting Height	Connects to 0-10V dimmable fixtures
	S-WM-PIR-CUNV-BT S-WM-PIR-CUNV-SL	Wall Mounted PIR Occupancy Sensor, Bi-Level Dimming, Daylight	120-277V	On/Off PIR occupancy sensor, 180° detection, 30' detection @ 4' Mounting Height	Connects to LED fixtures
	S-WS-120V-USB-SL		120V	Dimming Wall Socket, Two Sockets	Floor Lamps, Other Lamps

Gateway (Silvair Only) 4.5–5.5 V DC, 2A Power over Ethernet 36–57 V DC

	MODEL #	DESIGN	VOLTAGE	FEATURES	RECOMMENDED FEATURES
	SGW-102	Wall or Ceiling Mounted	POE	Advanced Energy Monitoring Control	Connects to Silvair Controls. Gateway is not required.