

enVisionLED™

LED Commercial Downlight Delivering Brilliant Light Output with Optimized Energy Efficiency





27 SKU's In One Fixture: Select your power/wattage, & your CCT with a switch

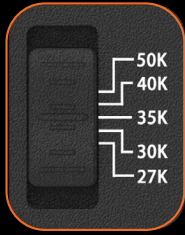

5-CCT Selectable



3-Power Selectable



Adjustable Beam: Variable beam spread of 38°-75° for custom lighting performance across different applications.

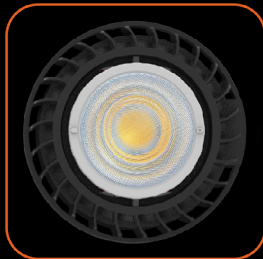

Dimming: Tri-Mode dimming for 3P18 & 3P30 models. Triac dimming for 3M56 model.



Easy Installation: Twist on and lock aluminum reflector for secure placement.



Power Selectable: 3-Power Selectable offer a powerful combination of efficiency and flexibility.

3P18		3P30		3M56	
WATT	LUMENS	WATT	LUMENS	WATT	LUMENS
8	850	15	1500	35	3500
11	1150	20	2000	45	4000
18	1500	30	2500	56	5000

Applications

Retrofit



Office



Retail



Features

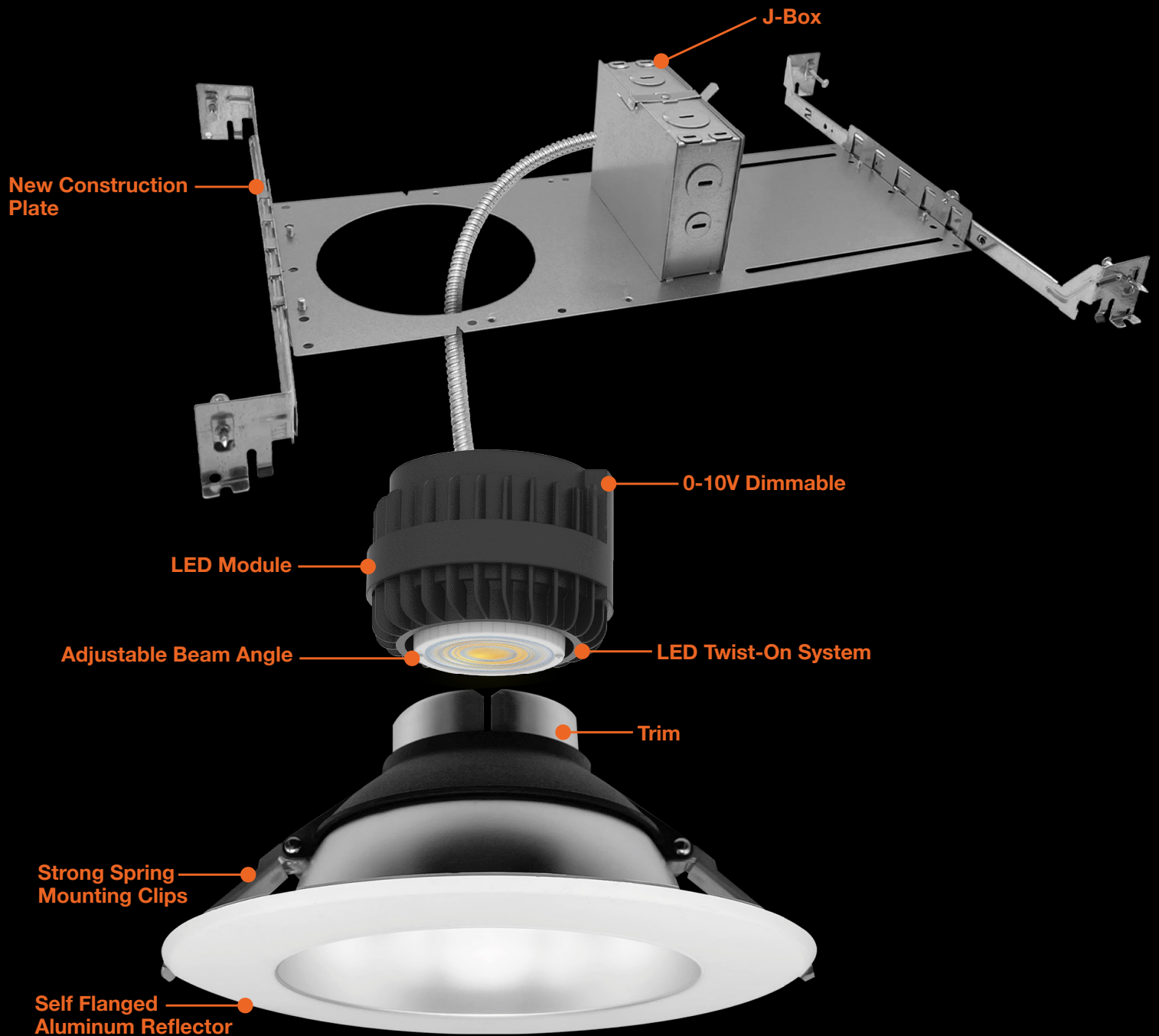

Trims

REGULAR TRIM OPTIONS



-WH



-CSH



-BLK

White Trim Options

CADM-4-WH
CADM-6-WH
CADM-8-WH
CADM-10-WH

Clear Specular Haze Inner/ White Trim

CADM-4-CSH
CADM-6-CSH
CADM-8-CSH
CADM-10-CSH

Clear Specular Haze Inner/ Black Trim

CADM-4-CSH-BLK
CADM-6-CSH-BLK
CADM-8-CSH-BLK

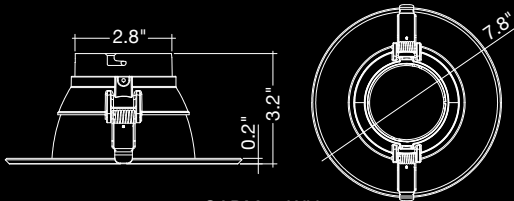

CADM-4-WH
CADM-4-CSH-BLK
CADM-4-CSH

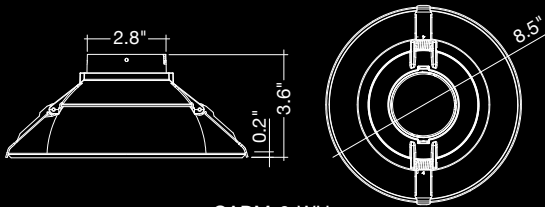

CADM-6-WH
CADM-6-CSH-BLK
CADM-6-CSH

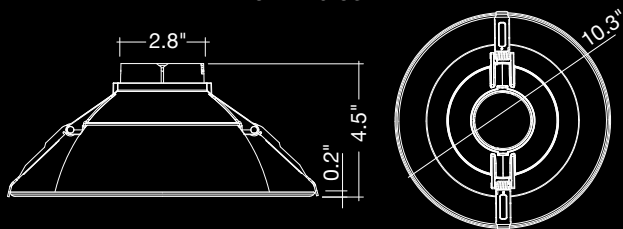

CADM-8-WH
CADM-8-CSH-BLK
CADM-8-CSH

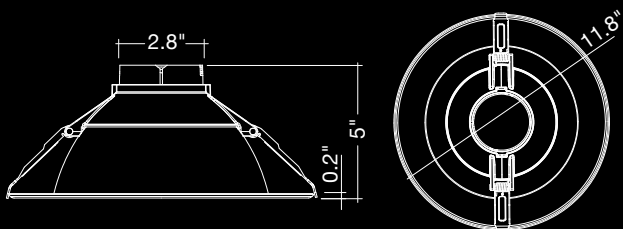

CADM-10-WH
CADM-10-CSH

SQUARE TRIM OPTIONS



CADM-4-CSH-SQ
CADM-6-CSH-SQ
CADM-8-CSH-SQ

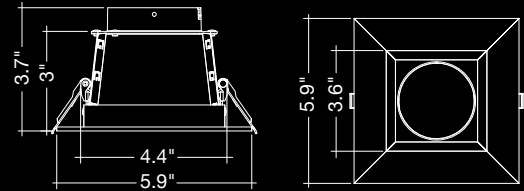

CADM-4-CSH-SQ

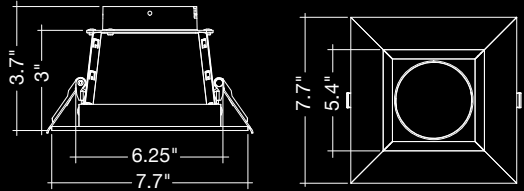

CADM-6-CSH-SQ

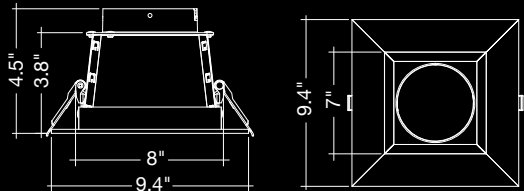

CADM-8-CSH-SQ

WALL WASH TRIM OPTIONS



-WH



-CSH

CADM-4-WASH-WH
CADM-4-WASH-CSH
CADM-6-WASH-WH
CADM-6-WASH-CSH

CADM-8-WASH-WH
CADM-8-WASH-CSH

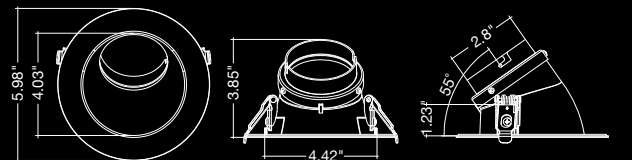

CADM-4-WASH-WH
CADM-4-WASH-CSH



CADM-6-WASH-WH
CADM-6-WASH-CSH



CADM-8-WASH-WH
CADM-8-WASH-CSH

Accessories

Goof Ring

GR-4-WH
GR-6-WH
GR-8-WH
GR-10-WH

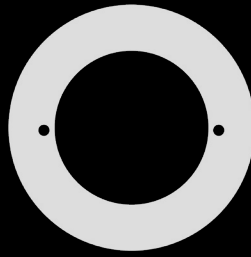

Junction Box

JBOX-ALM



New Construction Plate

4" 6" 8" 10" CADM or CMD Round

CUNV-NC-RI-JJBX

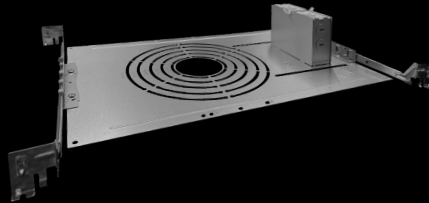

New Construction Plate

4" 6" 8" CADM Square

CUNV-NC-SQI-JJBX

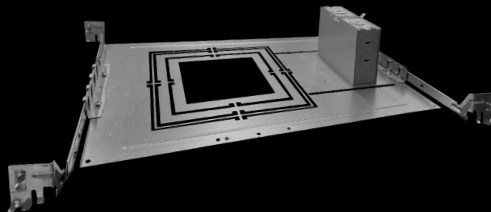

New Construction Plate

1" 2" 3" 3.5" 4" 6"

Canless Downlights

CUNV-NC-ICAT-7H

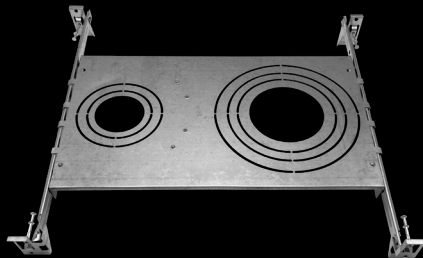

Universal Construction Plate

2" 3" 3.5" 4" 5" 6"

Canless Downlights

CUNV-JBX-RI-XL

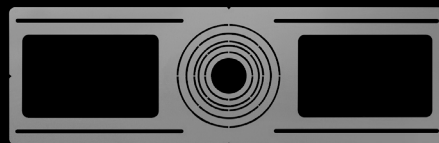

Dimensions

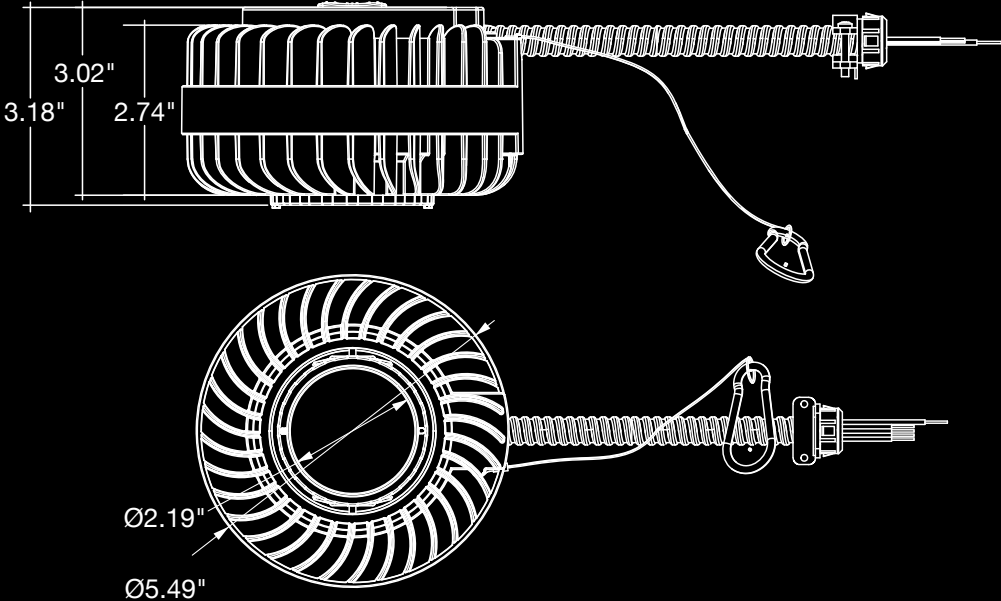

CADM-3M56

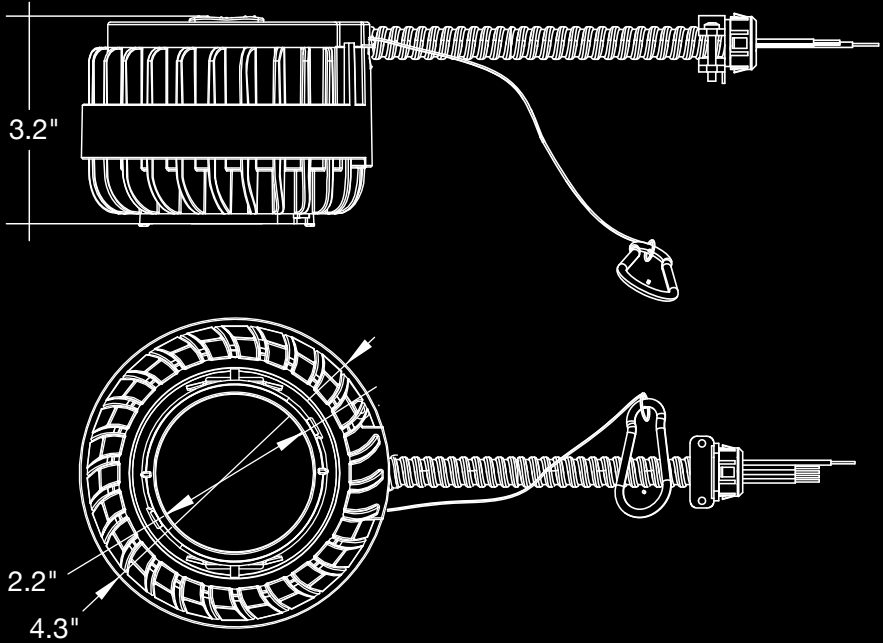

CADM-3P18
CADM-3P30



envisionledlighting.com

EnVision LED Lighting

P- 323-604-0066 M-F, 5am to 5pm PST

Information

cs@envisionledlighting.com

Orders

orders@envisionledlighting.com

View Latest Catalog

[CLICK HERE](#)

