

# Sanfelice Baby Jacket to Knit

MIMI SEYFERTH

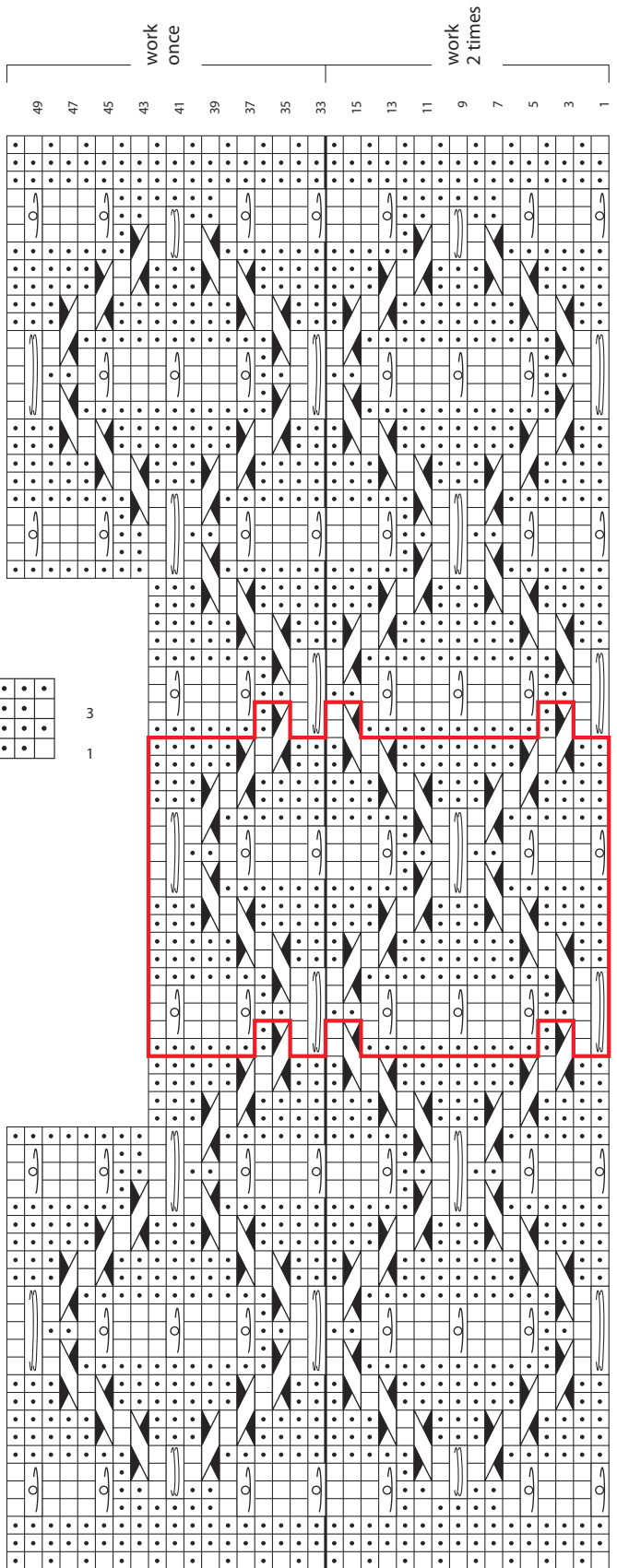

## Sleeve

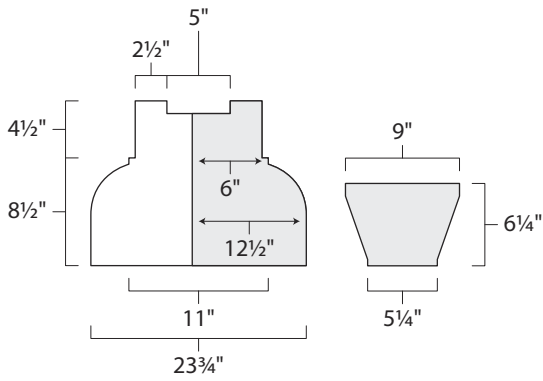
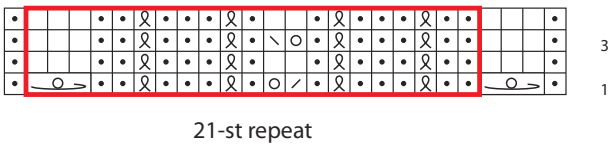

## Back Skirt

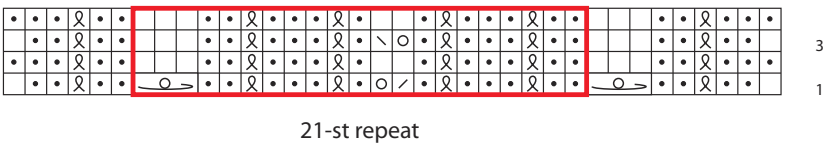

## Key

- k on RS; p on WS
- p on RS; k on WS
- k1tbl on RS; p1tbl on WS
- yo
- k2tog
- ssk
- p2tog on RS; k2tog on WS
- sl 1 purlwise wyf on RS and WS
- pattern repeat
- pass 3rd st on left needle over first 2 sts and off needle, then work first 2 sts as k1, yo, k1
- sl 2 sts onto cn and hold in front of work, p2, then k2 from cn
- sl 2 sts onto cn and hold in back of work, k2, then p2 from cn
- smock 2 (see Special Stitches)
- smock 3 (see Special Stitches)
- smock 5 (see Special Stitches)

18-st repeat  
work 2 times

Back Yoke

Left Front Yoke

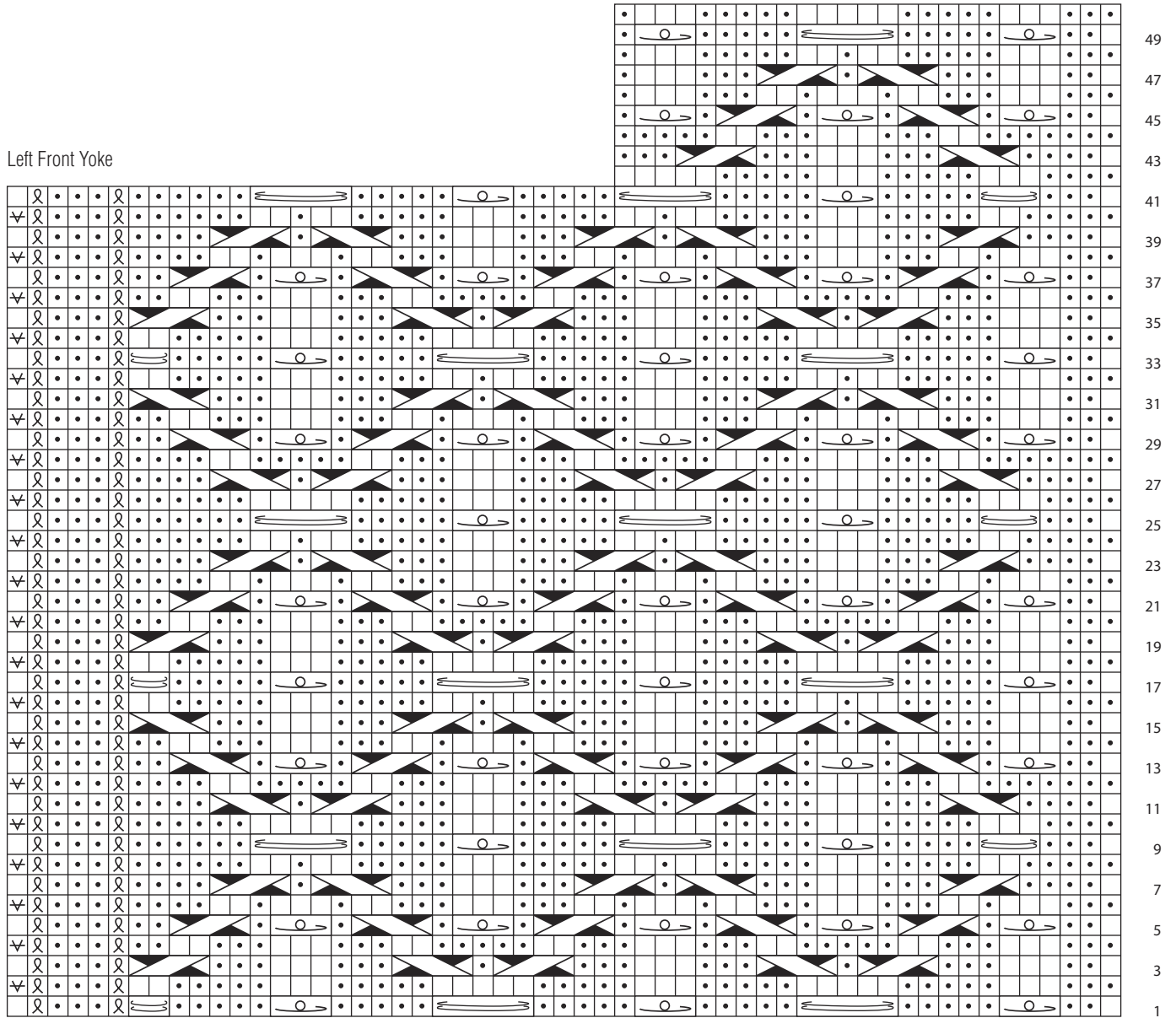

55 sts

Left Front Skirt

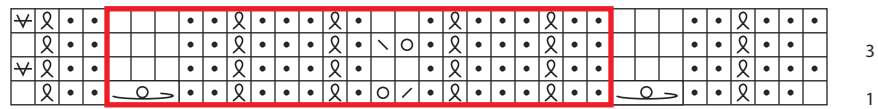

21-st repeat

Right Front Yoke

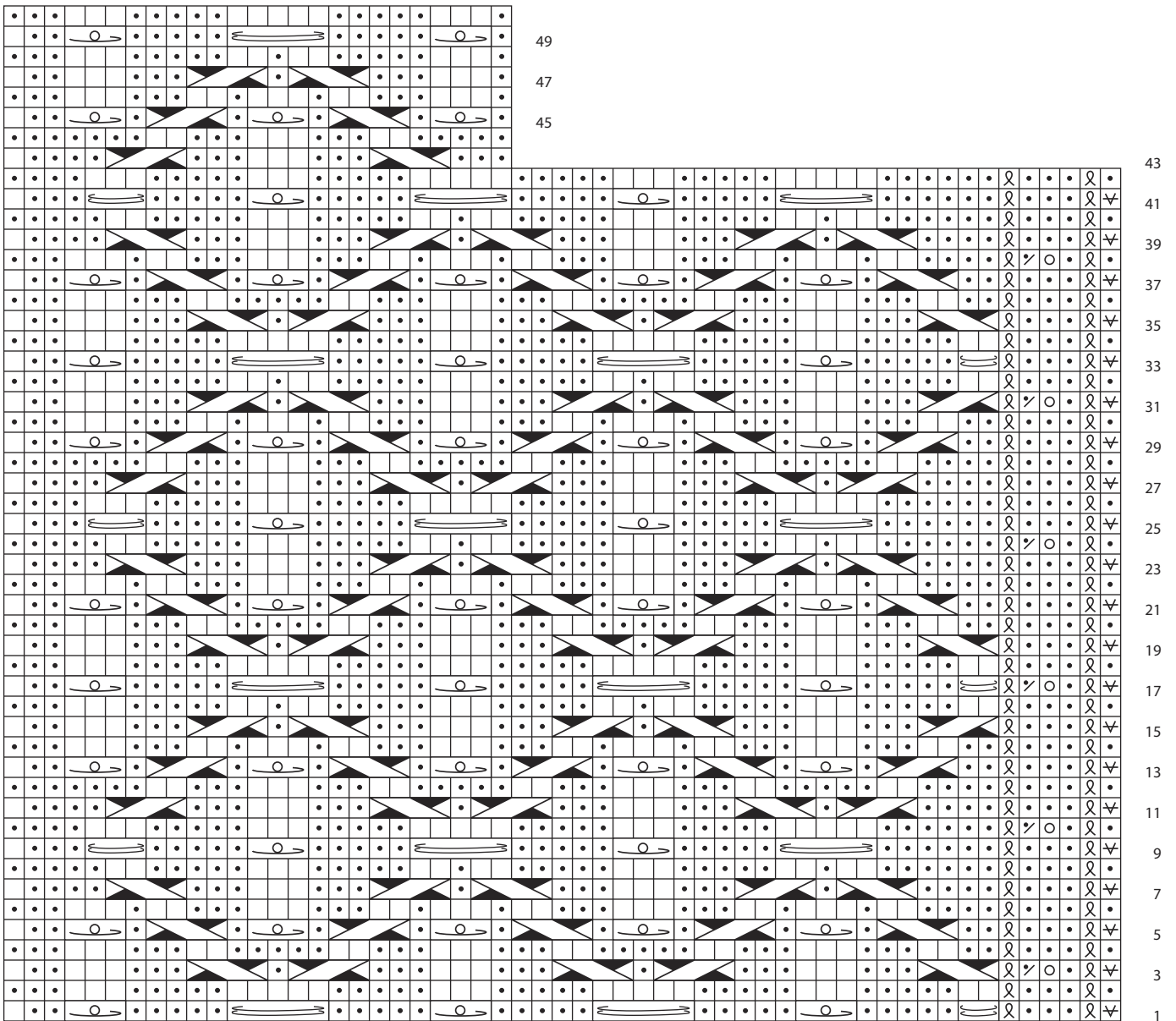

55 sts

Right Front Skirt

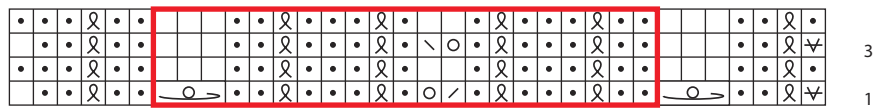

21-st repeat