



2023

UNICORNLINE

CONTENTS

LOVE YOUR SKIN™ kit	1	NOTABLE™ wool felt memo new	35	HANGING PERMITS	66
SHEET MASKS	2	TYVEK® POUCHES	36	HANG TAGS	67
LIP BALMS	3	GIFT SETS kraft	37	FOLDING CARTONS sleeve	68
MAKEUP REMOVER WIPES	3	GIFT SETS 5 dram	38	FOLDING CARTONS tuck end	70
BODY CARE new	4	GIFT SETS hexagon™	39	FOLDING CARTONS seal end	72
GLOVES & SOCKS new	5	GIFT SETS salt & pepper	40	FOLDING CARTONS TTSLB	74
WIPES & LOTIONS	6	SALTS	41	FAVOR BOXES	76
REED DIFFUSERS	8	SPICES & HERBS	42	PILLOW BOXES	77
ESSENTIAL OILS	9	SEASONINGS	43	UNIQU PRINT™ dry erase	78
ROLL-ONS	10	PEPPERCORNS	44	UNIQU PRINT™ chalk board	79
CARRIER OILS	11	CHILI PEPPERS	45	IMAGE WRAP™ faux canvas	80
BODY OILS	12	TEAS	46	POPOUT™	81
CANDLES	13	FLORAL TEAS	47	ACOUSTIC CEILING TILES	82
3 WICK CANDLES new	14	SUPERFOOD POWDER	48	CUBE awards	83
2 WICK CANDLES new	15	PROTEIN POWDER	49	TOWER awards	84
POTPOURRI new	16	NUTS	50	POPOUT™ awards	85
BATH & SHOWER new	17	SPROUTING SEEDS	51	GLOW CUBOID™ awards new	86
FOAMING HAND SOAPS new	18	EDIBLE FLOWER SEEDS	52	GLOW TOWER awards new	87
SOAP BARS new	19	HERB SEEDS	53	CUBOID™ awards	88
GOLF BALL BOXES	20	NUTS new	54		
GOLF TEE PACKS	21	DRIED FRUITS new	55		
POCKET CADDY™ kit	22	CHOCOLATES new	56		
JUST IN CASE™ edc	23	CANDIES new	57		
BOTTLE CLEANING TABLETS	24	LABELS/DECALS	58		
LEATHER GOODS	25	DOOR HANGERS paper	60		
DESK MATS / COASTERS new	28	DOOR HANGERS plastic	61		
COIN SET new	29	BOOK MARKS	62		
NOTABLE™ notepads	30	GLASS MARKERS	63		
NOTABLE™ notebooks	32	MENUS plastic	64		
NOTABLE™ desk planners new	34	SHELF WOBBLERS	65		

LOVE YOUR SKIN™ kit



U1000 4 1/2" x 6"



Specifications

Full Color Custom Packed Home Spa Essentials kit which includes Makeup Remover, and Sheet Mask. This Kit contains everything your clients need to bring a spa experience home. Wipe away the day's make-up, and follow with the facial mask.

- Free Setup / Art / Logos
- Bleeds Allowed on All Sides
- Makeup Remover Made in USA
- Sheet Mask Made in Korea
- Package Printed in USA

Material

Package : 111# Gloss Cover

Printing

Digital : Full Color Printing on Front & Back

Die Cutting

No Charge for Standard Package Shape
Custom Shape is Available, add

Custom Shape, add \$150.00 (G) each shape

Option

Artwork Change : \$67.00 (G) each



DIGITAL

6C

ITEM NO	100	250	500	1000	2500	5000
U1000 Love Your Skin™	8.57	7.15	6.01	5.35	4.91	4.52



**Emerging K-Beauty Trend
as Promotional Product**

SHEET MASKS

Essence from rose petal extract focuses on smoothing the complexion and brightening the skin while replenishing the skin's moisture for a radiant look.



U1015 5 Packs

4 1/2" x 6 1/4" x 3/4" (Package)

4 1/8" x 5 7/8" (Sheet Mask)

Sheet Masks inserted into package

U1012 SM Sleeve

4 1/4" x 6" (Sleeve)

4 1/8" x 5 7/8" (Sheet Mask)

Sheet Mask is inserted into sleeve envelope

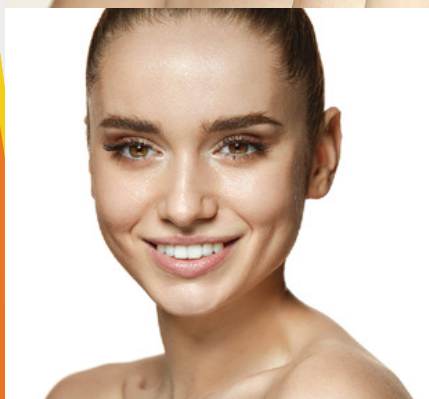

This refreshing water-based sheet mask is accentuated with a pleasant rose fragrance that leaves the skin hydrated and radiant. Serum from the mask delivers conditioning to the skin for moisturizing effects. The sheet mask is designed to fit to the contours of the face and adheres well to the skin. This mask is made from 100% natural cellulose fibers, making it biodegradable and sustainable.

Specifications

Full Color Custom Packed Sheet Mask. An enormously popular K-beauty phenomenon, sheet masks are now available as a promotional gift in an attractive paper sleeve.

- Free Setup / Art / Logos
- Bleeds Allowed on All Sides
- Made with 100% Natural Cellulose Fibers
- Romantic Rose Scent
- Sheet Mask Made in Korea
- Package Printed in USA

Material

Package : 111# Gloss Cover

Printing

Digital : Full Color Printing on Front & Back

Die Cutting

No Charge for Standard Package Shape
Custom Shape is Available, add

Custom Shape, add \$150.00 (G) each shape

Option

Artwork Change : \$67.00 (G) each

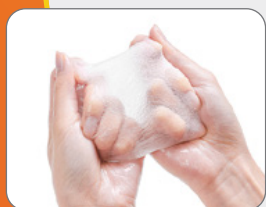

Tough

More tear resistant than a typical mask



Ease of Use

Better adherence to the skin during use

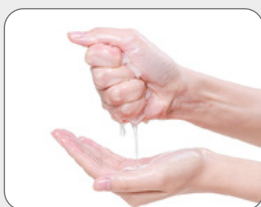

Plentiful

Mask contains an ample serum

DIGITAL

6C

ITEM NO		250	500	1000	2500	5000	10000
U1012	SM Sleeve	5.91	4.76	4.11	3.71	3.46	3.27
U1014	2 Pack Sleeve	8.25	7.11	6.46	6.07	5.82	5.62
U1015	5 Pack Carton	14.93	14.41	13.76	13.31	12.93	12.73

LIP BALMS

Paraben Free, Sulfate Free,
Phthalate Free, Fragrance Free



U1310 1" x 1" x 2 3/4"



MAKEUP REMOVER WIPES



U1365 5" x 2 3/4"

Instantly dissolve even heavy-duty makeup with a silky, lite-touch formula.
Made in USA.

Specifications

Full Color Custom Packed Health & Beauty Products.

- Free Setup / Art / Logos
- Bleeds Allowed on All Sides
- Package Printed in USA

Lip Balm : Formulated with rich Shea Butter, to soothe and comfort dry, chapped lips. Made in China.

Makeup Remover Wipe : Instantly dissolve even thick makeup with a silky, lite-touch formula. Made in USA.

Material

U1310 Package : 111# Gloss Cover

U1365 Package : 8 pt Gloss Cover

Printing

Digital : Full Color on Front & Back

Die Cutting

Custom Shape is Available, add

Custom Shape, add \$150.00 (G) each shape

Option

Artwork Change : \$67.00 (G) each



DIGITAL

6C

ITEM NO		250	500	1000	2500	5000	10000
U1310	Lip Balm	4.68	4.17	3.51	3.12	2.99	2.91
U1365	Makeup Remover	2.76	2.36	1.76	1.39	1.26	1.20

BODY CARE



U1100 Mani
 2 5/8" x 1 1/4" (Band)
 2 5/8" x 5 1/8" x 1/2" (Product)



U1130 Pedi
 2 7/8" x 1 1/4" (Band)
 2 7/8" x 5 1/8" x 1 3/16" (Product)



U1300 Shea Butter Lotion
 1 19/32" x 1 19/32" x 5" (Box)
 1 13/16" x 5 1/8" x 1 1/4" (Product)
 Shea Butter / Lavender Sage / Rose Water

Pedi in a Box

Relax and experience our Lavender Relieve Pedi in a Box. Indulge in some me-time and pamper your feet with our Lavender Relieve pedicure! Infused with natural lavender extract, this foot treatment soothes and calms skin, leaving it soft, supple and comfortable.

Mani in a Box

Go la-la lavender over our Lavender Relieve Mani in a Box. This all-in-one spa manicure kit is infused with natural lavender extract to drift you away to dream-land for an ultimate relaxation experience! Just don't be surprised if you drift away into total bliss.

Shea Butter Lotion

Shea goodbye to dry skin with our vegan hand lotion in Shea Butter. This natural, slightly nutty scent deeply nourishes dry skin and leaves it feeling soft and non-greasy. Formulated with vegan and pure natural extracts, our Shea Butter Lotion creates the ultimate luxurious spa experience.

Specifications

Full Color Custom Packed K-beauty Products. 100% vegan spa care products designed with your well-being in mind. Indulge in some me-time and pamper yourself at home!

- Free Setup / Art / Logos
- Bleeds Allowed on All Sides
- Product Made in Korea
- Package Printed in USA

Material

U1100 / 1130 : 8 pt Gloss Cover
U1300 : 111# Gloss Cover

Printing

Digital : Full Color Printing on Band or Box

Die Cutting

No Charge for Standard Package Shape
 Custom Shape is Available, add

Custom Shape, add \$150.00 (G) each shape

Option

Artwork Change : \$67.00 (G) each

DIGITAL

6C

ITEM NO		96	240	480	960	2400	4800
U1100	Mani in a Box	8.33	7.10	6.69	6.06	5.67	5.54
U1130	Pedi in a Box	8.33	7.10	6.69	6.06	5.67	5.54
U1300	Shea Butter Lotion	8.25	6.67	6.11	5.42	5.00	4.56

GLOVES & SOCKS



U1020 Collagen Gloves
 3 7/8" x 1 1/4" (Band)
 3 7/8" x 6 7/8" x 1/8" (Product)



U1021 Shea Butter Gloves
 3 7/8" x 1 1/4" (Band)
 3 7/8" x 5 7/8" x 1/8" (Product)



U1030 Collagen Socks
 3 7/8" x 1 1/4" (Band)
 3 7/8" x 6 7/8" x 1/8" (Product)



U1031 Shea Butter Socks
 3 7/8" x 1 1/4" (Band)
 3 7/8" x 5 7/8" x 1/8" (Product)

Gloves & Socks

Our manicure gloves and pedicure socks deliver intense moisture to keep skin soft, nourished and hydrated. A simple and quick addition to your beauty routine!



Specifications

Full Color Custom Packed K-beauty Products. 100% vegan spa care products designed with your well-being in mind. Indulge in some me-time and pamper yourself at home!

- Free Setup / Art / Logos
- Bleeds Allowed on All Sides
- Product Made in Korea
- Band Printed in USA

Material

Band : 8 pt Gloss Cover

Printing

Digital : Full Color Printing on Band

Die Cutting

No Charge for Standard Package Shape

Custom Shape is Available, add

Custom Shape, add \$150.00 (G) each shape

Option

Artwork Change : \$67.00 (G) each



DIGITAL

6C

ITEM NO		96	240	480	960	2400	4800
U1020	Collagen Gloves	9.10	7.88	7.46	6.83	6.44	6.32
U1021	Shea Butter Gloves	6.10	4.88	4.46	3.83	3.44	3.32
U1030	Collagen Socks	9.10	7.88	7.46	6.83	6.44	6.32
U1031	Shea Butter Socks	6.10	4.88	4.46	3.83	3.44	3.32

WIPES & LOTIONS

U1311 Lip Balms

0.9g (Content) • 1 ¼" x 2 ½" (Pouch)

Pomegranate Flavored. Formulated with Vitamin E, Bees Wax, and other natural emollients to soothe and hydrate dry lips. Apply as often as needed. Made in USA.



U1340 Insect Bite Relief Wipes

1 ⅛" x 2 ¾" (Wipe) • 2" x 2 ¼" (Packet)

Provides temporary relief from pain and itching caused by insect stings and bites. (Contains Lidocaine for fast-acting pain relief) Made in USA.

U1315 Skin Lotions

0.9g (Content) • 1 ¼" x 2 ½" (Pouch)

Vanilla Almond Scented. Formulated with Aloe Vera and Vitamin E to add moisture to the skin with each use. Made in USA.



U1355 p.a.w.s. Antimicrobial Wipes

5" x 8" (Wipe) • 2" x 2 ¼" (Packet)

66.5% ethyl alcohol formulation. Kills 99.9% of Most Common Germs. Meets CDC, APIC, and OSHA. Made in USA.

U1331 First Aid & Burn Creams

0.9g (Content) • 1 ¼" x 2 ½" (Pouch)

Helps relieve pain and protects cuts, scrapes, and burns against contamination. Keep them in your purse, backpack, pocket, or glove compartment. Made in USA.



U1362 Zeiss® Lens Cleaning Wipes

6" x 5" (Wipe) • 2 ¼" x 2" (Packet)

The pre-moistened, micro-fine tissue from ZEISS® ensures effective and fast eyeglass cleaning when you are out and about. Made in China.

U1339 Insect Repellent Lotions

0.9g (Content) • 1 ¼" x 2 ½" (Pouch)

Formula contains the natural plant-based repellents: Citronella oil and Soybean oil, making it safer for both children and adults. Made in USA.



U1363 Lens Cleaner Wipes

5" x 8" (Wipe) • 2" x 2 ¼" (Packet)

For glass and plastic surfaces. These wipes provide a crystal clear, streak-free finish while anti-static and silicone-free. Made in USA.

U1358 Hand Sanitizer Gels

0.9g (Content) • 1 ¼" x 2 ½" (Pouch)

66.5% ethyl alcohol formulation, meeting OSHA and CDC. Moisturizing aloe leaves skin soft with no sticky residue. Made in USA.



U1380 Hand Wipes

6 ½" x 5" (Wipe) • 2 ¼" x 2" (Packet)

Keep hands clean, not sticky or covered in dirt or grime. Made with a fresh lemon scent and no alcohol. Made in USA.





Package 3 1/2" x 2 1/2"



U1330 Sunscreen Lotions

3.5g (Content) • 1 1/4" x 3 1/4" (Pouch)
 Helps prevent sunburn especially for people with skin highly sensitive to the sun's rays. SPF 30. Made in USA.

U1337 Adhesive Bandages

1" x 3" (Bandage) • 3 3/4" x 1 5/8" (Packet)
 Covered wounds heal faster. Flexible Fabric Adhesive Bandages, which cover and protect minor wounds. Made in China.



U1338 Alcohol Prep Pads

1 1/8" x 1 3/8" (Pad) • 1 7/8" x 2 1/4" (Packet)
 2 ply • 70% isopropyl alcohol
 Prep Pads help clean the skin and can be used on cuts, scrapes, and abrasions prior to bandaging.
 Made in India.



U1356 BZK Antiseptic Towelettes

5" x 7" (Wipe) • 2" x 2 1/4" (Packet)
 BZK Antiseptic Towelettes are sanitizing wipes designed to prevent infection in minor cuts, scrapes and burns and protect against harmful bacteria. Made in China.



Specifications

Full Color, Custom Packed Wipes & Lotions. We have procured the most popular wipes and lotions in convenient single use packages. All our wipes & lotions come individually prepacked in an attractive custom printed package.

- Free Setup / Art / Logos
- Bleeds Allowed on All Sides
- Package Printed in USA

Material
 Package : 8 pt Gloss Cover

Printing
 Digital : Full Color Printing on Front & Back

Die Cutting
 No Charge for Standard Package Shape
 Custom Shape is Available, add
Custom Shape, add \$150.00 (G) each shape

Option
Artwork Change : \$67.00 (G) each
Packaging : Bulk

ITEM NO	250	500	1000	2500	5000	10000
U1311 · U1338 · U1339 · U1340	3.49	2.35	1.70	1.32	1.19	1.06
U1315 · U1331 · U1355 · U1358 · U1363	3.53	2.39	1.75	1.36	1.23	1.10
U1330	3.77	2.64	1.99	1.60	1.47	1.35
U1356 · U1380	3.47	2.33	1.69	1.30	1.17	1.04
U1337 · U1362	3.76	2.63	1.98	1.59	1.46	1.34

REED DIFFUSERS



Benefits of Reed Diffusers

- No Risk of Fire
- No Messy Wax Deposits
- No External Power is Required

What are reed diffusers and how do they work?

Reed diffusers are the hottest trend right now in home fragancing. They are simple and safe to use; reeds are inserted into a glass bottle of scented diffuser oil, the reeds soak up the scent and emit a pleasant aroma around your home.

How long do reed diffusers last?

There are many factors that contribute to how long the oils last, namely temperature and humidity. However, we have found that our 50ml diffuser oil should last for approximately 2-3 months.

My reed diffuser doesn't smell as strongly as it used to. What can I do?

Overtime the reeds become completely saturated and can become clogged with dust. If you still have oil in the bottle, simply flip the reeds to help give the diffusion process a little boost. If this doesn't help, consider replacing your reeds.

Are Reed Diffusers environmentally friendly?

Our reed diffusers are very environmentally friendly. Unlike candles, they emanate no soot or film onto furniture, walls, and ceilings. Our ingredients are alcohol-free and DPG-free.

Why can't I just re-use my sticks over and over again?

Once the reed sticks are totally saturated, the cells in the reeds eventually become clogged and lose their ability to pull the scent up from the reeds to the room.



U2310

- 2" x 2" x 8 5/8" (Box)
- 1 3/8" x 1 3/8" (Label)
- 1 7/8" x 1 7/8" x 2 3/4" (Bottle)

Net Wt. 50ml / 5 reeds
Reed diffuser with
custom label and custom gift box

Specifications

Fragrances can interact with the brain to impact our moods, stress levels, and even working capacities. Whether you have a home office, are looking to make your guests feel welcomed, or just want a more uplifting environment for yourself, reed diffusers are an effective way to get there.

- Free Setup / Art / Logos
- Bleeds Allowed on All Sides
- Diffusers Made in China
- Package Printed in USA

Material

Package : 130# Gloss Cover

Printing

Digital : Full Color Printing on the Box and Label

Die Cutting

No Charge for Standard Package Shape
Custom Shape is Available, add

Custom Shape, add \$150.00 (G) each shape

Option

Artwork Change : \$67.00 (G) each

DIGITAL

6C

ITEM NO	100	250	500	1000	2500	5000
U2310 Reed Diffuser	20.29	16.98	15.88	14.83	13.54	13.12

ESSENTIAL OILS

100% Pure Essential Oils : Single Oils

Undiluted

No Additives

No Fillers or Bases

No Synthetics

What are essential oils?

Essential oils are concentrated plant extracts that retain the natural scent and flavor, or "essence." Essential oils are obtained through distillation or mechanical methods like cold pressing.

How do essential oils work?

Essential oils are most commonly used in the practice of aromatherapy, in which they are inhaled or diluted and applied to the skin. They may stimulate your sense of smell or have medicinal effects when absorbed.

Are they safe to use?

Essential oils are generally considered safe to inhale or apply to the skin if they've been combined with a base oil. They should not be eaten. If you have a serious health condition or are taking medication, you should discuss their use with your healthcare practitioner.

Specifications

The best way to incorporate aromatherapy into your daily self care routine! Simply add a few drops of essential oil to an aromatherapy diffuser or dilute the liquid with a high-quality carrier oil and apply to the skin. Allow yourself to connect with the benefits of nature.

- Free Setup / Art / Logos
- Bleeds Allowed on All Sides
- 100% Pure Essential Oil
- Fresh Packed upon Receipt of Order in USA

Material

Package : Bulk, Custom Gloss Label

Gift Box (option) : 111# Gloss Cover

Printing

Digital : Full Color Printing on the Label

Die Cutting

No Charge for Standard Shape

Custom Shape, add \$150.00 (G) each shape

Option

Artwork Change : \$67.00 (G) each

U2001~2006

2 1/2" x 7/8" (Label)

2 9/32" x 2 1/8" (Product)

Net Wt. 0.17 oz (5ml)

Shown with custom gift box (option)



U3430

Gift Box (option)

2 9/32" x 2 9/32" x 2 1/4" (Gift Box)

with full-color custom graphics



ITEM NO		96	240	480	960	2400	4800
U2001	Lavender	10.22	8.82	8.34	8.10	7.96	7.91
U2002	Lemon	9.22	7.82	7.33	7.10	6.95	6.91
U2003	Peppermint	9.22	7.82	7.33	7.10	6.95	6.91
U2004	Sweet Orange	8.22	6.82	6.33	6.10	5.96	5.91
U2005	Frankincense	12.22	10.82	10.34	10.10	9.96	9.91
U2006	Eucalyptus	8.22	6.82	6.33	6.10	5.96	5.91
U3430	Gift Box (option)	4.35	2.78	2.22	1.52	1.11	0.97

ROLL-ONS

Specifications

Hand crafted and made with our single oils, our roll-on line is the top of its class. They are easy, safe, convenient and travel friendly. No mess, no fuss with these pre-diluted, ready to use roll-ons. A great gift for essential oil lovers.

- Free Setup / Art / Logos
- Bleeds Allowed on All Sides
- Hand Crafted with Single Essential Oils
- Stainless Steel Roller Ball Inserts
- Fresh Packed upon Receipt of Order in USA

Material

Package : Bulk, Custom Gloss Label
Gift Box (option) : 111# Gloss Cover

Printing

Digital : Full Color Printing on the Label

Die Cutting

No Charge for Standard Shape
Custom Shape, add \$150.00 (G) each shape

Option

Artwork Change : \$67.00 (G) each

Roll-on Essential Oils

No Synthetics, Fragrances, Fillers or Toxic Chemicals
Blended with Fractionated Coconut Oil
Pure Therapeutic Grade

Convenience of roll-ons?

Essential oil roll-ons are an amazing option because all the mixing has already been done for you. No risk of spills, no chance of getting the proportion of oils out of whack, they are all ready to go.

Where to apply roll-ons?

Perfume : If you are applying a roll-on simply because you love the aromas, then apply to your pulse points.

Breathe : Best to inhale the oil directly. Apply underneath your nose or to pulse points near the face.

Sleep & Stress : For best results, apply the roll-on to pulse points near or around your face.

Are they safe to use?

Keep out of reach of children. For external use only.

If pregnant, nursing, or under a doctor's care, consult physician before use.

Discontinue use if skin irritation occurs.

ITEM NO		96	240	480	960	2400	4800
U2101	Lavender	11.43	10.03	9.54	9.31	9.16	9.12
U2102	Peppermint	10.43	9.03	8.55	8.31	8.17	8.12
U2103	Eucalyptus	9.43	8.03	7.54	7.31	7.17	7.12
U2104	Sleep	12.43	11.03	10.54	10.31	10.16	10.12
U2105	Breathe	12.43	11.03	10.54	10.31	10.16	10.12
U2106	Stress	11.43	10.03	9.54	9.31	9.16	9.12
U3431	Gift Box (option)	4.43	2.86	2.30	1.60	1.19	1.05



U3431

Gift Box (option)

7/8" x 7/8" x 3 7/16" (Gift Box)

with full-color custom graphics



U2101~2106

2 3/8" x 2 3/4" (Label)

3/4" x 3 5/16" (Product)

Net Wt. 0.33 oz (10ml)

CARRIER OILS

All-natural Carrier Oils

Sunflower Oil

Sunflower oil is highly absorbent, and won't clog pores. It's non-irritating for most people, and can be used on all types of skin, including dry, normal, oily, and acne-prone. It has a neutral odor.

Sweet Almond Oil

The oil is lightweight and absorbs easily, and is a great moisturizer for dry skin. Sweet almond oil is one of the most popular carrier oils for skin care. They're full of healthy fats, fiber, phytochemicals, vitamins, and minerals.

Apricot Kernel Oil

Apricot kernel oil is made from apricot seeds. It's an emollient oil high in fatty acids and vitamin E. It absorbs easily into the skin and has a slightly sweet, nutty scent. The oil is thought to help soften and calm irritated, itchy skin.

MCT Oil

As one of the best carrier oil options, MCT gets its name from the structure of its molecules: Medium Chain Triglycerides. Due to its smaller molecular structure, MCT is more digested and absorbed more easily by the human body.

Jobba Oil

Jojoba oil has a delicate, nutty aroma with powerful moisturizing properties. It's thought to closely mimic sebum, the skin's natural oil. Jojoba oil absorbs easily in the skin and doesn't clog pores.

Safflower Oil

Safflower oil is known for its softening, moisturizing, nourishing and soothing properties due to its richness in vitamins E and K as well as omega-6, which makes it a privileged care for dry, delicate, irritated or redness-prone skins.

Specifications

In aromatherapy, Carrier Oils are used to dilute essential oils and help "carry" them onto the skin. Diluting essential oils is a common safety practice due to oil's high potency. Our carrier oils may be used alone or with other oils to help nourish the skin.

- Free Setup / Art / Logos
- Bleeds Allowed on All Sides
- 100% Pure Carrier Oil
- Fresh Packed upon Receipt of Order in USA

Material

Package : Bulk, Custom Gloss Label

Gift Box (option) : 111# Gloss Cover

Printing

Digital : Full Color Printing on the Label

Die Cutting

No Charge for Standard Shape

Custom Shape, add \$150.00 (G) each shape

Option

Artwork Change : \$67.00 (G) each

DIGITAL		6C					
ITEM NO		96	240	480	960	2400	4800
U2141	Sunflower Oil	10.52	9.11	8.63	8.40	8.26	8.21
U2142	Sweet Almond Oil	10.52	9.11	8.63	8.40	8.26	8.21
U2143	Apricot Kernel Oil	10.52	9.11	8.63	8.40	8.26	8.21
U2144	MCT Oil	11.52	10.11	9.63	9.40	9.26	9.21
U2145	Jojoba Oil	11.52	10.11	9.63	9.40	9.26	9.21
U2146	Safflower Oil	10.52	9.11	8.63	8.40	8.26	8.21
U3432	Gift Box (option)	5.07	3.50	2.94	2.24	1.65	1.31

U3432

Gift Box (option)

1 1⁹/₃₂" x 1 1⁹/₃₂" x 5" (Gift Box)
with full-color custom graphics



U2141~2146

2 3/8" x 2" (Label)

1 1/2" x 4 7/8" (Product)

Net Wt. 2 fl oz

BODY OILS

Specifications

Deeply moisturizing, our Body Oils contain many different kinds of essential oils, fatty acids, and vitamin E to help smooth, hydrate, and nourish the skin. When applied after a shower, Body Oils may also offer certain health benefits. We provide a three oil blend that helps promote good sleep, soothe muscle aches, and also calm your nerves.

- Free Setup / Art / Logos
- Bleeds Allowed on All Sides
- Fresh Packed upon Receipt of Order in USA

Material

Package : Bulk, Custom Gloss Label
Gift Box (option) : 111# Gloss Cover

Printing

Digital : Full Color Printing on the Label

Die Cutting

No Charge for Standard Shape
Custom Shape, add \$150.00 (G) each shape

Option

Artwork Change : \$67.00 (G) each

Rejuvenating Body Oils

- No Fragrances**
- No Additives**
- No Fillers or Bases**
- No Synthetics**

Made with 100% pure essential oils

Good Night

Good Night body oil can help relax your body and ease your mind. It helps to ease tension and restore the skin while you sleep. It's the perfect way to soothe your skin, melt away stress, and calm your senses before bed.

Lavender

Beyond luxurious aroma, Lavender body oil can quiet your thoughts and relieve tension. Lavender body oil is a deeply hydrating, aromatherapy skin moisturizer developed to deliver relaxation and radiant, nourished skin.

Muscle Relief

From loosening tight muscles to soothing away aches, Muscle Relief body oil's powerfully rejuvenating effect on the body can help decrease inflammation and swelling. Muscle Relief works underneath the skin allowing you to feel brand new again.



ITEM NO		96	240	480	960	2400	4800
U2161	Good Night	12.51	11.06	10.59	10.36	10.21	10.16
U2162	Lavender	13.51	12.06	11.59	11.36	11.21	11.16
U2163	Muscle Relief	12.51	11.06	10.59	10.36	10.21	10.16
U3433	Gift Box (option)	4.75	3.18	2.62	1.92	1.51	1.18

6C



U3433

Gift Box (option)

1 13/32" x 1 13/32" x 4 1/2" (Gift Box)
 with full-color custom graphics

U2161~2163

2 3/8" x 1 3/4" (Label)
 1 1/4" x 4 3/8" (Product)
 Net Wt. 1 fl oz

CANDLES



Soy Wax Candles

- 100% Natural Soy Wax Candles
- Soy Wax from US Grown Soybeans
- Burns Longer than Paraffin Wax
- Burns Cleaner and results in Less Soot than Paraffin Wax
- Natural Wick made of Cotton & Paper
- 100% Phthalate Free Fragrance Oils

Benefits of Soy Wax.

- Derived from a legume (soy bean), while paraffin wax is from petroleum.
- Natural and renewable resource.
- Biodegradable and cleans up with plain soap and water.
- Lower melting point than paraffin wax which means that soy candles will burn slow or longer than paraffin candles.
- Burns clean with zero petro-carbon soot

Are your candle wicks safe?

Our candle wick is a flat cotton wick braided with thin paper threads that give the wick a rigid structure without the need for a core. Simple and natural ingredients : cotton & paper.

Specifications

Inspired by a floral garden, our candles use natural ingredients like flowers, plants and trees. Made from 100% natural soy wax with clean scents and a wick made of cotton and paper, our candles burn cooler, cleaner, and longer than traditional paraffin wax candles.

- Free Setup / Art / Logos
- Bleeds Allowed on All Sides
- Recyclable Glass Jar and Metal Lid
- Hand Crafted in USA

Material

Package : Bulk, Custom Gloss Label
Gift Box (option) : 111# Gloss Cover

Printing

Digital : Full Color Printing on the Label

Die Cutting

No Charge for Standard Shape
Custom Shape, add \$150.00 (G) each shape

Option

Artwork Change : \$67.00 (G) each



U3435G

Gift Box (option)
 2 3/16" x 2 3/16" x 2 1/8" (Gift Box)
 with full-color custom graphics

U2201~2206

2 17/32" x 1" (Label)
 2 3/16" x 2" (Product)
 Net Wt. 1.5 oz



ITEM NO		96	240	480	960	2400	4800
U2201	Oakmoss & Amber	12.71	11.31	10.83	10.59	10.45	10.40
U2202	Lavender	12.71	11.31	10.83	10.59	10.45	10.40
U2203	White Birch	12.71	11.31	10.83	10.59	10.45	10.40
U2204	Sea Salt & Orchid	12.71	11.31	10.83	10.59	10.45	10.40
U2205	Black Sea	12.71	11.31	10.83	10.59	10.45	10.40
U2206	Fraser Fir	12.71	11.31	10.83	10.59	10.45	10.40
U3435G	Gift Box (option)	5.07	3.50	2.94	2.24	1.65	1.31



3 WICK CANDLES

Soy Wax Candles

- 100% Natural Soy Wax Candles
- Soy Wax from US Grown Soybeans
- Burns Longer than Paraffin Wax
- Burns Cleaner and results in Less Soot than Paraffin Wax
- Natural Wick made of Cotton & Paper
- 100% Phthalate Free Fragrance Oils

Our 3 wick candles come in a beautifully clear glass jar with silver hammered lid. Each 14 oz candle has a pure white, soy-blended wax with three wicks for a fast melt, nice wax pool, and a candle throw that is perfect for mid to large size rooms. All of our scents have a clean burn for up to 45 hours. We use lead-free cotton wicks. Highly fragrant, the scent will last the life of the candle.



U2220 French Lavender

3 7/8" x 2 1/4" (Label)
4" x 3 5/8" (Product)

Net Wt. 14 oz



U2221 Vanilla Cone

3 7/8" x 2 1/4" (Label)
4" x 3 5/8" (Product)

Net Wt. 14 oz



Specifications

Full Color Custom Labeled Candle. Made from 100% natural soy wax with clean scents and a wick made of cotton, our candles burn cooler, cleaner, and longer than traditional paraffin wax candles.

- Free Setup / Art / Logos
- Bleeds Allowed on All Sides
- Recyclable Glass Jar
- Hand Crafted in USA

Material

Package : Bulk, Custom Gloss Label

Printing

Digital : Full Color Printing on the Label

Die Cutting

No Charge for Standard Label Shape
Custom Shape is Available, add
Custom Shape, add \$150.00 (G) each shape

Option

Artwork Change : \$67.00 (G) each

DIGITAL

6C

ITEM NO		96	240	480	960	2400	4800
U2220	French Lavender	31.83	30.41	29.94	29.70	29.56	29.52
U2221	Vanilla Cone	31.83	30.41	29.94	29.70	29.56	29.52

2 WICK CANDLES



Large Country Candles

2 wick, large country candles come in a beautifully clear glass jar with a domed glass lid. The original family recipe utilizes the best available candle components with 100% food-grade wax, concentrated fragrance oils containing natural ingredients, and wicks utilizing innovative textiles. This winning formula ensures all of our candles burn clean while delivering the world's best fragrance to your home. Each 24oz candle has paraffin wax with two wicks for a fast melt, nice wax pool and candle throw that is perfect even for larger size rooms. All of our scents have a clean burn for up to 150 hours! Highly fragrant, the scent will last the life of the candle.



U2230 Lemon Lavender

3 7/8" x 2 1/4" (Label)

3 7/8" x 6 7/8" (Product)

Net Wt. 24 oz



U2231 Vanilla Orchid

3 7/8" x 2 1/4" (Label)

3 7/8" x 6 7/8" (Product)

Net Wt. 24 oz



Specifications

Full Color Custom Labeled Candle. Made from 100% food-grade wax with fragrance oils containing natural ingredients, and wicks utilizing innovative textiles.

- Free Setup / Art / Logos
- Bleeds Allowed on All Sides
- Recyclable Glass Jar
- Hand Crafted in USA

Material

Package : Bulk, Custom Gloss Label

Printing

Digital : Full Color Printing on the Label

Die Cutting

No Charge for Standard Label Shape
 Custom Shape is Available, add
Custom Shape, add \$150.00 (G) each shape

Option

Artwork Change : \$67.00 (G) each



6C

ITEM NO		96	240	480	960	2400	4800
U2230	Lemon Lavender	26.99	25.58	25.11	24.87	24.73	24.68
U2231	Vanilla Orchid	26.99	25.58	25.11	24.87	24.73	24.68

POTPOURRI



U2300 Lavender
 2 3/4" x 2 3/4" (Insert)
 3" x 3" x 3" (Product)
 Net Wt. 1.25 oz



U2301 Sea Salt & Orchid
 2 3/4" x 2 3/4" (Insert)
 3" x 3" x 3" (Product)
 Net Wt. 1.25 oz



Specifications

Full Color Custom Packed Potpourri. Curated and mixed botanicals combined in a potpourri blend with clean scent to use in home decor. Our potpourri enhances any room with light, refreshing fragrances.

- Free Setup / Art / Logos
- Bleeds Allowed on All Sides
- Pre-scented with Fragrance
- Insert Printed in USA

Material

Package : Bulk, Clear PET Box, 80# Gloss Cover Insert

Printing

Digital : Full Color Printing on the Front of Insert

Die Cutting

No Charge for Standard Insert Shape

Custom Shape is Available, add

Custom Shape, add \$150.00 (G) each shape

Option

Artwork Change : \$67.00 (G) each



ITEM NO		DIGITAL						6C
		96	240	480	960	2400	4800	
U2300	Lavender	12.84	11.91	11.59	11.43	11.33	11.30	
U2301	Sea Salt & Orchid	12.84	11.91	11.59	11.43	11.33	11.30	

BATH & SHOWER

Sugar Scrub

All of our sugar scrubs are hand-crafted in the USA by master artisans using the highest quality ingredients to ensure each jar is of top quality.

Bath Salt

Formulated with Himalayan salt and pure essential oils that are rich in a variety of natural minerals and trace elements, our bath salt exfoliates dead skin cells, leaving skin smooth and soft.

Shower Filter

Get ready to empower your shower! The Clean Ocean Vitamin C Shower Filter brings the spa to your bathroom with skin-loving ingredients and pleasant scents that help you escape into your own little world. It will be the best shower you'll ever take!



U2520 Sugar Scrub
Lavender Vanilla
4 1/2" x 1" (Side Label)
2 3/4" diameter (Top Label)
3 1/2" x 2" (Product)
Net Wt. 8 oz



U2521 Sugar Scrub
Oatmeal Milk & Honey
4 1/2" x 1" (Side Label)
2 3/4" diameter (Top Label)
3 1/2" x 2" (Product)
Net Wt. 8 oz



U2530 Bath Salt
4" x 1 3/4" (Label)
2 1/4" x 2 5/8" (Product)
Net Wt. 4.2 oz



U2580 Shower Filter
2" x 1 1/4" (Band)
2" x 3" x 7 1/16" (Product)

Specifications

Full Color Custom Packed Bath & Shower Products. Showers can be pure magic. The best bath products can also make a difference. Our need for the best bath products and hygiene products has never been stronger.

- Free Setup / Art / Logos
- Bleeds Allowed on All Sides
- Sugar Scrub / Bath Salt Made in USA
- Shower Filter Made in Korea
- Package Printed in USA

Material

Package : Bulk, Custom Gloss Label, 80# Gloss Cover (Band)

Printing

Digital : Full Color Printing on the Label / Band

Die Cutting

No Charge for Standard Package Shape

Custom Shape is Available, add

Custom Shape, add \$150.00 (G) each shape

Option

Artwork Change : \$67.00 (G) each

ITEM NO		DIGITAL					
		96	240	480	960	2400	4800
U2520~1	Sugar Scrub	16.36	14.68	14.13	13.85	13.68	13.63
U2530	Bath Salt	9.69	8.28	7.81	7.57	7.43	7.38
U2580	Shower Filter	30.66	29.43	29.02	28.39	28.00	27.88

FOAMING HAND SOAPS

Specifications

Full Color Custom Labeled Foaming Hand Soap. Washes away germs and helps maintain skin's natural moisture barrier without dyes, parabens or sulfates. Experience the luxurious, creamy foaming formula with our foaming hand washes for your hands to love.

- Free Setup / Art / Logos
- Bleeds Allowed on All Sides
- Plant-based Scent
- Package Printed in USA

Material

Package : Bulk, Custom Gloss Label

Printing

Digital : Full Color Printing on the Label

Die Cutting

No Charge for Standard Label Shape

Custom Shape is Available, add

Custom Shape, add \$150.00 (G) each shape

Option

Artwork Change : \$67.00 (G) each

Naturally Clean Foaming Hand Soap

Plant Based

Cruelty Free

Paraben Free

Sulfate Free

Triclosan Free

Try our premium quality, plant-based, scented foaming hand soap today. We have formulated each of our premium foaming soaps with a plant-based soap system and our most popular fragrances to smell as good as they look and feel.



U2510 Lavender

5 1/2" x 2" (Label)

2 7/8" x 6" (Product)

Net Wt. 10 fl oz



U2511 Lemon Sugar

5 1/2" x 2" (Label)

2 7/8" x 6" (Product)

Net Wt. 10 fl oz



DIGITAL

6C

ITEM NO		96	240	480	960	2400	4800
U2510	Lavender	11.30	9.63	9.07	8.79	8.62	8.57
U2511	Lemon Sugar	11.30	9.63	9.07	8.79	8.62	8.57

SOAP BARS



High Quality Cold Process Soap

Each bar is hand-crafted right here in the USA by a team of master artisans. All of our premium cold process bars are made using: Organic shea butter, olive oil, coconut oil, hemp oil, corn oil, soybean oil, water and lye. Many of our soaps also contain various additives such as oatmeal, sea salt, activated charcoal and more.



U2500~2505
 2 3/4" x 2 3/8" (Band)
 3 1/2" x 2 1/4" x 1" (Product)
 Net Wt. 4.8 oz

U2500
Lavender



U2501
Lemon Zest



U2502
Oatmeal Milk & Honey



U2503
Black Forest



U2504
Cafe Mocha



U2505
Mango Delight

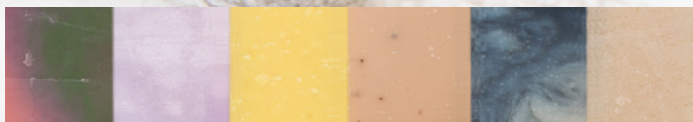

Specifications

Full Color Custom Packed Soap Bar. Cold process soap relies on natural ingredients and time for the chemical reaction known as saponification and does not require the use of heat to complete the process, resulting in soap that's good for the skin!

- Free Setup / Art / Logos
- Bleeds Allowed on All Sides
- Cold Process Soap
- Hand Crafted in USA

Material

Package : Bulk, 80# Gloss Cover Band

Printing

Digital : Full Color Printing on the Band

Die Cutting

No Charge for Standard Package Shape

Custom Shape is Available, add

Custom Shape, add \$150.00 (G) each shape

Option

Artwork Change : \$67.00 (G) each



DIGITAL

6C

ITEM NO		96	240	480	960	2400	4800
U2500	Lavender	8.02	6.79	6.38	5.75	5.37	5.24
U2501	Lemon Zest Scrub	8.02	6.79	6.38	5.75	5.37	5.24
U2502	Oatmeal Milk & Honey	8.02	6.79	6.38	5.75	5.37	5.24
U2503	Black Forest	8.02	6.79	6.38	5.75	5.37	5.24
U2504	Cafe Mocha	8.02	6.79	6.38	5.75	5.37	5.24
U2505	Mango Delight	8.02	6.79	6.38	5.75	5.37	5.24

GOLF BALL BOXES

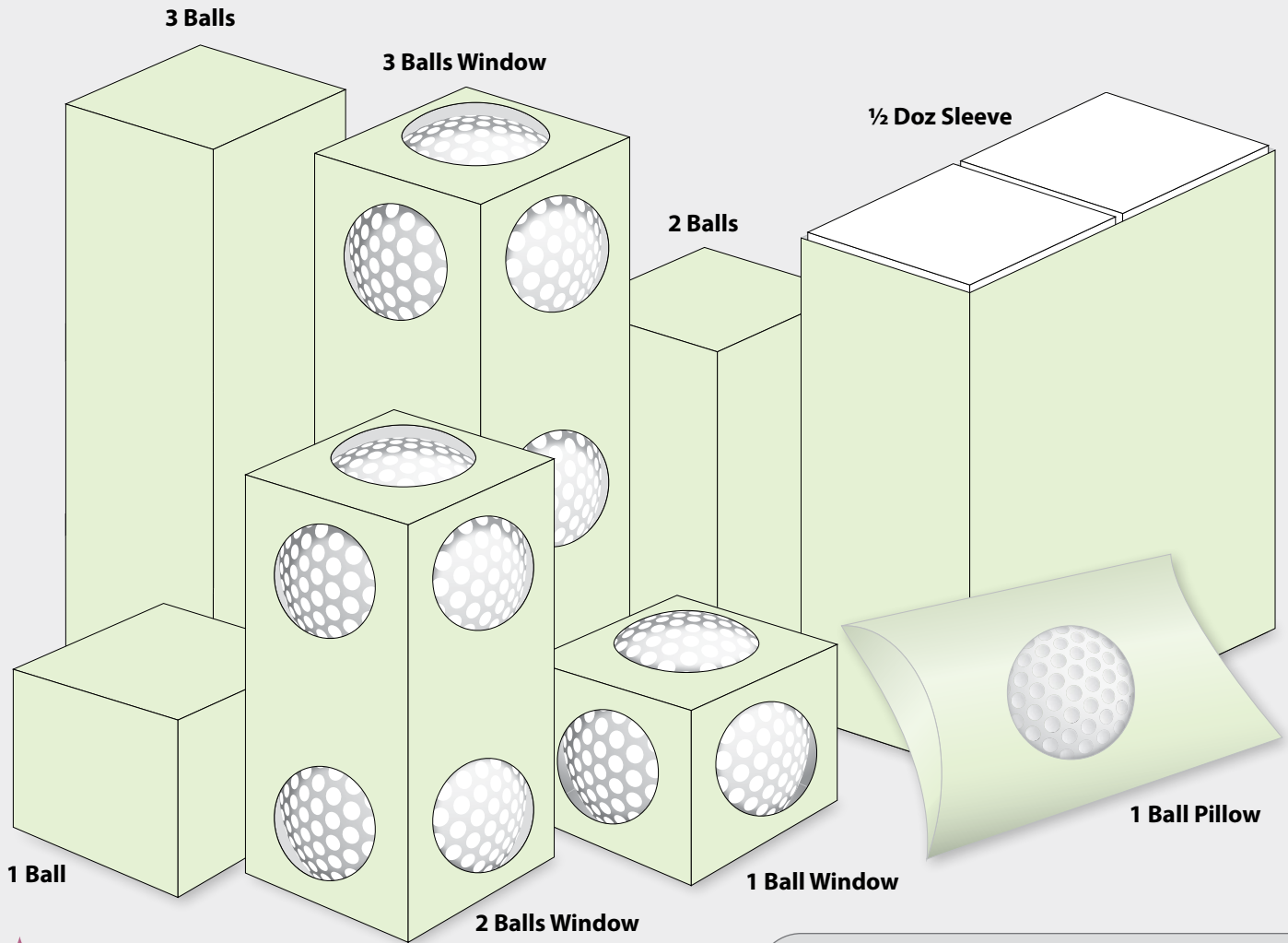

1 Ball

3 Balls Window

1/2 Doz Sleeve

2 Balls

1 Ball Pillow

2 Balls Window

1 Ball Window



16C

Specifications

Full Color Golf Ball Boxes on Coated Stock.

- Free Setup / Art / Logos
- Bleeds Allowed on All Sides
- No Die Charge on Standard Sizes
- No Overrun Charge
- Available in One Thickness
- Available in Nine Standard Boxes
- Made in USA

Material

U3030~U3038 : 11.4 pt Gloss Cover

Printing

Digital : Full Color Printing on One Side

Custom Size

No Custom Size

Option

No Print Sample : \$40.00 (G) for 2 pcs / dieline

Artwork Change : \$67.00 (G) each

* Box Only : No Ball Included

ITEM NO 50 100 150 200 250 300 350 400

U3030	1 Ball Pillow	6.15	4.20	3.56	3.23	3.04	2.91	2.82	2.75
U3031	1 Ball	6.73	4.44	3.68	3.31	3.08	2.93	2.82	2.74
U3032	1 Ball Window	6.81	4.53	3.77	3.39	3.16	3.01	2.90	2.82
U3033	2 Balls	7.12	4.84	4.08	3.70	3.48	3.32	3.22	3.13
U3034	2 Balls Window	7.30	5.02	4.26	3.88	3.65	3.50	3.39	3.31
U3035	3 Balls	7.87	5.59	4.83	4.45	4.22	4.07	3.96	3.88
U3036	3 Balls Window	8.13	5.85	5.09	4.71	4.48	4.33	4.22	4.14
U3037	1/2 Doz Sleeve	6.93	4.65	3.89	3.51	3.29	3.13	3.03	2.94
U3038	Dozen Sleeve	7.49	5.21	4.45	4.07	3.85	3.69	3.59	3.50

ITEM NO 500 750 1000 1500 2500 5000 7500 10000

U3030	1 Ball Pillow	2.65	2.35	2.01	1.43	0.99	0.68	0.57	0.52
U3031	1 Ball	2.62	2.30	2.04	1.46	1.01	0.68	0.58	0.52
U3032	1 Ball Window	2.71	2.39	2.04	1.46	1.01	0.68	0.58	0.52
U3033	2 Balls	3.02	2.70	2.14	1.55	1.10	0.78	0.67	0.62
U3034	2 Balls Window	3.19	2.72	2.14	1.55	1.10	0.78	0.67	0.62
U3035	3 Balls	3.77	2.91	2.33	1.75	1.30	0.98	0.87	0.82
U3036	3 Balls Window	4.03	2.91	2.33	1.75	1.30	0.98	0.87	0.82
U3037	1/2 Doz Sleeve	2.83	2.51	2.14	1.55	1.10	0.78	0.67	0.62
U3038	Dozen Sleeve	3.39	2.91	2.33	1.75	1.30	0.98	0.87	0.82

GOLF TEE PACKS



Package Size

2 1/8" Tee 2 5/8" x 2 1/2" x 1/2"

2 3/4" Tee 2 5/8" x 3" x 1/2"

3 1/4" Tee 2 5/8" x 3 7/16" x 1/2"

Specifications

Full Color Custom Printed Golf Tee Packs on Golf Tees.

- Free Setup / Art / Logos
- Bleeds Allowed on All Sides
- No Die Charge on Standard Sizes
- No Overrun Charge
- Available in One Thickness
- Pack Comes with Four White Golf Tees
- Available in Three Standard Tee Lengths
- Made in USA

Material

U3050~U3052 : 11.4 pt Gloss Cover

Printing

Digital : Full Color Printing on One Side

Golf Tees

White Tees Only Available in Three Lengths

Option

No Print Sample : \$40.00 (G) for 2 pcs / dieline

Artwork Change : \$67.00 (G) each



DIGITAL

16C

ITEM NO		50	100	150	200	250	300	350	400
U3050	2 1/8" Tee	5.05	3.60	3.12	2.88	2.73	2.64	2.57	2.52
U3051	2 3/4" Tee	5.10	3.65	3.16	2.92	2.78	2.68	2.61	2.56
U3052	3 1/4" Tee	5.14	3.69	3.21	2.96	2.82	2.72	2.65	2.60
ITEM NO		500	750	1000	1500	2500	5000	7500	10000
U3050	2 1/8" Tee	2.44	2.35	2.30	1.95	1.54	1.23	1.13	1.08
U3051	2 3/4" Tee	2.49	2.39	2.35	1.95	1.54	1.23	1.13	1.08
U3052	3 1/4" Tee	2.53	2.43	2.39	1.95	1.54	1.23	1.13	1.08

kit POCKET CADDY™



(3) Golf Tees



(2) Adhesive Bandages



(1) Insect Repellent



(2) Hand Wipes



(1) Sunscreen Lotion



(1) Insect Bite Relief Wipe



(1) Antimicrobial Wipe

U3060 Pocket Caddy™

2 1/2" x 3 7/8" x 3/4" (Package)

Kit includes eleven essential golfer's survival items

Specifications

Ultimate Golfer's Survival Kit in Custom Printed Full Color Gift Box.

- Free Setup / Art / Logos
- Bleeds Allowed on All Sides
- Package Printed in USA

Material

U3060 : 12.5 pt Gloss Cover

Kit Includes

(3) Golf Tees (2) Adhesive Bandages (1) Sunscreen Lotion (1) Sting Relief Medicated Wipe (1) Hand Sanitizing Wipe (1) Insect Repellent (2) Hand Wipe (11 items total)

Printing

Digital : Full Color Printing on One Side

Die Cutting

No Charge for Standard Package Shape
No Custom Shape is Available

Option

Artwork Change : \$67.00 (G) each

DIGITAL

6C

ITEM NO	250	500	1000	2500	5000	10000
U3060 Pocket Caddy™	5.26	4.74	4.09	3.70	3.54	3.35

JUST IN CASE™ edc

U3070~3072

5" x 1 3/8" (Label)

3 1/16" x 2 9/32" x 3/4" (Tin Can)

Various Net Wt.

U3070 EDC (15 items total)

- (3) Hand Sanitizer Gels
- (2) Adhesive Bandages
- (2) Antimicrobial Hand Wipes
- (2) Lens Cleaner Wipes
- (1) Lip Balm
- (1) Ibuprofen
- (1) Nail Clipper
- (1) Dental Floss
- (1) Safety Pin
- (1) Paper Clip



U3071 First Aid (17 items total)

- (3) Adhesive Bandages
- (2) Antimicrobial Hand Wipes
- (2) Alcohol Pads
- (2) Gauze Pads
- (1) Triple Antibiotic Ointment
- (1) Insect Repellent
- (1) Insect Bite Relief
- (1) Finger Bandage
- (1) Butterfly Bandage
- (1) Knuckle Bandage
- (1) Acetaminophen
- (1) Ibuprofen



U3072 Women's (13 items total)

- (2) Adhesive Bandages
- (2) Antimicrobial Hand Wipes
- (2) Hand Sanitizer Gels
- (1) Nail Clipper
- (1) Feminine Wipe
- (1) Sewing Kit
- (1) Bobby Pin
- (1) Dental Floss
- (1) Daily Liner
- (1) Hair Tie



Specifications

An assortment of everyday carry essentials with an emphasis on personal health, conveniently packaged in a durable tin case. You can modify the contents to your liking. An essential and useful kit for urban dwellers.

- Free Setup / Art / Logos
- Bleeds Allowed on All Sides
- Fresh Packed upon Receipt of Order
- High Quality, Durable, Tin Plated Steel Can
- Packaged in USA

Material

U3070~3972 : Bulk, Tin Case, Custom Gloss Label

Printing

Digital: Full Color Printing on One Side

Die Cutting

No Charge for Standard Shape

Custom Shape, add \$150.00 (G) each shape

Option

Artwork Change : \$67.00 (G) each



DIGITAL

6C

ITEM NO	100	250	500	1000	2500	5000
U3070~72 Just in Case™	13.06	11.71	11.25	11.02	10.88	10.84

BOTTLE CLEANING TABLETS

Fizz-Off Bottle Cleaning Tablet

No scrubbing

Removes stains and odors

Works great on plastic, stainless steel, glass, porcelain, & silicone



AFTER

BEFORE



Bottle Cleaning Tablet



Package 3 1/2" x 2 1/2"

Instructions for use



Fill the bottle or container with warm water & drop in one tablet.



Let it sit for 15-30 minutes while the fizz cleans the reservoir.

For stubborn stains, use hot water & let it sit overnight.



Empty the bottle, rinse thoroughly & your bottle is ready to be used again!



Specifications

Give your tumblers and bottles a new and fresh look with our new biodegradable and chlorine-free cleaning tablet! Our bottle cleaning tablets dissolve in water, creating bubbles that clean stubborn stains and odors without any harsh chemicals.

- Free Setup / Art / Logos
- Bleeds Allowed on All Sides
- Individually Packaged Tablet
- Packaged in USA

Material

Package : 8 pt Gloss Cover

Printing

Digital: Full Color Printing on One Side

Die Cutting

No Charge for Standard Shape

Custom Shape, add \$150.00 (G) each shape

Option

Artwork Change : \$67.00 (G) each

Packaging : Bulk

DIGITAL

6C

ITEM NO		100	250	500	1000	2500	5000
U3080	Bottle Cleaner	5.26	3.89	2.76	2.12	1.73	1.60

LEATHER hand crafted



Vegetable Tanned Leather : Why it matters?

- Leather is thick and hard wearing
- All materials are biodegradable
- Natural feel and rich earthy aroma
- Develops a rich and beautiful patina with use and age
- Feels more organic
- Takes on a unique wear pattern as you use it
- Each piece is unique with slight variations in color
- Leather hide that is conditioned but not treated.



U3110 Pencil Case

7 1/2" x 2 1/2" x 1 1/2" • Button Stud Closure

A great way to store pen & pencils, cosmetics, small tools, art supplies and more

U3111 Mouse Pad

9" x 9" / 1/8" thick

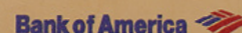

The thick leather provides a cushion for your hand and a smooth surface for your mouse.



U3114 Business Card Holder B

4" x 2 1/2" x 1" • Tuck-in Closure

More stylish, tuck-in closure, designed to keep your cards and cash organized.



U3113 Business Card Holder A

4" x 2 1/2" x 1" • Button Stud Closure

The simple, button stud closure is designed to keep your cards and cash organized.

U3112 Earphone Holder

3" x 1 3/4" x 1 3/4" • Button Stud Closure

Elegant holder for your earphones, so your cords stay clean and clear.



Specifications

Hand crafted from vegetable tanned leather that only gets better with age, accented with solid brass hardware, our leather goods are destined to become a longstanding part of your business day. Our leather goods are crafted with purpose and designed for functionality here in the heart of Long Island, NY. These make great gifts for anyone who appreciates quality daily usable goods made in the USA.

- Free Setup / Art / Logos / No Running Charge
- Unlined Interior
- Logo Printed in USA
- Hand Crafted in USA

Material

Full Grain Vegetable Tanned Leather & Solid Brass Hardware

Printing

Inkjet : Full Color Printing on One Location

Die Cutting

No Charge for Standard Shape

Option

Artwork Change : \$67.00 (G) each

ITEM NO		10	25	50	100	250	500
U3110	Pencil Case	40.58	39.02	37.52	36.07	35.02	34.00
U3111	Mouse Pad	26.65	25.63	24.64	23.69	23.00	22.33
U3112	Earphone Holder	10.12	9.73	9.36	9.00	8.74	8.48
U3113	Card Holder A	22.32	21.46	20.63	19.84	19.26	18.70
U3114	Card Holder B	21.76	20.93	20.12	19.35	18.78	18.24



hand crafted LEATHER



U3115 Valet Tray Large
8 1/2" x 7" x 1"



U3117 Valet Tray Small
4" x 4" x 1"



U3116 Valet Tray Medium
8 1/2" x 4" x 1"



U3125 Pen Holder
1 3/8" x 1 1/8" x 3/4"

Handcrafted from solid oak wood, our Pen Holder is a minimal yet stylish desktop accessory to keep your pen within easy reach.

U3124 Pen Tray
8" x 2 1/2" x 5/8"

Handcrafted from solid oak wood and accentuated with vegetable tanned leather, our Pen Tray is a simple yet stylish desktop accessory to keep your pens organized and within easy reach. Complete your desk with this all-natural yet minimalistic design accessory.

ITEM NO		10	25	50	100	250	500
U3115	Valet Tray Large	26.45	25.43	24.45	23.51	22.83	22.16
U3116	Valet Tray Medium	18.97	18.24	17.54	16.86	16.37	15.89
U3117	Valet Tray Small	13.15	12.64	12.16	11.69	11.35	11.02
U3124	Pen Tray	35.31	33.95	32.64	31.39	30.47	29.59
U3125	Pen Holder	7.64	7.35	7.07	6.80	6.60	6.41

LEATHER hand crafted

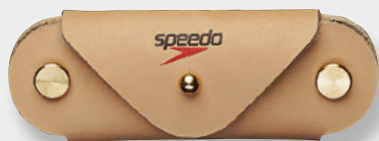

U3120 Key Holder
4" x 1 1/4" x 3/4" • Button Stud Closure

The key holder holds up to 6 common household keys that can either be secured, or swivel out at your convenience.



U3121 Belt Bag
8" x 3 1/2" x 1 1/8" • Button Stud Closure

This rectangular waist bag will be your favorite piece in busy days, pack your daily essentials in one place.

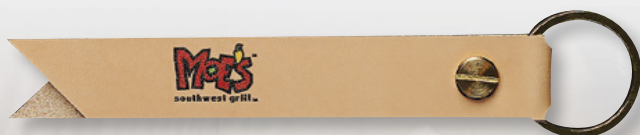

U3119 Key Chain
5 7/8" x 3/4" x 3/8"

The leather and brass will patina and age with use to create a keychain that is uniquely yours.



U3123 JUUL® Case
6" x 1 1/2" x 2" • Button Stud Closure

Are you tired of losing your Juul? Continuously looking for it in your pockets? These JUUL® holsters are just what you need. This conveniently clips to your belt loop, purse or backpack. The most convenient way to carry and protect your JUUL®. JUUL is a trademark of JUUL Labs, Inc.



U3122 Sunglasses Case
6 1/2" x 2 3/4" x 2" • Button Stud Closure

One large inside compartment for small reading glasses to large sunglasses.

		INKJET					
ITEM NO		10	25	50	100	250	500
U3119	Key Chain	10.32	9.93	9.54	9.18	8.91	8.65
U3120	Key Holder	14.54	13.98	13.44	12.92	12.55	12.18
U3121	Belt Bag	52.02	50.02	48.10	46.25	44.90	43.59
U3122	Sunglasses Case	32.17	30.93	29.74	28.60	27.76	26.96
U3123	JUUL® Case	26.55	25.53	24.55	23.60	22.91	22.25

DESK MATS / COASTERS

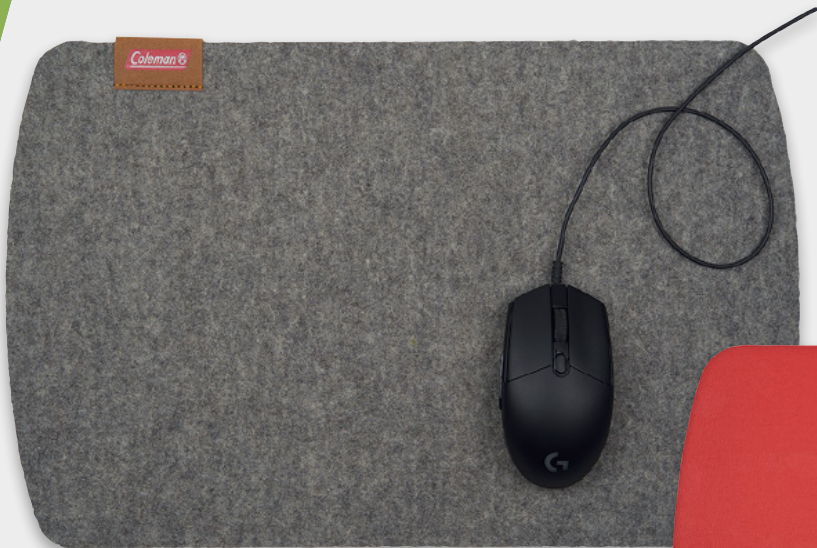

U3150 Desk Mat
Wool Felt, 17 1/2" x 11 1/2"



U3151 Desk Mat
PVC, 17 1/2" x 11 1/2"



U3160 Coaster
Wool Felt, 4" x 4"
Set of 4



U3161 Coaster
PVC, 4" x 4"
Set of 4

Desk Mats

Organize your desk space with a stylish and functional desk pad. Available in two materials, our desk mats are an essential piece to elevate your workspace.

Coasters

Our coasters are gentle to your surfaces and provide a gentle landing spot for your glass or cup. Will not cause damage like marble or stone if accidentally dropped.

Specifications

Full Color Custom Desk Mats and Coasters. Simply elegant modern cut to protect delicate surfaces from scratches, heat and moisture.

- Free Setup / Art / Logos
- Bleeds Not Allowed
- Anti-Bacterial (Felt - Naturally, PVC - from coating)
- Made in USA

Material

PVC : 32 oz / linear yd, Paper Backed, Mildew Resistant

Felt : 3mm Merino Wool Felt, Oeko Tex® 100 Certified Class II, EU Toy Safety Standard EN 71, Natural & Renewable

Printing

Digital : Full Color on Front (PVC), Front & Back (Felt)

Die Cutting

No Charge for Standard Shape

Custom Shape is Available, add

Custom Shape, add \$150.00 (G) each shape

Option

Artwork Change : \$67.00 (G) each

INKJET

6C

ITEM NO		10	25	50	100	250	500
U3150	Desk Mat - Felt	38.20	36.73	35.31	33.96	32.97	32.01
U3151	Desk Mat - PVC	32.38	31.14	29.94	28.79	27.95	27.13
U3160	Coaster - Felt	35.17	33.81	32.51	31.26	30.35	29.47
U3161	Coaster - PVC	17.93	17.24	16.57	15.94	15.47	15.02

COIN SET

Mint Set (1947 to Date)

The United States Uncirculated Coin Set, known as the Mint Set in the United States, is an annual coin set sold by the United States Mint. The set is marketed towards coin collectors as a way to obtain circulation coins in mint condition.

Proof Set (1936 to Date)

Proof Set is a set of proof coins sold by the United States Mint. The proof set is popular with coin collectors as it is an affordable way to collect examples of United States coinage in proof condition.

Silver Proof Set (1976, 1992 to Date)

The Silver Proof set containing a dime, quarter, and half dollar composed of 90% silver. The compositions for the penny, nickel, and dollar remained the same as in the standard proof sets.



U3180 Wood Frame 5" x 7"



U3186 Single Coin
2" x 2"



U3185 Mint Set
2" x 6"

Specifications

Full Color Custom Packed Coin Gift. Whether you're looking to celebrate a milestone or anniversary, honor a person, or welcome a new business opportunity, a coin from U.S. Mint makes any moment an occasion to remember.

- Free Setup / Art / Logos
- Bleeds Allowed on All Sides
- Made in USA

Material

U3180 : Real Wood Frame, 3/16" Foamcore Insert
U3185/6 : Coin Holder, 80# Gloss Cover Insert

Printing

Digital : Full Color Printing on Insert

Die Cutting

No Charge for Standard Insert Shape
Custom Shape is Available for U3180, add
Custom Shape, add \$150.00 (G) each shape

Option

Artwork Change : \$67.00 (G) each



Pricing not include coins. Coin price extra.

6C

ITEM NO		100	250	500	1000	2500	5000
U3180	5"x7" Frame	22.53	22.03	21.87	21.78	21.73	21.72
ITEM NO		100	250	500	1000	2500	5000
U3185	Mint Set	8.71	7.26	6.78	6.54	6.39	6.34
U3186	Single Coin	5.39	3.94	3.46	3.21	3.06	3.01

notepads NOTABLE™

U3213
3" x 4"

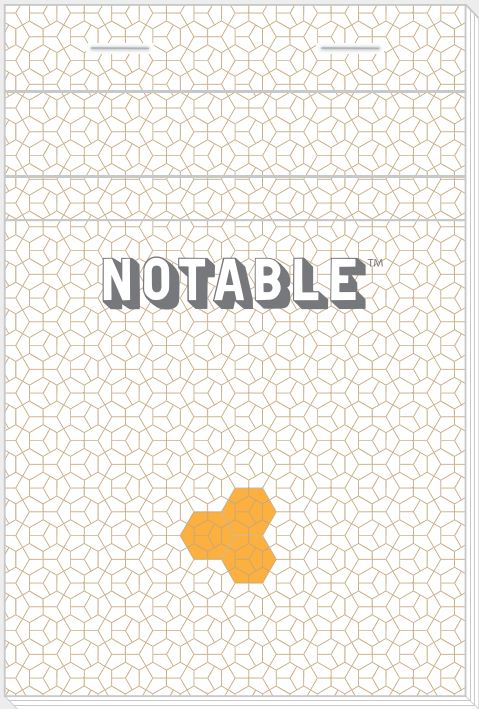
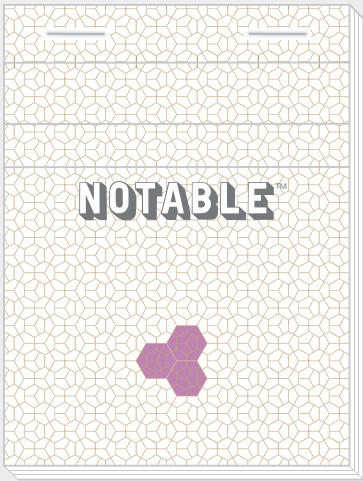

U3215
4" x 6"

U3214
3 1/2" x 5 1/2"

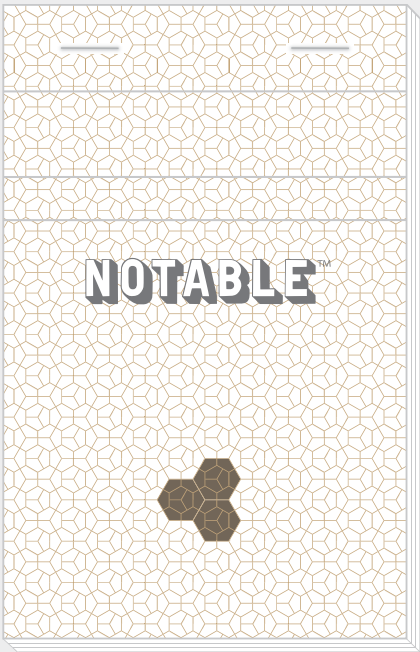

STANDARD INSIDE

Blank

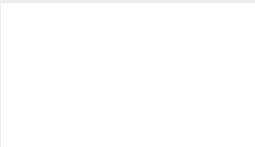

Ruled

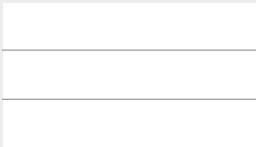

Graph

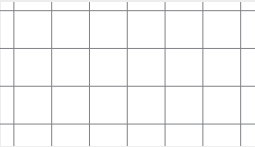

Dotted



U3217
5 1/2" x 8 1/2"

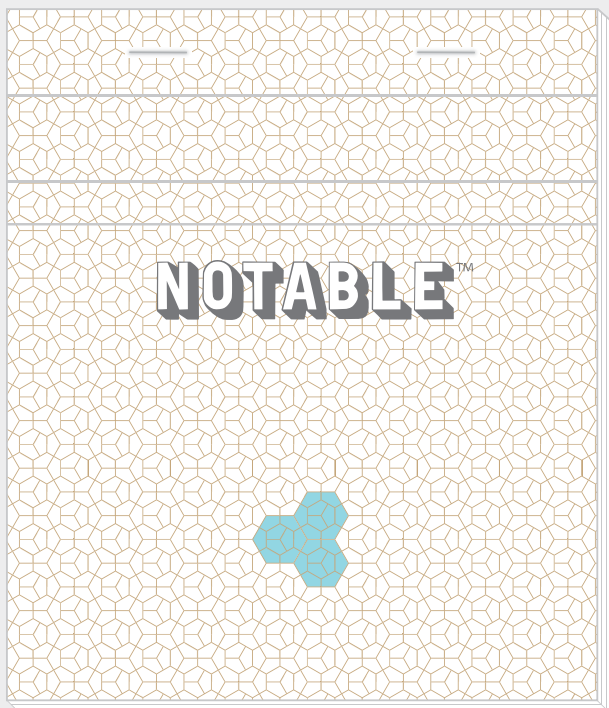
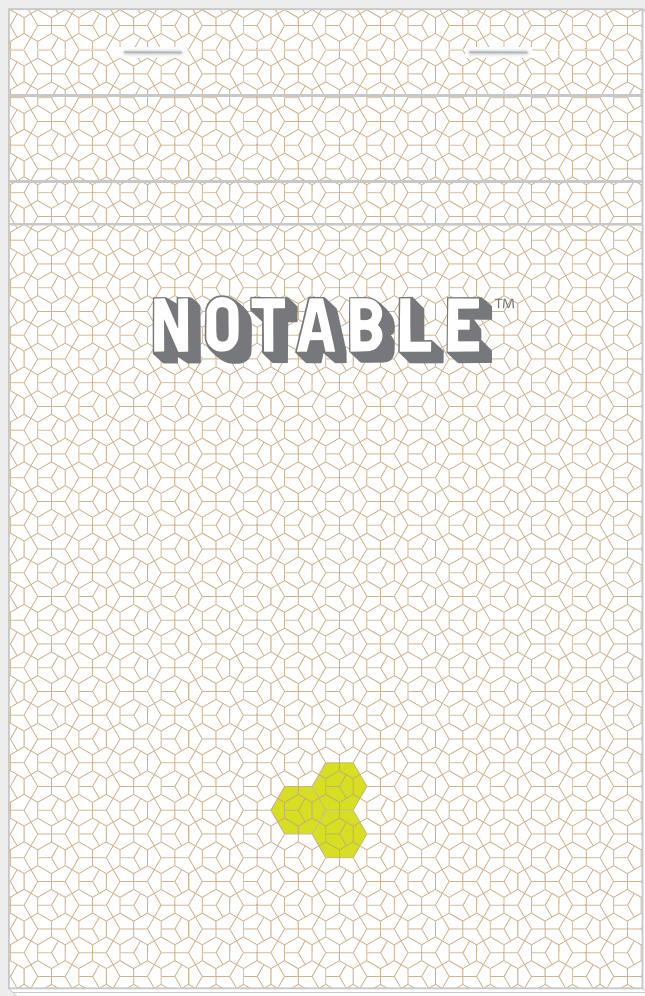

U3216
5 1/8" x 6"

Specifications

Custom Printed Full Color Cover and One PMS Color inside with fountain pen friendly papers. Our paper ensures a better note keeping experience as most pens glide across the surface smoothly without snagging and with minimized feathers and bleeds.

- Free Setup / Art / Logos
- Bleeds Allowed on All Sides for Cover
- 80 Sheets per Pad with Flip Over Cover
- Cardboard Backed
- Micro-perforated Sheets for Easy Tear
- Available in Five Popular Sizes
- Made in USA

Material

Cover : 11.4 pt Gloss Cover
Inside : 60# Opaque Text

Printing

Cover : Full Color Printing on Two Sides (Digital)
Inside : One PMS Color Printing on Two Sides (Offset)

Option

Artwork Change : \$67.00 (G) each



16C

ITEM NO		50	100	150	200	250	300	350	400
U3213	3" x 4"	8.85	6.10	5.18	4.72	4.45	4.26	4.13	4.03
U3214	3 1/2" x 5 1/2"	9.90	7.15	6.23	5.78	5.50	5.32	5.19	5.09
U3215	4" x 6"	11.33	8.58	7.67	7.21	6.94	6.76	6.63	6.53
U3216	5 1/8" x 6"	12.02	9.27	8.36	7.90	7.63	7.44	7.31	7.21
U3217	5 1/2" x 8 1/2"	13.39	10.65	9.73	9.28	9.00	8.82	8.69	8.59
ITEM NO		500	750	1000	1500	2500	5000	7500	10000
U3213	3" x 4"	3.90	3.74	3.64	3.55	3.31	2.95	2.80	2.72
U3214	3 1/2" x 5 1/2"	4.95	4.79	4.70	4.45	3.95	3.50	3.36	3.28
U3215	4" x 6"	6.39	6.23	5.71	4.96	4.37	3.92	3.77	3.70
U3216	5 1/8" x 6"	7.08	6.61	6.05	5.31	4.71	4.26	4.12	4.04
U3217	5 1/2" x 8 1/2"	8.28	7.65	7.10	6.35	5.76	5.31	5.16	5.08

notebooks NOTABLE™

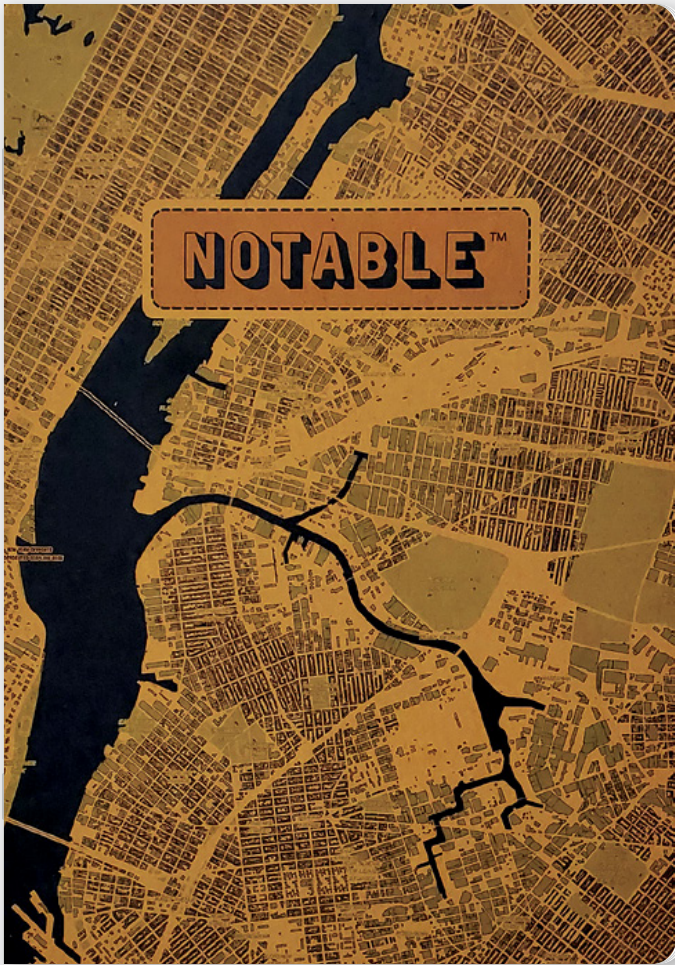

U3227 7" x 10"
Kraft Cover

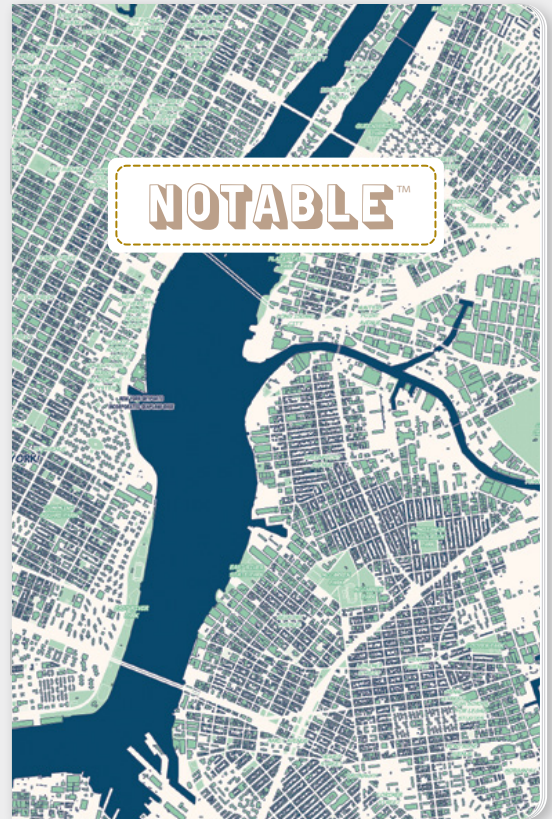

U3226 5 ½" x 8 ½"
White Cover

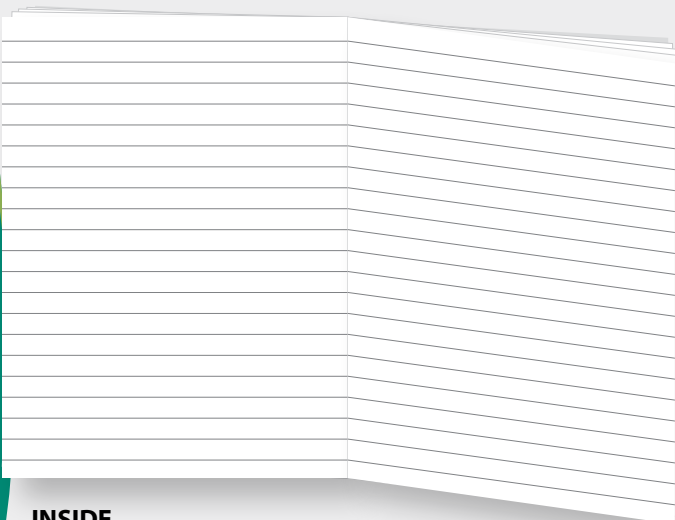

INSIDE



U3225 5" x 7"
Pearlized White Cover

Standard Cover

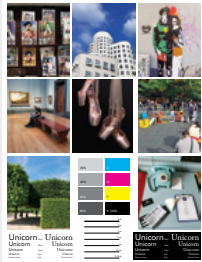
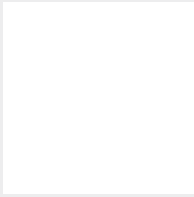

White
Ultra Smooth Finish

Extra Option Cover

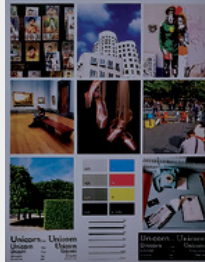

Gray
Smooth Finish

Extra Option Cover



Desert
Smooth Finish

Extra Option Cover



Kraft
Raw Finish

Extra Option Cover

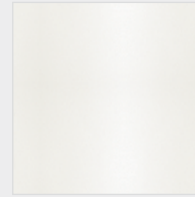

Pearlized White
Smooth Finish

G

COVER OPTION ADD

5" x 7"	0.60
5 1/2" x 8 1/2"	0.60
7" x 10"	0.60

STANDARD INSIDE

Blank

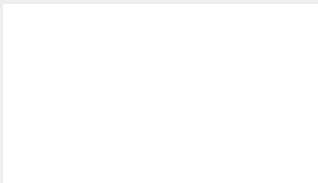

Ruled

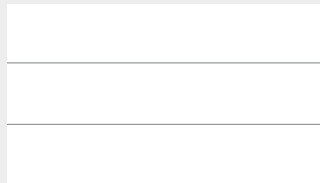

Graph

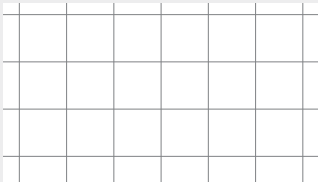

Dotted



Specifications

Custom Printed Notebooks with Full Color Cover and One PMS Color inside with fountain pen friendly papers for a better note keeping experience.

- Free Setup / Art / Logos
- Bleeds Allowed on All Sides
- Available in Five Cover Options
- Available in Three Popular Sizes
- Made in USA

Material

Cover : 100# Uncoated Cover

Inside : 60# Opaque Text (12 Sheets / 48 Pages)

Cover Stock Option

White Ultra Smooth : Full Color Printed Cover (Standard)

Other Covers : Add Extra Option Charge to the Base Price

Printing

Cover : Full Color Printing on One Side (Digital)

Inside : PMS One Color Printing on Two Sides (Offset)

Option

Artwork Change : \$67.00 (G) each



DIGITAL COVER

16C

ITEM NO		50	100	150	200	250	300	350	400
U3225	5" x 7"	9.86	7.11	6.20	5.74	5.47	5.08	4.75	4.51
U3226	5 1/2" x 8 1/2"	9.86	7.11	6.20	5.74	5.47	5.08	4.75	4.51
U3227	7" x 10"	11.04	8.30	7.38	6.93	6.65	6.26	5.94	5.70
ITEM NO		500	750	1000	1500	2500	5000	7500	10000
U3225	5" x 7"	4.17	3.74	3.51	3.16	2.79	2.52	2.43	2.38
U3226	5 1/2" x 8 1/2"	4.17	3.74	3.51	3.28	2.92	2.64	2.55	2.50
U3227	7" x 10"	5.36	4.92	4.68	4.23	3.87	3.59	3.51	3.46

desk planners NOTABLE™



U3280
12" x 8"

STANDARD ARTWORK

Monthly Plan

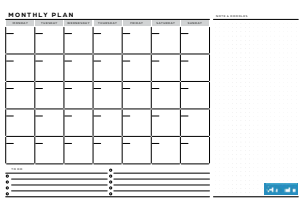

Project Planner

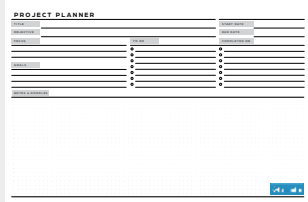

Weekly Plan

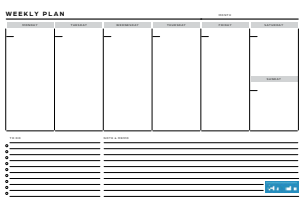

Specifications

Custom Printed Desk Planners with Full Color Artwork with fountain pen friendly papers for a better note keeping experience. Unlike traditional calendars, our planner is undated so you can fill in the date on your own — perfect for using during those busy days where you need an extra hand staying organized.

- Free Setup / Art / Logos
- Bleeds Allowed on All Sides
- 24 pt Cardboard Backing
- Glue Padded on the Top
- Made in USA

Material
Planner : 60# Opaque Text (12 Sheets)

Printing
Digital : Full Color Printing on One Side

Option
Artwork Change : \$67.00 (G) each

ITEM NO		50	100	150	200	250	300	350	400
U3280	12" x 18"	14.08	9.08	7.41	6.58	6.08	5.74	5.09	4.60
ITEM NO		500	750	1000	1500	2500	5000	7500	10000
U3280	12" x 18"	3.92	3.04	2.58	2.13	1.77	1.50	1.41	1.36

NOTABLE™ wool felt memo

This felt memo are crafted from luxurious Merino Wool Felt, making them both stylish and functional. Made of high grade paper, our memo is perfect for jotting down impromptu notes, observations, and ideas.

U3281

3" x 4 1/2" (Memo)
5 1/8" x 3 3/8" x 1 7/8" (Tray)



Specifications

Custom Printed Memo with Full Color Artwork with Wool Felt Tray. This felt memo are crafted from luxurious Merino Wool Felt, making them both stylish and functional. Made of high grade paper, our memo is perfect for jotting down impromptu notes, observations, and ideas.

- Free Setup / Art / Logos
- Bleeds 10% Extra
- Made in USA

Material

Memo : 60# Opaque Text (250 Sheets)

Tray : 3mm Merino Wool Felt

- Oeko Tex® 100 Certified Class II
- EU Toy Safety Standard EN 71
- Natural & Renewable
- Naturally Anti-Bacterial

Printing

Digital : Full Color Printing on One Side (Memo)

Option

Artwork Change : \$67.00 (G) each

ITEM NO		DIGITAL					
		10	25	50	100	250	500
U3281	Felt Memo	21.49	20.66	19.87	19.11	18.55	18.01

100% Handmade
in USA

TYVEK[®] POUCHES



U3410
11 ¼" x 8 ½"



U3411
8 ½" x 5 ½"



U3412
5 ½" x 5 ½"

Specifications

Made from lightweight, water-resistant, and 100% recyclable Tyvek[®], our durable multi-function zipper Tyvek[®] Pouch can protect your belongings from virtually any situation. It is available in three different sizes and can be custom printed to suit any purpose.

- Free Setup / Art / Logos
- Bleeds Allowed on All Sides
- Lightweight, Water-resistant, and 100% Recyclable
- Available in Three Sizes
- Made in USA

Material

U3410~3412 : Bulk, Tyvek[®]

Printing

Digital: Full Color Printing on Two Sides

Die Cutting

No Charge for Standard Shape

Custom Shape, add \$150.00 (G) each shape

Option

Artwork Change : \$67.00 (G) each

DIGITAL

6C

ITEM NO		96	240	480	960	2400	4800
U3410	11 ¼" x 8 ½"	16.58	15.91	15.69	15.57	15.04	14.47
U3411	8 ½" x 5 ½"	11.39	10.73	10.51	10.40	10.33	10.08
U3412	5 ½" x 5 ½"	9.56	8.90	8.67	8.55	8.49	8.46

GIFT SETS *kraft*



2 oz Glass Tray

can be combined with any combination of candles/salts/spices/teas/floral teas



2.5" Tin Can Tray

can be combined with any combination of salts/spices/teas/floral teas



Essential Oils Tray



Roll-ons Tray



Tissue Paper Pink

Specify color



Crinkle Paper Black

Specify color



Crinkle Paper White

Specify color



Tissue Paper Yellow

Specify color

U3520 6 Pack Gift Set

8" x 6 1/4" x 2" (Gift Box)

3 3/4" x 5 3/4" (Label)



U3500 3 Pack Gift Set

6 29/32" x 2 7/32" x 2 3/32" (Gift Box for Glass)

6" x 2" x 2 5/8" (Gift Box for Tin)

5 1/2" x 1 3/4" (Label)



Specifications

Custom packaged gift set box with a choice of three or six items included. Made from high-end, eco-friendly kraft corrugated materials, plus a custom printed tray or tissue paper, a custom printed label to seal the box. Gift box can be used as a mailer.

- Free Setup / Art / Logos
- Bleeds Allowed on All Sides on Label and Tray
- Printed and Packaged in USA

Material

Package : Gift Box (200# E-flute Kraft Corrugated), Custom Gloss Label, Custom Tray (16pt Cover Stock) or Tissue Paper

Printing

Digital : Full Color Printing on Label & Tray

Die Cutting

No Charge for Standard Tray Shape

Custom Tray Shape, add \$150.00 (G) each shape

Option

Artwork Change : \$67.00 (G) each

Crinkle Paper Fill : \$2.00 (G) each box (min.)

Customer Supplied Items (G)

Setup Change : \$65.00 each per packout

Product Picking : \$0.50 (S) \$1.50 (M) \$3.00 (L)

Printed Marketing Material : \$0.20



DIGITAL

BOX & PACKING ONLY PRICE

7C

ITEM NO		48	96	240	480	960	2400	4800
U3500	3 Pack Gift Set	5.67	3.91	2.85	2.49	2.32	2.21	2.17
U3520	6 Pack Gift Set	11.14	7.87	5.92	5.26	4.90	4.21	3.98

5 dram GIFT SETS



U3540~3547
 3" x 1" (Label)
 1" x 2 1/2" (Bottle)
 8" x 2 1/16" x 1 1/2" (Gift Box)
 Various Net Wt.



Specifications

With its eye-catching vial design made from slim glass topped with a natural cork, this 5/8 ounce vial is an ideal container for teas, herbs, spices, and seasonings. Comes in sets of six vials packaged in a custom printed gift box for any occasion.

- Free Setup / Art / Logos
- Bleeds Allowed on All Sides on Label and Box
- Six Set Custom Printed Gift Box
- High Quality, Food Grade, Durable, Vial with Cork Lid
- Fresh Packed upon Receipt of Order in USA

Material

Package : Gift Box (111# Gloss Cover), Custom Gloss Label

Printing

Digital : Full Color Printing on Box & Label, No Print on Tray

Die Cutting

No Charge for Standard Shape

Custom Shape, add \$150.00 (G) each shape

Option

Artwork Change : \$67.00 (G) each

AVAILABLE with

Salts page 29
Spices & Herbs page 30
Seasonings page 31

Peppercorns page 32
Chili Peppers page 33
Teas page 34
Sprouting Seeds page 39

DIGITAL

7C

ITEM NO		48	96	240	480	960	2400	4800
U3540	Salts	32.74	27.71	24.73	23.69	22.62	21.44	21.04
U3541	Infused Salts	34.74	29.71	26.73	25.69	24.62	23.44	23.04
U3542	Spices & Herbs	30.07	25.04	22.06	21.02	19.95	18.77	18.38
U3543	Seasonings	30.74	25.71	22.73	21.69	20.62	19.44	19.04
U3544	Peppercorns	31.40	26.37	23.40	22.35	21.29	20.10	19.71
U3545	Chili Peppers	30.74	25.71	22.73	21.69	20.62	19.44	19.04
U3546	Teas	30.74	25.71	22.73	21.69	20.62	19.44	19.04
U3547	Sprouting Seeds	33.40	28.37	25.40	24.35	23.29	22.10	21.71

GIFT SET hexagon™



U3560~3579 except U3562

4" x 1/2" (Top Label)
 6 5/8" x 4 3/8" (Side Label)
 1 25/32" x 1 25/32" x 2 1/2" (Tin Can)
 12 1/2" x 3 21/32" x 3 1/4" (Gift Box)

Various Net Wt.

U3562 Candles

2 17/32" x 1" (Label)
 2 3/16" x 2" (Glass Jar)
 12 1/2" x 3 21/32" x 3 1/4" (Gift Box)

Net Wt. 1.5 oz

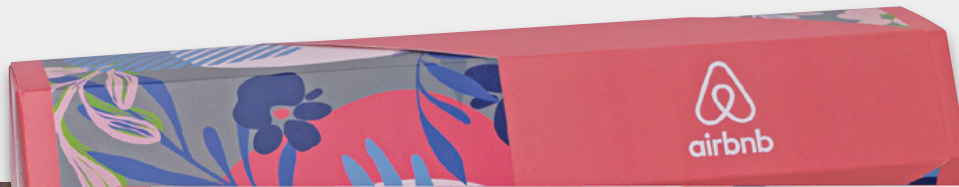

AVAILABLE as 6 tin can set

Essential Oils page 7
 Roll-ons page 8
 Salts page 29
 Spices & Herbs page 30
 Seasonings page 31
 Peppercorns page 32
 Chili Peppers page 33

Teas page 34
 Floral Teas page 35
 Superfood Powder page 36
 Protein Powders page 37
 Sprouting Seeds page 39
AVAILABLE as 5 glass jar set
 Candles page 11

Specifications

Packed fresh upon order in our sealed facility, our Hexagon™ food-grade tins keep its contents fresh. Comes in a variety of different collections complete with custom labels, an elegant custom printed box. Our Hexagon™ Gift Set is a premium gift for any occasion.

- Free Setup / Art / Logos
- Bleeds Allowed on All Sides on Label and Box
- High Quality, Food Grade, Durable, Tin Plated Steel Can
- Only Candles Packed Five in Recyclable Glass Jar
- Fresh Packed upon Receipt of Order in USA

Material

Package : Gift Box (111# Gloss Cover), Custom Gloss Label

Printing

Digital : Full Color Printing on Box, Sleeve, and Label

Die Cutting

No Charge for Standard Shape

Custom Shape, add \$600.00 (G) each shape

Option

Artwork Change : \$67.00 (G) each



ITEM NO		48	96	240	480	960	2400	4800
U3560	Essential Oils	75.77	68.33	63.87	61.66	59.94	58.19	57.45
U3561	Roll-ons	74.43	67.00	62.54	60.32	58.61	56.85	56.11
U3562	Candles	76.85	69.42	64.96	62.74	61.03	59.27	58.53
U3570	Salts	87.84	80.41	75.95	73.73	72.02	70.27	69.26
U3571	Spices & Herbs	70.18	62.74	58.28	56.07	54.35	52.60	51.59
U3572	Seasonings	72.18	64.74	60.28	58.07	56.35	54.60	53.59
U3573	Peppercorns	80.84	73.41	68.95	66.73	65.02	63.27	62.26
U3574	Chili Peppers	72.18	64.74	60.28	58.07	56.35	54.60	53.59
U3575	Teas	74.18	66.74	62.28	60.07	58.35	56.60	55.59
U3576	Floral Teas	70.84	63.41	58.95	56.73	55.02	53.27	52.26
U3577	Superfood Powder	74.18	66.74	62.28	60.07	58.35	56.60	55.59
U3578	Protein Powder	77.51	70.08	65.62	63.40	61.69	59.93	58.92
U3579	Sprouting Seeds	94.51	87.08	82.62	80.40	78.69	76.93	75.92

salt & pepper GIFT SETS

Specifications

Offered as a set in 10ml mini glass grinder bottles, our Salt & Pepper Mini Grinder Set is the ideal gift for the cooks and chefs in our lives. Our mini grinder comes with a glass bottle, a plastic grinder, and a cap to seal the container and maintain the freshness of the product inside.

- Free Setup / Art / Logos
- Bleeds Allowed on All Sides
- Set of Two 10ml Mini Glass Grinder Bottles in Custom Box
- Fresh Packed upon Receipt of Order in USA

Material

Package : Bulk, Glass Grinder Set, Custom Gloss Label
Gift Box : 111# Gloss Cover

Printing

Digital : Full Color Printing on the Label

Die Cutting

No Charge for Standard Shape

Custom Shape, add \$150.00 (G) each shape

Option

Artwork Change : \$67.00 (G) each

Salt & Pepper Mini Grinder Set

Mini Portable Size

Perfect For School, Office, Lunch Box, Camping

Himalayan Pink

Our Himalayan Pink is the highest quality salt of its kind. The beautiful pink color and rich variety of trace minerals is the ideal option for any day.

Black Peppercorns

Black peppercorns are left on the vine to fully mature, then are picked and dried in the sun or blanched before drying. They have a strong spicy flavor due to the presence of the chemical piperine and varying amounts of essential oil.



U3590

2 ¼" x 1 ⅛" (Label)

1 ⅛" x 2 ⅞" (Bottle)

2 ¼" x 1 ⅛" x 2 ¾" (Gift Box)

Net Wt. 0.3 (pepper) & 0.6 oz(salt) with full-color custom graphics

		DIGITAL						7C
ITEM NO		48	96	240	480	960	2400	4800
U3590	Salt & Pepper	24.48	19.45	16.43	15.40	14.47	13.91	13.64



SALTS

All-natural Gourmet Salts

Himalayan Pink

Our Himalayan Pink is the highest quality salt of its kind. The beautiful pink color and rich variety of trace minerals is the ideal option for any day.

Hiwa Kai

Made with pure sea salt and activated charcoal derived from coconut shells, Hiwa Kai is an exotic, sultry sea salt reminiscent of the black beaches of Hawaii.

Alaea

Alaea Hawaiian-style red sea salt is an all-natural combination of pure sea salt and purified alae clay with a Hawaiian-inspired flair and a delicious flavor.

Flaky

Sea salt flakes are loved by chefs and foodies from all over the world. Packed with freshness, Flakes enhance the flavor of foods with none of the bitter aftertaste.

Sel Gris

Our most iconic artisanal salt, harvested by hand from clay-lined salt ponds in the Gu erande region of France. Sel Gris retains much of its natural moisture.

Alderwood

Alderwood Smoked Sea Salt is beloved for its campfire smoke taste and pairs perfectly with salmon, offering rich, bold, and smoky flavors without bitterness.



DIGITAL

6C

ITEM NO		96	240	480	960	2400	4800
U4001G	Himalayan Pink	12.17	10.77	10.29	10.05	9.91	9.86
U4002G	Hiwa Kai	13.17	11.77	11.29	11.05	10.91	10.86
U4003G	Alaea	13.17	11.77	11.29	11.05	10.91	10.86
U4004G	Flaky	13.17	11.77	11.29	11.05	10.91	10.86
U4005G	Sel Gris	13.17	11.77	11.29	11.05	10.91	10.86
U4006G	Alderwood	14.17	12.77	12.29	12.05	11.91	11.86
U3435G	Gift Box (option)	5.07	3.50	2.94	2.24	1.65	1.31
U4001T	Himalayan Pink	14.59	13.18	12.70	12.47	12.33	12.28
U4002T	Hiwa Kai	16.59	15.18	14.70	14.47	14.33	14.28
U4003T	Alaea	16.59	15.18	14.70	14.47	14.33	14.28
U4004T	Flaky	16.59	15.18	14.70	14.47	14.33	14.28
U4005T	Sel Gris	15.59	14.18	13.70	13.47	13.33	13.28
U4006T	Alderwood	17.59	16.18	15.70	15.47	15.33	15.28
U3435T	Gift Box (option)	5.07	3.50	2.94	2.24	1.65	1.31

U4001T~4006T

4" x 1/2" (Top Label)

6 5/8" x 1 27/32" (Side Label)

1 25/32" x 1 25/32" x 2 1/2" (Tin Can)

1 7/8" x 1 7/8" x 2 5/8" (Gift Box)

Various Net Wt.

Specifications

From sea salts from France, mineral salts from the Himalayas, to smoked salts created here in the USA, we ensure that our customers receive the highest quality salt available.

- Free Setup / Art / Logos
- Bleeds Allowed on All Sides
- Temper Proof Seal
- Elegant Wide Mouth, Easy Access Glass Jar with Black Lid
- High Quality, Food Grade, Durable, Tin Plated Steel Can
- Fresh Packed upon Receipt of Order in USA

Material

Package : Bulk, Glass Jar or Tin Can, Custom Gloss Label

Gift Box (option) : 111# Gloss Cover

Printing

Digital : Full Color Printing on the Label

Die Cutting

No Charge for Standard Shape

Custom Shape, add \$150.00 (G) each shape

Option

Artwork Change : \$67.00 (G) each



U3435G/3435T

Gift Box (option)

with full-color custom graphics

U4001G~4006G

1 3/8" diameter (Top Label)

7" x 7/8" (Side Label)

2 1/8" x 2" (Glass Jar)

2 3/16" x 2 3/16" x 2 1/8" (Gift Box)

Various Net Wt.

SPICES & HERBS

Sweet and Savory Spices & Herbs

Cinnamon

As a spice, cinnamon is available in powder form or whole, as pieces of bark. It is now the second most popular spice, after black pepper, in the United States and Europe. Cinnamon is used mainly as an aromatic condiment and flavoring additive in a wide variety of cuisines.

Cumin

Cumin is a spice made from the dried seed of a plant known as *Cuminum cyminum*. It is a typical ingredient in chili powder and is also often found in other spice blends such as garam masala, curry powder, and adobos.

Garlic

Garlic powder is a spice that is derived from dehydrated garlic and used in cooking for flavor enhancement. Garlic powder is a common component of spice mix. It is also a common component of seasoned salt.

Oregano

Dried oregano is the more common form, and some people prefer it because it is more subtle and doesn't overpower dishes as fresh oregano might. The taste is pungent and described as earthy and green. It adds strong flavor to a variety of savory foods.

Rosemary

Rosemary has a strong piney, resinous flavor and can easily take over a dish, so it should be used sparingly. This culinary herb is best known for its use in poultry dishes, soups, spreads, and teas.

Thyme

Thyme is often included in seasoning blends for poultry and stuffing and also commonly used in fish sauces, chowders, and soups. It goes well with lamb and veal as well as in eggs, custards, and croquettes.



ITEM NO		96	240	480	960	2400	4800
U4101G	Cinnamon	11.17	9.77	9.29	9.05	8.91	8.86
U4102G	Cumin	11.17	9.77	9.29	9.05	8.91	8.86
U4103G	Garlic	11.17	9.77	9.29	9.05	8.91	8.86
U4104G	Oregano	10.17	8.77	8.29	8.05	7.91	7.86
U4105G	Rosemary	10.17	8.77	8.29	8.05	7.91	7.86
U4106G	Thyme	10.17	8.77	8.29	8.05	7.91	7.86
U3435G	Gift Box (option)	5.07	3.50	2.94	2.24	1.65	1.31
U4101T	Cinnamon	13.59	12.18	11.70	11.47	11.33	11.28
U4102T	Cumin	12.59	11.18	10.70	10.47	10.33	10.28
U4103T	Garlic	12.59	11.18	10.70	10.47	10.33	10.28
U4104T	Oregano	12.59	11.18	10.70	10.47	10.33	10.28
U4105T	Rosemary	12.59	11.18	10.70	10.47	10.33	10.28
U4106T	Thyme	12.59	11.18	10.70	10.47	10.33	10.28
U3435T	Gift Box (option)	5.07	3.50	2.94	2.24	1.65	1.31

6C

Specifications

Spices are aromatic flavorings from seeds, fruits, and other plant parts. Spices differ from herbs, which are the leaves, flowers, or stems of plants used for flavoring or as garnish.

- Free Setup / Art / Logos
- Bleeds Allowed on All Sides
- Temper Proof Seal
- Elegant Wide Mouth, Easy Access Glass Jar with Black Lid
- High Quality, Food Grade, Durable, Tin Plated Steel Can
- Fresh Packed upon Receipt of Order in USA

Material

Package : Bulk, Glass Jar or Tin Can, Custom Gloss Label

Gift Box (option) : 111# Gloss Cover

Printing

Digital : Full Color Printing on the Label

Die Cutting

No Charge for Standard Shape

Custom Shape, add \$150.00 (G) each shape

Option

Artwork Change : \$67.00 (G) each

U3435G/3435T

Gift Box (option)

with full-color custom graphics



U4101G~4106G

- 1 3/8" diameter (Top Label)
- 7" x 7/8" (Side Label)
- 2 1/8" x 2" (Glass Jar)
- 2 3/16" x 2 3/16" x 2 1/8" (Gift Box)

Various Net Wt.



U4101T~4106T

4" x 1/2" (Top Label)

6 5/8" x 1 27/32" (Side Label)

1 25/32" x 1 25/32" x 2 1/2" (Tin Can)

1 7/8" x 1 7/8" x 2 5/8" (Gift Box)

Various Net Wt.

SEASONINGS

All-natural Gourmet Seasonings

BBQ

A smoky, sweet and salty seasoning for all types of grilled meat and poultry and great in homemade barbecue sauces.

Lemon Pepper

A salted combination of that black pepper kick with the tartness of lemon. Great on poultry, fish, meat, artichokes, asparagus and broccoli.

Seafood

A salted blend of pungent and sweet herbs mixed with spices. Excellent on fish and seafood; or to season vegetables and poultry.

Steak

A salted blend of pepper, garlic, and other spices. It's robust flavor and texture compliments beef and dense fish like tuna.

Cajun

A salted herb and spice blend with a peppery flair; great for adding a Cajun kick to meats, poultry, and seafood.

Jamaican Jerk

A spicy blend of pepper, onion, garlic, and herbs; add a spicy, peppery kick to fish, poultry, and grilled meats.

		DIGITAL					
ITEM NO		96	240	480	960	2400	4800
U4141G	BBQ	11.17	9.77	9.29	9.05	8.91	8.86
U4142G	Lemon Pepper	11.17	9.77	9.29	9.05	8.91	8.86
U4143G	Seafood	11.17	9.77	9.29	9.05	8.91	8.86
U4144G	Steak	11.17	9.77	9.29	9.05	8.91	8.86
U4145G	Cajun	11.17	9.77	9.29	9.05	8.91	8.86
U4146G	Jamaican Jerk	12.17	10.77	10.29	10.05	9.91	9.86
U3435G	Gift Box (option)	5.07	3.50	2.94	2.24	1.65	1.31
U4141T	BBQ	12.59	11.18	10.70	10.47	10.33	10.28
U4142T	Lemon Pepper	13.59	12.18	11.70	11.47	11.33	11.28
U4143T	Seafood	12.59	11.18	10.70	10.47	10.33	10.28
U4144T	Steak	13.59	12.18	11.70	11.47	11.33	11.28
U4145T	Cajun	13.59	12.18	11.70	11.47	11.33	11.28
U4146T	Jamaican jerk	13.59	12.18	11.70	11.47	11.33	11.28
U3435T	Gift Box (option)	5.07	3.50	2.94	2.24	1.65	1.31

6C

Specifications

Our seasonings offer unique blends of freshness, taste, and creativity, sourced from our trusted network of growers from around the world.

- Free Setup / Art / Logos
- Bleeds Allowed on All Sides
- Temper Proof Seal
- Elegant Wide Mouth, Easy Access Glass Jar with Black Lid
- High Quality, Food Grade, Durable, Tin Plated Steel Can
- Fresh Packed upon Receipt of Order in USA

Material

Package : Bulk, Glass Jar or Tin Can, Custom Gloss Label
Gift Box (option) : 111# Gloss Cover

Printing

Digital : Full Color Printing on the Label

Die Cutting

No Charge for Standard Shape

Custom Shape, add \$150.00 (G) each shape

Option

Artwork Change : \$67.00 (G) each

U4141T~4146T

4" x 1/2" (Top Label)

6 5/8" x 1 27/32" (Side Label)

1 25/32" x 1 25/32" x 2 1/2" (Tin Can)

1 7/8" x 1 7/8" x 2 5/8" (Gift Box)

U4141G~4146G

1 3/8" diameter (Top Label)

7" x 7/8" (Side Label)

2 1/8" x 2" (Glass Jar)

2 3/16" x 2 3/16" x 2 1/8" (Gift Box)

Various Net Wt.

U3435G/3435T

Gift Box (option)

with full-color custom graphics

PEPPERCORNS

All-natural Whole Peppercorns

Black Peppercorns

Black peppercorns are left on the vine to fully mature, then are picked and dried in the sun or blanched before drying. They have a strong spicy flavor due to the presence of the chemical piperine and varying amounts of essential oil.

Green Peppercorns

Green peppercorns are harvested while immature and unripe, then either air-dried, freeze-dried. They're aromatic, with a fresher, fruitier flavor than white or black pepper, but not nearly as sharp and astringent as black.

White Peppercorns

White peppercorns are the seeds of black peppercorns, soaked to remove the dark colored casings before drying. The resulting flavor is hotter and more pungent than black peppercorns, with a slightly fermented odor.

Szechuan Peppercorns

Unrelated to the pepper family, these are the berries of a prickly ash tree, native to the Szechuan province of southwest China. When chewed they cause a numbing sensation on the tongue. Szechuan pepper is very aromatic, with a scent of anise and a sweet fresh citrus flavor.

Rainbow Peppercorns

Our rainbow peppercorn mix is a four-pepper blend of black, white, green, and pink peppercorns. Rainbow pepper is a colorful way to enjoy the flavors from a combination of peppercorns, adding heat and flavor to a multitude of recipes.

Pink Peppercorns

Not peppercorns at all, but the berries of the shrub originated in Peru. Although mild and sweet, they are quite pungent but not peppery. They are very fruity and sweet with spiciness and flavors of juniper, aniseed and pine.



DIGITAL

ITEM NO		96	240	480	960	2400	4800
U4161G	Black Peppercorns	11.17	9.77	9.29	9.05	8.91	8.86
U4162G	Green Peppercorns	12.17	10.77	10.29	10.05	9.91	9.86
U4163G	White Peppercorns	12.17	10.77	10.29	10.05	9.91	9.86
U4164G	Szechuan Peppercorns	16.17	14.77	14.29	14.05	13.91	13.86
U4165G	Rainbow Peppercorns	12.17	10.77	10.29	10.05	9.91	9.86
U4166G	Pink Peppercorns	12.17	10.77	10.29	10.05	9.91	9.86
U3435G	Gift Box (option)	5.07	3.50	2.94	2.24	1.65	1.31
U4161T	Black Peppercorns	12.59	11.18	10.70	10.47	10.33	10.28
U4162T	Green Peppercorns	15.59	14.18	13.70	13.47	13.33	13.28
U4163T	White Peppercorns	13.59	12.18	11.70	11.47	11.33	11.28
U4164T	Szechuan Peppercorns	19.59	18.18	17.70	17.47	17.33	17.28
U4165T	Rainbow Peppercorns	13.59	12.18	11.70	11.47	11.33	11.28
U4166T	Pink Peppercorns	14.59	13.18	12.70	12.47	12.33	12.28
U3435T	Gift Box (option)	5.07	3.50	2.94	2.24	1.65	1.31

6C

Specifications

Black, white, and green peppercorns all come from the same vine, but are harvested at various stages of growth. Sweet and spicy pink peppercorns are dried berries from South America. Chinese Szechuan peppercorns have a distinctly pungent and spicy flavor.

- Free Setup / Art / Logos
- Bleeds Allowed on All Sides
- Temper Proof Seal
- Elegant Wide Mouth, Easy Access Glass Jar with Black Lid
- High Quality, Food Grade, Durable, Tin Plated Steel Can
- Fresh Packed upon Receipt of Order in USA

Material

Package : Bulk, Glass Jar or Tin Can, Custom Gloss Label

Gift Box (option) : 111# Gloss Cover

Printing

Digital : Full Color Printing on the Label

Die Cutting

No Charge for Standard Shape

Custom Shape, add \$150.00 (G) each shape

Option

Artwork Change : \$67.00 (G) each

U3435G/3435T

Gift Box (option)

with full-color custom graphics



U4161G~4166G

1 3/8" diameter (Top Label)

7" x 7/8" (Side Label)

2 1/8" x 2" (Glass Jar)

2 3/16" x 2 3/16" x 2 1/8" (Gift Box)

Various Net Wt.



U4161T~4166T

4" x 1/2" (Top Label)

6 5/8" x 1 27/32" (Side Label)

1 25/32" x 1 25/32" x 2 1/2" (Tin Can)

1 7/8" x 1 7/8" x 2 5/8" (Gift Box)

Various Net Wt.

CHILI PEPPERS

All-natural Hot Chili Peppers

Cayenne Pepper

Cayenne chilies are usually sold as a powder. The word cayenne comes from the city of Cayenne in French Guiana. Cayenne is great in soups and sauces, on pizzas, as well as over meats and seafoods. 30,000 to 50,000 Scoville hot units.

Ancho Chili Pepper

Ancho Chili is a dark smoky chili with a deep rich flavor and mild to medium heat. Their flavor is somewhat sweet and a little raisin like. When fresh they are referred to as poblanos. 1,000 to 1,500 Scoville heat units.

Chipotle Chili Pepper

A chipotle pepper is a smoked, dried jalapeno. As they turn red on the vine, they are plucked and smoked until dried, turning them into chipotle peppers. 2,500 to 8,000 Scoville hot units.

Jalapeno Pepper

A jalapeno pepper is a fruit of the Capsicum pod type. While originating in Mexico, it is now grown worldwide for its popular flavor and mild heat level, which averages around 5,000 Scoville Heat Units. That is hot, but not too hot.

Paprika

It is made of a combination of dried peppers from the Capsicum annum family, then grinding them to a fine, rich red powder. Its flavor varies from mild to pretty robust, but it's never as hot as chili or cayenne, its main purpose is to add flavor and color, more than heat. 250 to 1,000 Scoville heat units.

Red Pepper

Red pepper flakes are made from a mix of peppers from the Capsicum annum family, mostly Cayenne. Seeds are there to add spiciness. The primary use is to achieve heat. 30,000–50,000 Scoville heat units.

Specifications

Chili Peppers are widely used in many cuisines as a spice to add flavor and heat to various dishes. Chili Peppers can be eaten fresh or added whole to your food. When dried they can be finely ground into chili powder for use with barbecue, hot curry, and other spicy sauces.

- Free Setup / Art / Logos
- Bleeds Allowed on All Sides
- Temper Proof Seal
- Elegant Wide Mouth, Easy Access Glass Jar with Black Lid
- High Quality, Food Grade, Durable, Tin Plated Steel Can
- Fresh Packed upon Receipt of Order in USA

Material

Package : Bulk, Glass Jar or Tin Can, Custom Gloss Label
Gift Box (option) : 111# Gloss Cover

Printing

Digital : Full Color Printing on the Label

Die Cutting

No Charge for Standard Shape
Custom Shape, add \$150.00 (G) each shape

Option

Artwork Change : \$67.00 (G) each

ITEM NO		DIGITAL					
		96	240	480	960	2400	4800
U4181G	Cayenne Pepper	10.17	8.77	8.29	8.05	7.91	7.86
U4182G	Ancho Chili Pepper	12.17	10.77	10.29	10.05	9.91	9.86
U4183G	Chipotle Chili Pepper	12.17	10.77	10.29	10.05	9.91	9.86
U4184G	Jalapeno Pepper	11.17	9.77	9.29	9.05	8.91	8.86
U4185G	Paprika	11.17	9.77	9.29	9.05	8.91	8.86
U4186G	Red Pepper	10.17	8.77	8.29	8.05	7.91	7.86
U3435G	Gift Box (option)	5.07	3.50	2.94	2.24	1.65	1.31
U4181T	Cayenne Pepper	12.59	11.18	10.70	10.47	10.33	10.28
U4182T	Ancho Chili Pepper	13.59	12.18	11.70	11.47	11.33	11.28
U4183T	Chipotle Chili Pepper	14.59	13.18	12.70	12.47	12.33	12.28
U4184T	Jalapeno Pepper	13.59	12.18	11.70	11.47	11.33	11.28
U4185T	Paprika	12.59	11.18	10.70	10.47	10.33	10.28
U4186T	Red Pepper	12.59	11.18	10.70	10.47	10.33	10.28
U3435T	Gift Box (option)	5.07	3.50	2.94	2.24	1.65	1.31



U4181T~4186T

4" x 1 1/2" (Top Label)
 6 5/8" x 1 27/32" (Side Label)
 1 25/32" x 1 25/32" x 2 1/2" (Tin Can)
 1 7/8" x 1 7/8" x 2 5/8" (Gift Box)
 Various Net Wt.

U4181G~4186G

1 3/8" diameter (Top Label)
 7" x 7/8" (Side Label)
 2 1/8" x 2" (Glass Jar)
 2 3/16" x 2 3/16" x 2 1/8" (Gift Box)
 Various Net Wt.

U3435G/3435T
 Gift Box (option)
 with full-color
 custom graphics

TEAS

All-natural Signature Teas

Masala Chai

Our Masala Chai tea blend combines premium black tea with cinnamon, cardamom, and ginger. Originating in India, Masala means 'a blend of spices', and chai means 'tea'. So, Masala Chai is literally spiced tea.

Gunpowder

Gunpowder is a classic green tea from China in which each leaf has been rolled into a small round pellet. Its name comes from its resemblance to grains of gunpowder. When blended with spearmint, it becomes Moroccan Mint tea.

English Breakfast

English Breakfast is a full-bodied black tea blend that goes well with a traditional English breakfast. Made from top quality tea leaves, our English Breakfast stays true to the classic. May be enjoyed plain or with a drop of milk.

Earl Grey

Earl Grey is a classic blend of artisan black tea, flavored with bergamot (a citrus fruit). Fresh citrus aroma from the bergamot oil makes Earl Grey perfect for the afternoon. Its taste is often described as bright, refreshing, and bold.

Vanilla Cream

Vanilla Cream Tea is a flavored black tea with vanilla beans and vanilla creme flavor. This black tea is sweet and is rich in antioxidants. It is a natural stress reliever and a good substitute for ice-cream.

Peach Tea

Our juicy Peach black tea is a sweet and mellow blend of black tea, peach pieces, marigold petals and natural peach flavoring. A perfect option for those who enjoy a sweet, floral and fruity tea.



DIGITAL

6C

ITEM NO		96	240	480	960	2400	4800
U4201G	Earl Grey	11.17	9.77	9.29	9.05	8.91	8.86
U4202G	Masala Chai	12.17	10.77	10.29	10.05	9.91	9.86
U4203G	Vanilla Cream	11.17	9.77	9.29	9.05	8.91	8.86
U4204G	Gunpowder	12.17	10.77	10.29	10.05	9.91	9.86
U4205G	Peach Tea	11.17	9.77	9.29	9.05	8.91	8.86
U4206G	English Breakfast	11.17	9.77	9.29	9.05	8.91	8.86
U3435G	Gift Box (option)	5.07	3.50	2.94	2.24	1.65	1.31
U4201T	Earl Grey	13.59	12.18	11.70	11.47	11.33	11.28
U4202T	Masala Chai	14.59	13.18	12.70	12.47	12.33	12.28
U4203T	Vanilla Cream	13.59	12.18	11.70	11.47	11.33	11.28
U4204T	Gunpowder	14.59	13.18	12.70	12.47	12.33	12.28
U4205T	Peach Tea	13.59	12.18	11.70	11.47	11.33	11.28
U4206T	English Breakfast	12.59	11.18	10.70	10.47	10.33	10.28
U3435T	Gift Box (option)	5.07	3.50	2.94	2.24	1.65	1.31

Specifications

Discover our rich, energizing & full-bodied black teas, traditional pure green teas, and exciting new blends flavored with peach or vanilla.

- Free Setup / Art / Logos
- Bleeds Allowed on All Sides
- Temper Proof Seal
- Elegant Wide Mouth, Easy Access Glass Jar with Black Lid
- High Quality, Food Grade, Durable, Tin Plated Steel Can
- Fresh Packed upon Receipt of Order in USA

Material

Package : Bulk, Glass Jar or Tin Can, Custom Gloss Label

Gift Box (option) : 111# Gloss Cover

Printing

Digital : Full Color Printing on the Label

Die Cutting

No Charge for Standard Shape

Custom Shape, add \$150.00 (G) each shape

Option

Artwork Change : \$67.00 (G) each

U4201G~4206G

1 3/8" diameter (Top Label)

7" x 7/8" (Side Label)

2 1/8" x 2" (Glass Jar)

2 3/16" x 2 3/16" x 2 1/8" (Gift Box)

Various Net Wt.



U3435G/3435T

Gift Box (option)

with full-color custom graphics

U4201T~4206T

4" x 1/2" (Top Label)

6 5/8" x 1 27/32" (Side Label)

1 25/32" x 1 25/32" x 2 1/2" (Tin Can)

1 7/8" x 1 7/8" x 2 5/8" (Gift Box)

Various Net Wt.

FLORAL TEAS

All-natural Exquisite Floral Teas

Hibiscus

Hibiscus tea, made from dried parts of the hibiscus plant, is deep red in color. It has sweet and tart flavors, similar to cranberry, and may be consumed hot or iced.

Marigold

Marigold, a flowering plant also known as calendula, can be served as a tea or used as an ingredient in various herbal formulations despite its slightly bitter taste.

Chamomile

Chamomile is an herb that comes from the daisy-like flowers of the Asteraceae plant family. It has been consumed for centuries as a natural remedy for several health conditions. It can also be used as a sleep-promoter.

		DIGITAL 6C					
ITEM NO		96	240	480	960	2400	4800
U4301G	Hibiscus	11.17	9.77	9.29	9.05	8.91	8.86
U4302G	Marigold	10.17	8.77	8.29	8.05	7.91	7.86
U4303G	Chamomile	10.17	8.77	8.29	8.05	7.91	7.86
U4304G	Lavender Ultra	11.17	9.77	9.29	9.05	8.91	8.86
U4305G	Jasmine	12.17	10.77	10.29	10.05	9.91	9.86
U4306G	Rose Petal	10.17	8.77	8.29	8.05	7.91	7.86
U3435G	Gift Box (option)	5.07	3.50	2.94	2.24	1.65	1.31
U4301T	Hibiscus	12.59	11.18	10.70	10.47	10.33	10.28
U4302T	Marigold	11.59	10.18	9.70	9.47	9.33	9.28
U4303T	Chamomile	12.59	11.18	10.70	10.47	10.33	10.28
U4304T	Lavender Ultra	12.59	11.18	10.70	10.47	10.33	10.28
U4305T	Jasmine	14.59	13.18	12.70	12.47	12.33	12.28
U4306T	Rose Petal	11.59	10.18	9.70	9.47	9.33	9.28
U3435T	Gift Box (option)	5.07	3.50	2.94	2.24	1.65	1.31

Lavender Ultra

Lavender tea is made by brewing the purple buds of the *Lavandula angustifolia* plant with hot water. Lavender tea may help promote sleep, improve skin health, boost mood, and soothe anxiety.

Jasmine

Jasmine is one of the most famous scented teas in China and increasingly attracts popularity worldwide. Its taste is sweet and delicate while the aroma is soothing and very pleasant.

Rose Petal

Rose bud tea is made from the petals of rose plants. In general, rose bud tea has a mildly sweet taste and a lingering aftertaste that entices taste buds after each sip.

Specifications

Floral teas come in a variety of delicious flavors and are naturally free of sugar, calories, and caffeine. Many floral teas also offer health-promoting effects.

- Free Setup / Art / Logos
- Bleeds Allowed on All Sides
- Temper Proof Seal
- Elegant Wide Mouth, Easy Access Glass Jar with Black Lid
- High Quality, Food Grade, Durable, Tin Plated Steel Can
- Fresh Packed upon Receipt of Order in USA

Material

Package : Bulk, Glass Jar or Tin Can, Custom Gloss Label
Gift Box (option) : 111# Gloss Cover

Printing

Digital : Full Color Printing on the Label

Die Cutting

No Charge for Standard Shape

Custom Shape, add \$150.00 (G) each shape

Option

Artwork Change : \$67.00 (G) each

U4301G~4306G

1 3/8" diameter (Top Label)
 7" x 7/8" (Side Label)
 2 1/8" x 2" (Glass Jar)
 2 3/16" x 2 3/16" x 2 1/8" (Gift Box)

Various Net Wt.

U4301T~4306T

4" x 1/2" (Top Label)
 6 5/8" x 1 27/32" (Side Label)

1 25/32" x 1 25/32" x 2 1/2" (Tin Can)
 1 7/8" x 1 7/8" x 2 5/8" (Gift Box)
 Various Net Wt.



U3435G/3435T

Gift Box (option)

with full-color custom graphics

SUPERFOOD POWDER

Organic Superfood Powder

Beet Root Powder

Beet root powder is growing in popularity as a natural health-boosting supplement. Beets generally have an earthy, bitter flavor. Beets can be mixed with water to create a juice, or can be added to smoothies, sauces, or baked goods.

Mesquite Powder

Naturally sweet molasses-like flavor with rich nutty hints similar to carob. It is a tasty addition to smoothies and shakes, coffee, baked goods, and chocolates. The high fiber levels take a long time to assimilate.

Turmeric Powder

Turmeric may be the most effective nutritional supplement in existence. It has gained in popularity in the United States. The colorful and fragrant rhizome adds unique earthy, slightly bitter flavor to foods and beverages.

Cacao Powder

Cacao is known for its healthful benefits. The powder has a rich flavor, and can be added to smoothies, energy bars, herbal beverages, and extracts. The aroma has a slight floral aspect balanced with deep chocolate undertones.

Spirulina Powder

The high concentration of amino acids has made spirulina a popular nutritional supplement. In addition to amino acids, spirulina is also a rich source of numerous other nutrients, including many essential vitamins and minerals.

Maca Powder

Maca root is a nutritional powerhouse. It grows wild in the frigid ground of the Andes mountains thousands of feet above sea level in Peru. Maca root can be blended into smoothies, or incorporated into baking recipes.

		DIGITAL					
ITEM NO		96	240	480	960	2400	4800
U4401G	Beet Root Powder	12.17	10.77	10.29	10.05	9.91	9.86
U4402G	Mesquite Powder	11.17	9.77	9.29	9.05	8.91	8.86
U4403G	Turmeric Powder	11.17	9.77	9.29	9.05	8.91	8.86
U4404G	Cacao Powder	11.17	9.77	9.29	9.05	8.91	8.86
U4405G	Spirulina Powder	12.17	10.77	10.29	10.05	9.91	9.86
U4406G	Maca Powder	12.17	10.77	10.29	10.05	9.91	9.86
U3435G	Gift Box (option)	5.07	3.50	2.94	2.24	1.65	1.31
U4401T	Beet Root Powder	14.59	13.18	12.70	12.47	12.33	12.28
U4402T	Mesquite Powder	12.59	11.18	10.70	10.47	10.33	10.28
U4403T	Turmeric Powder	13.59	12.18	11.70	11.47	11.33	11.28
U4404T	Cacao Powder	12.59	11.18	10.70	10.47	10.33	10.28
U4405T	Spirulina Powder	14.59	13.18	12.70	12.47	12.33	12.28
U4406T	Maca Powder	13.59	12.18	11.70	11.47	11.33	11.28
U3435T	Gift Box (option)	5.07	3.50	2.94	2.24	1.65	1.31

U3435G/3435T

Gift Box (option)

with full-color custom graphics

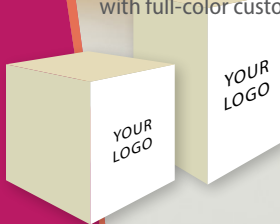

U4401G~4406G

1 3/8" diameter (Top Label)
 7" x 7/8" (Side Label)
 2 1/8" x 2" (Glass Jar)
 2 3/16" x 2 3/16" x 2 1/8" (Gift Box)

Various Net Wt.



Specifications

Superfood Powders are nutrient rich and high in antioxidants. It is a convenient and fast way to get a balanced meal without the hassle of preparing a full meal for the busy everyday person. Add them to your existing diet for a hassle-free way of hitting your daily nutritional requirements.

- Free Setup / Art / Logos
- Bleeds Allowed on All Sides
- Temper Proof Seal
- Elegant Wide Mouth, Easy Access Glass Jar with Black Lid
- High Quality, Food Grade, Durable, Tin Plated Steel Can
- Fresh Packed upon Receipt of Order in USA

Material

Package : Bulk, Glass Jar or Tin Can, Custom Gloss Label

Gift Box (option) : 111# Gloss Cover

Printing

Digital : Full Color Printing on the Label

Die Cutting

No Charge for Standard Shape

Custom Shape, add \$150.00 (G) each shape

Option

Artwork Change : \$67.00 (G) each

U4401T~4406T

4" x 1/2" (Top Label)
 6 5/8" x 1 27/32" (Side Label)

1 25/32" x 1 25/32" x 2 1/2" (Tin Can)
 1 7/8" x 1 7/8" x 2 5/8" (Gift Box)

Various Net Wt.

PROTEIN POWDER

Organic Protein Powder

Hemp Protein

Hemp is a complete protein, containing all nine essential amino acids, plus fiber, healthy fats and minerals. It has an earthy, nutty taste and is often added to shakes or smoothies to boost protein intake.

Whey Protein

Whey protein provides substantial amounts of the essential amino acids. It can be added to liquids or soft foods, or blended with ice and fresh fruit to make a smoothie.

Pea Protein

Pea protein is a great source of protein and iron. It can aid muscle growth, weight loss and heart health. It is typically used as smoothies and shakes and is a great fit for almost any diet since it's naturally vegan and hypoallergenic.

Brown Rice Protein

Brown rice protein powder is made by separating the carbohydrate from the protein. It contains enough of the nine essential amino acids to be a great plant-based muscle-builder.

Brown Flax Seeds

Since the omega-3 essential fatty acids that flax provides, flax is one of the most widely accepted of the herbal health foods. It can be sprinkled on salads or added to baked goods, smoothies, and other culinary dishes.

Chia Seeds

Chia seeds are popular in the United States for its antioxidant and fiber content and as a high mucilage superfood that provides Omega 3 fatty acids. It is best eaten with cereal, added to smoothies, or made into fruity beverages.



ITEM NO		96	240	480	960	2400	4800
U4441G	Hemp Protein	12.17	10.77	10.29	10.05	9.91	9.86
U4442G	Whey Protein	14.17	12.77	12.29	12.05	11.91	11.86
U4443G	Pea Protein	11.17	9.77	9.29	9.05	8.91	8.86
U4444G	Brown Rice Protein	11.17	9.77	9.29	9.05	8.91	8.86
U4445G	Brown Flax Seeds	13.17	11.77	11.29	11.05	10.91	10.86
U4446G	Chia Seeds	11.17	9.77	9.29	9.05	8.91	8.86
U3435G	Gift Box (option)	5.07	3.50	2.94	2.24	1.65	1.31
U4441T	Hemp Protein	13.59	12.18	11.70	11.47	11.33	11.28
U4442T	Whey Protein	17.59	16.18	15.70	15.47	15.33	15.28
U4443T	Pea Protein	13.59	12.18	11.70	11.47	11.33	11.28
U4444T	Brown Rice Protein	13.59	12.18	11.70	11.47	11.33	11.28
U4445T	Brown Flax Seeds	15.59	14.18	13.70	13.47	13.33	13.28
U4446T	Chia Seeds	13.59	12.18	11.70	11.47	11.33	11.28
U3435T	Gift Box (option)	5.07	3.50	2.94	2.24	1.65	1.31

6C

Specifications

Protein Powder is a popular nutritional supplement used by athletes and other fitness enthusiasts around the world. In combination with a balanced diet and fitness plan, protein supplements can aid in weight loss, help tone muscles, and satisfy daily nutritional or caloric requirements.

- Free Setup / Art / Logos
- Bleeds Allowed on All Sides
- Temper Proof Seal
- Elegant Wide Mouth, Easy Access Glass Jar with Black Lid
- High Quality, Food Grade, Durable, Tin Plated Steel Can
- Fresh Packed upon Receipt of Order in USA

Material

Package : Bulk, Glass Jar or Tin Can, Custom Gloss Label

Gift Box (option) : 111# Gloss Cover

Printing

Digital : Full Color Printing on the Label

Die Cutting

No Charge for Standard Shape

Custom Shape, add \$150.00 (G) each shape

Option

Artwork Change : \$67.00 (G) each

U3435G/3435T

Gift Box (option)

with full-color custom graphics

YOUR
LOGO

YOUR
LOGO

U4441G~4446G

- 1 3/8" diameter (Top Label)
- 7" x 7/8" (Side Label)
- 2 1/8" x 2" (Glass Jar)
- 2 3/16" x 2 3/16" x 2 1/8" (Gift Box)

Various Net Wt.

Gift Box
(option)



U4441T~4446T

- 4" x 1/2" (Top Label)
- 6 5/8" x 1 27/32" (Side Label)

1 25/32" x 1 25/32" x 2 1/2" (Tin Can)

1 7/8" x 1 7/8" x 2 5/8" (Gift Box)

Various Net Wt.

NUTS

Nuts : Nutrition Powerhouse

Cashews

The cashew seed is commonly eaten on its own, used in recipes, or processed into cashew cheese or cashew butter. They've been linked to benefits like weight loss, improved blood sugar control, and a healthier heart.

Almonds

Almonds contain antioxidants, vitamins, minerals, protein, and fiber, and so they may offer a number of health benefits. People can eat almonds raw or toasted as a snack or add them to sweet or savory dishes.

Hazelnuts

Hazelnuts are rich in nutrients and have a high content of protein, fats, vitamins and minerals. It has a sweet flavor, make a tasty snack and a great addition to many dishes.

Pistachios

Pistachios are a type of tree nut with numerous health benefits including fats, protein, fiber, and antioxidants. What's more, they contain several essential nutrients and can aid weight loss and heart and gut health.

Walnuts

Walnuts are the only nut significantly high in omega-3 ALA. Omega-3s are essential fatty acids critical to various body processes. They may enhance heart and bone health and help in weight management, among other benefits.

Pecans

Pecans are a type of tree nut native to North America. They're a common ingredient in appetizers, desserts, and main dishes alike. This nutrient-dense nut boasts multiple vitamins, minerals and bio active compounds.

Specifications

Nuts are a very popular snack that provide key proteins, nutrients, and healthy fats to your daily diet. They can also promote a healthy heart. Above all they are tasty, convenient, and extremely loved across the world as snacks.

- Free Setup / Art / Logos
- Bleeds Allowed on All Sides
- Temper Proof Seal
- Elegant Wide Mouth, Easy Access Glass Jar with Metal Lid
- Fresh Packed upon Receipt of Order in USA

Material

Package : Bulk, Glass Jar, Custom Gloss Label

Gift Box (option) : 111# Gloss Cover

Printing

Digital : Full Color Printing on the Label

Die Cutting

No Charge for Standard Shape

Custom Shape, add \$150.00 (G) each shape

Option

Artwork Change : \$67.00 (G) each



DIGITAL

6C

ITEM NO		96	240	480	960	2400	4800
U4461	Cashews	15.00	13.59	13.12	12.88	12.74	12.69
U4462	Almonds	14.00	12.59	12.12	11.88	11.74	11.69
U4463	Hazelnuts	16.00	14.59	14.12	13.88	13.74	13.69
U4464	Pistachios	14.00	12.59	12.12	11.88	11.74	11.69
U4465	Walnuts	13.00	11.59	11.12	10.88	10.74	10.69
U4466	Pecans	15.00	13.59	13.12	12.88	12.74	12.69
U3436G	Gift Box (option)	5.07	3.50	2.94	2.24	1.65	1.31



U3436G

Gift Box (option)

2 3/8" x 2 3/8" x 2 7/8" (Gift Box)

with full-color custom graphics

U4461~4466

7 3/4" x 1 1/2" (Side Label)

2 1/4" x 2 5/8" (Glass Jar)

Various Net Wt.



SPROUTING SEEDS

Organic Sprouting Seeds

Fenugreek Seeds

Fenugreek seeds are one of the most aromatic and unique varieties of sprouting seeds. Famous for its rich maple-scented seeds, organic fenugreek sprouts are quick to harvest as a fragrant complement in any curry or biryani.

Alfalfa Seeds

Alfalfa has since become the most popular sprouting seed on the planet. Organic alfalfa sprouts are one of the most delicious and diverse varieties of seed sprouts available. They are simple to grow, full of raw vitamins and nutrients.

Mung Bean Seeds

Mung bean sprouts are one of the most delicious and popular sprouts available. Dense with essential protein, fiber, iron, and plenty of B vitamins, mung bean sprouts are a low-calorie, nutrient-rich snack ideal for many weight loss goals.

Broccoli Seeds

Broccoli sprout seeds offer more nutritional benefits without calories, sugar, or fats. Up to 50x more nutrients than fully matured raw broccoli. Broccoli sprouts are a recognized superfood rich in sulforaphane, an essential compound.

Daikon Radish Seeds

Daikon radish sprouts are a great low-calorie source for calcium, potassium, and Vitamin C. Grown for its robust spiced peppery flavor, Daikon radish sprouts are a gourmet complement to many dishes.

Wheat Seeds

Hard red organic winter wheat is undoubtedly the best wheat we have ever used for growing wheatgrass and sprouts. This organic hard red winter wheat has an incredible germination rate and sweet sprout tails.



ITEM NO		96	240	480	960	2400	4800
U4501G	Fenugreek Seeds	14.17	12.77	12.29	12.05	11.91	11.86
U4502G	Alfalfa Seeds	16.17	14.77	14.29	14.05	13.91	13.86
U4503G	Mung Bean Seeds	12.17	10.77	10.29	10.05	9.91	9.86
U4504G	Broccoli Seeds	18.17	16.77	16.29	16.05	15.91	15.86
U4505G	Daikon Radish Seeds	14.17	12.77	12.29	12.05	11.91	11.86
U4506G	Wheat Seeds	12.17	10.77	10.29	10.05	9.91	9.86
U3435G	Gift Box (option)	5.07	3.50	2.94	2.24	1.65	1.31
U4501T	Fenugreek Seeds	19.59	18.18	17.70	17.47	17.33	17.28
U4502T	Alfalfa Seeds	19.59	18.18	17.70	17.47	17.33	17.28
U4503T	Mung Bean Seeds	15.59	14.18	13.70	13.47	13.33	13.28
U4504T	Broccoli Seeds	23.59	22.18	21.70	21.47	21.33	21.28
U4505T	Daikon Radish Seeds	17.59	16.18	15.70	15.47	15.33	15.28
U4506T	Wheat Seeds	14.59	13.18	12.70	12.47	12.33	12.28
U3435T	Gift Box (option)	5.07	3.50	2.94	2.24	1.65	1.31

U3435G/3435T

Gift Box (option)

with full-color custom graphics



U4501G~4506G

- 1 3/8" diameter (Top Label)
- 7" x 7/8" (Side Label)
- 2 1/8" x 2" (Glass Jar)
- 2 3/16" x 2 3/16" x 2 1/8" (Gift Box)

Various Net Wt.



U4501T~4506T

- 4" x 1/2" (Top Label)
- 6 5/8" x 1 27/32" (Side Label)

- 1 25/32" x 1 25/32" x 2 1/2" (Tin Can)
- 1 7/8" x 1 7/8" x 2 5/8" (Gift Box)

Various Net Wt.

Specifications

Sprouts are young plants that are harvested a mere few days just after they germinate. Generally speaking, sprouts have a higher concentration of nutrients than their fully-grown counterparts. Sprouts also have very high amounts of enzymes that help to boost your metabolism.

- Free Setup / Art / Logos
- Bleeds Allowed on All Sides
- Temper Proof Seal
- Elegant Wide Mouth, Easy Access Glass Jar with Black Lid
- High Quality, Food Grade, Durable, Tin Plated Steel Can
- Fresh Packed upon Receipt of Order in USA

Material

Package : Bulk, Glass Jar or Tin Can, Custom Gloss Label
Gift Box (option) : 111# Gloss Cover

Printing

Digital : Full Color Printing on the Label

Die Cutting

No Charge for Standard Shape

Custom Shape, add \$150.00 (G) each shape

Option

Artwork Change : \$67.00 (G) each

EDIBLE FLOWER SEEDS

Grow Salad Topper from Seeds

Nasturtium

Nasturtium plants are easy to grow. Their bold blooms and edible leaves, flowers, and seedpods make them an especially fun flower plant and a favorite companion plant in the garden.

Borage

Growing borage provides cucumber-flavored leaves for tea and other beverages as well as bright, starry blue flowers for decorating salads. All parts of the plant, except the roots, are flavorful and have culinary or medicinal uses.

Calendula

Calendula is a plant known as pot marigold, bearing an edible orange or yellow daisy-like flower. They brighten herbal tea blends and make a tasty calendula tea infusion.

Lavender

A relative of mint, the lavender plant is adorned with violet flowers and green or pale grey leaves. Both the flowers and leaves can be eaten and have a pleasant yet slightly bitter flavor.

Viola

Violas are edible flowers and eaten as garnishes and salad ingredients. They can also be candied for a frosted effect, or used to decorate cakes or other confections.

Cornflower

With a neutral flavor, cornflower really is the most versatile edible flower and is excellent for both savory and sweet dishes. Use whole flowers or separate the florets for a punch of vivid blue, pink or aubergine.

Specifications

Edible flower seeds help to add various unique flavors to your dishes. They can be used as simple garnish to add various colors to your plate or added to salads to blend together various flavors.

- Free Setup / Art / Logos
- Bleeds Allowed on All Sides
- Fresh Packed upon Receipt of Order in USA

Material

Package : 8pt Gloss Cover

Printing

Digital : Full Color Printing on Front & Back

Die Cutting

No Charge for Standard Shape

Custom Shape, add \$150.00 (G) each shape

Option

Artwork Change : \$67.00 (G) each

Packaging : Bulk

U4521~4526

4" x 3 3/4"

Various Net Wt.

LAVENDER
Munstead-type
Lavandula angustifolia

YOUR LOGO

Minimum 100 seeds ⌘ Days 100-110 ⌘ Perennial

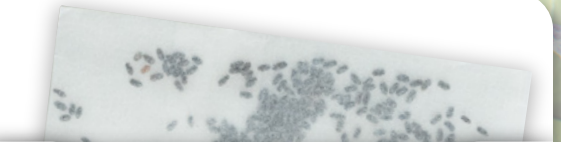

LAVENDER, Munstead-type

Lavandula angustifolia

LIFE CYCLE : Perennial

SOWING : (Transplant: recommended) Sow seeds 1/8" deep in a flat 8-10 weeks before the last frost. Seeds require some light for germination. Transplant to individual pots when the plants are large enough to handle. Transplant to the field in the spring after the last frost. Plant shallowly, so the soil line is just above the top roots of the plant. Space plants 12-18" apart in rows 24-36" apart. In late fall, clip plants back to below the flower stems and mulch heavily. During the second year, cuttings can be taken from August-November, when the stems are semi-hardened, but before they have been subjected to a hard freeze.

(Direct Seed) Not recommended.

GERMINATION : 14-21 days at 65-70°F

LIGHT : Sun

SOIL : Plant in a light, well-drained, gravelly soil. Lavender likes a protected, south-facing location. Soil that is slightly acidic to slightly alkaline is most desirable. If the soil pH falls below 6.5, the soil should be treated with lime to adjust the pH to no more than 8.3.

MATURITY : 100-110 days

HARVEST : (Edible flowers) Harvest the flower spikes on a dry, warm, sunny day just as the flowers are about to open. Hang to dry in a dry, well-ventilated space out of direct sunlight.

 971 Stewart Ave. Garden City, NY 11530
MISOH misohlifestyle.com • Lot 102721

DIGITAL

6C

ITEM NO		96	240	480	960	2400	4800
U4521	Nasturtium	5.83	4.40	3.23	2.55	2.15	1.99
U4522	Borage	5.83	4.40	3.23	2.55	2.15	1.99
U4523	Calendula	5.83	4.40	3.23	2.55	2.15	1.99
U4524	Lavender	5.83	4.40	3.23	2.55	2.15	1.99
U4525	Viola	5.33	3.90	2.73	2.05	1.65	1.49
U4526	Cornflower	5.33	3.90	2.73	2.05	1.65	1.49

HERB SEEDS

Growing Fresh Herbs from Seeds

Greek Oregano

One of my absolute favorites in the herb garden is Greek oregano. It is savored for its strong aroma and spicy intense flavor and is prominently used in Greek, Italian, or Spanish cuisine in homemade pizzas, tomato sauces, soups, and more.

Genovese Basil

Genovese basil is grown for its many culinary uses. Fresh or dried, basil leaves are an essential ingredient in many Italian, Greek, and Asian dishes. They are perfect for making pesto or Caprese salad fresh from the garden. Edible Flowers

Sweet Marjoram

Growing marjoram is a great way to add both flavor and fragrance in the kitchen or garden. Marjoram plants are also great for attracting butterflies and other beneficial insects to the garden, making them ideal as companion plantings.

Italian Parsley

Italian parsley adds a fresh flavor and color that makes the dish. Growing Italian parsley in the garden or in a window box will allow you to harness the lively flavor of this plant. You can even use Italian parsley roots in salads or sautés.

Dill

Dill is a popular herb in the kitchen, flavoring everything from pickles to fish. Gourmets know that you can't beat fresh dill for the flavor. The best way to have the very freshest dill possible is by growing dill in your own garden.

Common Chive

Chives are a perennial member of the onion family with beautiful edible flowers. Plus, they're a wonderful companion plant that helps deter pests. Its grass-like hollow leaves have a mild onion flavor and are common in salads and dips.



U4541~4546

4" x 3 3/4"

Various Net Wt.

Specifications

Growing herbs from seeds is amazingly easy, even for the busy everyday person. By growing with your own seeds you can ensure that your food is as fresh and chemical free as possible. Why pay extra for farm-to-table fresh produce when you can bring the farm to your home for a fraction of the price?

- Free Setup / Art / Logos
- Bleeds Allowed on All Sides
- Fresh Packed upon Receipt of Order in USA

Material

Package : 8pt Gloss Cover

Printing

Digital : Full Color Printing on Front & Back

Die Cutting

No Charge for Standard Shape

Custom Shape, add \$150.00 (G) each shape

Option

Artwork Change : \$67.00 (G) each

Packaging : Bulk

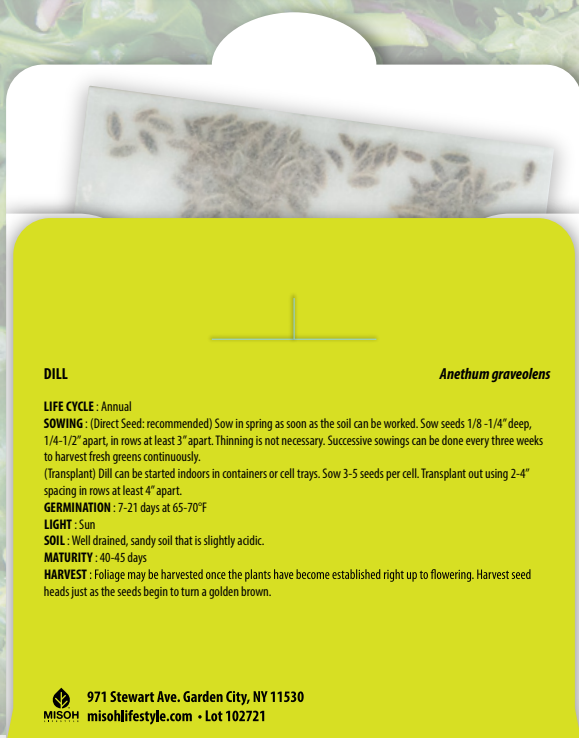

ITEM NO		96	240	480	960	2400	4800
U4541	Greek Oregano	5.33	3.90	2.73	2.05	1.65	1.49
U4542	Genovese Basil	5.33	3.90	2.73	2.05	1.65	1.49
U4543	Sweet Marjoram	5.33	3.90	2.73	2.05	1.65	1.49
U4544	Italian Parsley	5.33	3.90	2.73	2.05	1.65	1.49
U4545	Dill	5.33	3.90	2.73	2.05	1.65	1.49
U4546	Common Chive	5.33	3.90	2.73	2.05	1.65	1.49

NUTS



U4600~4605

2 1/2" x 1 3/4" (Tag)

2 1/2" x 2 x 5 1/2" (Bag)

Various Net Wt.



U4600 Cashews



U4601 Almonds



U4602 Hazelnuts



U4603 Pistachios



U4604 Walnuts



U4605 Pecans

6C

Nuts : Nutrition Powerhouse

Cashews

The cashew seed is commonly eaten on its own, used in recipes, or processed into cashew cheese or cashew butter. They've been linked to benefits like weight loss, improved blood sugar control, and a healthier heart.

Almonds

Almonds contain antioxidants, vitamins, minerals, protein, and fiber, and so they may offer a number of health benefits. People can eat almonds raw or toasted as a snack or add them to sweet or savory dishes.

Hazelnuts

Hazelnuts are rich in nutrients and have a high content of protein, fats, vitamins and minerals. It has a sweet flavor, make a tasty snack and a great addition to many dishes.

Pistachios

Pistachios are a type of tree nut with numerous health benefits including fats, protein, fiber, and antioxidants. What's more, they contain several essential nutrients and can aid weight loss and heart and gut health.

Walnuts

Walnuts are the only nut significantly high in omega-3 ALA. Omega-3s are essential fatty acids critical to various body processes. They may enhance heart and bone health and help in weight management, among other benefits.

Pecans

Pecans are a type of tree nut native to North America. They're a common ingredient in appetizers, desserts, and main dishes alike. This nutrient-dense nut boasts multiple vitamins, minerals and bio active compounds.

Specifications

Full Color Custom Packed Snacks. Wrapped up beautifully in a clear bag topped with a custom tag, you'll wow your customers before they even open the bag and get their first taste. Talk about the perfect gift.

- Free Setup / Art / Logos
- Bleeds Allowed on All Sides (Tag)
- Tag Printed in USA
- Fresh Packed upon Receipt of Order in USA

Material

Package : Bulk, 80# Gloss Cover, Clear Bag

Printing

Digital : Full Color Printing on Tag

Die Cutting

No Charge for Standard Package Shape
Custom Shape is Available, add
Custom Shape, add \$150.00 (G) each shape

Option

Artwork Change : \$67.00 (G) each

DIGITAL

ITEM NO		96	240	480	960	2400	4800
U4600	Cashews	13.14	12.20	11.89	11.73	11.63	11.60
U4601	Almonds	10.14	9.20	8.89	8.73	8.63	8.60
U4602	Hazelnuts	13.14	12.20	11.89	11.73	11.63	11.60
U4603	Pistachios	11.14	10.20	9.89	9.73	9.63	9.60
U4604	Walnuts	9.14	8.20	7.89	7.73	7.63	7.60
U4605	Pecans	12.14	11.20	10.89	10.73	10.63	10.60

DRIED FRUITS

Dried Fruits : Healthy Snacks

Dried Apples

Dried Apple Rings are a true snacker's favorite. They deliver chewy, apple goodness. Customers looking for better-for-you snacking options will be drawn to this sweet treat that still qualifies as a healthier choice.

Dried Pineapples

Sweet, tangy, and crisp, dried pineapple chunks make the perfect topping for ice cream, frozen yogurt or cereal. Customers will also love adding these sweet little morsels to their homemade trail mixes.

Dried Papayas

Finely diced and chewy dried papaya makes it easy to add a dash of the tropics to everything from yogurt parfaits, to freshly baked scones, to homemade trail mix.

Dried Cranberries

Popular for trail mixes, recipes, or just for snacking, these dried cranberries appeal to health-minded consumers, cooks, bakers, and chefs with their tart flavor and chewy texture.

Dried Kiwis

Our dried kiwis are an ideal choice as a snack, offering a great grab-and-go snack or a sweet addition to homemade trail mixes. Kiwis are low in fat, fairly low in calories and full of vitamins and minerals.

Golden Raisins

Golden Raisins are a popular snack choice for customers looking for a healthful option, and are of course, a popular baking ingredient and toppings bar favorite.



U4620~4625

2 1/2" x 1 3/4" (Tag)

2 1/2" x 2 x 5 1/2" (Bag)

Various Net Wt.



U4620 Dried Apples U4621 Dried Pineapples U4622 Dried Papayas



U4623 Dried Cranberries U4624 Dried Kiwis U4625 Golden Raisins

Specifications

Full Color Custom Packed Snacks. Wrapped up beautifully in a clear bag topped with a custom tag, you'll wow your customers before they ever open the bag and get their first taste. Talk about the perfect gift.

- Free Setup / Art / Logos
- Bleeds Allowed on All Sides (Tag)
- Tag Printed in USA
- Fresh Packed upon Receipt of Order in USA

Material

Package : Bulk, 80# Gloss Cover, Clear Bag

Printing

Digital : Full Color Printing on Tag

Die Cutting

No Charge for Standard Package Shape

Custom Shape is Available, add

Custom Shape, add \$150.00 (G) each shape

Option

Artwork Change : \$67.00 (G) each



DIGITAL

6C

ITEM NO		96	240	480	960	2400	4800
U4620	Dried Apples	7.14	6.20	5.89	5.73	5.63	5.60
U4621	Dried Pineapples	10.14	9.20	8.89	8.73	8.63	8.60
U4622	Dried Papayas	9.14	8.20	7.89	7.73	7.63	7.60
U4623	Dried Cranberries	9.14	8.20	7.89	7.73	7.63	7.60
U4624	Dried Kiwis	10.14	9.20	8.89	8.73	8.63	8.60
U4625	Golden Raisins	7.14	6.20	5.89	5.73	5.63	5.60

CHOCOLATES

Chocolates : Heavenly Delights

Mini Pretzels

Simple, bite-sized and delicious, these Milk Chocolate Mini Pretzels are just plain fun to eat. Not only are these morsels tasty on their own, they are small enough to include in snack mixes or goodie bags.

Andes Mints

Delivering the perfect bite-sized chocolate mint, Crème de Menthe is sandwiched between layers of chocolate to provide your customers with a delicious minty, chocolatey experience.

Jumbo Malt Balls

Our chocolate masters achieved a confectionery feat — enter the giant milk chocolate malted milk ball. Jumbo malt balls are appreciated for their crisp bite, smooth chocolate coating, and remarkable taste.

Cafe Latte Malt Balls

Much more than the traditional malt ball favorite, our gourmet café latte malt balls offer a delicious flavor profile to satisfy the most discerning palate with a classic crunch.

Dark Chocolate Raisins

The sweet taste of California raisins pairs well with rich, tart dark chocolate. Gourmet chocolate raisins are also at home in toppings bars and added to premium trail mix.

Cookie Dough Bites

Classic combination of cookie dough and chocolate is a tried and true flavor mashup that wins rave reviews. Perfect as an ice cream topping, enjoyed by the handful, or as a favorite trail mixes.



U4640~4645

2 ½" x 1 ¾" (Tag)

2 ½" x 2 x 5 ½" (Bag)

Various Net Wt.



U4640 Mini Pretzels



U4641 Andes Mints



U4642 Jumbo



U4643 Cafe Latte



U4644 Raisins



U4645 Cookie Dough

Specifications

Full Color Custom Packed Snacks. Wrapped up beautifully in a clear bag topped with a custom tag, you'll wow your customers before they ever open the bag and get their first taste. Talk about the perfect gift.

- Free Setup / Art / Logos
- Bleeds Allowed on All Sides (Tag)
- Tag Printed in USA
- Fresh Packed upon Receipt of Order in USA

Material

Package : Bulk, 80# Gloss Cover, Clear Bag

Printing

Digital : Full Color Printing on Tag

Die Cutting

No Charge for Standard Package Shape

Custom Shape is Available, add

Custom Shape, add \$150.00 (G) each shape

Option

Artwork Change : \$67.00 (G) each

DIGITAL

6C

ITEM NO		96	240	480	960	2400	4800
U4640	Mini Pretzels	9.14	8.20	7.89	7.73	7.63	7.60
U4641	Andes Mints	11.14	10.20	9.89	9.73	9.63	9.60
U4642	Jumbo Malt Balls	12.14	11.20	10.89	10.73	10.63	10.60
U4643	Cafe Latte Malt Balls	16.14	15.20	14.89	14.73	14.63	14.60
U4644	Dark Chocolate Raisins	15.14	14.20	13.89	13.73	13.63	13.60
U4645	Cookie Dough Bites	15.14	14.20	13.89	13.73	13.63	13.60

CANDIES

Candies : Sweet Carnival

Gummy Bears

Gummy Bears delight consumers with their bright colors, fruity flavors, and soft chew. A perennial favorite, gummy bears are a popular treat for all ages.

Fruit Barrels

Fruit Flavored Barrel Hard Candy in an assortment of orange, cherry, apple, lemon and grape flavors. Enjoy nostalgia with individually wrapped Fruit Flavored Barrel shaped hard candy.

Butterscotch Buttons

Butterscotch buttons appeal across all generations with their classic, smooth, buttery, sweet and slightly salty butterscotch flavor. These retro style hard candy treats are individually wrapped.

Caramel Squares

Individually wrapped caramel squares are traditional caramel candies with a buttery flavor and smooth texture your customers will appreciate. We enhanced the flavor of time-tested recipes that consumers prefer.

Starlight Mints

A minty fresh green and white candy that gets pocketed by the handful, Starlight Spearmint Mints are popular among customers looking for refreshing spearmint flavor.

Salt Water Taffy

Strawberry Banana Taffy is a combination of two of the most popular taffy flavors, coming together in a deliciously dynamic duo. Banana strawberry taffy will delight customers with their perfectly chewy, soft texture that is never sticky.



U4660~4665

2 ½" x 1 ¾" (Tag)

2 ½" x 2 x 5 ½" (Bag)

Various Net Wt.



U4660 Gummy Bears



U4661 Fruit Barrels



U4662 Butterscotch



U4663 Caramel Squares



U4664 Starlight Mints



U4665 Salt Water Taffy

Specifications

Full Color Custom Packed Snacks. Wrapped up beautifully in a clear bag topped with a custom tag, you'll wow your customers before they ever open the bag and get their first taste. Talk about the perfect gift.

- Free Setup / Art / Logos
- Bleeds Allowed on All Sides (Tag)
- Tag Printed in USA
- Fresh Packed upon Receipt of Order in USA

Material

Package : Bulk, 80# Gloss Cover, Clear Bag

Printing

Digital : Full Color Printing on Tag

Die Cutting

No Charge for Standard Package Shape

Custom Shape is Available, add

Custom Shape, add \$150.00 (G) each shape

Option

Artwork Change : \$67.00 (G) each



DIGITAL

6C

ITEM NO		96	240	480	960	2400	4800
U4660	Gummy Bears	9.14	8.20	7.89	7.73	7.63	7.60
U4661	Fruit Barrels	8.14	7.20	6.89	6.73	6.63	6.60
U4662	Butterscotch Buttons	11.14	10.20	9.89	9.73	9.63	9.60
U4663	Caramel Squares	16.14	15.20	14.89	14.73	14.63	14.60
U4664	Starlight Mints	8.14	7.20	6.89	6.73	6.63	6.60
U4665	Salt Water Taffy	8.14	7.20	6.89	6.73	6.63	6.60

custom LABELS/DECALS

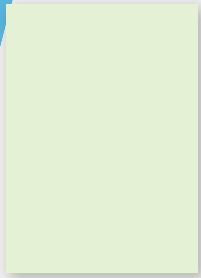

Shape 01

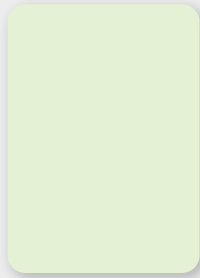

Shape 02



Shape 03

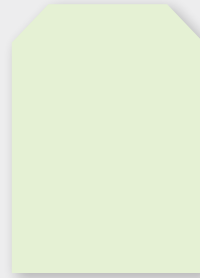

Shape 04

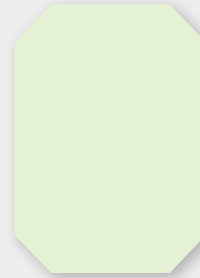

Shape 05



Shape 06

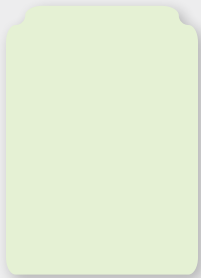

Shape 07

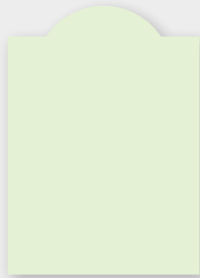

Shape 08



Shape 09



Shape 10



Shape 11



Shape 12

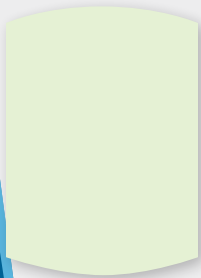

Shape 13



Shape 14



Shape 15

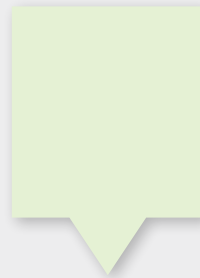

Shape 16



Shape 17



Shape 18

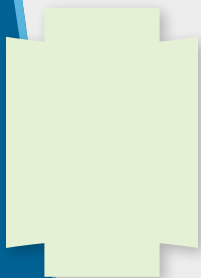

Shape 19

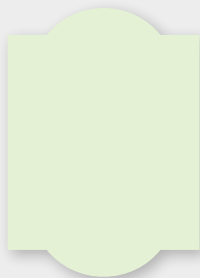

Shape 20

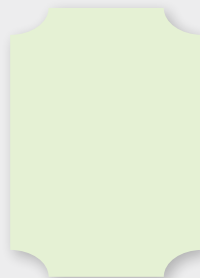

Shape 21



Shape 22



Shape 23



Shape 24



Shape 25



Shape 26



Shape 27



Shape 28

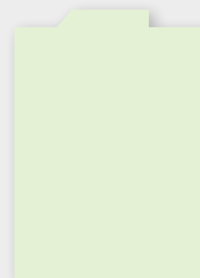

Shape 29



Shape 30



Shape 31



Shape 32



Shape 33



Shape 34



Shape 35



Shape 36



Shape 37



Shape 38



Shape 39



Shape 40

You can order any size not stated in the available sizes.
Price applies to the next larger size item that fits your size.



DIGITAL

7C

ITEM NO		100	250	500	1000	2500	5000	10000
U5010	One Side	1.09	0.51	0.32	0.23	0.17	0.15	0.14
U5011	One Side	1.13	0.55	0.36	0.26	0.20	0.18	0.18
U5012	One Side	1.17	0.60	0.40	0.31	0.25	0.23	0.22
U5013	One Side	1.21	0.63	0.44	0.35	0.29	0.27	0.23
U5014	One Side	1.27	0.69	0.50	0.40	0.35	0.33	0.25
U5015, 5016	One Side	1.34	0.76	0.57	0.47	0.42	0.40	0.27
U5017	One Side	1.40	0.82	0.63	0.54	0.48	0.46	0.28
U5018	One Side	1.42	0.84	0.65	0.56	0.50	0.48	0.29
U5019, 5020	One Side	1.49	0.91	0.72	0.63	0.57	0.49	0.31
U5021, 5022	One Side	1.61	1.03	0.84	0.75	0.69	0.53	0.35
U5023	One Side	1.81	1.23	1.04	0.95	0.89	0.61	0.43
U5024	One Side	2.04	1.47	1.28	1.19	1.06	0.69	0.51
U5025	One Side	2.42	1.85	1.67	1.57	1.22	0.85	0.67
U5026	One Side	3.56	2.99	2.80	2.71	1.71	1.33	1.15
ITEM NO		100	250	500	1000	2500	5000	10000
U5050	One Side	1.10	0.52	0.33	0.23	0.17	0.15	0.14
U5051	One Side	1.14	0.56	0.36	0.27	0.21	0.19	0.18
U5052	One Side	1.18	0.61	0.41	0.32	0.26	0.24	0.23
U5053	One Side	1.22	0.64	0.45	0.36	0.30	0.28	0.27
U5054	One Side	1.28	0.70	0.51	0.41	0.36	0.34	0.33
U5055, 5056	One Side	1.36	0.78	0.58	0.49	0.43	0.41	0.41
U5057	One Side	1.42	0.84	0.65	0.56	0.50	0.48	0.47
U5058	One Side	1.44	0.86	0.67	0.58	0.52	0.50	0.49
U5059, 5060	One Side	1.52	0.94	0.75	0.65	0.60	0.58	0.57
U5061, 5062	One Side	1.64	1.06	0.87	0.78	0.72	0.70	0.70
U5063	One Side	1.86	1.28	1.09	1.00	0.94	0.92	0.92
U5064	One Side	2.11	1.54	1.35	1.25	1.20	1.18	1.17
U5065	One Side	2.52	1.95	1.76	1.67	1.61	1.60	1.59
U5066	One Side	3.75	3.19	3.00	2.90	2.85	2.84	2.83

AVAILABLE SIZES

U5010/50	1" x 1"	U5018/58	2 1/2" x 3 1/4"
U5011/51	1" x 1 1/2"	U5019/59	1 3/4" x 5"
U5012/52	1 1/2" x 1 1/2"	U5020/60	2 1/2" x 4"
U5013/53	1 3/4" x 1 3/4"	U5021/61	2 1/2" x 5 1/4"
U5014/54	1 3/4" x 2 1/2"	U5022/62	3" x 4"
U5015/55	1 3/4" x 3 1/4"	U5023/63	4" x 5"
U5016/56	2 1/2" x 2 1/2"	U5024/64	3" x 8"
U5017/57	1 3/4" x 4"	U5025/65	5" x 8"
		U5026/66	8" x 10 3/4"

Specifications

Full Color Labels. Multiple ups on 8 1/2" x 11" Sheets.

- Free Setup / Art / Logos
- Bleeds Allowed on All Sides
- No Die Charge on Standard Shapes
- No Overrun Charge
- Indoor Applications
- Available in Forty Standard Shapes
- Made in USA

Material (Permanent Adhesive)

U5010~5026 : 60# White Semi-Gloss Paper

U5050~5066 : 4 mil White Matte Vinyl

Printing

Digital : Full Color Printing on One Side

Custom Shape

Custom Shape Available, add

Custom Shape : \$150.00 (G) each shape

Option

Artwork Change : \$37.00 (G) each

paper DOOR HANGERS

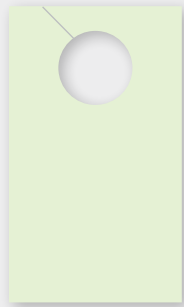

U5130-01
3 1/2" x 6"

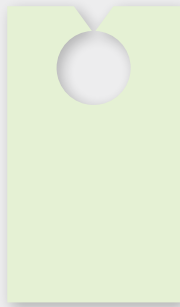

U5130-02
3 1/2" x 6"

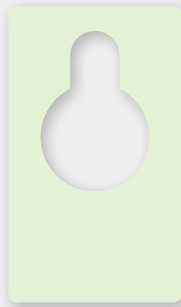

U5130-03
3 1/2" x 6"



U5130-04
3 1/2" x 6"



U5130-05
3 1/2" x 6"

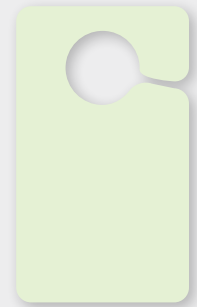

U5130-06
3 1/2" x 6"

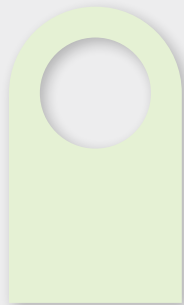

U5130-07
3 1/2" x 6"



U5130-08
3 1/2" x 6"



U5130-09
3 1/2" x 6"



U5130-10
3 1/2" x 6"



U5130-11
3 1/2" x 6"



U5130-12
3 1/2" x 6"



U2130-13
3 1/2" x 6"



U5130-14
3 1/2" x 6"

For U2132
Shape 1 to 8 comes with Business Card holder at Bottom.



AVAILABLE SIZES

U5130 3 1/2" x 6"

U5131 3 1/2" x 8 1/2"

U5132 4 1/8" x 11 1/4"

Specifications

- Full Color Door Hangers on Coated Stock.
- Free Setup / Art / Logos
- Bleeds Allowed on All Sides
- No Die Charge on Standard Shapes
- No Overrun Charge
- Two Separate Artworks for Front & Back Allowed
- Available in Fourteen Standard Shapes
- Made in USA

Material

U5130~5132 : 111# Gloss Cover

Printing

Digital : Full Color Printing on One / Two Side(s)

Custom Shape

No Charge for Standard Shapes / Square Corners / Circles

Custom Shape Available, add

Custom Shape : \$150.00 (G) each shape

Option

Artwork Change : \$37.00 (G) each



16C

ITEM NO		50	100	150	200	250	300	350	400
U5130	One Side	2.85	1.90	1.58	1.42	1.33	1.27	1.22	1.19
	Two Sides	3.41	2.30	1.92	1.74	1.63	1.55	1.50	1.46
U5131	One Side	3.01	2.06	1.75	1.59	1.50	1.43	1.39	1.35
	Two Sides	3.62	2.50	2.13	1.94	1.83	1.76	1.71	1.67
U5132	One Side	3.40	2.45	2.13	1.97	1.88	1.82	1.77	1.74
	Two Sides	4.13	3.02	2.65	2.46	2.35	2.28	2.23	2.19
ITEM NO		500	750	1000	1500	2500	5000	7500	10000
U5130	One Side	1.14	1.08	1.05	0.94	0.60	0.35	0.27	0.23
	Two Sides	1.41	1.33	1.29	1.26	0.85	0.48	0.36	0.30
U5131	One Side	1.31	1.24	1.21	0.96	0.62	0.37	0.29	0.25
	Two Sides	1.61	1.54	1.40	0.98	0.64	0.39	0.30	0.26
U5132	One Side	1.69	1.63	1.43	1.01	0.68	0.43	0.35	0.30
	Two Sides	2.13	1.89	1.47	1.04	0.70	0.45	0.37	0.32

DOOR HANGERS plastic

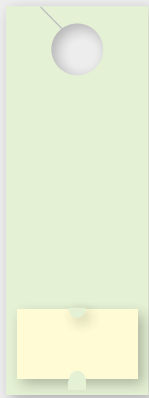

U5142-01
4 1/8" x 11 1/4"

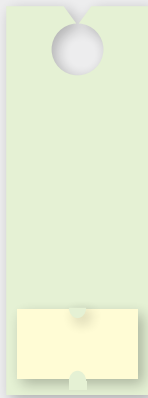

U5142-02
4 1/8" x 11 1/4"

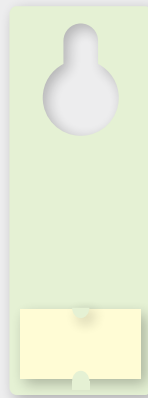

U5142-03
4 1/8" x 11 1/4"

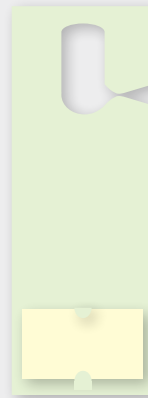

U5142-04
4 1/8" x 11 1/4"

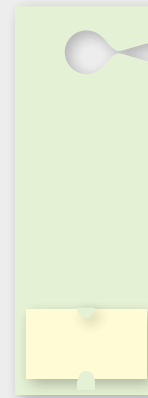

U5142-05
4 1/8" x 11 1/4"

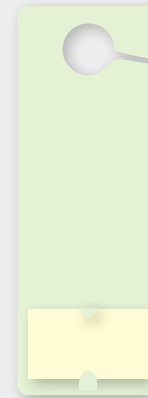

U5142-06
4 1/8" x 11 1/4"

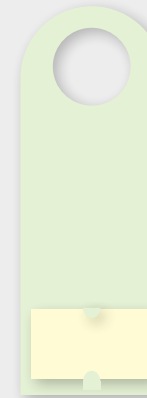

U5142-07
4 1/8" x 11 1/4"

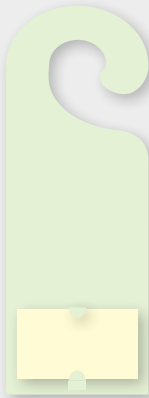

U5142-08



U5142-09



U5142-10



U5142-11



U5142-12



U5142-13

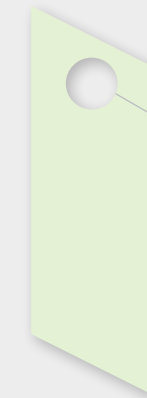

U5142-14

AVAILABLE SIZES

U5140 3 1/2" x 6"

U5141 3 1/2" x 8 1/2"

U5142 4 1/8" x 11 1/4"

For U5142

Shape 1 to 8 comes with Business Card holder at Bottom.

Specifications

Full Color Door Hangers on Durable Plastic.

- Free Setup / Art / Logos
- Bleeds Allowed on All Sides
- No Die Charge on Standard Shapes
- No Ovrerrun Charge
- Two Separate Artworks for Front & Back Allowed
- Available in One Thickness
- Available in Fourteen Standard Shapes
- Made in USA

Material

U5140~5142 : 10 mil PVC

Printing

Digital : Full Color Printing on One / Two Side(s)

Custom Shape

Custom Shape Available, add

Custom Shape : \$150.00 (G) each shape

Option

Artwork Change : \$37.00 (G) each



DIGITAL

16C

ITEM NO		50	100	150	200	250	300	350	400
U5140	One Side	3.16	2.19	1.87	1.71	1.61	1.55	1.51	1.47
	Two Sides	3.72	2.59	2.21	2.02	1.91	1.84	1.79	1.75
U5141	One Side	3.37	2.40	2.08	1.92	1.83	1.77	1.72	1.69
	Two Sides	3.97	2.84	2.46	2.28	2.17	2.09	2.04	2.00
U5142	One Side	3.91	2.95	2.63	2.47	2.38	2.32	2.27	2.24
	Two Sides	4.65	3.52	3.15	2.96	2.85	2.78	2.73	2.69
ITEM NO		500	750	1000	1500	2500	5000	7500	10000
U5140	One Side	1.42	1.36	1.33	1.30	1.27	1.25	1.25	1.25
	Two Sides	1.69	1.62	1.58	1.54	1.51	1.49	1.48	1.48
U5141	One Side	1.64	1.58	1.54	1.51	1.49	1.47	1.47	1.46
	Two Sides	1.94	1.87	1.83	1.80	1.77	1.74	1.74	1.73
U5142	One Side	2.19	2.13	2.10	2.06	2.04	2.02	2.02	2.01
	Two Sides	2.63	2.56	2.52	2.48	2.45	2.43	2.42	2.42

BOOK MARKS

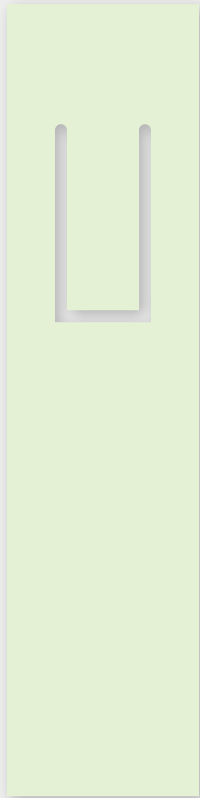

Shape 01
2" x 8 1/4"

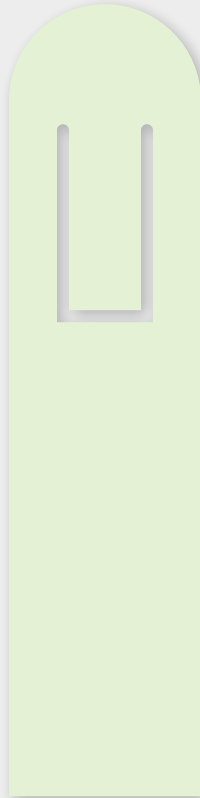

Shape 02
2" x 8 1/4"

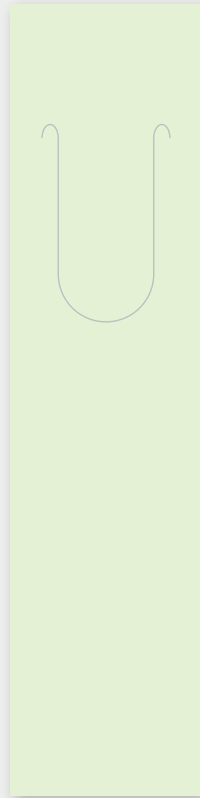

Shape 03
2" x 8 1/4"

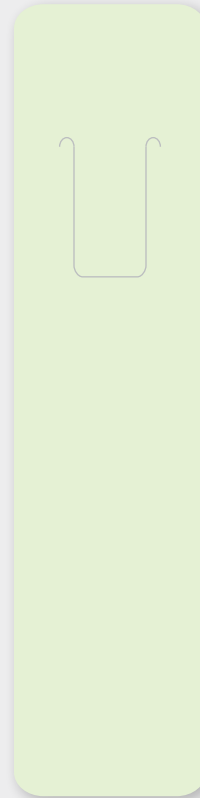

Shape 04
2" x 8 1/4"

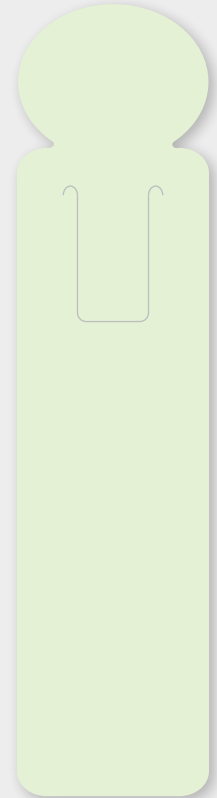

Shape 05
2" x 8 1/4"

AVAILABLE ITEMS

U5160 (15 pt Cover)

U5165 (10 mil PVC)

U5166 (20 mil PVC)



DIGITAL

16C

ITEM NO		50	100	150	200	250	300	350	400
U5160	One Side	2.83	1.88	1.57	1.41	1.31	1.25	1.20	1.17
	Two Sides	3.33	2.21	1.84	1.65	1.54	1.47	1.41	1.37
U5165	One Side	3.05	2.08	1.76	1.60	1.50	1.44	1.40	1.36
	Two Sides	3.55	2.41	2.03	1.84	1.73	1.66	1.61	1.57
U5166	One Side	3.22	2.23	1.91	1.74	1.65	1.59	1.54	1.51
	Two Sides	3.71	2.56	2.18	1.99	1.88	1.80	1.75	1.71
ITEM NO		500	750	1000	1500	2500	5000	7500	10000
U5160	One Side	1.12	1.06	1.03	0.93	0.59	0.33	0.25	0.20
	Two Sides	1.32	1.25	1.21	0.95	0.60	0.34	0.26	0.21
U5165	One Side	1.32	1.25	1.22	1.19	1.16	1.15	1.14	1.14
	Two Sides	1.51	1.44	1.40	1.36	1.33	1.31	1.30	1.30
U5166	One Side	1.46	1.40	1.37	1.33	1.31	1.29	1.29	1.28
	Two Sides	1.66	1.58	1.54	1.51	1.48	1.46	1.45	1.45

Specifications

Full Color Book Marks on Coated Stock or Durable Plastic.

- Free Setup / Art / Logos
- Bleeds Allowed on All Sides
- No Die Charge on Standard Shapes
- No Overrun Charge
- Two Separate Artworks for Front & Back Allowed
- Available in Five Standard Shapes
- Made in USA

Material

U5160 : 130# Gloss Cover

U5165 : 10 mil PVC

U5166 : 20 mil PVC

Printing

Digital : Full Color Printing on One / Two Side(s)

Custom Shape

Custom Shape Available, add

Custom Shape : \$150.00 (G) each shape

Option

Artwork Change : \$37.00 (G) each

GLASS MARKERS



U5220-01 (Paper)
U5225-01 (Plastic)
2 5/8" x 2 5/8"



U5220-02 (Paper)
U5225-02 (Plastic)
2 5/8" x 2 5/8"

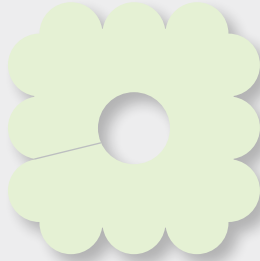

U5220-03 (Paper)
U5225-03 (Plastic)
2 5/8" x 2 5/8"

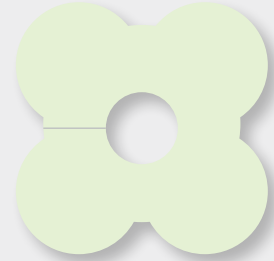

U5220-04 (Paper)
U5225-04 (Plastic)
2 5/8" x 2 5/8"

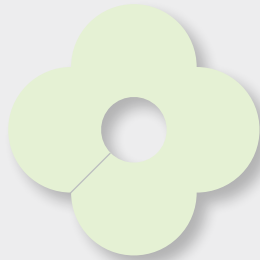

U5220-05 (Paper)
U5225-05 (Plastic)
2 5/8" x 2 5/8"

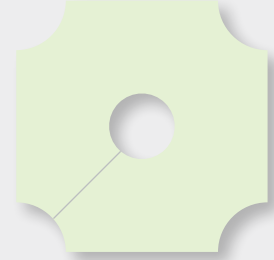

U5220-06 (Paper)
U5225-06 (Plastic)
2 5/8" x 2 5/8"



Specifications

Full Color Glass Markers on Paper or Plastic Stock.

- Free Setup / Art / Logos
- Bleeds Allowed on All Sides
- No Die Charge on Standard Shapes
- No Overrun Charge
- Available in Two Materials
- Available in Five Standard Shapes
- Made in USA

Material

U5220 : 111# Gloss Cover

U5225 : 10 mil PVC

Printing

Digital : Full Color Printing on One Side

Custom Shape

Custom Shape Available, add

Custom Shape : \$150.00 (G) each shape

Option

Artwork Change : \$37.00 (G) each



DIGITAL

16C

ITEM NO		50	100	150	200	250	300	350	400
U5220	One Side	2.33	1.38	1.07	0.91	0.81	0.75	0.70	0.67
U5225	One Side	2.45	1.48	1.16	1.00	0.90	0.83	0.79	0.75
ITEM NO		500	750	1000	1500	2500	5000	7500	10000
U5220	One Side	0.62	0.56	0.53	0.50	0.47	0.28	0.20	0.15
U5225	One Side	0.71	0.64	0.61	0.58	0.55	0.54	0.53	0.53

plastic MENUS

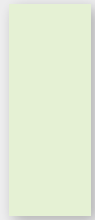

U5240-01
4 1/4" x 11"

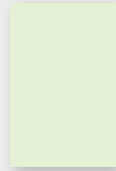

U5240-02
5 1/2" x 8 1/2"

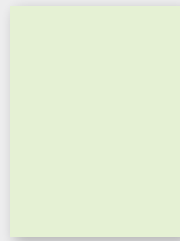

U5241
9" x 12"

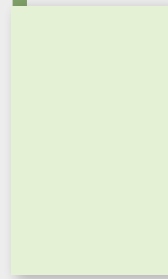

U5242
8 1/2" x 14"

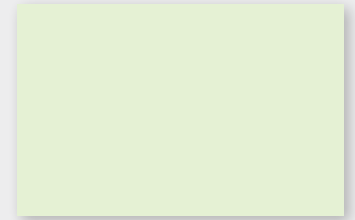

U5243
17" x 11"

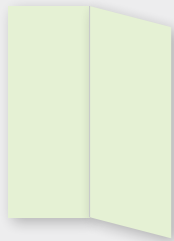

U5244-01
4 1/4" x 11"



U5244-02
5 1/2" x 8 1/2"



U5245
9" x 12"



U5246
4" x 8 1/2"

U5247
6" x 11"

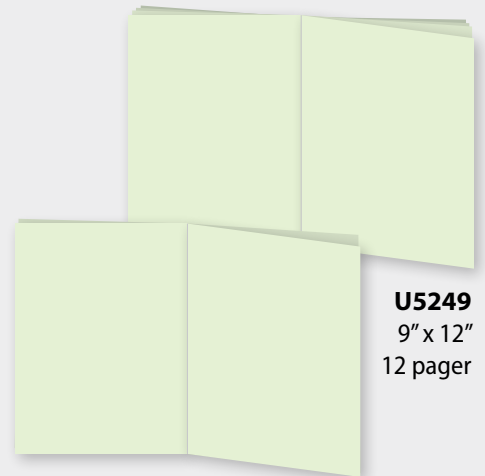

U5248
9" x 12" 8 pager

U5249
9" x 12"
12 pager



DIGITAL

16C

ITEM NO		50	100	150	200	250	300	350	400
U5240	Single	2.94	2.15	1.89	1.76	1.68	1.63	1.59	1.56
U5241	Single	4.30	3.52	3.26	3.13	3.05	3.00	2.96	2.94
U5242	Single	7.04	6.26	6.00	5.87	5.79	5.74	5.70	5.68
U5243	Single	7.04	6.26	6.00	5.87	5.79	5.74	5.70	5.68
U5244	Bifold	4.30	3.52	3.26	3.13	3.05	3.00	2.96	2.94
U5245	Bifold	7.04	6.26	6.00	5.87	5.79	5.74	5.70	5.68
U5246	Trifold	4.30	3.52	3.26	3.13	3.05	3.00	2.96	2.94
U5247	Trifold	7.04	6.26	6.00	5.87	5.79	5.74	5.70	5.68
U5248	8 Pages	15.53	13.42	12.72	12.36	12.15	12.01	11.91	11.84
U5249	12 Pages	22.17	19.73	18.91	18.50	18.26	18.10	18.03	17.93

ITEM NO		500	750	1000	1500	2500	5000	7500	10000
U5240	Single	1.53	1.47	1.45	1.42	1.40	1.39	1.38	1.38
U5241	Single	2.90	2.84	2.82	2.79	2.78	2.76	2.76	2.76
U5242	Single	5.64	5.58	5.56	5.54	5.53	5.51	5.51	5.50
U5243	Single	5.64	5.58	5.56	5.54	5.53	5.51	5.51	5.50
U5244	Bifold	2.90	2.84	2.82	2.79	2.78	2.76	2.76	2.76
U5245	Bifold	5.64	5.58	5.56	5.54	5.53	5.51	5.51	5.50
U5246	Trifold	2.90	2.84	2.82	2.79	2.78	2.76	2.76	2.76
U5247	Trifold	5.64	5.58	5.56	5.54	5.53	5.51	5.51	5.50
U5248	8 Pages	11.73	11.61	11.54	11.47	11.42	11.38	11.37	11.36
U5249	12 Pages	17.80	17.65	17.56	17.49	17.43	17.38	17.36	17.35

Specifications

Full Color Menus on Washable Synthetic Paper.

- Free Setup / Art / Logos
- Bleeds Allowed on All Sides
- No Overrun Charge
- Two Separate Artworks for Front & Back Allowed
- Available in One Thickness
- Available in Ten Standard Sizes
- More Durable than Paper
- Made in USA

Material

U5240~U5249 : 10 mil Synthetic

Printing

Digital : Full Color Printing on Two Sides

Custom Shape

No Custom Shape

Option

Artwork Change : \$67.00 (G) each

SHELF WOBBLERS



U5360-01
3" Round
3" x 6 1/2"



U5361-01
4" Round
4" x 8"



U5362-01
4" x 3" Oval
4" x 6 1/2"



U5363-01
5" x 3 1/4" Oval
5" x 7 1/4"

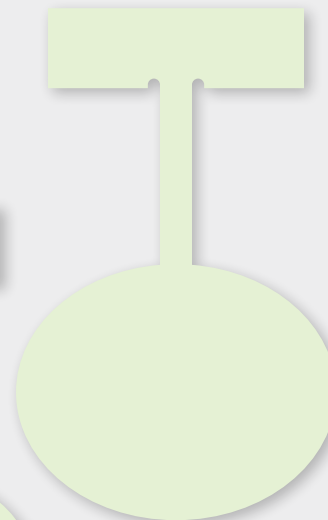

U5364-01
5" x 4" Oval
5" x 8"



U5360-02



U5361-02



U5362-02



U5363-02



U5364-02

Specifications

Full Color Shelf Wobblers on Durable Plastic.

- Free Setup / Art / Logos
- Bleeds Allowed on All Sides
- No Die Charge on Standard Shapes
- No Overtime Charge
- Available in One Thickness
- Available in Two Standard Shapes
- Double-side Tape Pre-applied
- Made in USA

Material

U5360~5364 : 10 mil PVC

Printing

Digital : Full Color Printing on One Side

Custom Shape

Custom Shape Available, add

Custom Shape : \$150.00 (G) each shape

Option

Artwork Change : \$37.00 (G) each



DIGITAL

16C

ITEM NO		50	100	150	200	250	300	350	400
U5360	One Side	4.33	3.19	2.81	2.63	2.52	2.44	2.39	2.35
U5361	One Side	4.89	3.75	3.38	3.19	3.08	3.01	2.95	2.91
U5362	One Side	5.09	3.95	3.58	3.40	3.28	3.21	3.16	3.12
U5363	One Side	5.45	4.31	3.94	3.76	3.65	3.57	3.52	3.48
U5364	One Side	5.68	4.55	4.18	4.00	3.89	3.81	3.76	3.72
ITEM NO		500	750	1000	1500	2500	5000	7500	10000
U5360	One Side	2.29	2.22	2.18	2.14	2.12	2.09	2.09	2.08
U5361	One Side	2.86	2.78	2.75	2.71	2.68	2.66	2.65	2.65
U5362	One Side	3.06	2.99	2.95	2.91	2.88	2.86	2.86	2.85
U5363	One Side	3.43	3.35	3.31	3.28	3.25	3.23	3.22	3.22
U5364	One Side	3.67	3.59	3.55	3.52	3.49	3.47	3.46	3.46

HANGING PERMITS

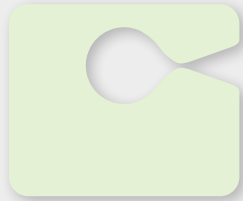

U5370/80
3" x 2 1/2"



U5371/81
3" x 3 1/4"

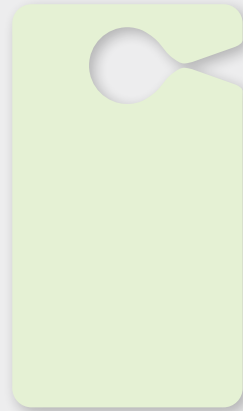

U5374/84
3" x 5 1/4"

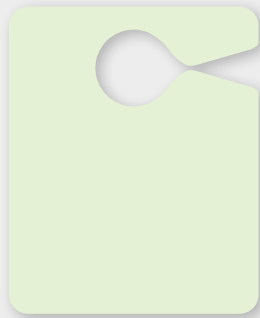

U5373/83
3 1/4" x 4"

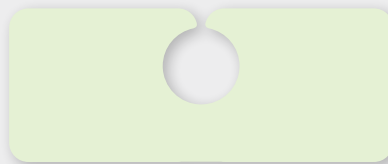

U5372/82
5" x 2"

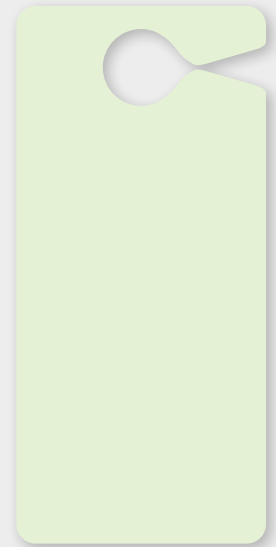

U5375/85
3 1/4" x 7"



DIGITAL

7C

ITEM NO		100	250	500	1000	2500	5000	10000
U5370	One Side	1.41	0.84	0.65	0.56	0.50	0.29	0.17
	Two Sides	1.66	0.99	0.77	0.65	0.59	0.42	0.23
U5371	One Side	1.48	0.91	0.72	0.63	0.56	0.31	0.18
	Two Sides	1.76	1.09	0.86	0.75	0.69	0.43	0.24
U5372	One Side	1.50	0.93	0.74	0.65	0.57	0.31	0.18
	Two Sides	1.79	1.12	0.89	0.78	0.71	0.44	0.25
U5373	One Side	1.57	1.00	0.81	0.72	0.58	0.32	0.19
	Two Sides	1.87	1.20	0.98	0.87	0.59	0.33	0.20
U5374	One Side	1.65	1.08	0.89	0.80	0.59	0.33	0.20
	Two Sides	1.98	1.31	1.09	0.98	0.84	0.46	0.27
U5375	One Side	1.84	1.27	1.08	0.99	0.62	0.37	0.24
	Two Sides	2.24	1.57	1.35	1.24	0.87	0.50	0.31
ITEM NO		100	250	500	1000	2500	5000	10000
U5380	One Side	1.60	1.01	0.82	0.72	0.67	0.65	0.64
	Two Sides	1.85	1.16	0.93	0.82	0.76	0.73	0.72
U5381	One Side	1.73	1.14	0.95	0.85	0.80	0.78	0.77
	Two Sides	2.00	1.31	1.09	0.98	0.91	0.89	0.88
U5382	One Side	1.76	1.17	0.98	0.89	0.83	0.81	0.81
	Two Sides	2.05	1.36	1.13	1.02	0.95	0.93	0.92
U5383	One Side	1.87	1.28	1.09	1.00	0.94	0.92	0.91
	Two Sides	2.17	1.48	1.26	1.15	1.08	1.06	1.05
U5384	One Side	2.00	1.42	1.23	1.13	1.08	1.06	1.05
	Two Sides	2.33	1.64	1.42	1.31	1.24	1.22	1.21
U5385	One Side	2.33	1.75	1.56	1.47	1.41	1.40	1.39
	Two Sides	2.73	2.05	1.83	1.72	1.65	1.63	1.62

Specifications

Full Color Hanging Permits on Paper or Plastic.

- Free Setup / Art / Logos
- Bleeds Allowed on All Sides
- No Die Charge on Standard Shapes
- No Ovrerrun Charge
- Two Separate Artworks for Front & Back Allowed
- Available in Six Standard Shapes
- Made in USA

Material

U5370~5375 : 130# Gloss Cover

U5380~5385 : 20 mil PVC

Printing

Digital : Full Color Printing on One / Two Side(s)

Custom Shape

Custom Shape Available, add

Custom Shape : \$150.00 (G) each shape

Option

Artwork Change : \$37.00 (G) each

HANG TAGS

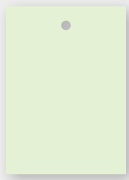

Shape 01

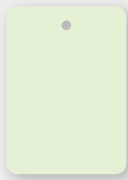

Shape 02



Shape 03

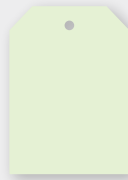

Shape 04

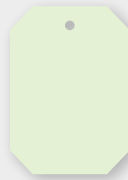

Shape 05



Shape 06

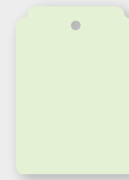

Shape 07

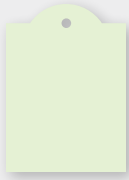

Shape 08



Shape 09



Shape 10



Shape 11



Shape 12

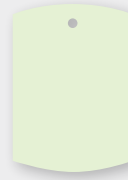

Shape 13



Shape 14



Shape 15

You can order any size not stated in the available sizes.
Price applies to the next larger size item that fits your size.



DIGITAL

7C

ITEM NO		100	250	500	1000	2500	5000	10000
U5430	Two Sides	1.31	0.63	0.41	0.30	0.23	0.21	0.19
U5431	Two Sides	1.35	0.68	0.46	0.34	0.28	0.25	0.19
U5432	Two Sides	1.40	0.73	0.50	0.39	0.32	0.30	0.19
U5433, 5434	Two Sides	1.42	0.75	0.53	0.41	0.35	0.33	0.19
U5435	Two Sides	1.43	0.75	0.53	0.42	0.35	0.33	0.30
U5436	Two Sides	1.45	0.77	0.55	0.44	0.37	0.35	0.19
U5437, 5438	Two Sides	1.50	0.83	0.60	0.49	0.42	0.40	0.30
U5439	Two Sides	1.47	0.80	0.57	0.46	0.39	0.35	0.19
U5440	Two Sides	1.49	0.81	0.59	0.47	0.41	0.38	0.30
U5441	Two Sides	1.53	0.85	0.62	0.51	0.44	0.42	0.30
U5442, 5443	Two Sides	1.55	0.87	0.65	0.53	0.47	0.44	0.30
U5444	Two Sides	1.59	0.91	0.68	0.57	0.50	0.48	0.30
U5445	Two Sides	1.66	0.98	0.75	0.64	0.57	0.55	0.30
ITEM NO		100	250	500	1000	2500	5000	10000
U5470	Two Sides	1.37	0.69	0.46	0.35	0.28	0.26	0.25
U5471	Two Sides	1.46	0.78	0.56	0.44	0.38	0.35	0.34
U5472	Two Sides	1.56	0.88	0.65	0.54	0.47	0.45	0.44
U5473, 5474	Two Sides	1.63	0.95	0.72	0.61	0.54	0.52	0.51
U5475	Two Sides	1.22	0.70	0.53	0.45	0.40	0.38	0.38
U5476	Two Sides	1.70	1.02	0.79	0.68	0.61	0.59	0.58
U5477, 5478	Two Sides	1.78	1.10	0.87	0.76	0.69	0.67	0.66
U5479	Two Sides	1.79	1.11	0.89	0.78	0.71	0.69	0.68
U5480	Two Sides	1.83	1.15	0.92	0.81	0.74	0.72	0.71
U5481	Two Sides	1.89	1.21	0.99	0.87	0.81	0.79	0.77
U5482, 5483	Two Sides	1.98	1.30	1.08	0.97	0.90	0.88	0.87
U5484	Two Sides	2.11	1.43	1.21	1.10	1.03	1.01	1.00
U5485	Two Sides	2.42	1.75	1.52	1.41	1.35	1.32	1.32

AVAILABLE SIZES

U5430/70	1 1/2" x 1 1/2"	U5437/77	1 1/2" x 5 1/2"
U5431/71	2" x 2"	U5438/78	2 1/2" x 3 1/2"
U5432/72	1 1/2" x 3 1/2"	U5439/79	2 1/2" x 4"
U5433/73	1 1/2" x 4"	U5440/80	3 1/4" x 3 1/2"
U5434/74	2 1/2" x 2 1/2"	U5441/81	2" x 5 1/2"
U5435/75	2" x 3 1/2"	U5442/82	2 1/2" x 5 1/2"
U5436/76	2" x 4"	U5443/83	3 1/2" x 4"
		U5444/84	3 1/4" x 5 1/2"
		U5445/85	3 1/4" x 7"

Specifications

Full Color Hang Tags on Coated Stock.

- Free Setup / Art / Logos
- Bleeds Allowed on All Sides
- No Die Charge on Standard Shapes
- No Overrun Charge
- Two Separate Artworks for Front & Back Allowed
- Available in One Thickness
- Available in Fifteen Standard Shapes
- Made in USA

Material

U5430~5445 : 130# Gloss Cover

U5470~5485 : 10 mil PVC

Printing

Digital : Full Color Printing on Two Sides

Custom Shape

Custom Shape Available, add

Custom Shape : \$150.00 (G) each shape

Option

Artwork Change : \$37.00 (G) each

sleeve FOLDING CARTONS

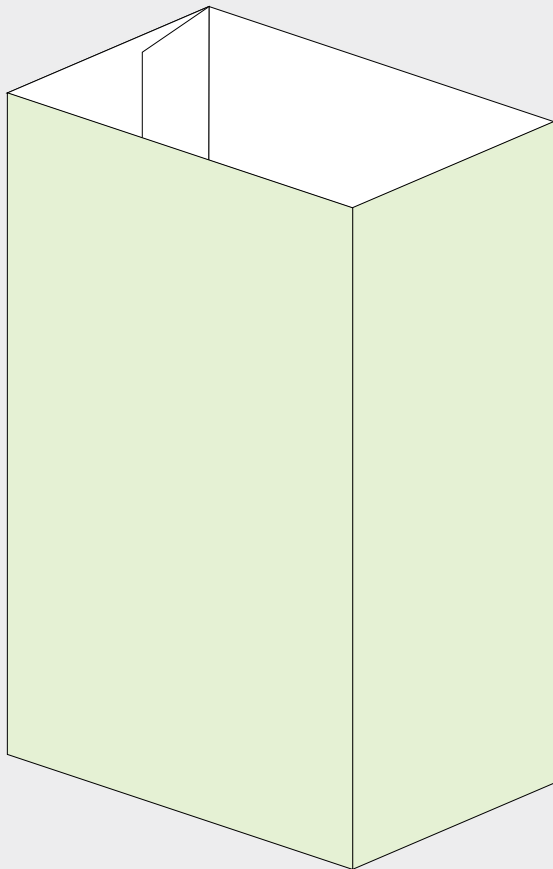

Shortrun Custom Cartons

- Open End Glued Sleeve
- Ideal for hard-to-package products
- Can be used as an overslip on a corrugated box
- Versatile, low cast solution

Locate Item number from the size table, then look for the price below!

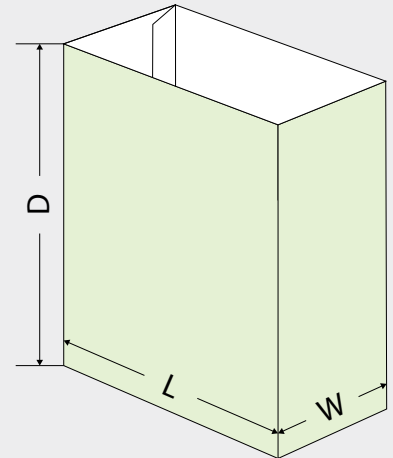

DIGITAL

16C

ITEM NO		50	100	150	200	250	300	350	400
U5510	One Side	5.53	3.24	2.48	2.10	1.87	1.72	1.61	1.53
U5511	One Side	5.73	3.45	2.69	2.31	2.08	1.93	1.82	1.74
U5512	One Side	5.94	3.65	2.89	2.51	2.28	2.13	2.02	1.94
U5513	One Side	6.16	3.88	3.11	2.73	2.51	2.35	2.25	2.16
U5514	One Side	6.35	4.07	3.31	2.93	2.70	2.55	2.44	2.36
U5515	One Side	6.97	4.69	3.93	3.55	3.32	3.17	3.06	2.98
U5516	One Side	7.59	5.31	4.55	4.17	3.95	3.79	3.69	3.60
U5517	One Side	8.41	6.14	5.38	5.00	4.77	4.62	4.51	4.43
U5518	One Side	9.90	7.62	6.87	6.49	6.26	6.11	6.00	5.55

ITEM NO		500	750	1000	1500	2500	5000	7500	10000
U5510	One Side	1.41	1.10	0.98	0.86	0.78	0.46	0.35	0.29
U5511	One Side	1.62	1.30	1.19	1.07	0.81	0.49	0.38	0.33
U5512	One Side	1.83	1.51	1.39	1.28	0.85	0.52	0.41	0.36
U5513	One Side	2.05	1.73	1.61	1.31	0.86	0.54	0.43	0.38
U5514	One Side	2.24	1.93	1.81	1.36	0.91	0.58	0.48	0.42
U5515	One Side	2.87	2.55	2.04	1.46	1.01	0.68	0.58	0.52
U5516	One Side	3.49	2.72	2.14	1.55	1.10	0.78	0.67	0.62
U5517	One Side	4.16	2.91	2.33	1.75	1.30	0.98	0.87	0.82
U5518	One Side	4.74	3.49	2.93	2.34	1.89	1.57	1.46	1.41

Specifications

Full Color Shortrun Custom Printed Folding Cartons

- Free Setup / Art / Logos
- Bleeds Allowed on All Sides
- No Die Charge on Standard Sizes
- No Ovrerrun Charge
- No Pre-fixed Sizes
- Made in USA

Material

U5510~5518 : 11.4 pt Gloss Cover

Printing

Digital : Full Color Printing on One Side

Custom Size

Custom Size Available, add

Custom Shape : \$50.00 (G) each custom size

Option

Dieline Design : no charge

No Print Sample : \$40.00 (G) for 2 pcs / dieline

Artwork Change : \$67.00 (G) each

ITEM NO	W	L	D	ITEM NO	W	L	D	ITEM NO	W	L	D	ITEM NO	W	L	D	
U5510	1	1	1		2	2	14		3	3	12	U5516	4	4	4	
	1	1	2		2	2	15		U5510	4	1	1	U5517	4	4	5
U5511	1	1	3	U5510	3	1	1	U5512	4	1	2		4	4	6	
U5512	1	1	4	U5511	3	1	2	U5514	4	1	3	U5518	4	4	7	
U5514	1	1	5	U5513	3	1	3	U5515	4	1	4		4	4	8	
	1	1	6	U5514	3	1	4	U5516	4	1	5		4	4	9	
U5515	1	1	7	U5515	3	1	5		4	1	6		4	4	10	
	1	1	8	3	1	6	U5517		4	1	7		4	4	11	
	1	1	9	U5517	3	1	7		4	1	8		4	4	12	
U5516	1	1	10		3	1	8		4	1	9	U5511	5	1	1	
	1	1	11		3	1	9		U5518	4	1	10	U5514	5	1	2
	1	1	12		3	1	10		4	1	11	U5515	5	1	3	
U5517	1	1	13		3	1	11		4	1	12	U5516	5	1	4	
	1	1	14		3	1	12		4	1	13	U5517	5	1	5	
	1	1	15		U5518	3	1		13	4	1	14	5	1	6	
U5510	2	1	1		3	1	14		4	1	15	U5518	5	1	7	
U5511	2	1	2		3	1	15		U5511	4	2	1	5	1	8	
U5513	2	1	3		U5510	3	2		1	U5514	4	2	2	5	1	9
U5514	2	1	4	U5512	3	2	2	U5515	4	2	3	5	1	10		
U5515	2	1	5	U5514	3	2	3	U5516	4	2	4	5	1	11		
	2	1	6	U5515	3	2	4	U5517	4	2	5	5	1	12		
U5517	2	1	7	U5516	3	2	5		4	2	6	U5511	5	2	1	
	2	1	8	3	2	6	U5518		4	2	7	U5514	5	2	2	
	2	1	9	U5517	3	2	7		4	2	8	U5515	5	2	3	
	2	1	10	3	2	8	4		2	9	U5516	5	2	4		
	2	1	11	3	2	9	4		2	10	U5517	5	2	5		
	2	1	12	U5518	3	2	10		4	2	11	5	2	6		
U5518	2	1	13		3	2	11		4	2	12	U5518	5	2	7	
	2	1	14		3	2	12		U5511	4	3	1	5	2	8	
	2	1	15		3	2	13		U5514	4	3	2	5	2	9	
U5510	2	2	1		3	2	14	U5515	4	3	3	5	2	10		
U5511	2	2	2		3	2	15	U5516	4	3	4	5	2	11		
U5513	2	2	3		U5511	3	3	1	U5517	4	3	5	5	2	12	
U5514	2	2	4	U5514	3	3	2		4	3	6	U5511	5	3	1	
U5515	2	2	5	U5515	3	3	3		U5518	4	3	7	U5514	5	3	2
	2	2	6	U5516	3	3	4	4	3	8	U5515	5	3	3		
U5517	2	2	7	U5517	3	3	5		4	3	9	U5516	5	3	4	
	2	2	8	3	3	6	4		3	10	U5517	5	3	5		
	2	2	9	U5518	3	3	7		4	3	11	5	3	6		
	2	2	10	3	3	8	4		3	12	U5518	5	3	7		
	2	2	11	3	3	9	U5511		4	4	1	5	3	8		
	2	2	12	3	3	10	U5514		4	4	2	5	3	9		
U5518	2	2	13	3	3	11	U5515	4	4	3	5	3	10			

Any in between size is possible!

ITEM NO	W	L	D
	5	3	11
	5	3	12
U5511	6	1	1
U5514	6	1	2
U5515	6	1	3
U5516	6	1	4
U5517	6	1	5
	6	1	6
U5518	6	1	7
	6	1	8
	6	1	9
	6	1	10
	6	1	11
	6	1	12
U5511	6	2	1
U5514	6	2	2
U5515	6	2	3
U5516	6	2	4
U5517	6	2	5
U5518	6	2	7
	6	2	8
	6	2	9
	6	2	10
	6	2	11
	6	2	12
U5511	7	1	1
U5514	7	1	2
U5515	7	1	3
U5516	7	1	4
U5517	7	1	5
	7	1	6
U5518	7	1	7
	7	1	8
	7	1	9
	7	1	10
	7	1	11
	7	1	12

Custom Folding Cartons : We offer high quality full custom folding cartons. Our minimum starts at 50 boxes. Industry's lowest! No die charge and Free Setup! You can order any in between size not stated in the size table. Price applies to the next larger size item that fits your size.

Need a Larger Size or Quantity not Listed? For larger sizes, quantities, or thicker stock, please contact factory for a quote! We are capable of producing folding cartons up to 40 pt thick and larger sizes not listed here. Numerous finishes including embossing/debossing, aqueous coating, UV coating, and foil stamping can be added also.

tuck end FOLDING CARTONS

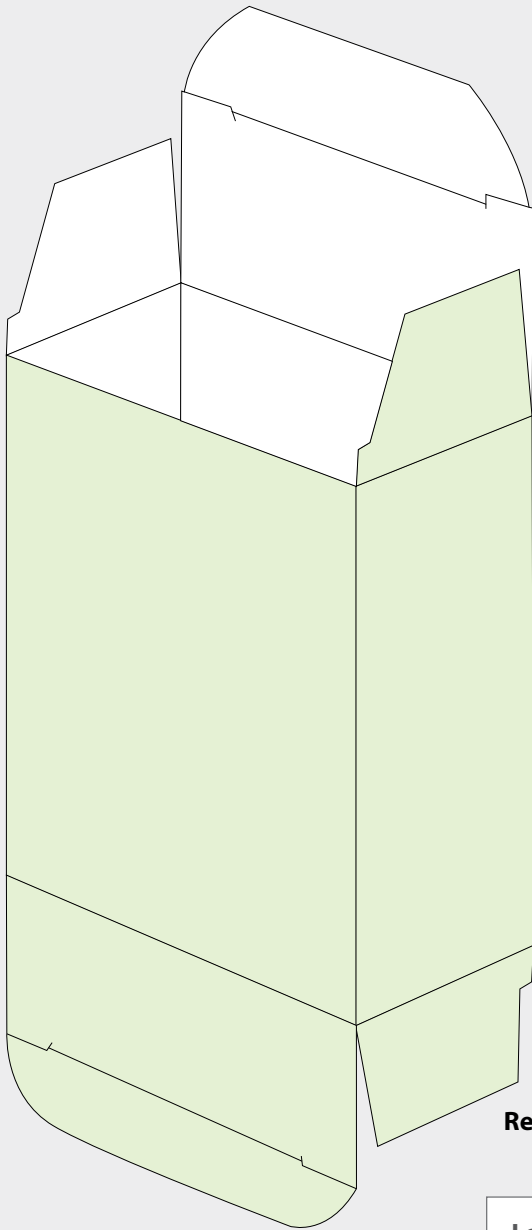

Straight Tuck End (STE)

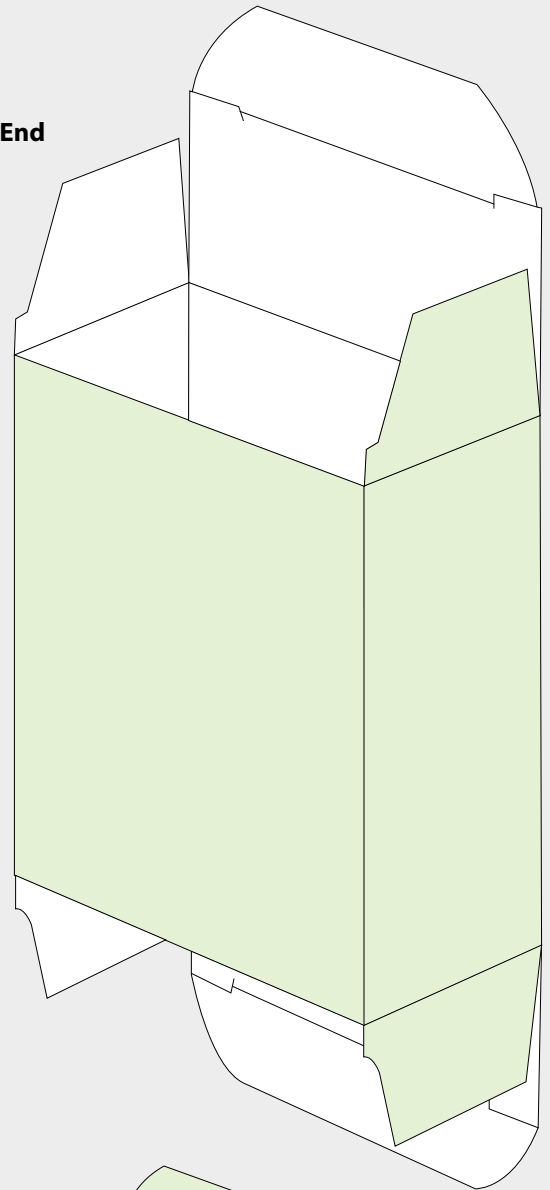

Reverse Tuck End (RTE)

Locate Item number from the size table, then look for the price below!

Tuck End

- Top or Bottom Loading
- Most Common Styles
- Easy Assembly
- STE is a More Appealing Look than RTE
- Friction Fit or Slit Lock Top
- Suitable for Lightweight Products
- Flat Shipping reduces the Total Cost

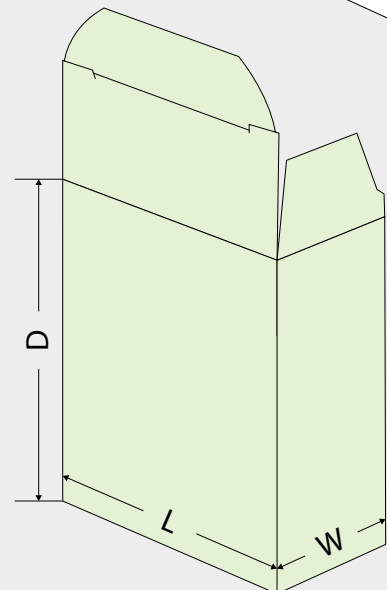

ITEM NO	W	L	D	ITEM NO	W	L	D	ITEM NO	W	L	D	ITEM NO	W	L	D			
U5520	1	1	1	U5523	2	2	1	U5524	3	2	3	U5523	4	2	1			
	1	1	2		2	2	2		4	4	2		2					
U5521	1	1	3		2	2	3		3	2	5		4	2	3			
	1	1	4		2	2	4		3	2	6		4	2	4			
	1	1	5		2	2	5		3	2	7		4	2	5			
U5522	1	1	6		2	2	6		3	2	8		4	2	6			
	1	1	7		U5524	2	2		7	3	2		9	4	3	1		
	1	1	8			2	2		8	3	2		10	4	3	2		
U5523	1	1	9		2	2	9		3	2	11		4	3	3			
	1	1	10		2	2	10		3	2	12		4	3	4			
	1	1	11		2	2	11		3	3	1		4	4	1			
	1	1	12		2	2	12		3	3	2		4	4	2			
	1	1	13		U5521	3	1		1	3	3		3	5	1	1		
	1	1	14			3	1		2	3	3		4	5	1	2		
U5521	2	1	1	U5523	3	1	3	U5522	4	1	1	U5524	5	1	3			
	2	1	2		3	1	4		4	1	2		5	1	4			
U5523	2	1	3		3	1	5		U5523	4	1		3	5	1	5		
	2	1	4		3	1	6			4	1		4	5	1	6		
	2	1	5		3	1	7			4	1		5	5	1	7		
	2	1	6		3	1	8			U5524	4		1	6	5	1	8	
	2	1	7		U5524	3	1				9		4	1	7	5	2	1
	2	1	8			3	1				10		4	1	8	5	2	2
U5524	2	1	9			3	1		11		4		1	9	5	2	3	
	2	1	10			3	1		12	4	1		10	5	2	4		
	2	1	11		3	1	13		4	1	11		5	2	5			
	2	1	12		3	1	14		4	1	12		5	2	6			
	2	1	13		U5523	3	2		1	4	1		13	5	3	1		
	2	1	14			3	2		2	4	1		14	5	3	2		

Any in between size is possible!

ITEM NO	W	L	D
	5	3	3
	5	3	4
U5523	6	1	1
	6	1	2
U5524	6	1	3
	6	1	4
	6	1	5
	6	1	6
	6	1	7
	6	1	8
	6	2	1
	6	2	2
	6	2	3
	6	2	4
	6	2	5
	6	2	6
U5523	7	1	1
	7	1	2
U5524	7	1	3
	7	1	4
	7	1	5
	7	1	6
	7	1	7
	7	1	8

Custom Folding Cartons : We offer high quality full custom folding cartons. Our minimum starts at 50 boxes.
 No die charge and Free Setup! You can order any in between size not stated in the size table. Price applies to the next larger size item that fits your size.
Need a Larger Size or Quantity not Listed? For larger sizes, quantities, or thicker stock, please contact factory for a quote!

DIGITAL		16C							
ITEM NO		50	100	150	200	250	300	350	400
U5520	One Side	6.18	3.89	3.13	2.75	2.52	2.37	2.26	2.18
U5521	One Side	6.79	4.51	3.75	3.37	3.14	2.99	2.88	2.80
U5522	One Side	7.41	5.13	4.37	3.99	3.77	3.62	3.51	3.43
U5523	One Side	8.66	6.38	5.62	5.24	5.01	4.86	4.75	4.67
U5524	One Side	10.39	8.11	7.35	6.97	6.75	6.60	6.13	5.55
ITEM NO		500	750	1000	1500	2500	5000	7500	10000
U5520	One Side	2.07	1.75	1.63	1.36	0.91	0.58	0.48	0.42
U5521	One Side	2.69	2.37	2.04	1.46	1.01	0.68	0.58	0.52
U5522	One Side	3.31	2.72	2.14	1.55	1.10	0.78	0.67	0.62
U5523	One Side	4.16	2.91	2.33	1.75	1.30	0.98	0.87	0.82
U5524	One Side	4.74	3.49	2.93	2.34	1.89	1.57	1.46	1.41

Specifications

- Full Color Shortrun Custom Printed Folding Cartons
- Free Setup / Art / Logos
 - Bleeds Allowed on All Sides
 - No Die Charge on Standard Sizes
 - No Overrun Charge
 - No Pre-fixed Sizes
 - Made in USA

Material

U5520~5524 : 11.4 pt Gloss Cover

Printing

Digital : Full Color Printing on One Side

Custom Size

Custom Size Available, add

Custom Shape : \$150.00 (G) each custom size

Option

Dieline Design : \$125.00 (G) each, sample extra

No Print Sample : \$40.00 (G) for 2 pcs / die

Artwork Change : \$67.00 (G) each

seal end FOLDING CARTONS

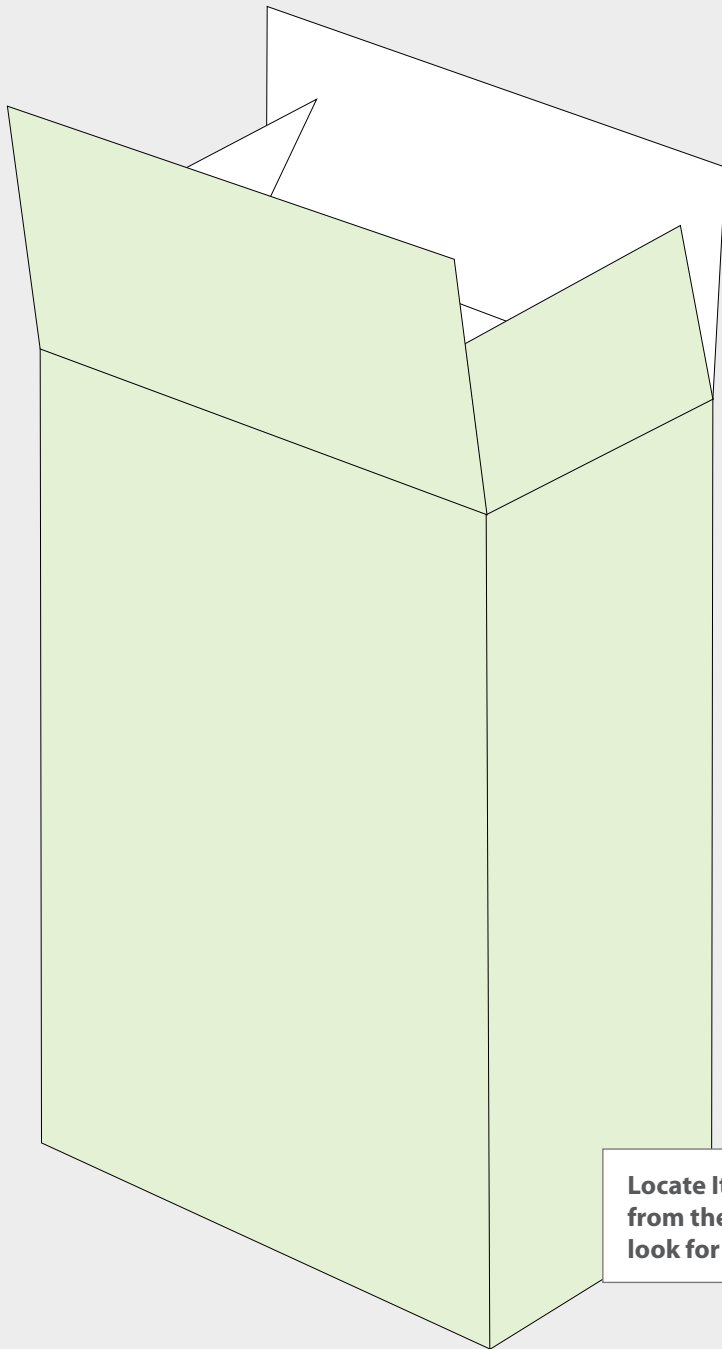

Shortrun Custom Folding Cartons

- Easy Top Loading
- Full Overlap Seal End
- Full panel top & bottom closure
- More Expensive Look
- Sits Flat on Retail Shelves
- Inserts can be added to hold Vials
- Suitable for Heavy Weight Products
- Flat Shipping reduces the Total Cost

Locate Item number from the size table, then look for the price below!

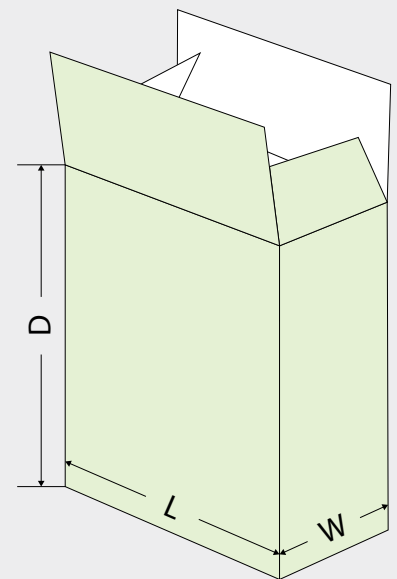

Custom Folding Cartons : We offer high quality full custom folding cartons. Our minimum starts at 50 boxes. Industry's lowest! No die charge and Free Setup! You can order any in between size not stated in the size table. Price applies to the next larger size item that fits your size.

Need a Larger Size or Quantity not Listed? For larger sizes, quantities, or thicker stock, please contact factory for a quote! We are capable of producing folding cartons up to 40 pt thick and larger sizes not listed here. Numerous finishes including embossing/debossing, aqueous coating, UV coating, and foil stamping can be added also.

ITEM NO	W	L	D	ITEM NO	W	L	D	ITEM NO	W	L	D	ITEM NO	W	L	D
U5530	1	1	1		2	2	8		3	3	2		4	4	4
	1	1	2	U5534	2	2	9		3	3	3	U5531	5	1	1
	1	1	3		2	2	10		3	3	4	U5532	5	1	2
	1	1	4		2	2	11		3	3	5	U5533	5	1	3
U5531	1	1	5		2	2	12		3	3	6		5	1	4
	1	1	6		2	2	13	U5530	4	1	1	U5534	5	1	5
	1	1	7		2	2	14	U5531	4	1	2		5	1	6
U5532	1	1	8	U5530	3	1	1	U5532	4	1	3		5	1	7
	1	1	9		3	1	2		4	1	4		5	1	8
	1	1	10	U5531	3	1	3	U5533	4	1	5		5	1	9
U5533	1	1	11		3	1	4		4	1	6		5	1	10
	1	1	12	U5533	3	1	5		4	1	7	U5533	5	2	1
	1	1	13		3	1	6	U5534	4	1	8		5	2	2
	1	1	14		3	1	7		4	1	9	U5534	5	2	3
	1	1	15		3	1	8		4	1	10		5	2	4
U5530	2	1	1		3	1	9		4	1	11		5	2	5
	2	1	2		3	1	10		4	1	12		5	2	6
U5531	2	1	3	U5534	3	1	11		4	1	13		5	2	7
	2	1	4		3	1	12		4	1	14		5	2	8
U5533	2	1	5		3	1	13		4	1	15		5	3	1
	2	1	6		3	1	14	U5533	4	2	1		5	3	2
	2	1	7		3	1	15		4	2	2		5	3	3
	2	1	8	U5532	3	2	1	U5534	4	2	3		5	3	4
	2	1	9		3	2	2		4	2	4		5	3	5
	2	1	10	U5533	3	2	3		4	2	5		5	3	6
U5534	2	1	11		3	2	4		4	2	6	U5531	6	1	1
	2	1	12		3	2	5		4	2	7	U5532	6	1	2
	2	1	13	U5534	3	2	6		4	2	8	U5533	6	1	3
	2	1	14		3	2	7		4	3	1				
	2	1	15		3	2	8		4	3	2				
U5531	2	2	1		3	2	9		4	3	3				
	2	2	2		3	2	10		4	3	4				
U5533	2	2	3		3	2	11		4	3	5				
	2	2	4		3	2	12		4	3	6				
	2	2	5		3	2	13		4	4	1				
	2	2	6		3	2	14		4	4	2				
	2	2	7		3	3	1		4	4	3				

Any in between size is possible!

ITEM NO	W	L	D
	6	1	4
U5534	6	1	5
	6	1	6
	6	1	7
	6	1	8
	6	1	9
	6	1	10
U5533	6	2	1
	6	2	2
U5534	6	2	3
	6	2	4
	6	2	5
	6	2	6
	6	2	7
	6	2	8
U5531	7	1	1
U5532	7	1	2
U5533	7	1	3
	7	1	4
U5534	7	1	5
	7	1	6
	7	1	7
	7	1	8
	7	1	9
	7	1	10

Specifications

Full Color Shortrun Custom Printed Folding Cartons

- Free Setup / Art / Logos
- Bleeds Allowed on All Sides
- No Die Charge on Standard Sizes
- No Overrun Charge
- No Pre-fixed Sizes
- Made in USA

Material

U5530~5534 : 11.4 pt Gloss Cover

Printing

Digital : Full Color Printing on One Side

Custom Size

Custom Size Available, add

Custom Shape : \$150.00 (G) each custom size

Option

Dieline Design : \$125.00 (G) each, sample extra

No Print Sample : \$40.00 (G) for 2 pcs / die

Artwork Change : \$67.00 (G) each



DIGITAL

16C

ITEM NO		50	100	150	200	250	300	350	400
U5530	One Side	6.59	4.31	3.55	3.17	2.94	2.79	2.68	2.60
U5531	One Side	7.21	4.93	4.17	3.79	3.56	3.41	3.30	3.22
U5532	One Side	7.83	5.55	4.79	4.41	4.18	4.03	3.92	3.84
U5533	One Side	8.93	6.66	5.90	5.52	5.29	5.14	5.03	4.95
U5534	One Side	10.65	8.38	7.62	7.24	7.01	6.86	6.13	5.55
ITEM NO		500	750	1000	1500	2500	5000	7500	10000
U5530	One Side	2.48	2.17	1.94	1.36	0.91	0.58	0.48	0.42
U5531	One Side	3.11	2.62	2.04	1.46	1.01	0.68	0.58	0.52
U5532	One Side	3.73	2.72	2.14	1.55	1.10	0.78	0.67	0.62
U5533	One Side	4.16	2.91	2.33	1.75	1.30	0.98	0.87	0.82
U5534	One Side	4.74	3.49	2.93	2.34	1.89	1.57	1.46	1.41

TUCK TOP SNAP LOCK BOTTOM

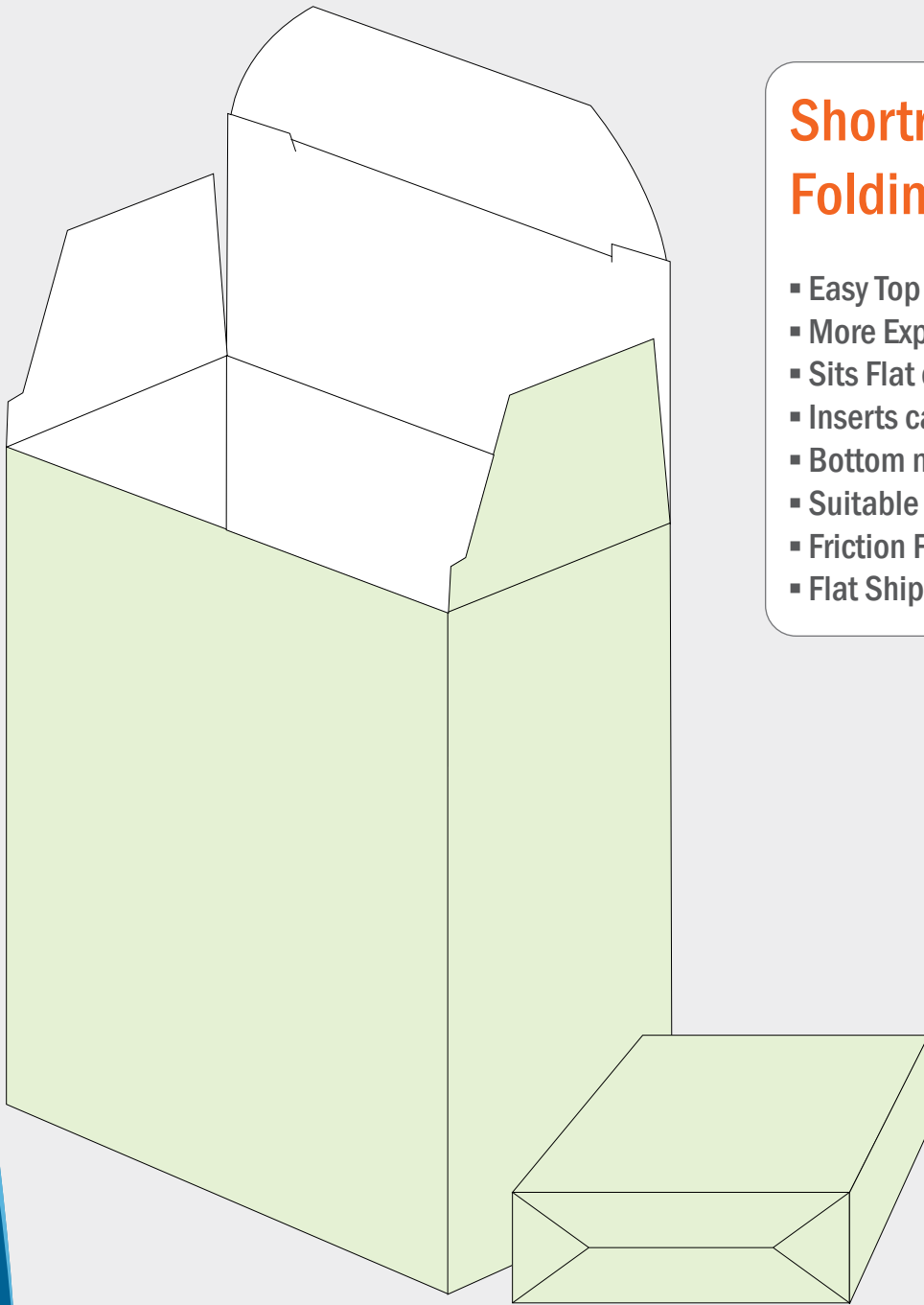

Shortrun Custom Folding Cartons

- Easy Top Loading
- More Expensive Look
- Sits Flat on Retail Shelves
- Inserts can be added to hold Vials
- Bottom needs Manual Assembly
- Suitable for Lightweight Products
- Friction Fit or Slit Locks Top
- Flat Shipping reduces the Total Cost

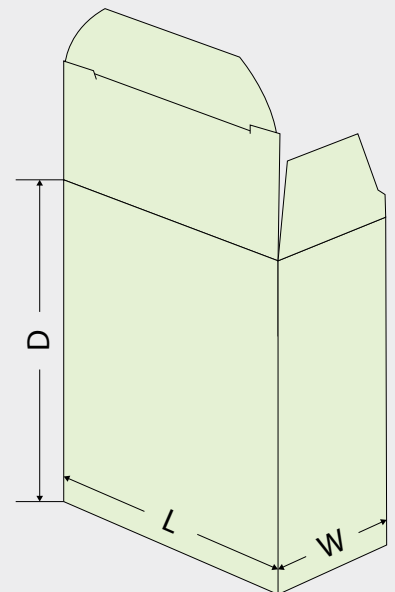

Custom Folding Cartons : We offer high quality full custom folding cartons. Our minimum starts at 50 boxes. Industry's lowest! No die charge and Free Setup! You can order any in between size not stated in the size table. Price applies to the next larger size item that fits your size.

Need a Larger Size or Quantity not Listed? For larger sizes, quantities, or thicker stock, please contact factory for a quote! We are capable of producing folding cartons up to 40 pt thick and larger sizes not listed here. Numerous finishes including embossing/debossing, aqueous coating, UV coating, and foil stamping can be added also.

ITEM NO	W	L	D	ITEM NO	W	L	D	ITEM NO	W	L	D	ITEM NO	W	L	D	Any in between size is possible!			
U5540	1	1	1		2	2	5		3	2	11		4	3	4	ITEM NO	5	3	6
	1	1	2		2	2	6		3	2	12		4	3	5		6	1	1
	1	1	3		2	2	7		3	2	13		4	3	6		6	1	2
U5541	1	1	4	U5544	2	2	8		3	3	1		4	4	1	U5542	6	1	1
	1	1	5		2	2	9		3	3	2		4	4	2		6	1	2
	1	1	6		2	2	10		3	3	3		4	4	3		6	1	3
U5542	1	1	7		2	2	11		3	3	4	U5542	5	1	1	U5544	6	1	4
	1	1	8		2	2	12		3	3	5		5	1	2		6	1	5
	1	1	9		2	2	13		3	3	6		5	1	3		6	1	6
U5543	1	1	10	U5540	3	1	1	U5541	4	1	1	U5544	5	1	4	U5543	6	1	7
	1	1	11	U5541	3	1	2	U5542	4	1	2		5	1	5		6	1	8
	1	1	12	U5543	3	1	3	U5543	4	1	3		5	1	6		6	1	9
	1	1	13		3	1	4		4	1	4		5	1	7		6	2	1
	1	1	14		3	1	5		4	1	5		5	1	8		6	2	2
	1	1	15		3	1	6		4	1	6		5	1	9		6	2	3
U5540	2	1	1	3	1	7	U5544	4	1	7	U5543	5	2	1	U5544	6	2	4	
U5541	2	1	2	3	1	8	4	1	8	5		2	2	6		2	5		
2	1	3	3	1	9	4	1	9	5	2		3	6	2		6			
U5543	2	1	4	U5544	3	1	10		4	1	10		5	2	3	U5542	7	1	1
	2	1	5		3	1	11		4	1	11		5	2	4		7	1	2
	2	1	6		3	1	12		4	1	12		5	2	5		7	1	3
	2	1	7		3	1	13		4	1	13		5	2	6		7	1	4
	2	1	8		3	1	14		4	1	14		5	2	7		7	1	5
	2	1	9		3	1	15		4	1	15		5	3	1		7	1	6
U5544	2	1	10	U5542	3	2	1	U5543	4	2	1	U5544	5	3	2	U5543	7	1	7
	2	1	11	U5543	3	2	2	U5544	4	2	2		5	3	3		7	1	8
	2	1	12	3	2	3	4	2	3	5	3		4	7	1		9		
	2	1	13	3	2	4	4	2	4	5	3		5	7	1		9		
	2	1	14	U5544	3	2	5	4	2	5	U5544		4	2	5		U5544	7	1
2	1	15	3		2	6	4	2	6	4		2	7	7	1	5			
U5541	2	2	1	3	2	7	4	2	7	4	3	1	7	1	6				
U5543	2	2	2	3	2	8	4	3	1	4	3	2	7	1	7				
	2	2	3	3	2	9	4	3	2	4	3	3	7	1	8				
	2	2	4	3	2	10	4	3	3	4	3	4	7	1	9				

Locate Item number from the above size table, then look for the price below!

DIGITAL		16C							
ITEM NO		50	100	150	200	250	300	350	400
U5540	One Side	6.34	4.05	3.29	2.91	2.68	2.53	2.42	2.34
U5541	One Side	6.96	4.67	3.91	3.53	3.30	3.15	3.04	2.96
U5542	One Side	7.57	5.29	4.53	4.15	3.93	3.77	3.67	3.59
U5543	One Side	8.82	6.54	5.78	5.40	5.17	5.02	4.91	4.83
U5544	One Side	10.56	8.28	7.52	7.14	6.92	6.77	6.13	5.55
ITEM NO		500	750	1000	1500	2500	5000	7500	10000
U5540	One Side	2.23	1.91	1.79	1.36	0.91	0.58	0.48	0.42
U5541	One Side	2.85	2.53	2.04	1.46	1.01	0.68	0.58	0.52
U5542	One Side	3.47	2.72	2.14	1.55	1.10	0.78	0.67	0.62
U5543	One Side	4.16	2.91	2.33	1.75	1.30	0.98	0.87	0.82
U5544	One Side	4.74	3.49	2.93	2.34	1.89	1.57	1.46	1.41

Specifications

Full Color Shortrun Custom Printed Folding Cartons

- Free Setup / Art / Logos
- Bleeds Allowed on All Sides
- No Die Charge on Standard Sizes
- No Overrun Charge
- No Pre-fixed Sizes
- Made in USA

Material
U5540~5544 : 11.4 pt Gloss Cover

Printing
Digital : Full Color Printing on One Side

Custom Size
Custom Size Available, add
Custom Shape : \$150.00 (G) each custom size

Option
DieLine Design : \$125.00 (G) each, sample extra
No Print Sample : \$40.00 (G) for 2 pcs / die
Artwork Change : \$67.00 (G) each

FAVOR BOXES

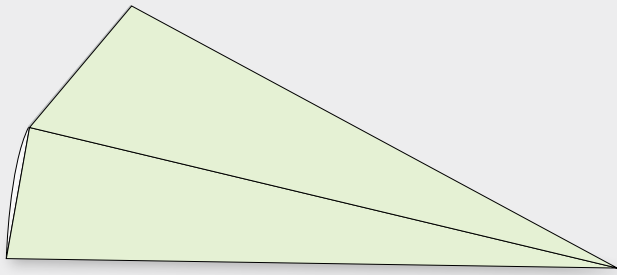

U5570
2" x 2" x 5" length

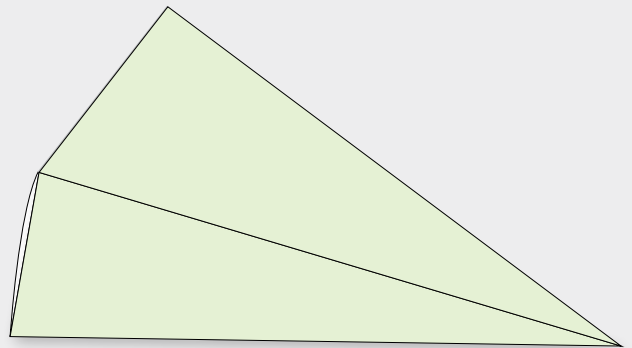

U5571
2 1/2" x 2 1/2" x 5" length

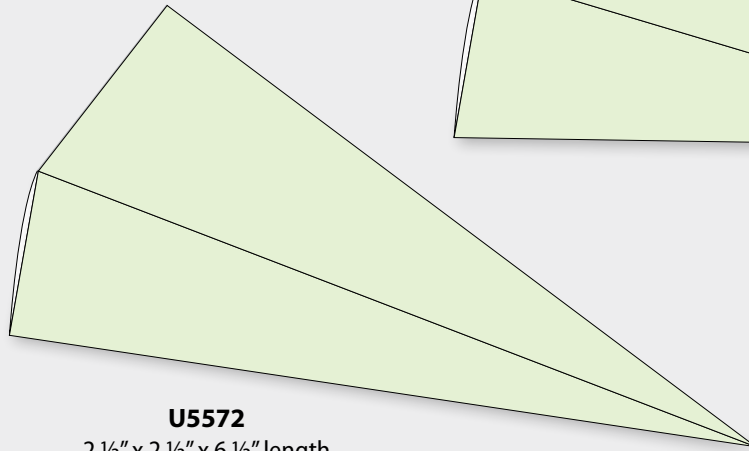

U5572
2 1/2" x 2 1/2" x 6 1/2" length

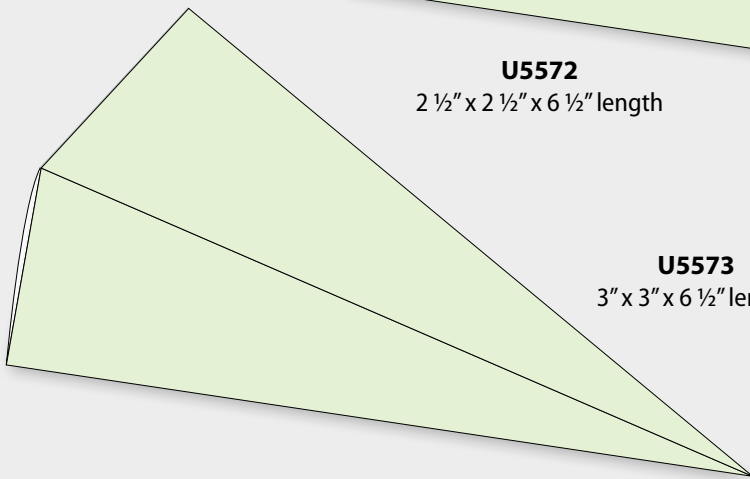

U5573
3" x 3" x 6 1/2" length

Custom Size : You can order any in between size not stated in the size table. Price applies to the next larger size item that fits your size.

Need a Larger Size or Quantity not Listed? For larger sizes or quantities or thicker stock, please contact factory for a quote!

Specifications

Full Color Party Favor Boxes on Coated Stock.

- Free Setup / Art / Logos
- Bleeds Allowed on All Sides
- No Die Charge on Standard Sizes
- No Ovrerrun Charge
- Available in One Thickness
- Available in Four Standard Sizes
- Made in USA

Material

U5570~5573 : 11.4 pt Gloss Cover

Printing

Digital : Full Color Printing on One Side

Custom Size

Custom Size Available, add

Custom Shape : \$150.00 (G) each custom size

Option

Dieline Design : \$125.00 (G) each, sample extra

No Print Sample : \$40.00 (G) for 2 pcs / die

Artwork Change : \$67.00 (G) each



DIGITAL

16C

ITEM NO		50	100	150	200	250	300	350	400
U5570	One Side	7.16	4.71	3.89	3.49	3.24	3.08	2.96	2.88
U5571	One Side	7.50	5.06	4.24	3.83	3.59	3.43	3.31	3.22
U5572	One Side	8.11	5.66	4.85	4.44	4.20	4.03	3.92	3.83
U5573	One Side	8.26	5.82	5.00	4.60	4.35	4.19	4.07	3.99
ITEM NO		500	750	1000	1500	2500	5000	7500	10000
U5570	One Side	2.75	2.42	2.06	1.47	1.01	0.69	0.58	0.52
U5571	One Side	3.10	2.74	2.15	1.56	1.11	0.78	0.68	0.62
U5572	One Side	3.71	2.93	2.35	1.76	1.31	0.98	0.87	0.82
U5573	One Side	3.86	2.93	2.35	1.76	1.31	0.98	0.87	0.82

PILLOW BOXES

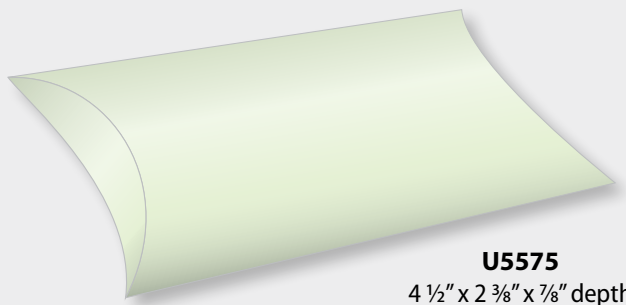

U5575
4 1/2" x 2 3/8" x 7/8" depth

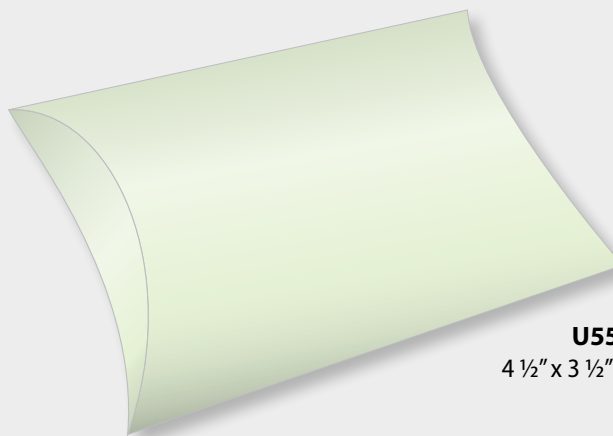

U5576
4 1/2" x 3 1/2" x 1" depth

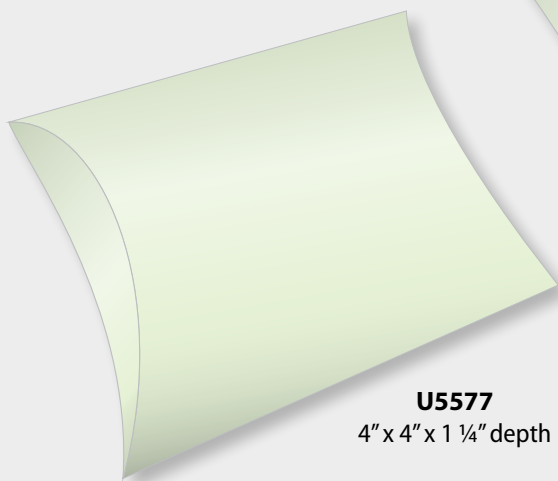

U5577
4" x 4" x 1 1/4" depth

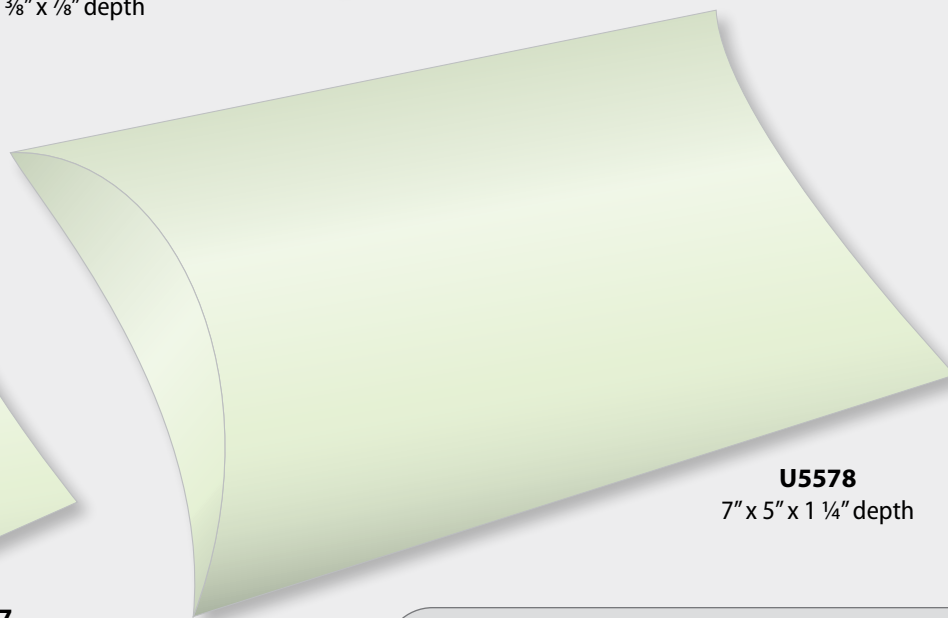

U5578
7" x 5" x 1 1/4" depth

Custom Size : You can order any in between size not stated in the size table. Price applies to the next larger size item that fits your size.
Need a Larger Size or Quantity not Listed? For larger sizes or quantities or thicker stock, please contact factory for a quote!

		DIGITAL								16C
ITEM NO		50	100	150	200	250	300	350	400	
U5575	One Side	6.90	4.28	3.41	2.97	2.71	2.54	2.41	2.32	
U5576	One Side	7.30	4.69	3.82	3.38	3.12	2.95	2.82	2.73	
U5577	One Side	7.36	4.75	3.88	3.44	3.18	3.01	2.88	2.79	
U5578	One Side	8.42	5.81	4.94	4.51	4.24	4.07	3.95	3.85	
ITEM NO		500	750	1000	1500	2500	5000	7500	10000	
U5575	One Side	2.19	1.85	1.72	1.38	0.92	0.59	0.48	0.43	
U5576	One Side	2.60	2.26	2.07	1.48	1.02	0.69	0.58	0.53	
U5577	One Side	2.66	2.32	2.07	1.48	1.02	0.69	0.58	0.53	
U5578	One Side	3.72	2.96	2.36	1.77	1.32	0.98	0.88	0.82	

Specifications

- Full Color Pillow Boxes on Coated Cover.
- Free Setup / Art / Logos
 - Bleeds Allowed on All Sides
 - No Die Charge on Standard Sizes
 - No Overrun Charge
 - Available in One Thickness
 - Available in Four Standard Sizes
 - Made in USA

Material

U5575~5578 : 11.4 pt Gloss Cover

Printing

Digital : Full Color Printing on One Side

Custom Size

Custom Size Available, add

Custom Shape : \$150.00 (G) each custom size

Option

Dieline Design : \$125.00 (G) each, sample extra

No Print Sample : \$40.00 (G) for 2 pcs / die

Artwork Change : \$67.00 (G) each

dry erase UNIQ PRINT™



You can order any size not stated in the available sizes.
Price applies to the next larger size item that fits your size.



5C

ITEM NO		5	10	25	50	100
U6220	8" x 10"	49.47	39.47	33.47	31.47	30.47
U6221	8" x 12"	51.31	41.31	35.31	33.31	32.31
U6222	12" x 12"	74.44	64.44	58.44	56.44	55.44
U6223	11" x 14"	77.30	67.30	61.30	59.30	58.30
U6224	12" x 18"	81.51	71.51	65.51	63.51	62.51
U6225	16" x 16"	89.12	79.12	73.12	71.12	70.12
U6226	12" x 24"	91.91	81.91	75.91	73.91	72.91
U6227	16" x 20"	94.09	84.09	78.09	76.09	75.09
U6228	16" x 24"	101.84	91.84	85.84	83.84	82.84
U6229	20" x 20"	102.93	92.93	86.93	84.93	83.93
U6230	20" x 24"	110.98	100.98	94.98	92.98	91.98
U6231	24" x 24"	155.92	145.92	139.92	137.92	136.92
U6232	20" x 30"	154.08	144.08	138.08	136.08	135.08
U6233	24" x 30"	166.65	156.65	150.65	148.65	147.65
U6234	24" x 36"	177.39	167.39	161.39	159.39	158.39
U6235	30" x 40"	201.86	191.86	185.86	183.86	182.86

Specifications

Full Color Graphics Printed Directly on Dry Erase Board. A very smooth, clean dry erase writing surface that won't ghost and erases great every time.

You can create the most colorful custom boards with us.

- Free Setup / Art / Logos
- Bleeds Allowed on All Sides
- Ready to Hang
- Made in USA

Material

U6220~U6235 : 3 mm Dry Erase Board

Printing

Inkjet : Full Color Printing on One Side

Custom Shape

No Charge for Round Corners / Circle

Custom Shape Available, add

Setup Charge : \$40.00 (G) each shape plus

Running Cost : \$0.05 (G) per linear cutting inch

Packaging

Kraft Corrugated Individual Box

UNIQU PRINT™ chalk board



You can order any size not stated in the available sizes.
Price applies to the next larger size item that fits your size.

ITEM NO		5	10	25	50	100
U6240	8" x 10"	56.59	46.59	40.59	38.59	37.59
U6241	8" x 12"	59.82	49.82	43.82	41.82	40.82
U6242	12" x 12"	88.38	78.38	72.38	70.38	69.38
U6243	11" x 14"	92.62	82.62	76.62	74.62	73.62
U6244	12" x 18"	100.90	90.90	84.90	82.90	81.90
U6245	16" x 16"	115.50	105.50	99.50	97.50	96.50
U6246	12" x 24"	120.17	110.17	104.17	102.17	101.17
U6247	16" x 20"	124.16	114.16	108.16	106.16	105.16
U6248	16" x 24"	138.44	128.44	122.44	120.44	119.44
U6249	20" x 20"	140.44	130.44	124.44	122.44	121.44
U6250	20" x 24"	155.12	145.12	139.12	137.12	136.12
U6251	24" x 24"	227.29	217.29	211.29	209.29	208.29
U6252	20" x 30"	215.55	205.55	199.55	197.55	196.55
U6253	24" x 30"	246.27	236.27	230.27	228.27	227.27
U6254	24" x 36"	265.26	255.26	249.26	247.26	246.26
U6255	30" x 40"	308.94	298.94	292.94	290.94	289.94

Specifications

Full Color Graphics Printed Directly on Black Chalkboard. Chalkboard signs and menus are a unique and colorful way to add originality and an artistic flare to your cafe, restaurant, coffee shop or any retail business.

- Free Setup / Art / Logos
- Bleeds Allowed on All Sides
- Ready to Hang
- Made in USA

Material

U6240~U6255 : 3 mm Black Chalk Board

Printing

Inkjet : Full Color + White Printing on One Side

Custom Shape

No Charge for Round Corners / Circle

Custom Shape Available, add

Setup Charge : \$40.00 (G) each shape plus

Running Cost : \$0.05 (G) per linear cutting inch

Packaging

Kraft Corrugated Individual Box

faux canvas IMAGE WRAP™



Contemporary Gallery Wrap!

You can order any size not stated in the available sizes.
Price applies to the next larger size item that fits your size.
1 1/2" frame thickness is standard. 1" and 3/4" available at no cost



Front



Back

Specifications

Full Color Graphics Printed Directly on Faux-canvas Foamboard. Its embossed, textured surface adds depth to print. Transform your favorite digital photos as a beautiful piece of unique wall art. The Image continues over the sides of the frame.

- Free Setup / Art / Logos
- Ready to Hang Gallery Wrap
- Indoor Application Only
- Made in USA

Material

U7000~U7015 : 3/16" Faux-canvas Foamboard

Printing

Inkjet : Full Color Printing on One Side

Mirrored Edge

The Image Stops at the Edge
Wrapped Edges are a Reflection of the Main Image

Setup Charge : \$10 (G) each image

Packaging

White Corrugated Individual Box



INKJET

5C

ITEM NO		5	10	25	50	100
U7000	8" x 10"	66.19	57.86	52.86	51.19	50.36
U7001	8" x 12"	69.40	61.07	56.07	54.40	53.57
U7002	12" x 12"	95.15	86.82	81.82	80.15	79.32
U7003	11" x 14"	96.66	88.33	83.33	81.66	80.83
U7004	12" x 18"	106.69	98.35	93.35	91.69	90.85
U7005	16" x 16"	111.07	102.73	97.73	96.07	95.23
U7006	12" x 24"	119.34	111.01	106.01	104.34	103.51
U7007	16" x 20"	121.52	113.18	108.18	106.52	105.68
U7008	16" x 24"	129.18	120.85	115.85	114.18	113.35
U7009	20" x 20"	135.87	127.54	122.54	120.87	120.04
U7010	20" x 24"	150.21	141.88	136.88	135.21	134.38
U7011	24" x 24"	176.72	168.39	163.39	161.72	160.89
U7012	20" x 30"	180.01	171.68	166.68	165.01	164.18
U7013	24" x 30"	191.49	183.16	178.16	176.49	175.66
U7014	24" x 36"	206.25	197.92	192.92	191.25	190.42
U7015	30" x 40"	248.59	240.26	235.26	233.59	232.76

POPOUT™



Specifications

Eye catching Popout™ with customer supplied objects with custom printed background.

- Free Art / Logos
- Bleeds Allowed on All Sides
- Consult with factory regarding centerpiece's size and weight limitation
- Made in USA

Material

U7260 : 1 mm Clear Plastic (popout)
+ 3 mm EPVC (back panel) + Black Aluminum Frame

Printing

Digital : Full Color Printing on One Side of Base (EPVC)

Setup Charge

\$55 (G) per artwork or object : initial order only

Frame

3/16" Black Aluminum Frame Included

Packaging

Kraft Corrugated Box



5C

ITEM NO	5	10	25	50	100	
U7260	14" x 21"	219.31	204.31	195.31	192.31	190.81

ACOUSTIC CEILING TILES



Specifications

Full Color Graphics Printed Directly on Acoustic Ceiling Tiles. Custom tiles are a unique way to turn white ceiling into something colorful, creative and fun. And the results are jaw droppingly awesome! Perfect for medical offices, salons, spas, and/or advertising other services.

- Free Setup / Art / Logos
- Bleeds Allowed on All Sides
- Made in USA

Material

U7200~U7201 : 2' x 2' or 2' x 4' Acoustic Ceiling Tile

Printing

Inkjet : Full Color Printing on One Side

Custom Shape

No Custom Shape

Option

Artwork Change : \$67.00 (G) each

Packaging

Kraft Corrugated Bulk Box



5C

ITEM NO		5	10	25	50	100
U7200	2' x 2'	65.03	56.70	53.70	52.03	51.20
U7201	2' x 4'	108.40	100.07	97.07	95.40	94.57

CUBE awards



Aluminum

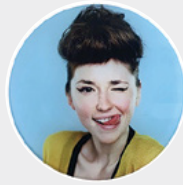

Clear Plastic

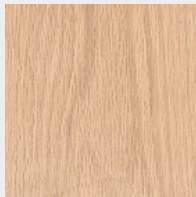

U8120 / 8130
Red Oak

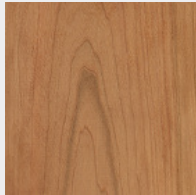

U8122 / 8132
Cherry

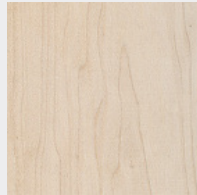

U8123 / 8133
Hard Maple



U8130
3" x 3" x 3"
Aluminum on Red Oak



U8120
3" x 3" x 3"
Clear Plastic on Red Oak

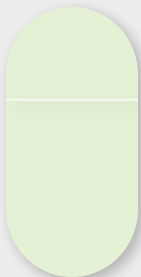

Shape 01

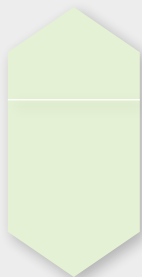

Shape 02

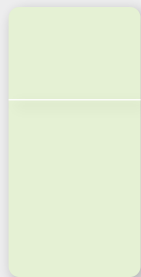

Shape 03

Specifications

Wood Cube Award with Printed Plate is a cost-effective and environmentally friendly option.

- Free Setup / Art / Logos / Personalization
- Bleeds Allowed on All Sides
- Hand-rubbed Finish
- Available in Three Plate Decoration Materials
- Made in USA

Material

U8120/8122/8123 : Solid Wood Block + 1 mm Clear Plastic

U8130/8132/8133 : Solid Wood Block + 20mil Aluminum

Printing

Inkjet : Full Color + White Printing on One Side of Plate

Print Area : 2 3/4" x 5 5/8"

Packaging

Individual White Corrugated Box

Option

Custom Plate Shape : \$25.00 (G) each



6C

ITEM NO			5	10	25	50	100	250
U8120	Plastic	Red Oak	63.28	56.61	52.61	51.28	50.61	50.21
U8122	Plastic	Cherry	64.43	57.76	53.76	52.43	51.76	51.36
U8123	Plastic	Hard Maple	64.31	57.65	53.65	52.31	51.65	51.25
U8130	Aluminum	Red Oak	64.31	59.31	56.31	55.31	54.81	54.51
U8132	Aluminum	Cherry	65.46	60.46	57.46	56.46	55.96	55.66
U8133	Aluminum	Hard Maple	65.34	60.34	57.34	56.34	55.84	55.54



awards TOWER



U8230
3" x 3" x 9"
Aluminum on Red Oak



U8200
2 1/2" x 2 1/2" x 7 1/4"
Clear Plastic on Red Oak

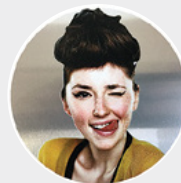

Aluminum

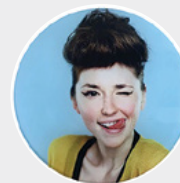

Clear Plastic

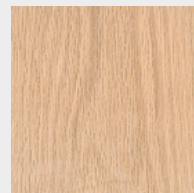

U8200 / 8210 / 8220 / 8230
Red Oak

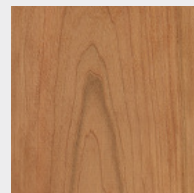

U8222 / 8232
Cherry

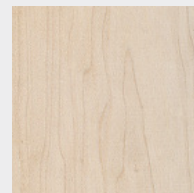

U8223 / 8233
Hard Maple

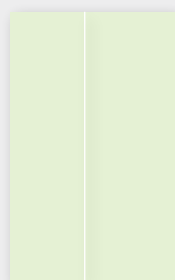

Shape 01

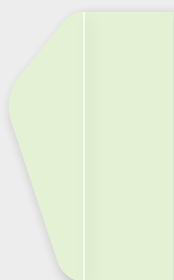

Shape 02

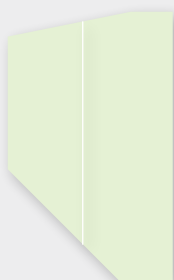

Shape 03

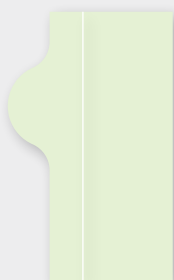

Shape 04

Specifications

Wooden Tower Award with Printed Plate is an economical and environmentally friendly option.

- Free Setup / Art / Logos / Personalization
- Bleeds Allowed on All Sides
- Hand-rubbed Finish
- Available in Two Plate Decoration Material
- Available in Four Standard Shapes
- Made in USA

Material

U8200 / 8220~8223 : Solid Wood Block + 1 mm Clear
U8210 / 8230~8233 : Solid Wood + 20mil Aluminum

Printing

Inkjet : Full Color + White Printing on One Side of Plate
Print Area U8200/8210 : 4 1/2" x 7 1/2"
Print Area U8220~8233 : 5 1/2" x 9"

Packaging

Individual White Corrugated Box

Option

Custom Plate Shape : \$25.00 (G) each



6C

ITEM NO			5	10	25	50	100	250
size : 2 1/2" x 2 1/2" x 7 1/4"								
U8200	Plastic	Red Oak	73.35	66.69	62.69	61.35	60.69	60.29
U8210	Aluminum	Red Oak	78.14	73.14	70.14	69.14	68.64	68.34
size : 3" x 3" x 9"								
U8220	Plastic	Red Oak	81.18	74.52	70.52	69.18	68.52	68.12
U8222	Plastic	Cherry	84.63	77.97	73.97	72.63	71.97	71.57
U8223	Plastic	Hard Maple	84.29	77.62	73.62	72.29	71.62	71.22
U8230	Aluminum	Red Oak	87.27	82.27	79.27	78.27	77.77	77.47
U8232	Aluminum	Cherry	90.72	85.72	82.72	81.72	81.22	80.92
U8233	Aluminum	Hard Maple	90.38	85.38	82.38	81.38	80.88	80.58

POPOUT™ awards



U8400
3 1/2" x 9 1/2" x 1 1/2"
Red Oak

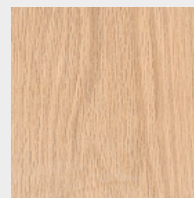

U8400
Red Oak

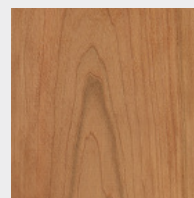

U8402
Cherry

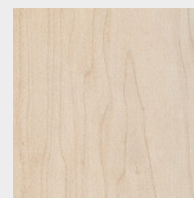

U8403
Hard Maple



Center Popout

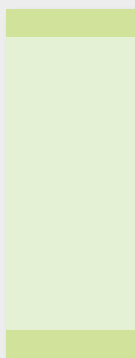

Base

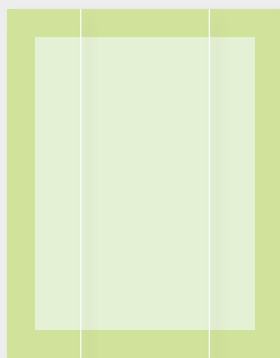

Encasement

Specifications

Solid Real Wood Cuboid™ combined with Eye Catching Popout™.

- Free Setup / Art / Logos / Personalization
- Bleeds Allowed on All Sides
- Hand-rubbed Finish
- Made in USA

Material

U8400~8403 : 1 mm Clear Plastic (Base & Encasement) + Solid Wood Block + 3 mm EPVC (Center Popout)

Printing

Inkjet : Full Color + White Printing on One Side

Print Area : 7 1/2" x 9 1/2" (Clear Encasement)

3 1/2" x 9 1/2" (Clear Base) 2" x 2" (Center Popout)

Packaging

Individual White Corrugated Box

Option

Artwork Change : \$27.00 (G) each



6C

ITEM NO		5	10	25	50	100	250
U8400	Red Oak	143.95	130.61	122.61	119.95	118.61	117.81
U8402	Cherry	148.47	135.13	127.13	124.47	123.13	122.33
U8403	Hard Maple	149.05	135.71	127.71	125.05	123.71	122.91



awards GLOW CUBOID™

U8350

3" x 10" x 1 1/4"

Clear Plastic on Red Oak

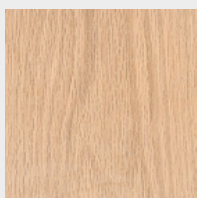

Red Oak



Orange Acrylic
Standard Color



Green Acrylic

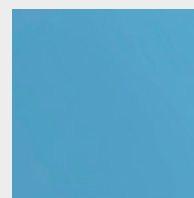

Blue Acrylic



Red Acrylic



Yellow Acrylic

Specifications

Direct Printed Sleek Solid Wood Cuboid™ award block with an opaque, resin top-piece. Fluorescent acrylic is attached at a slant to create the illusion of a colorful glow throughout the milky top-piece. Acrylic is available in multiple colors.

Each award is produced individually by hand.

- Free Setup / Art / Logos / Personalization
- Hand-rubbed Finish
- Orange Fluorescent Acrylic Standard
- Made in USA

Material

U8350 : Solid Wood Block + Fluorescent Acrylic + Resin

Printing

Inkjet : Full Color + White Printing on One Side

Print Area : 3" x 6 1/2"

Packaging

Individual White Corrugated Box

Option

Acrylic Color Change : \$30.00 (G) per order

Artwork Change : \$27.00 (G) each



6C

ITEM NO		5	10	25	50	100	250
U8350	Red Oak	106.26	102.92	100.92	100.26	99.92	99.72

GLOW TOWER™ awards



Front



Back

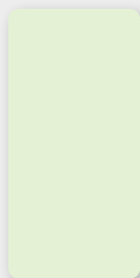

Shape 01

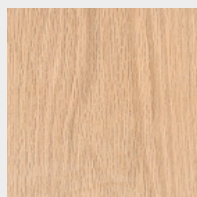

Red Oak

U8330

2 ½" x 10" x 2 ½"

Clear Plastic on Red Oak



Green Acrylic
Standard Color

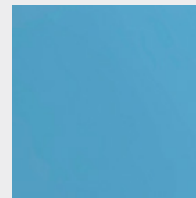

Blue Acrylic



Orange Acrylic



Red Acrylic



Yellow Acrylic

Specifications

Solid Wood Glow Tower™ award block with an opaque, resin top-piece. Fluorescent acrylic is attached at a slant to create the illusion of a colorful glow throughout the milky top-piece. Acrylic is available in multiple colors. Each award is produced individually by hand.

- Free Setup / Art / Logos / Personalization
- Hand-rubbed Finish
- Green Fluorescent Acrylic Standard
- Made in USA

Material

U8330 : Solid Wood Block + Fluorescent Acrylic + Resin

Printing

Inkjet : Full Color + White Printing on One Side of Plate

Print Area : 2" x 6"

Packaging

Individual White Corrugated Box

Option

Acrylic Color Change : \$30.00 (G) per order

Artwork Change : \$27.00 (G) each



6C

ITEM NO		5	10	25	50	100	250
U8330	Red Oak	117.03	110.36	106.36	105.03	104.36	103.96



awards CUBOID™

Cuboid™ Print
U8430-8433

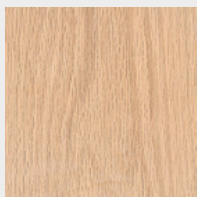

U8430
Red Oak

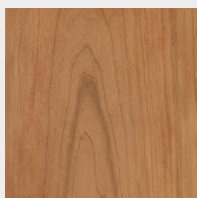

U8432
Cherry

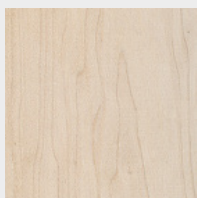

U8433
Hard Maple



U8432
3 1/2" x 9 1/2" x 1 1/2"
Cherry



Specifications

Direct Printed Sleek Solid Wood Cuboid™ award is an economical and environmentally friendly option.

- Free Setup / Art / Logos / Personalization
- Bleeds Allowed on All Sides
- Hand-rubbed Finish
- Made in USA

Material

U8430~8433 : Solid Wood Block

Printing

Inkjet : Full Color + White Printing on One Side

Print Area : 3 1/2" x 9 1/2"

Packaging

Individual White Corrugated Box

Option

White Underlay Image : \$5.00 (G) each

Artwork Change : \$27.00 (G) each



6C

ITEM NO		5	10	25	50	100	250
U8430	Red Oak	71.67	68.34	66.34	65.67	65.34	65.14
U8432	Cherry	76.19	72.86	70.86	70.19	69.86	69.66
U8433	Hard Maple	76.77	73.44	71.44	70.77	70.44	70.24

GENERAL TERMS

ALL prices are quoted in U.S. funds, F.O.B. factory. We reserve the right to change price, stock, size and format of items/products without notice. All sizes in this catalog have been rounded to the nearest 1/8 of an inch.

ORDERING INFORMATION

ORDER WRITING: Order information must include; purchase order number, quantity, item number, ad copy, ship date & method, options desired and imprint ink color. Ad copy should be typewritten or printed. We are not responsible for any mis-interpretation or mistake of a handwritten order or copy.

WRITTEN ACKNOWLEDGEMENT: An acknowledgement will be sent, either by fax or email, to verify that the order is proceeding. If you don't receive the acknowledgement within two weeks, please contact our office to insure that your order is not lost in the mail or in a fax transmission error.

CANCELLATIONS: If an order has been printed, it cannot be cancelled. If an order is cancelled after work has been approved. **\$50.00(G)**

CATALOG ILLUSTRATIONS: Logos and other imprints shown in this catalog are for illustrative purpose only. They do not imply endorsement, nor are any items with these specific logos for sale to anyone other than parties expressly authorized by the owner of such designs.

SHIPPING

SHIPPING DATES: Unless an order specifically states not to ship before a certain date, we reserve the right to ship as early as our production permits. Usual production time is two weeks.

PACKAGING: Bulk except where noted.

SHIPPING & HANDLING: Charges will be pre-paid, itemized and added to the invoice at published rates, plus a handling charge of **\$5.00** per box.

C.O.D. SHIPMENT: each C.O.D., add **\$40.00(G)**

DROP SHIPMENT:

- CONTINENTAL US: each Drop, add **\$20.00(G)**
- INT'L, AK & HI: each Drop, add **\$40.00(G)**

MAIL SERVICE: each mail piece (Postage Extra) **\$0.50(G)**

ELECTRONIC ARTWORK

Artworks prepared in the most popular graphic applications are acceptable and can be sent either in a disk or through email. Preferred file formats include Adobe InDesign®, Adobe Illustrator®, Adobe Photoshop®, and EPS, PDF, or Tiff in either MAC or PC format. Send artwork to artwork@unicorngraphics.com.

IMPRINTING

AD COPY & LOGOS: We encourage that the ad copy be generated in a graphic application. No additional charge for straight typesetting applies unless you request exact type match. Any additional artwork charge depends on the amount of work involved. You will be notified in advance for the extra charge.

• Minimum artwork charge starts at **\$50.00(G)**

PANTONE COLOR: If a Pantone number is specified in the order, it will be converted into four color process. NO PMS COLOR.

AD COPY PROOFS:

- PDF email proof..... **\$0.00(G)**
- Fax or Mail proof..... **\$20.00(G)**
- Digital Color proof..... **\$20.00(G)**



BLEEDS AREA : 1/8" ON ALL FOUR SIDES

LIVE AREA 1/8" INSIDE TRIM LINE

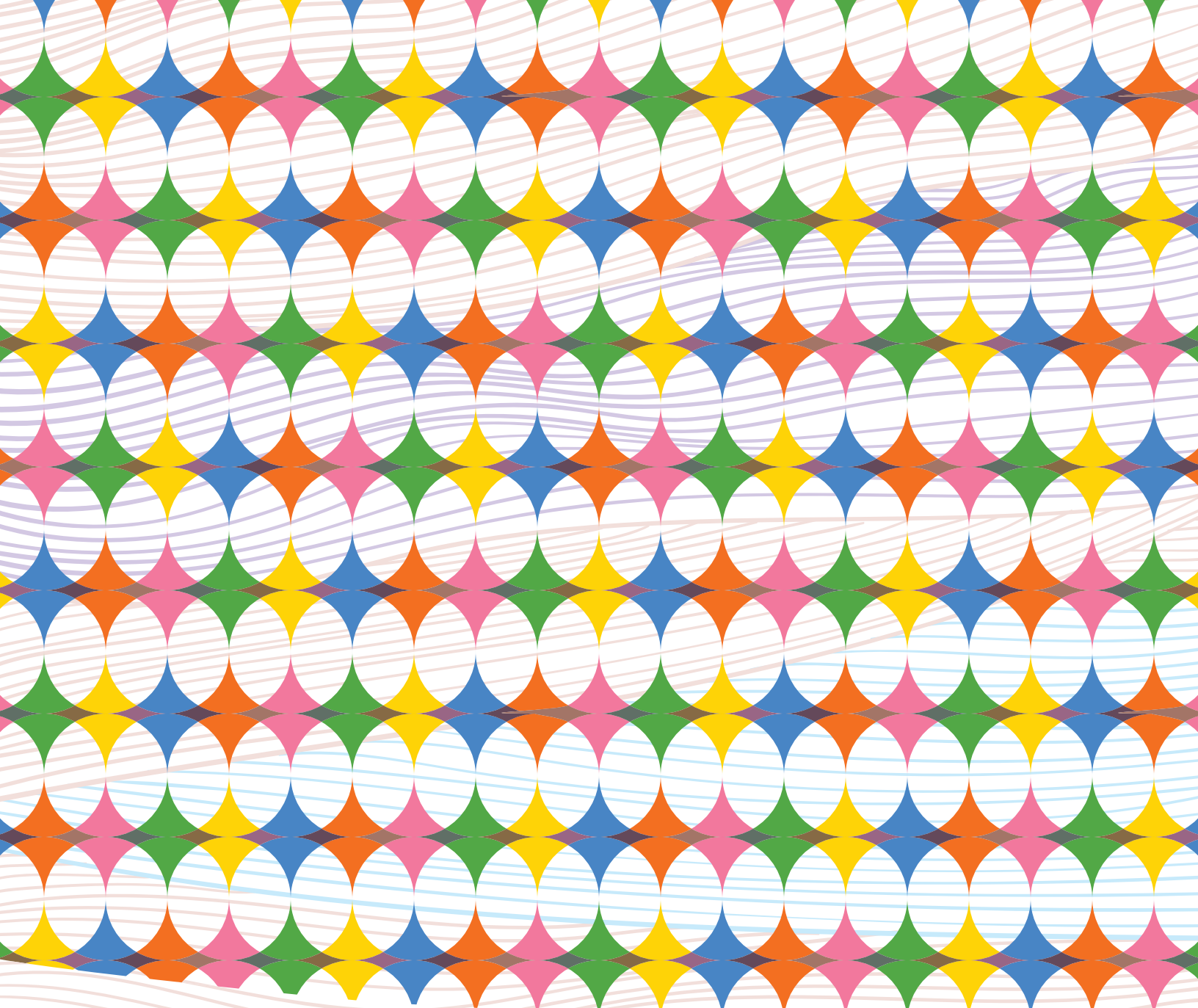

For the 2023 selling season



98098



The Mark of a Professional®

111031



SUPPLIER MEMBER

50195



unicorn 1

