

IKON™

—
Technical
Information
Pack



Vortex™
Spas

IKON™



JETS

18



WATER CAPACITY

1,159 litres



SEATING

6 seats



DIMENSIONS

3.64 x 2.25 x 0.90m



*Shown with Left Step option

FEATURES

Build

- Superior USA made Aristech™ acrylic
- Thermobond™ 4-layer shell construction
- Duraflex™ 'no kink' PVC plumbing
- EnduraLuxe™ AL Composite Panels

Water care

- Purezone™ pleated filtration
- Purezone™ Ozone water clarifier

Lighting

- Hydroglow™ underwater LED floodlight

Control

- SpaNet™ premium control systems

Hydrotherapy

- Ergonomic Hydrotherapy Loungers
- Individual jet pressure control
- Exclusive Vortex Hydroflow™ bearing-less jets

Optional Upgrades Included in Avanté

- Galvanised steel frame construction
- Purezone™ UV-C sanitiser
- ThermoLock™ Dual layer insulation
- Hydroglow™ jet lighting
- Hydroglow™ programmable lighting

Optional Extras

- SmartLINK™ Wifi connectivity
- SpaNet™ Hybrid heat pump compatible

WARRANTIES

| | |
|-------------------------------|----------|
| Frame | Lifetime |
| Shell structure..... | 10 yrs |
| Acrylic surface | 5 yrs |
| Jets, plumbing & heater | 5 yrs |
| Pumps & equipment | 2 yrs |
| Deck | 2 yrs |

* Conditions apply. Specifications may change without notice. Pictures may show options not available on all models.

IKON™

Heights

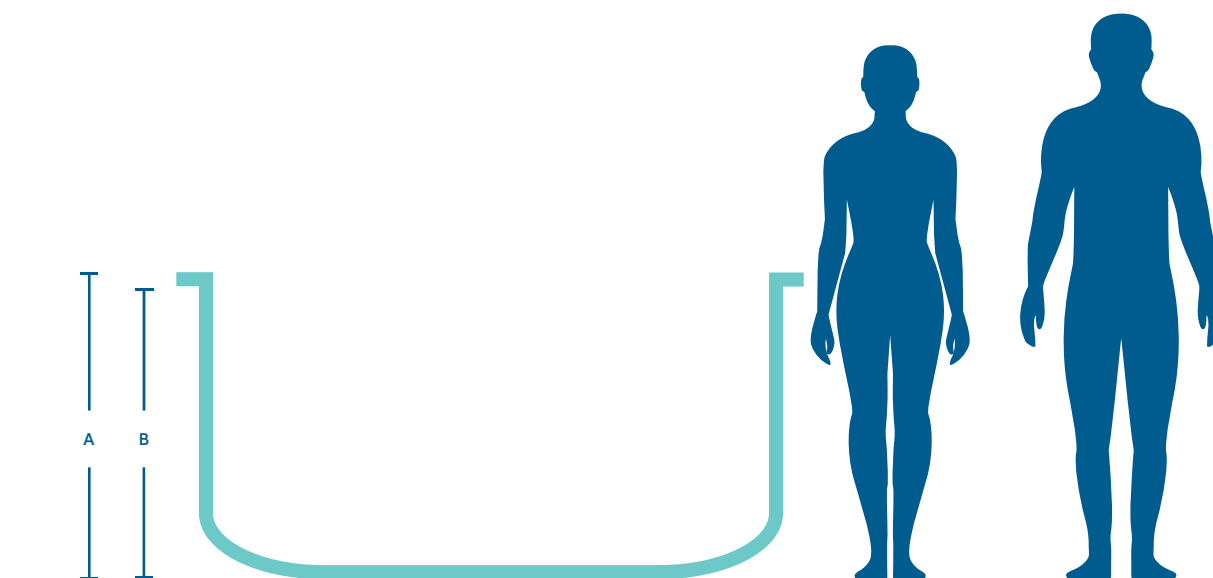

Illustration shows IKON™ spa model

| | | IKON™ |
|------------------|--|--------------------|
| Model dimensions | | 3.64(L) x 2.25(W)m |
| A | Total height +/-20mm | 0.90m |
| B | Product height to bottom of deck +/-20mm | 870mm |

* Conditions apply. Specifications may change without notice. Pictures may show options not available on all models.

IKON™

Jet specifications

Dimensions: 3.64 x 2.25 x 0.90m

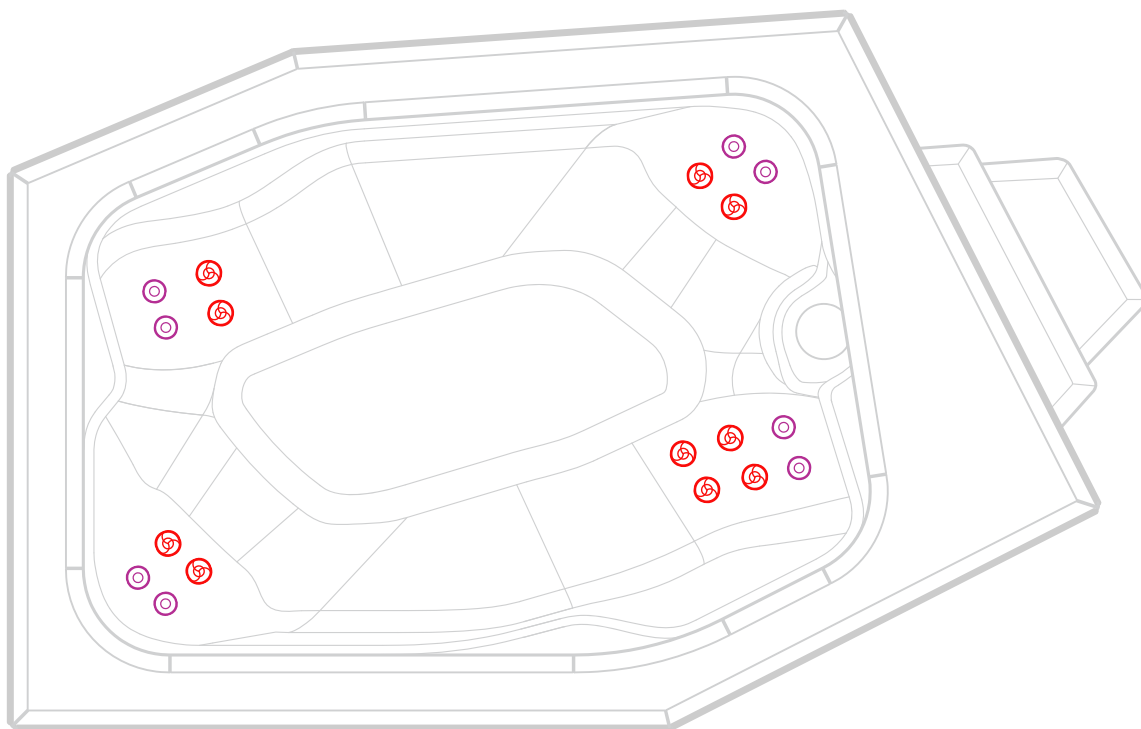

 10 x 100mm Single Jets

 8 x 100mm Directional Jets

* Conditions apply. Specifications may change without notice. Pictures may show options not available on all models.

IKON™

Specifications table

| | IKON™ |
|-------------------------------|---------|
| Water capacity | 1159L |
| Dry weight | 460kg |
| Filled weight (incl cover) | 1634kg |
| Lift weight | 550kg** |
| Intuitive spa controller | SV2 |
| Programmable circulation pump | 1 |
| Jet pumps | 1 |
| Variable output heater | 3kW max |
| Recommended electrical supply | 15 amps |

** The specified Lift weights in the table above include the spa's dry weight, packaging, and hard cover. These are approximate weights and are intended as a guide only. All weights must be checked by the crane operator prior to the lift. (Cranes have the ability to check the weight)

* Conditions apply. Specifications may change without notice. Pictures may show options not available on all models.

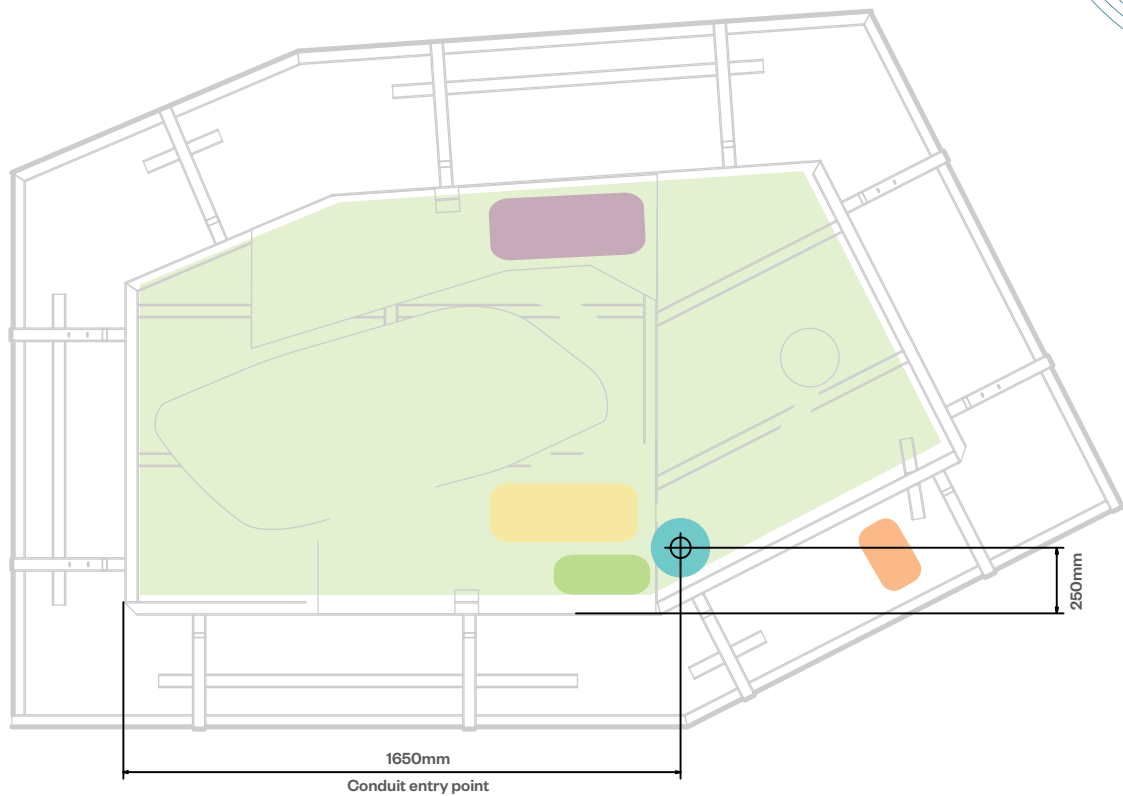
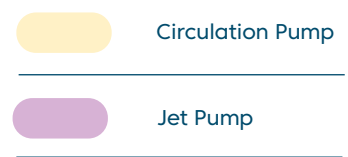
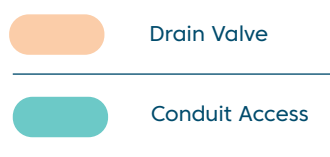
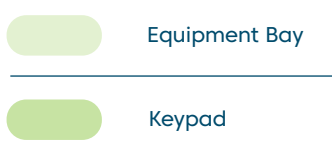

Illustration shows IKON™ spa pool model



* Conduit access should be no more than 100mm high above the concrete slab.

Note: This model has a rigid base, and if you choose to bring the piping conduit in from the bottom through the base, you will need to cut a hole into the base on-site before installation. The factory does not provide this hole. Please see the diagram above to find the location where you can drill the hole.

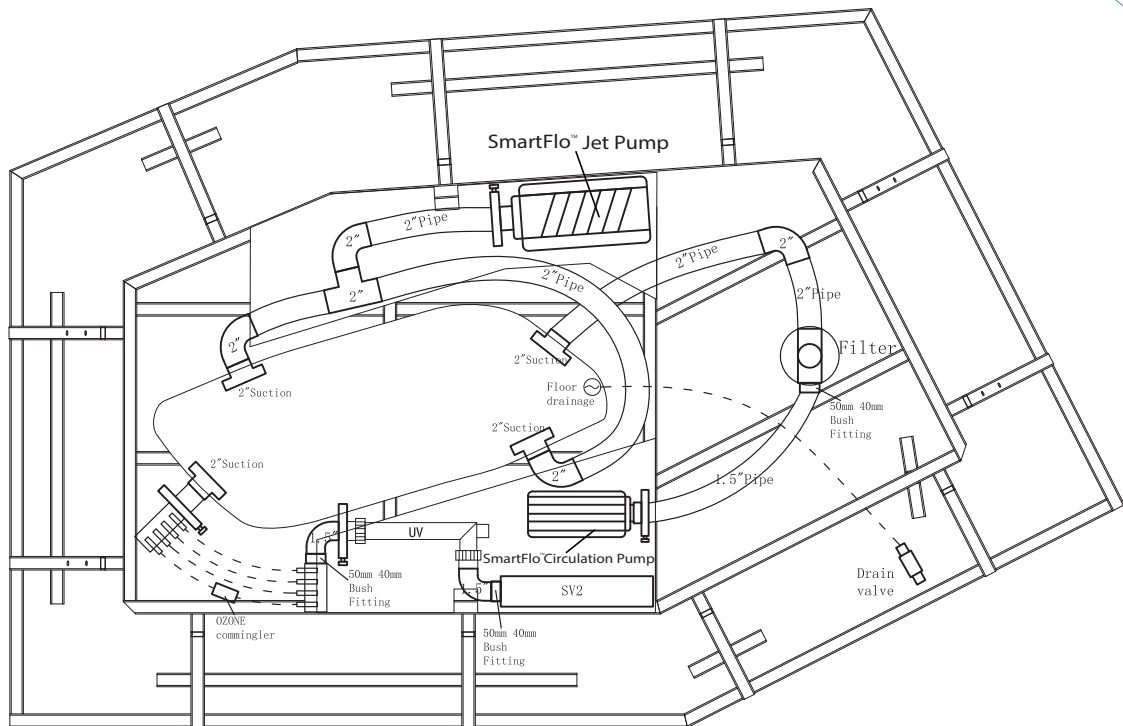

Illustration shows IKON™ spa pool model

* Conduit access should be no more than 100mm high above the concrete slab.

Note: This model has a rigid base, and if you choose to bring the piping conduit in from the bottom through the base, you will need to cut a hole into the base on-site before installation. The factory does not provide this hole. Please see the diagram above to find the location where you can drill the hole.

IKON™

Moving Specifications

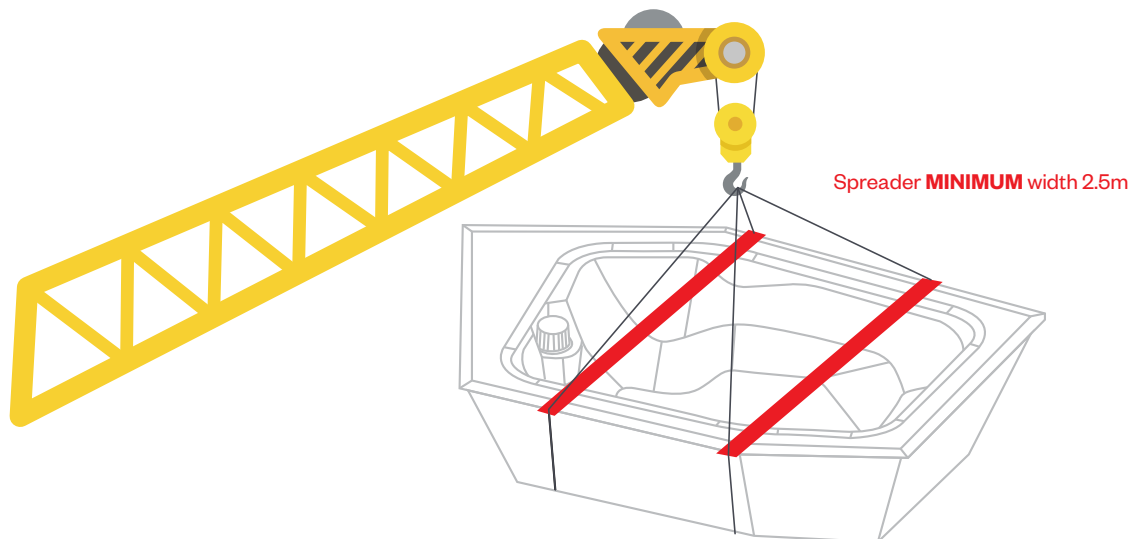

NEVER lift deck

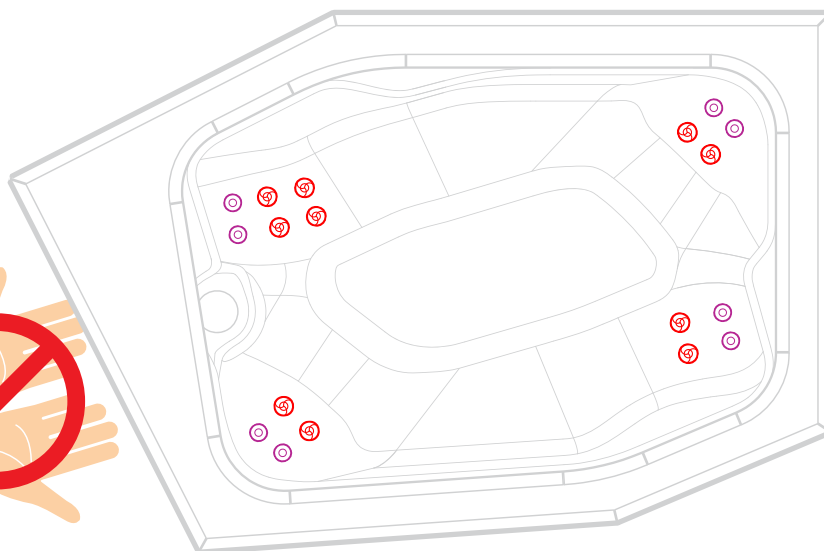

ALWAYS remove the cabinet panels and lift with the internal steel frame

IKON™

Steps Specifications and Installation

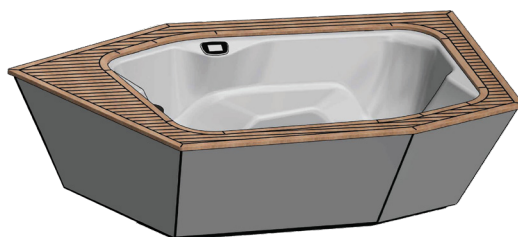

No Steps

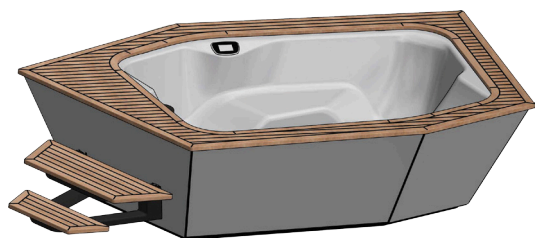

Optional Left Steps



Optional Right Steps

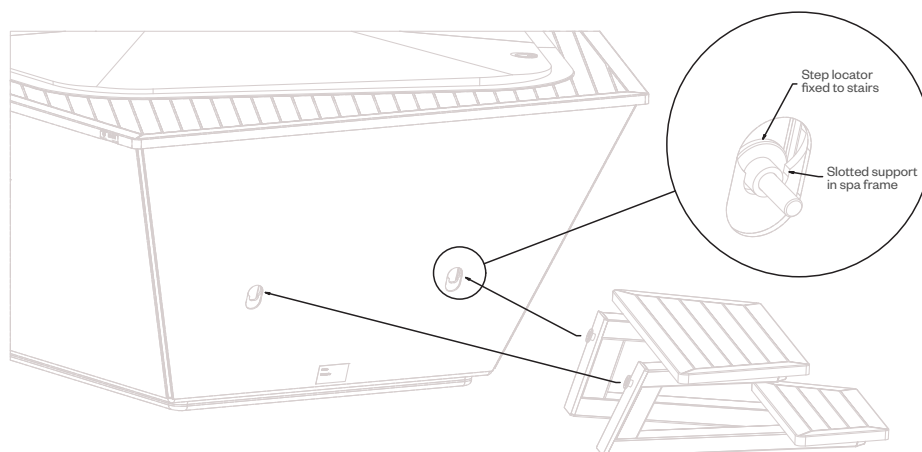

Step Installation:

1. Align the step locator with the slotted supports in the spa.
2. Push downward to secure in place.

Reverse sequence for removal.

* No step option will not include the two step locators

IKON™

Cover specifications

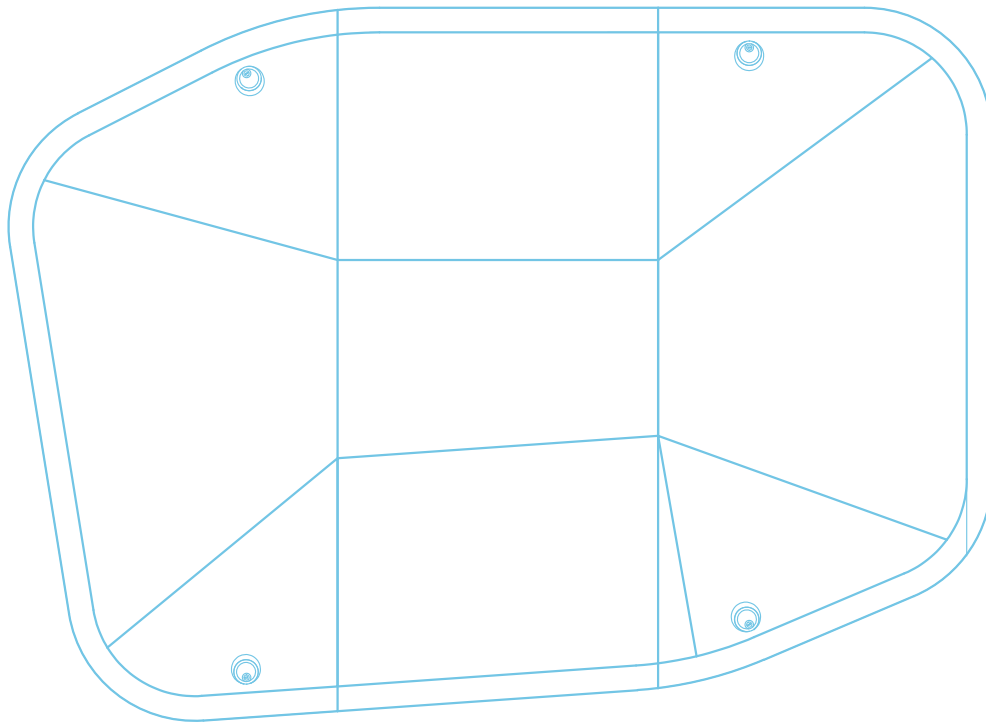

Foam cover assembly



Cover side view

IKON™

Cover specifications

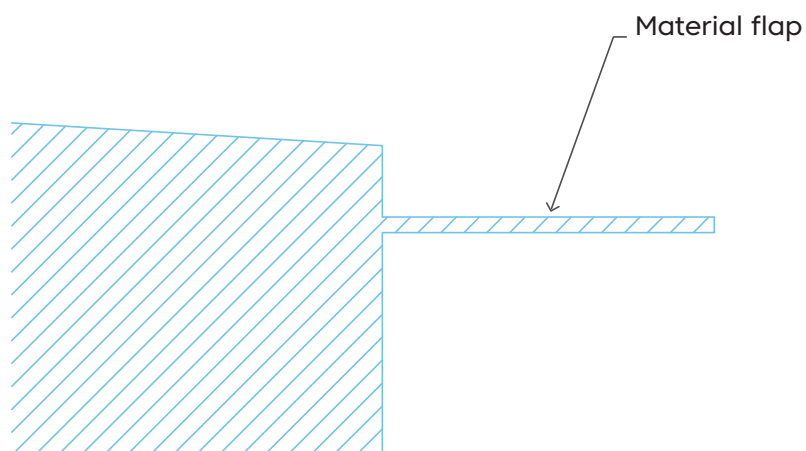

Cover side section

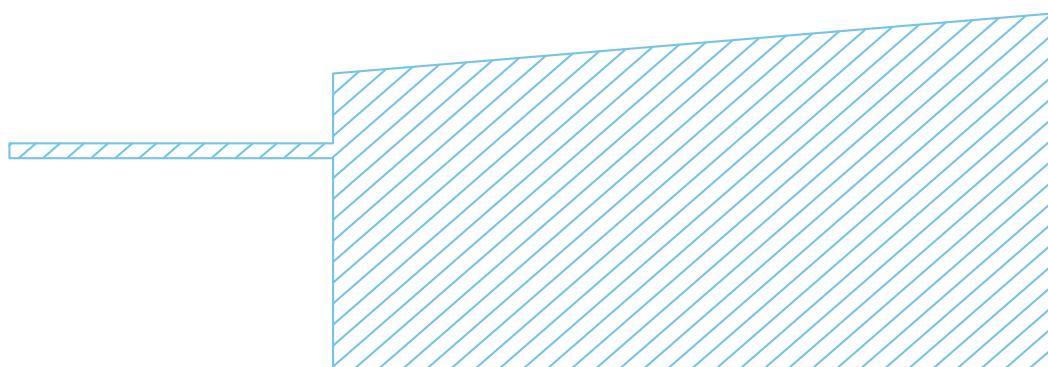

Cover side section

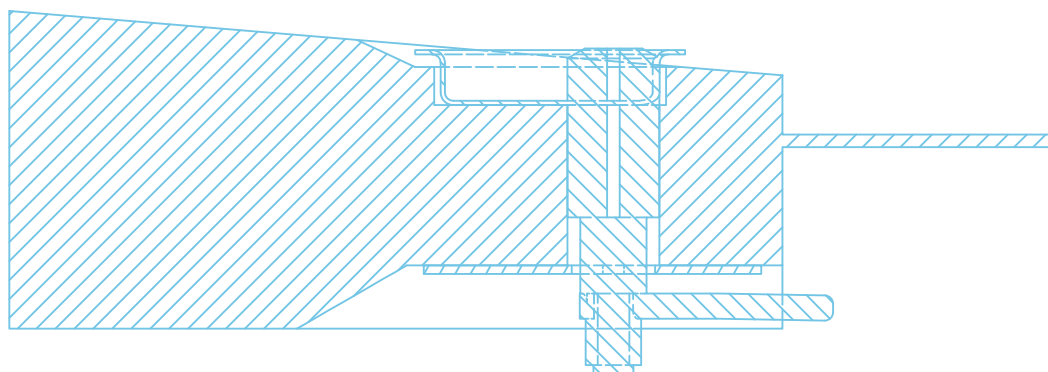

Lock side section

Vortex Spas™ Limited Warranty

Vortex Leisure Pty Ltd owns the Vortex Spas™ brand

Lifetime Warranty on Permaframe™ Frames

Vortex Leisure Pty Ltd warrants the structural integrity of the spa frame against defects in workmanship and materials for the lifetime of the spa subject to the limitations, conditions and exclusions expressed in this warranty.

10-year non pro rata structural warranty

Vortex Leisure Pty Ltd warrants the structure of the spa shell against defects in workmanship and materials leading to water loss from the spa for a period of 10 years from date of manufacture subject to the limitations and conditions expressed in this warranty.

5-year acrylic warranty

Vortex Leisure Pty Ltd warrants against the loss of water through the acrylic surface of the spa shell for a period of 5 years from date of manufacture, subject to limitations and conditions in this warranty.

5-year jet warranty

Vortex Leisure Pty Ltd warrants the removable spa jets to be free of manufacturing defects for a period of 5 years from date of manufacture. This warranty excludes damage by grit, sand and improper water chemistry causing corrosion of the part and is limited to supply of replacement parts after the faulty part has been returned to Vortex Leisure Pty Ltd for warranty inspection. Leaking from jets is covered by the plumbing warranty. Laminar jets have a 1 year parts only warranty.

5-year heater warranty

Vortex Leisure Pty Ltd warrants the heater element against defects in materials and workmanship for a period of 5 years from date of manufacture. After 1 year this warranty is limited to the supply of replacement parts and excludes labour and freight costs. This warranty does not cover damage to heaters caused by incorrect water balance resulting in the heater being subjected to abrasive/acid water.

5-year plumbing warranty

Vortex Leisure Pty Ltd warrants the plumbing piping and plumbing joints against defects in materials and workmanship causing leaking for a period of 5 years from date of manufacture. After 1 year this warranty is limited to the supply of replacement parts and excludes all labor and freight costs.

2-year pump warranty

Vortex Leisure Pty Ltd warrants the water pumps against defects in materials and workmanship for a period of 2 years from date of manufacture. After 1 year this warranty is limited to the supply of replacement parts and excludes all labour and freight costs. Damage to the pump motor caused by incorrect chemical balance will not be covered under this warranty. Vortex Leisure Pty Ltd reserves the right to request that the pump be returned for assessment before it is replaced under this warranty.

2-year electronic components warranty

Vortex Leisure Pty Ltd warrants electronic control systems against defects in materials and workmanship for a period of 2 years from date of manufacture. After 1 year the warranty is limited to the supply of replacement parts after the product has been assessed by either Vortex Leisure Pty Ltd or the relevant control system manufacturer.

1-year air blower warranty

Vortex Leisure Pty Ltd warrants the air blower against defects in materials and workmanship for a period of 1 year. This warranty will become void if the blower damage is caused by overfilling.

1-year thermoclad cabinet warranty

Vortex Leisure Pty Ltd warrants the thermoclad spa cabinet against defects in materials and workmanship for a period of 1 year from date of manufacture. This warranty specifically covers the structural integrity of the cabinet. The thermoclad cabinet finish is warranted to be free from defects in materials and workmanship at the time of initial delivery. Fading and weathering of the surface will occur naturally over time, and are not considered defects.

1-year Wifi, audio system, ozone, UV, LED light(s) warranty

Vortex Leisure Pty Ltd warrants the factory installed Wifi, audio system, UV sanitiser, Ozone sanitiser and LED Light(s) assemblies, to be free from defects in materials and workmanship for 1 year. The UV globe is a parts only warranty, if it fails within the 1 year period, a replacement globe will be sent out free of charge to be installed by the customer.

1-year external heat pump warranty

Vortex Leisure Pty Ltd warrants the External Heat Pump to be free from defects in materials and workmanship for 1 year. Installation is to be carried out by a qualified contractor. Failure to do so will immediately VOID this warranty. Vortex Leisure Pty Ltd reserves the right to request the return of the heat pump for assessment before it is replaced or repaired.

1-year spa hardcover warranty

Your Spa Cover is warranted for a period of 1 Year from the date of delivery. This warranty applies only to the structural integrity of the cover and the vinyl. Damage caused to stitching, straps or locks due to improper use of the cover will not be covered under warranty. Disposal of any cover replaced under warranty will be the owners responsibility.

Warranty coverage

Warranty coverage begins at the delivery date. Vortex Leisure Pty Ltd only extends this warranty to the original purchaser and only if the spa has been purchased through an authorized Vortex Leisure Pty Ltd reseller. Written notice of the defect and proof of purchase must be provided to Vortex Leisure Pty Ltd or it's nominated representative within 14 days of the defect occurring. If the spa is required to be returned to Vortex Leisure Pty Ltd for rectification all freight costs shall be pre paid by the customer. Repair or replacement of any defective product is at the sole discretion of Vortex Leisure Pty Ltd. To action warranty service contact the authorized Vortex Leisure Pty Ltd reseller you purchased from. If you are unable to obtain satisfactory service from your reseller, written notification must be provided to Vortex Leisure Pty Ltd within 14 days of the defect occurring. Vortex Leisure Pty Ltd will pay the travel costs of the service agent for the first 50km from their base. Any further travel charges shall be the responsibility of the spa owner.

Electrical connection

All electrical connections must be carried out by a qualified electrical contractor. Failure to do so will immediately VOID this warranty. The spa must be connected to a dedicated MAINS electrical supply circuit protected by a compliant earth leakage circuit breaker safety switch. Vortex Leisure Pty Ltd reserves the right to ask for proof that the spa has been installed by a qualified electrician.

Warranty exclusions

1. Damage resulting from improper water maintenance.
2. Damage from operating the spa above 45°C.
3. Damage caused by clogged filters
4. Damage caused to the spa by improper use of spa cover and excessive exposure to sunlight.
5. Acts of God.
6. Damage caused by not installing spa on sufficient hard level surface.
7. Damage caused by incorrect electrical installation, brownouts, voltage spikes or operating spa out of +/- 10% of voltage range.
8. Warranty is not extended to filter cartridges, head rests, pump seals or drain hoses.
9. Commercial use reduces all warranties to maximum 6 months.
10. Damage caused by relocation of the spa from its original installed location.
11. Damage by termites, borer or other pests.
12. Damage caused by flooding
13. Damage caused by third party carriers.
14. Damage or corrosion to frame caused by un-repaired leaks or improper drainage.

Limitations

This warranty is the only warranty offered by Vortex Leisure Pty Ltd and excludes any other implied or oral undertakings. Except as described above, this warranty does not cover defects or damage due to normal wear and tear, improper installation, alteration without Vortex Leisure Pty Ltd's prior written consent, accident, acts of God, misuse, abuse, commercial or industrial use, use of an accessory not approved by Vortex Leisure Pty Ltd, failure to follow Vortex Spas™ Pre-Delivery Instructions or Owner's Manual, or repairs made or attempted by anyone other than an authorized representative of Vortex Leisure Pty Ltd. Vortex Leisure Pty Ltd or its agents will not be liable for any incidental or consequential loss or injury. Vortex Leisure Pty Ltd will not be liable for costs associated with but not limited to building alterations, removal costs, delivery costs or labour costs associated with the replacement of a spa.

You must check and tighten all barrel unions regularly. Failure to do so may affect your warranty.
See your user manual for further information.

VSW030821



VortexTM
Spas