

GU LINE

cmatic[®]
P N E U M A T I C F I T T I N G S

快速接头
Couplings



GU 20

DN2.5快速接头

Coupling DN2,5

1	2	3	4	5	
本体 Body	阀芯 Valve	弹簧 Springs	密封圈 Seals	滚珠 Balls	接头 Plugs
UNI EN 12164 CW614N镀镍黄铜 Brass UNI EN 12164 CW614N Nickel plated	黄铜UNI EN 12164 CW614N Brass UNI EN 12164 CW614N	AISI 302不锈钢 Stainless Steel AISI 302	NBR NBR	AISI 420不锈钢 Stainless Steel AISI 420	UNI EN 12164 CW614N镀镍黄铜 Brass UNI EN 12164 CW614N Nickel plated

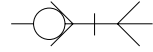
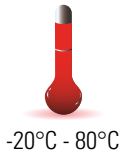

比例尺 1:1
Scale 1:1

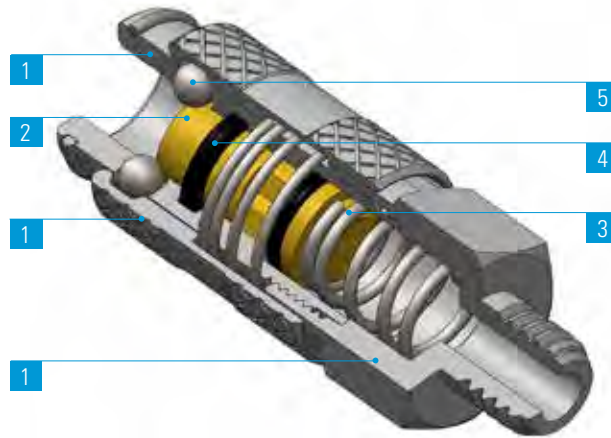

应用领域：
气动系统。

Application fields:
Pneumatic circuits.

GU 20-11

外螺纹接头体

Male Coupling

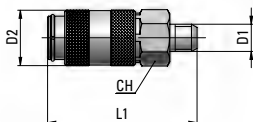

类型	D1	D2	L1	CH	g Δ
11 00 M5	M5x0.8	10	27	9	10
11 00 18	G1/8	10	29	12	14

GU 20-12

内螺纹接头体

Female Coupling

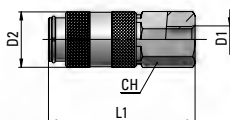

类型	D1	D2	L1	CH	g Δ
12 00 M5	M5x0.8	10	27	9	11
12 00 18	G1/8	10	29	12	15

GU 26-24

含保护弹簧的插头体

Plug with Hose Protection Spring

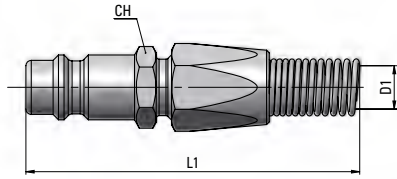

类型	D1	L1	CH	g $\Delta\Delta$
24 06 00	6x4	120	13	30
24 08 00	8x6	125	13	34
24 10 00	10x8	135	15	52.5

GU 20-13

软管用接头体

Coupling with Hose Connection

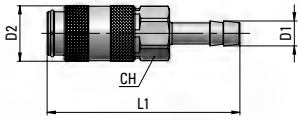

类型	管径 ϕ_i	D1	D2	L1	CH	g $\Delta\Delta$
13 03 00	3	3.6	10	36	9	9
13 04 00	4	4.6	10	36	9	10

GU 20-15

卡套接口接头体

Coupling with Nut Fitting

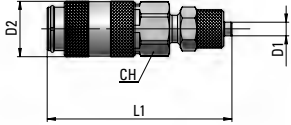

类型	D1	D2	L1	CH	g $\Delta\Delta$
15 04 00	4x2.5	10	33	9	11
15 06 00	6x4	10	35	9	13

GU 20-20

外螺纹插头体

Male Plug

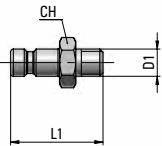

类型	D1	L1	CH	g $\Delta\Delta$
20 00 M5	M5x0.8	17	8	3
20 00 18	G1/8	20	12	7

GU 20-21

内螺纹插头体

Female Plug

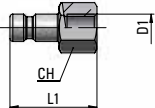

类型	D1	L1	CH	g $\Delta\Delta$
21 00 M5	M5x0.8	16	8	3
21 00 18	G1/8	19	12	6.5

GU 20-22

软管用插头体

Plug with Hose Connection

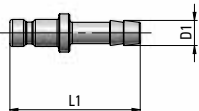

类型	管径 ϕ_i	D1	L1	g $\Delta\Delta$
22 03 00	3	3.6	24	2
22 04 00	4	4.6	24	2.5

GU 20-23

卡套式插头体

Plug with Nut Fitting

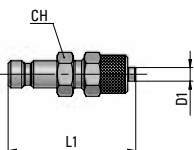

类型	D1	L1	CH	g $\Delta\Delta$
23 04 00	4x2.5	23	7	4
23 06 00	6x4	25	8	6

GU 21

DN5快速接头

Coupling DN5

1	2	3	4	5	
本体 Body	阀芯 Valve	弹簧 Springs	密封圈 Seals	滚珠 Balls	接头 Plugs
UNI EN 12164 CW614N镀镍黄铜 Brass UNI EN 12164 CW614N Nickel plated	UNI EN 12164 CW614N镀镍黄铜 Brass UNI EN 12164 CW614N Nickel plated	AISI 302不锈钢 Stainless Steel AISI 302	NBR NBR	AISI 420不锈钢 Stainless Steel AISI 420	UNI EN 12164 CW614N镀镍黄铜 Brass UNI EN 12164 CW614N Nickel plated

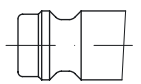
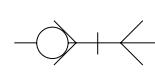
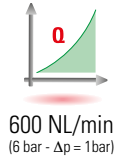

比例尺 1:1
Scale 1:1

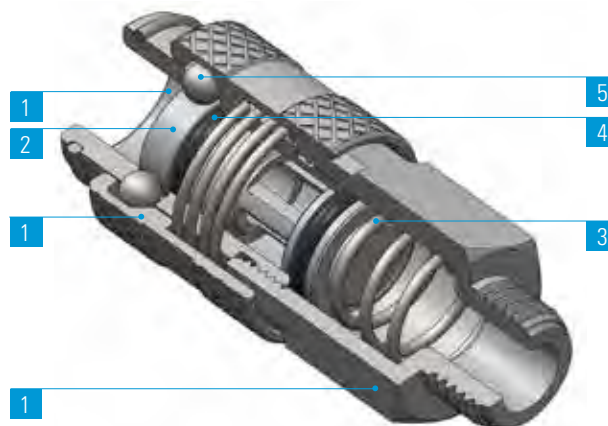

应用领域：
气动系统。

Application fields:
Pneumatic circuits.

GU 21-11

外螺纹接头体

Male Coupling

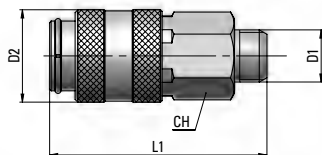

类型	D1	D2	L1	CH	g Δ
11 00 18	G1/8	16	40	14	27
11 00 14	G1/4	16	40	17	37

GU 21-12

内螺纹接头体

Female Coupling

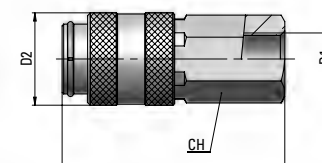

类型	D1	D2	L1	CH	g Δ
12 00 18	G1/8	16	40	14	35
12 00 14	G1/4	16	41	17	44.5

GU 21-13

软管用接头体

Coupling with Hose Connection

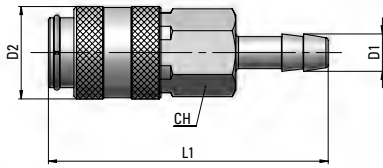

类型	管径 ϕ_i	D1	D2	L1	CH	g $\Delta\Delta$
13 04 00	4	5	16	50	14	25
13 06 00	6	7	16	50	14	32

GU 21-15

套入式接头体

Coupling with Nut Fitting

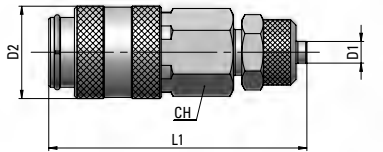

类型	D1	D2	L1	CH	g $\Delta\Delta$
15 06 00	6x4	16	47	14	37
15 08 00	8x6	16	48	14	38

GU 21-20

外螺纹插头体

Male Plug

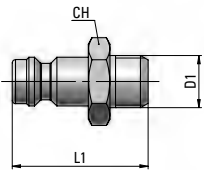

类型	D1	L1	CH	g $\Delta\Delta$
20 00 18	G1/8	25	14	11
20 00 14	G1/4	27	17	19

GU 21-21

内螺纹插头体

Female Plug

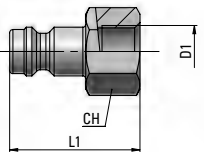

类型	D1	L1	CH	g $\Delta\Delta$
21 00 18	G1/8	25	14	13
21 00 14	G1/4	27	17	19

GU 21-22

软管用插头体

Plug with Hose Connection

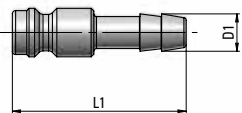

类型	管径 ϕ_i	D1	L1	g $\Delta\Delta$
22 04 00	4	5	32	6
22 06 00	6	7	32	6.5

GU 21-23

卡套式插头体

Plug with Nut Fitting

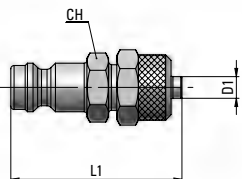



类型	D1	L1	CH	g $\Delta\Delta$
23 06 00	6x4	32	11	15
23 08 00	8x6	33	13	18

GU 21-24

含保护弹簧插头体

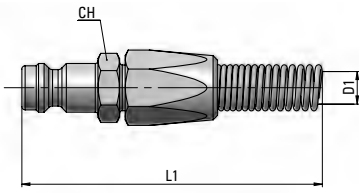
Plug with Hose Protection Spring



类型	D1	L1	CH	g 
24 06 00	6x4	110	11	24
24 08 00	8x6	120	13	31

1	2	3	4	5	
本体 Body	阀芯 Valve	弹簧 Springs	密封圈 Seals	滚珠 Balls	接头 Plugs
UNI EN 12164 CW614N镀镍黄铜 Brass UNI EN 12164 CW614N Nickel plated	UNI EN 12164 CW614N镀镍黄铜 Brass UNI EN 12164 CW614N Nickel plated	AISI 302不锈钢 Stainless Steel AISI 302	NBR NBR	AISI 420不锈钢 Stainless Steel AISI 420	UNI EN 12164 CW614N镀镍黄铜 Brass UNI EN 12164 CW614N Nickel plated

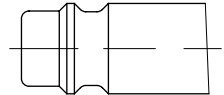
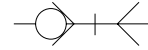
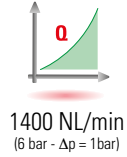
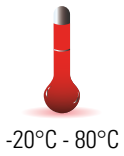

欧洲标准
European Profile

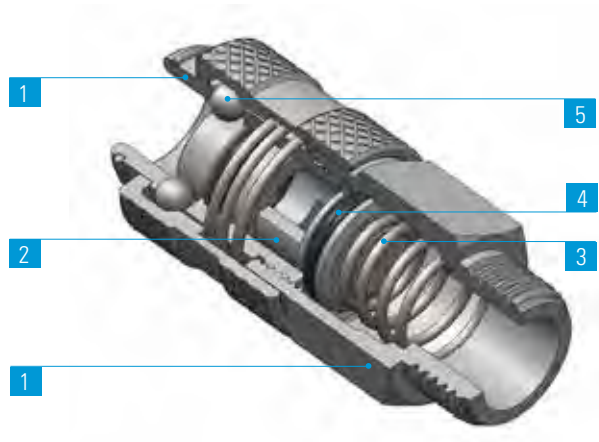

应用领域：
气动系统。

Application fields:
Pneumatic circuits.

GU 26-11

外螺纹接头体

Male Coupling

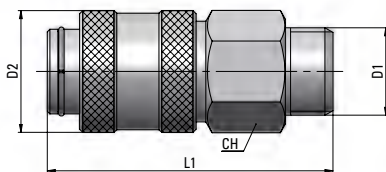

类型	D1	D2	L1	CH	g ΔΔ
11 00 14	G1/4	23	54	19	82
11 00 38	G3/8	23	54	20	89
11 00 12	G1/2	23	54	24	107

GU 26-12

内螺纹接头体

Female Coupling

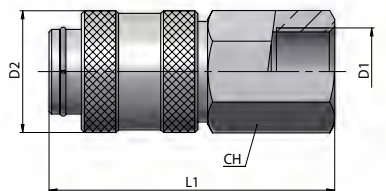

类型	D1	D2	L1	CH	g ΔΔ
12 00 14	G1/4	23	54	19	91
12 00 38	G3/8	23	54	20	90.5
12 00 12	G1/2	23	54	24	105

GU 26-13

软管用接头体

Coupling with Hose Connection

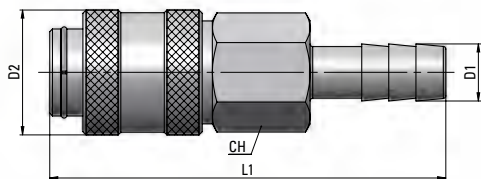

类型	管径 \varnothing	D1	D2	L1	CH	g $\Delta\Delta$
13 06 00	6	7.5	23	73	19	89
13 09 00	9	10.5	23	73	19	91
13 13 00	13	14.5	23	73	19	94

GU 26-15

卡套式接头体

Coupling with Nut Fitting

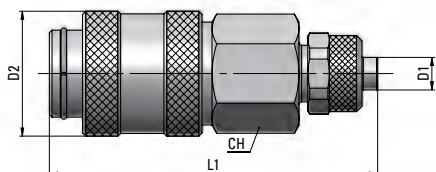

类型	D1	D2	L1	CH	g $\Delta\Delta$
15 08 00	8x6	23	60	19	89
15 10 00	10x8	23	61	19	103

GU 26-20

外螺纹插头体

Male Plug

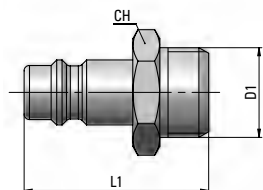

类型	D1	L1	CH	g $\Delta\Delta$
20 00 14	G1/4	33	17	22
20 00 38	G3/8	34	20	30
20 00 12	G1/2	37	24	50

GU 26-21

内螺纹插头体

Female Plug

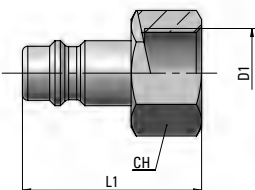

类型	D1	L1	CH	g $\Delta\Delta$
21 00 14	G1/4	33	17	24
21 00 38	G3/8	33	20	25
21 00 12	G1/2	36	24	40

GU 26-22

软管用插头体

Plug with Hose Connection

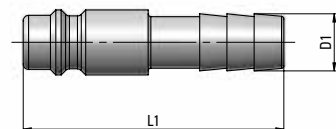

类型	管径 \varnothing	D1	L1	g $\Delta\Delta$
22 06 00	6	7.5	48	15
22 08 00	8	9.5	48	16
22 09 00	9	10.5	48	17
22 10 00	10	11.5	48	21
22 13 00	13	14.5	48	34

GU 26-23

卡套式插头体

Plug with Nut Fitting

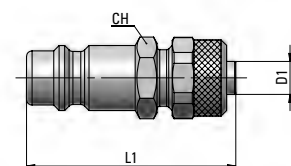

类型	D1	L1	CH	g $\Delta\Delta$
23 06 00	6x4	38	13	20
23 08 00	8x6	39	13	21
23 10 00	10x8	42	15	29

GU 10-11

多插座快速接头

Multi Socket Quick Coupling

1	2	3	4	5	GU 11
本体 Body	阀芯 Valve	弹簧 Springs	密封圈 Seals	滚珠 Balls	接头 Plugs
UNI EN 12164 CW614N 镀镍黄铜 Brass UNI EN 12164 CW614N Nickel plated	UNI EN 12164 CW614N 镀镍黄铜 Brass UNI EN 12164 CW614N Nickel plated	AISI 302 不锈钢 Stainless Steel AISI 302	NBR NBR	AISI 420 不锈钢 Stainless Steel AISI 420	镀镍钢 Nickel plated steel

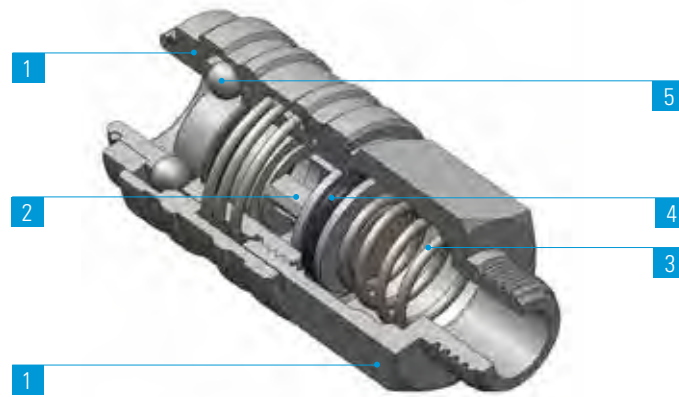
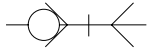

外形互换性
Suitable with following plugs profiles

流量
Flow rate (6 bar - Δp = 1 bar)

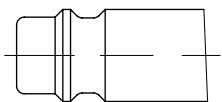

欧洲标准外形
European Profile

820

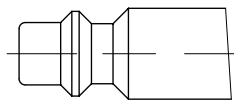

ISO 6150 B 标准外形
ISO 6150 B Profile

715

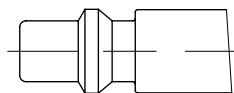

瑞典标准外形
Standard Swedisch Profile

725

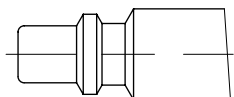

意大利标准外形
Standard Italian Profile

670

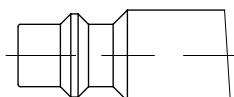

MIL C4109 标准外形
MIL C4109 Profile

715

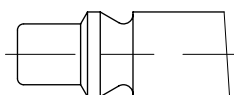

ARO 210 标准外形
ARO 210 Profile

705

比例尺 1:1 - Scale 1:1

GU 10-11

外螺纹接头体

Male Coupling

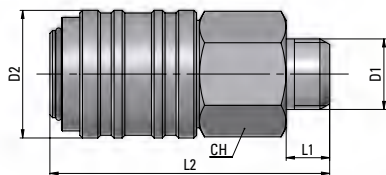

类型	D1	D2	L1	L2	CH	g $\Delta\Delta$
11 00 14	G1/4	23.5	10	52	20	88
11 00 38	G3/8	23.5	11	52	20	92
11 00 12	G1/2	23.5	11	52	24	118

GU 10-12

内螺纹接头体

Female Coupling

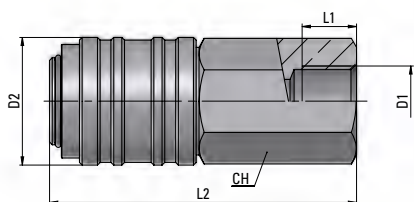

类型	D1	D2	L1	L2	CH	g $\Delta\Delta$
12 00 14	G1/4	23.5	10	57	20	109
12 00 38	G3/8	23.5	11	58	20	104
12 00 12	G1/2	23.5	11	60	24	134

GU 10-13

软管用接头体

Coupling with Hose Connection

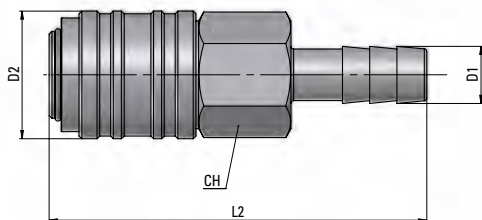

类型	管径 \varnothing_i	D1	D2	L2	CH	g $\Delta\Delta$
13 06 00	6	7.5	23.5	70	20	92
13 09 00	9	10.5	23.5	70	20	93
13 13 00	13	14.5	23.5	70	20	107

GU 11-20

外螺纹插头体 意大利标准外形

Male Plug, Italian profile

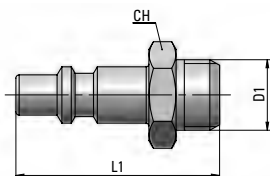

类型	D1	L1	CH	g $\Delta\Delta$
20 00 14	G1/4	37.5	14	17
20 00 38	G3/8	40	19	28
20 00 12	G1/2	40.5	24	43

GU 11-21

内螺纹插头体 意大利标准外形

Female Plug, Italian profile

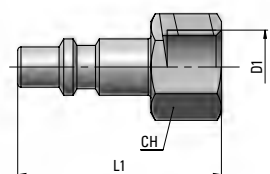

类型	D1	L1	CH	g $\Delta\Delta$
21 00 14	G1/4	39	17	23
21 00 38	G3/8	41	19	26
21 00 12	G1/2	44	25	51.1