

GU LINE



CN

快换接头

黄铜镀镍快换接头提供迷你型(直径2.5毫米)、标准型(直径5.0毫米)和欧规型(直径7.4毫米)三种尺寸;该产品系列也包含多路接头体型号。

EN

Couplings

Nickel-plated brass quick couplings available in mini (2.5 mm dia.), standard (5.0 mm dia.) and European (7.4 mm dia.) sizes; the product line also includes a multisocket version.

GU 20

DN2.5快速接头

Coupling DN2,5

- 1** 本体
Body

黄铜镀镍 UNI EN 12164 CW614N
Brass UNI EN 12164 CW614N, nickel plated
- 2** 阀芯
Valve

黄铜 UNI EN 12164 CW614N
Brass UNI EN 12164 CW614N
- 3** 弹簧
Springs

AISI 302 不锈钢
Stainless steel AISI 302
- 4** 密封圈
Seals

NBR
NBR
- 5** 滚珠
Balls

AISI 420 不锈钢
Stainless steel AISI 420
- i** 插头体
Plugs

黄铜镀镍 UNI EN 12164 CW614N
Brass UNI EN 12164 CW614N, nickel plated



-20° ÷ 80°C



35 bar



2,5 mm



170 NI/min
(6 bar - Δp = 1bar)



比例尺 1:1
Scale 1:1

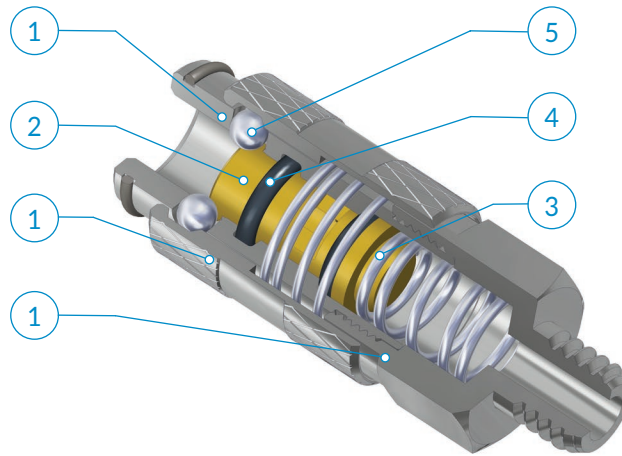

应用领域：
气动系统。

Application fields:
Pneumatic circuits

GU 20-11

外螺纹接头体

Male coupling

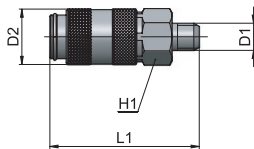

类型	D1	D2	L1	H1	g ΔΔ
11 00 M5	M5x0,8	10	27,5	9	10,0
11 00 18	G1/8	10	29	12	14,0



GU 20-12

内螺纹接头体

Female coupling

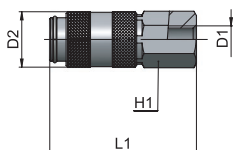

类型	D1	D2	L1	H1	g ΔΔ
12 00 M5	M5x0,8	10	27	9	11,0
12 00 18	G1/8	10	30,5	12	15,0



GU 20-13

软管用接头体

Coupling with hose connection

类型	ID1	D1	D2	L1	H1	g 
13 03 00	3	3,6	10	35,5	9	9
13 04 00	4	4,6	10	35,5	9	10

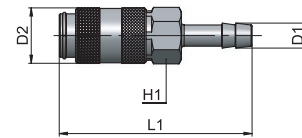

GU 20-15

快拧式接头体

Coupling with nut fitting

类型	D1	D2	L1	H1	g 
15 04 00	4x2,5	10	34	9	11,0
15 06 00	6x4	10	35	9	13,0

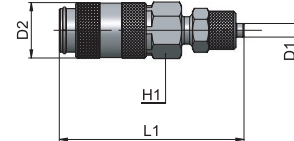

GU 20-20

外螺纹插头体

Male plug

类型	D1	L1	H1	g 
20 00 M5	M5x0,8	17	8	2,0
20 00 18	G1/8	20	12	6,0

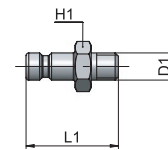

GU 20-21

内螺纹插头体

Female plug

类型	D1	L1	H1	g 
21 00 M5	M5x0,8	16	8	3,0
21 00 18	G1/8	19	12	6,0

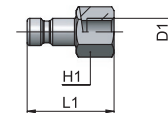

GU 20-22

软管用插头体

Plug with hose connection

类型	ID1	D1	L1	g 
22 03 00	3	3,6	24	2,0
22 04 00	4	4,6	24	2,0

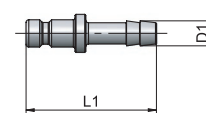

GU 20-23

快拧式插头体

Plug with nut fitting

类型	D1	L1	H1	g 
23 04 00	4x2,5	23,5	7	4,0
23 06 00	6x4	24,5	8	6,0

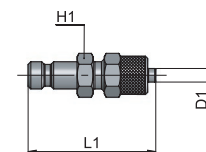

GU 21

DN5快换接头

Coupling DN5

- 1** 本体
Body

黄铜镀镍UNI EN 12164 CW614N
Brass UNI EN 12164 CW614N, nickel plated
- 2** 阀芯
Valve

黄铜镀镍UNI EN 12164 CW614N
Brass UNI EN 12164 CW614N, nickel plated
- 3** 弹簧
Springs

AISI 302 不锈钢
Stainless steel AISI 302
- 4** 密封圈
Seals

NBR
NBR
- 5** 滚珠
Balls

AISI 420 不锈钢
Stainless steel AISI 420
- i** 插头体
Plugs

黄铜镀镍UNI EN 12164 CW614N
Brass UNI EN 12164 CW614N, nickel plated



-20° ÷ 80°C



35 bar



5 mm



600 NI/min
(6 bar - Δp = 1bar)

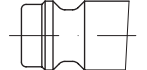
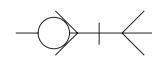

比例尺 1:1
Scale 1:1

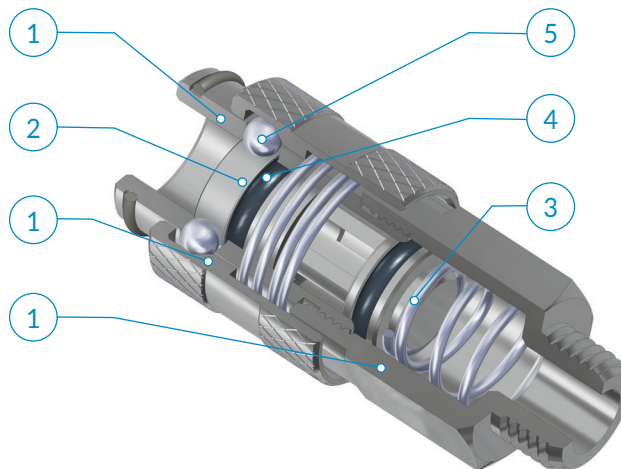

应用领域：
气动系统。

Application fields:
Pneumatic circuits

GU 21-11

外螺纹接头体

Male coupling

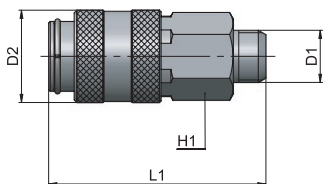

类型	D1	D2	L1	H1	g Δ
11 00 18	G1/8	17	40	14	33,5
11 00 14	G1/4	17	42	17	43,6



GU 21-12

内螺纹接头体

Female coupling

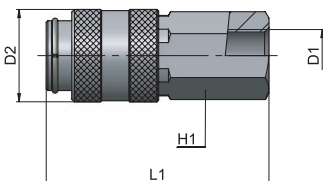

类型	D1	D2	L1	H1	g Δ
12 00 18	G1/8	17	41	14	37,0
12 00 14	G1/4	17	46	17	53,0



GU 21-13

软管用接头体

Coupling with hose connection

类型	ID1	D1	D2	L1	H1	g
13 04 00	4	4,9	17	51,5	14	34,0
13 06 00	6	6,9	17	51,5	14	35,1

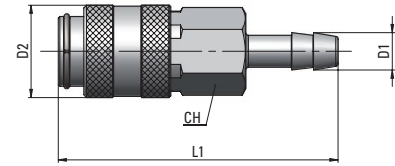

GU 21-15

快拧式接头体

Coupling with nut fitting

类型	D1	D2	L1	H1	g
15 06 00	6x4	17	47,5	14	38,0
15 08 00	8x6	17	48,5	14	39,7

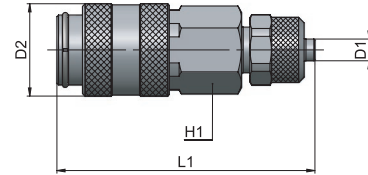

GU 21-20

外螺纹插头体

Male plug

类型	D1	L1	H1	g
20 00 18	G1/8	25	14	11,4
20 00 14	G1/4	27	17	19,0

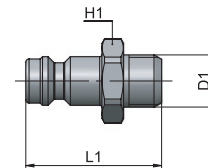

GU 21-21

内螺纹插头体

Female plug

类型	D1	L1	H1	g
21 00 18	G1/8	24	14	13,3
21 00 14	G1/4	27	17	19,7

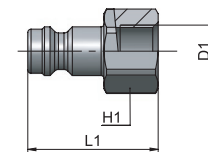

GU 21-22

软管用插头体

Plug with hose connection

类型	ID1	D1	L1	g
22 04 00	4	4,9	32	5,8
22 06 00	6	6,9	32	7,2

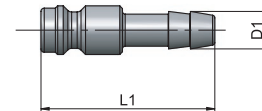

GU 21-23

快拧式插头体

Plug with nut fitting

类型	D1	L1	H1	g
23 06 00	6x4	31,5	11	15,1
23 08 00	8x6	32,5	13	20,2

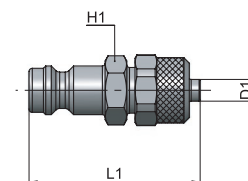

AP 55
AR 63
AV 221
CO 157
CX 255
EV 217
GU 119
GU Safety 135
GX 281
GX Safety 291
HP 317
MA 27
MB 41
MC 83
MF 235
MM 333
MO 93
MP 323
MT 339
MV 171
MX 241
MY 229
OX 261
PA 113
PE 79
PM 329
PN 67
PT 347
PU 131
PU Safety 149
PUX 287
PV 203
PVX 311
PX 249
QO 363
RA 101
RF 269
RT 355
RX 275
Tools 369
Tubings 375
VF 295
VT 359
VX 299

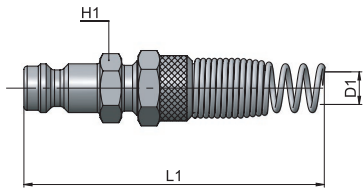

类型	D1	L1	H1	g
24 06 00	6x4	110	11	23,9
24 08 00	8x6	120	13	30,5



GU 26

DN7.4快换接头

Coupling DN7,4

- | | | | | | |
|--|---|---|--|---|--|
| <p>1 本体
Body</p> <p>黄铜镀镍 UNI EN 12164 CW614N
Brass UNI EN 12164 CW614N, nickel plated</p> | <p>2 阀芯
Valve</p> <p>黄铜镀镍 UNI EN 12164 CW614N
Brass UNI EN 12164 CW614N, nickel plated</p> | <p>3 弹簧
Springs</p> <p>AISI 302 不锈钢
Stainless steel AISI 302</p> | <p>4 密封圈
Seals</p> <p>NBR
NBR</p> | <p>5 滚珠
Balls</p> <p>AISI 420 不锈钢
Stainless steel AISI 420</p> | <p>i 插头体
Plugs</p> <p>黄铜镀镍 UNI EN 12164 CW614N
Brass UNI EN 12164 CW614N, nickel plated</p> |
|--|---|---|--|---|--|



-20° ÷ 80°C



35 bar



7,4 mm



1400 NI/min
(6 bar - Δp = 1bar)

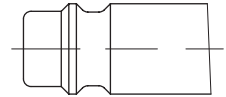
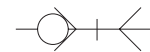

欧洲标准
European Profile

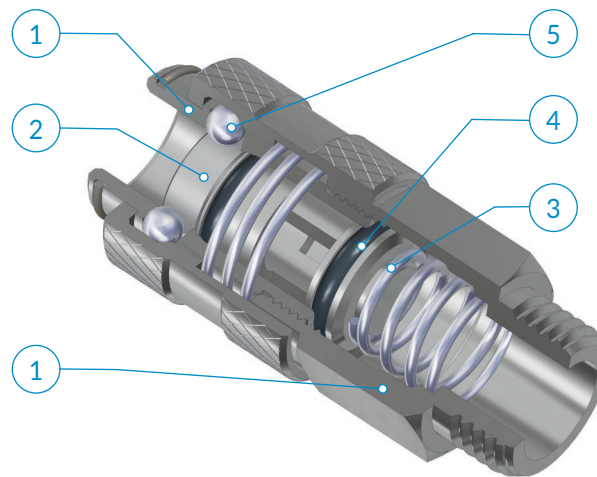

应用领域：
气动系统。

Application fields:
Pneumatic circuits

GU 26-11

外螺纹接头体

Male coupling

类型	D1	D2	L1	H1	g $\Delta\Delta$
11 00 14	G1/4	23	51,5	20	82,0
11 00 38	G3/8	23	51,5	20	89,0
11 00 12	G1/2	23	51,5	24	107,0

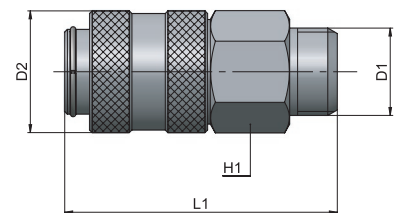

GU 26-12

内螺纹接头体

Female coupling

类型	D1	D2	L1	H1	g $\Delta\Delta$
12 00 14	G1/4	23	56,5	20	91,0
12 00 38	G3/8	23	58	20	90,0
12 00 12	G1/2	23	59,5	24	106,0

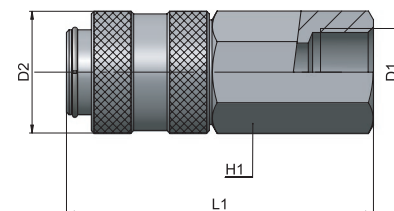

GU 26-13

软管用接头体

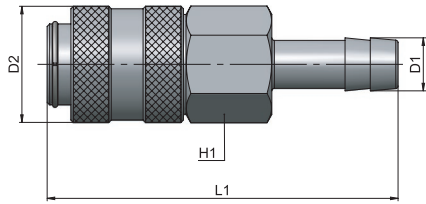

Coupling with hose connection

类型	ID1	D1	D2	L1	H1	g Δ
13 06 00	6	7,5	23	69,5	20	90,0
13 09 00	9	10,5	23	69,5	20	91,0
13 13 00	13	14,5	23	69,5	20	89,0



GU 26-15

快拧式接头体

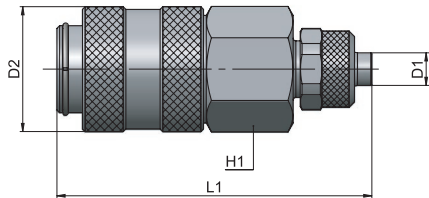

Coupling with nut fitting

类型	D1	D2	L1	H1	g Δ
15 08 00	8x6	23	58	20	90,0
15 10 00	10x8	23	60	20	91,0



GU 26-20

外螺纹插头体

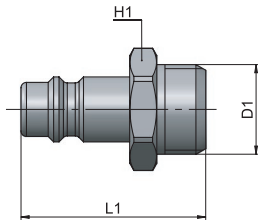

Male plug

类型	D1	L1	H1	g Δ
20 00 14	G1/4	33	17	22,0
20 00 38	G3/8	34	20	29,0
20 00 12	G1/2	37	24	50,0



GU 26-21

内螺纹插头体

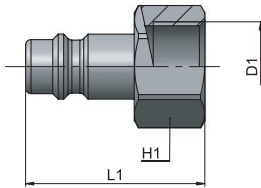

Female plug

类型	D1	L1	H1	g Δ
21 00 14	G1/4	33	17	23,5
21 00 38	G3/8	33	20	26,0
21 00 12	G1/2	37	24	39,0



GU 26-22

软管用插头体

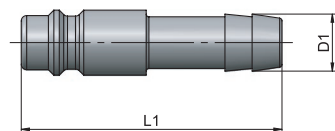

Plug with hose connection

类型	ID1	D1	L1	g Δ
22 06 00	6	7,5	48	14,0
22 08 00	8	9,5	48	16,0
22 09 00	9	10,5	48	18,0
22 10 00	10	11,5	48	20,0
22 13 00	13	14,5	48	34,0



GU 26-23

快拧式插头体

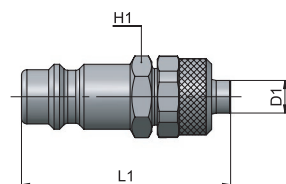

Plug with nut fitting

类型	D1	L1	H1	g Δ
23 06 00	6x4	37,5	13	20,0
23 08 00	8x6	38,5	13	22,0
23 10 00	10x8	41,5	15	29,0



类型	D1	L1	H1	g 
24 06 00	6x4	120	13	30,0
24 08 00	8x6	125	13	34,0
24 10 00	10x8	135	15	52,0

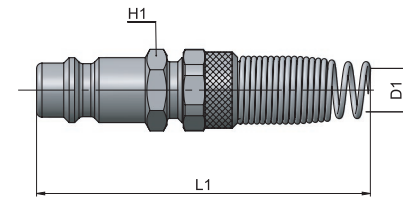

- AP 55
- AR 63
- AV 221
- CO 157
- CX 255
- EV 217
- GU 119
- GU Safety 135
- GX 281
- GX Safety 291
- HP 317
- MA 27
- MB 41
- MC 83
- MF 235
- MM 333
- MO 93
- MP 323
- MT 339
- MV 171
- MX 241
- MY 229
- OX 261
- PA 113
- PE 79
- PM 329
- PN 67
- PT 347
- PU 131
- PU Safety 149
- PUX 287
- PV 203
- PVX 311
- PX 249
- QO 363
- RA 101
- RF 269
- RT 355
- RX 275
- Tools 369
- Tubings 375
- VF 295
- VT 359
- VX 299

GU 10-11

多插座快换接头

Multi socket quick coupling

1 本体
Body

黄铜镀镍 UNI EN 12164 CW614N
Brass UNI EN 12164 CW614N, nickel plated

2 阀芯
Valve

黄铜镀镍 UNI EN 12164 CW614N
Brass UNI EN 12164 CW614N, nickel plated

3 弹簧
Springs

AISI 302 不锈钢
Stainless steel AISI 302

4 密封圈
Seals

NBR
NBR

5 滚珠
Balls

AISI 420 不锈钢
Stainless steel AISI 420

i 插头体
Plugs

黄铜镀镍
Brass nickel plated



-20° ÷ 80°C





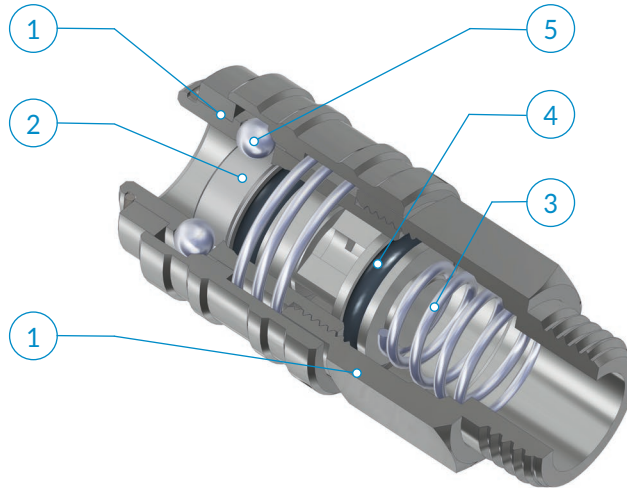
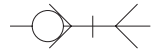

15 bar

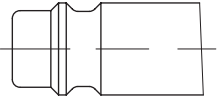
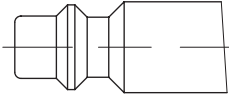
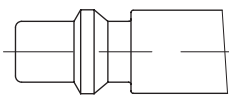

应用领域：
气动系统。

Application fields:
Pneumatic circuits

适用以下插头体外形 Suitable with following plugs profiles		流量 Flow rate
		NI/min (6 bar - Δp = 1bar)
	欧洲标准外形 European Profile	820
	ISO 6150 B标准外形 ISO 6150 B Profile	715
	瑞典标准外形 Standard Swedisch Profile	725
	意大利标准外形 Standard Italian Profile	670
	MIL C4109标准外形 MIL C4109 Profile	715
	ARO 210标准外形 ARO 210 Profile	705

比例尺 1:1 - Scale 1:1

GU 10-11

外螺纹接头体

Male coupling

类型	D1	D2	L1	L2	H1	g Δ
11 00 14	G1/4	23,5	10	51,5	20	90,0
11 00 38	G3/8	23,5	11	51,5	20	93,0
11 00 12	G1/2	23,5	11	51,5	24	118,0

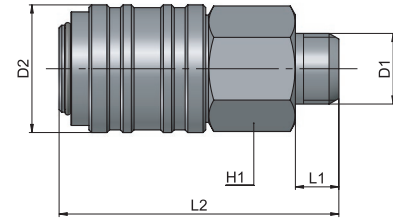

GU 10-12

内螺纹接头体

Female coupling

类型	D1	D2	L1	L2	H1	g Δ
12 00 14	G1/4	23,5	10	56,5	20	109,0
12 00 38	G3/8	23,5	11	58	20	103,0
12 00 12	G1/2	23,5	11	59,5	24	134,0

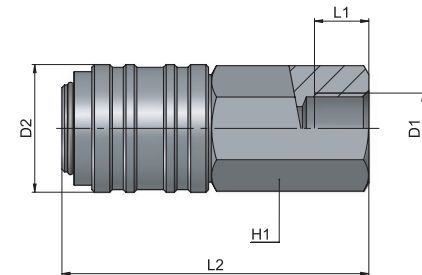

GU 10-13

软管用接头体

Coupling with hose connection

类型	D1	D2	L2	H1	g Δ
13 06 00	6	23,5	69,5	20	91,0
13 09 00	9	23,5	69,5	20	93,0
13 13 00	13	23,5	69,5	20	107,0

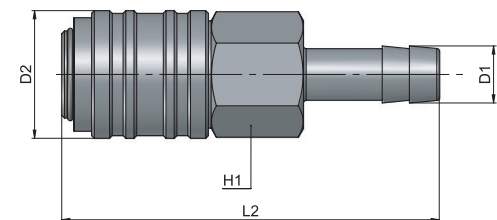

GU 11-20

外螺纹插头体 意大利标准外形

Male plug, italian profile

类型	D1	L1	H1	g Δ
20 00 14	G1/4	37,5	14	19,1
20 00 38	G3/8	40	19	28,0
20 00 12	G1/2	40,5	24	36,2

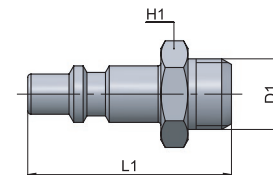

GU 11-21

内螺纹插头体 意大利标准外形

Female plug, italian profile

类型	D1	L1	H1	g Δ
21 00 14	G1/4	39	17	23,0
21 00 38	G3/8	41	19	26,0
21 00 12	G1/2	44	25	51,1

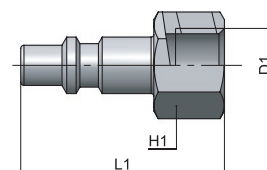



cmatic