

cmatic[®]
PNEUMATIC FITTINGS

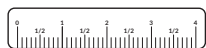

INCH



PUX LINE



CN

NPT 316L 不锈钢快换接头
NPT 螺纹不锈钢快换接头.

EN

316L Stainless Steel Couplings, NPT
Stainless steel quick couplings available with NPT threads.



PUX 10

不锈钢多插座快换接头

Stainless steel multi socket quick coupling

- 1 本体
Body

316L (1.4404) 不锈钢
Stainless steel AISI 316L (1.4404)
- 2 控制滑套
Command sleeve
- 3 阀芯
Valve
- 4 弹簧
Springs

AISI 302 不锈钢
Stainless steel AISI 302
- 5 滚珠
Balls

AISI 420 不锈钢
Stainless steel AISI 420
- 6 密封圈
Seals

FPM
FPM
- 插头体
Plugs

316L (1.4404) 不锈钢
Stainless steel AISI 316L (1.4404)



-20° ÷ 150°C



15 bar

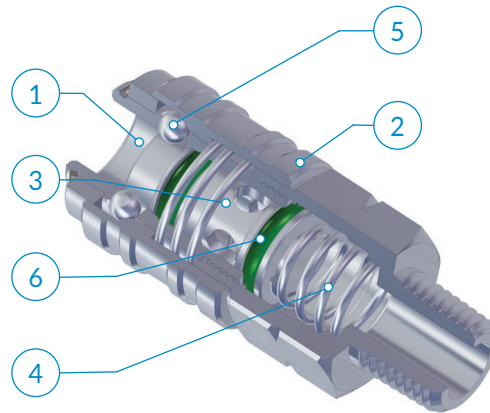

应用领域：
气动系统。

Application fields:
Pneumatic circuits

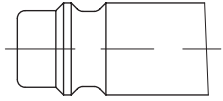
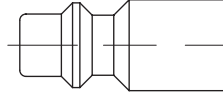
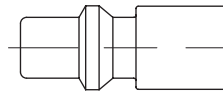
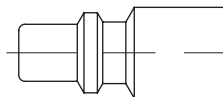
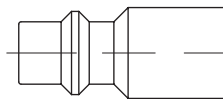
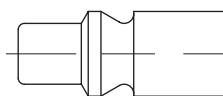
适用以下插头体外形 Suitable with following plugs profiles		流量 Flow rate
		NI/min (6 bar - Δp = 1bar)
	欧洲标准外形 European Profile	820
	ISO 6150 B标准外形 ISO 6150 B Profile	715
	瑞典标准外形 Standard Swedish Profile	725
	意大利标准外形 Standard Italian Profile	670
	MIL C4109标准外形 MIL C4109 Profile	715
	ARO 210标准外形 ARO 210 Profile	705

比例尺 1:1 - Scale 1:1

PUX 10-11

外螺纹接头体

Male coupling

类型	D1	D2	L1	L2	H1	g
11 00 14	1/4 NPTF	23,5	13	56,5	21	90,3
11 00 38	3/8 NPTF	23,5	13	55,5	21	91,8

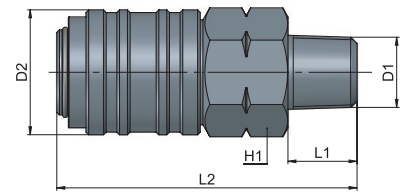

PUX 10-12

内螺纹接头体

Female coupling

类型	D1	D2	L1	L2	H1	g
12 00 14	1/4 NPTF	23,5	12,5	57,5	21	-
12 00 38	3/8 NPTF	23,5	12,5	58,5	21	-

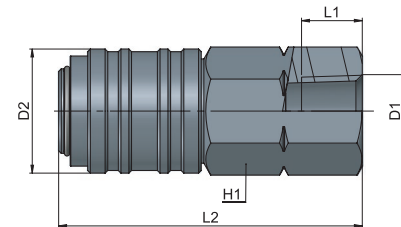

PUX 10-20

外螺纹插头体, ISO6150 B-12外形

Male plug according to ISO6150 B-12 profile

类型	D1	L1	H1	g
20 00 14	1/4 NPTF	42	14	23,3
20 00 38	3/8 NPTF	42	18	-

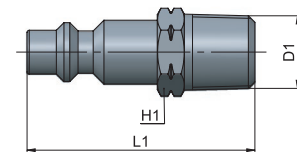

PUX 10-21

内螺纹插头体, ISO6150 B-12外形

Female plug according to ISO6150 B-12 profile

类型	D1	L1	H1	g
21 00 14	1/4 NPTF	41	17	-
21 00 38	3/8 NPTF	42	21	41,0

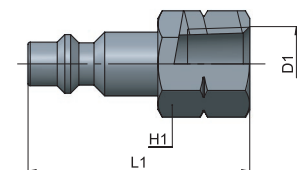

AP 55
AR 63
AV 221
CO 157
CX 255
EV 217
GU 119
GU Safety 135
GX 281
GX Safety 291
HP 317
MA 27
MB 41
MC 83
MF 235
MM 333
MO 93
MP 323
MT 339
MV 171
MX 241
MY 229
OX 261
PA 113
PE 79
PM 329
PN 67
PT 347
PU 131
PU Safety 149
PUX 287
PV 203
PVX 311
PX 249
QO 363
RA 101
RF 269
RT 355
RX 275
Tools 369
Tubings 375
VF 295
VT 359
VX 299

cmatic
P
N
W
U
M
A
T
T
E
W
E
R
T
R
A
N
S
P
A
R
E
N
C
E

cmatic