BuzziTripl Cockpit

Product Specification Sheet

This document contains technical information about the BuzziTripl Cockpit

·BUZZI
SPACE

www.buzzi.space







An instant getaway

Crafted from three layers of our hero BuzziFelt, BuzziTripl Cockpit is designed to reduce noise so you can establish a quiet and private area for concentration. The acoustic solution is easy to install and can be placed on any existing workstation or communal table. Or position more than one BuzziTripl Cockpit near each other to form a Hub for Togetherness, so employees can work apart together all while maintaining social distancing. The flexible and lightweight BuzziTripl Cockpit can work as a simple add-on to any workspace destination including co-shared offices, libraries, airports, and even hotel lobbies. Additionally, a functional cutout at the back allows chargers to run through without any clutter, so you can keep your laptop and smartphone always powered.

Design by BuzziSpace Studio

General

-  BuzziTripl Cockpit
-  Outside layers: BuzziFelt 6mm | 0.24" (both sides)
Core: Furniture Felt 6mm | 0.24"
Bicolor: BuzziFelt Anthracite and Offwhite
-  Dry Use
-  Flat Packed

Acoustics

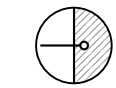

Absorption



Diffusion



Attenuation



Mid tone



High tone

Certifications



Content

Configurations	3
Components	3
Fabrics	4
Dimensions	5
Acoustics	6

Configurations

BuzziTripl Cockpit

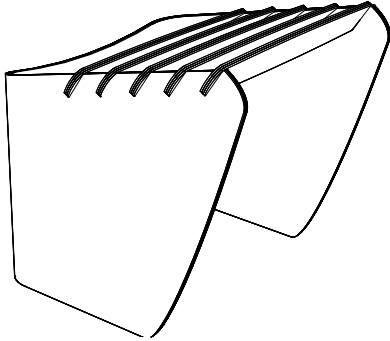

- 🌲 Outside layers: BuzziFelt 6mm | 0.24" (both sides)
Core: Furniture Felt 6mm | 0.24"
Bicolor: BuzziFelt Anthracite and Offwhite
- 📏 Length: 74 cm | 29.13"
Height: 77 cm | 30.31"
Width: 73 cm | 28.74"
- ⚖️ 5 kg | 11 lbs

Components

Bicolor

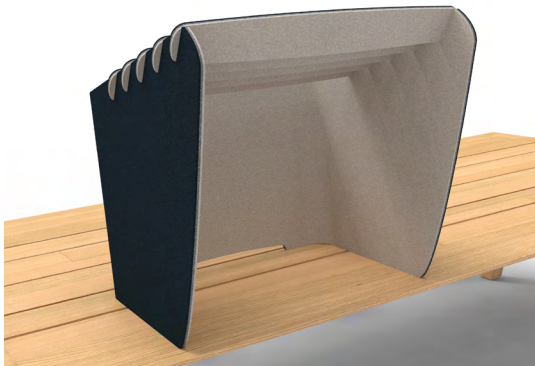

Always BuzziFelt Anthracite on one side and BuzziFelt Offwhite on the other side

Cut out



BuzziTripl Cockpit has a cut out for electrical wiring

Fabrics

Felt

Composition 100% Recycled P.E.T. Felt, latex backing

Weight 1.000 g/m2 | 29.49 oz/yd2

Abrasion resistance >7.000 Martindale

Flammability EU: EN 13501.1 + A1/2009 Class B-s1,d0
USA: ASTM E84 Class A certified

Fastness to light USA 5



FE-OffWhite 63

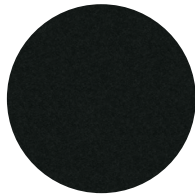

FE-Anthracite 68

Dimensions

BuzziTripl Cockpit

Thickness: 1,45 cm | 0.57"

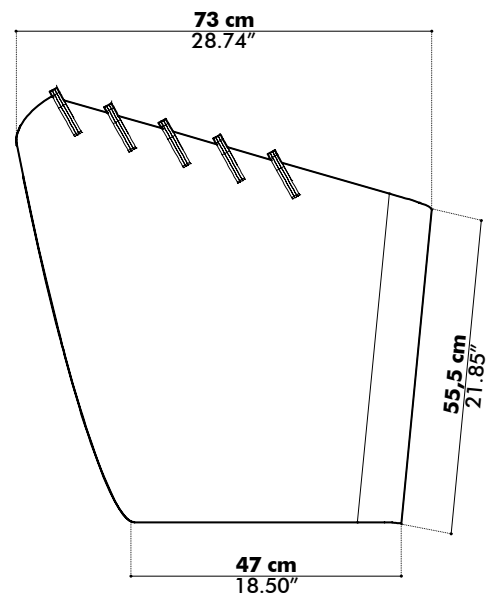
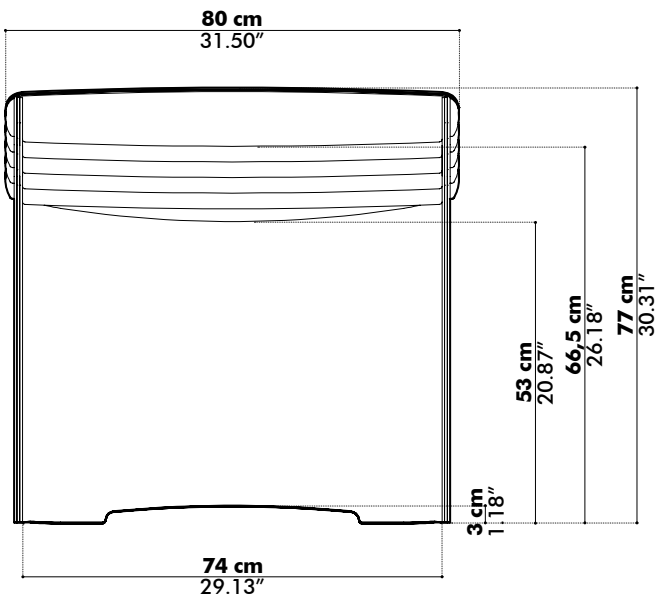
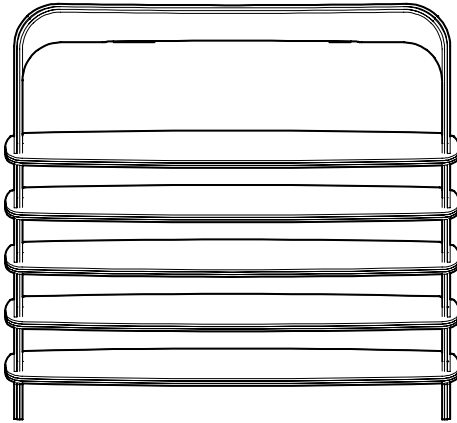

Acoustics

BuzziTripl Cockpit

Equivalent sound absorption area in m² per object

