

---

# BuzziPicNic

## product specification sheet

---

This documents contains technical information about the BuzziPicNic Desk, Meet, Side, Workbench, Bench & Round.

---



[www.buzzi.space](http://www.buzzi.space)



# The first indoor picnic table

Go ahead: have a PicNic in the office! Once again BuzziSpace is taking offices to a new level. But this time, in-house designer Alain Gilles is going a step further with the BuzziPicNic. Now you can work, have a meeting, stop for lunch or enjoy a beer with your coworkers at the same multifunctional table. Open the windows and get the barbecue going!

Design by Alain Gilles

---

## General

- ◆ Desk, Meet, Side, WorkBench, Bench, Round
- 🌲 Worktop: Wood or HPL  
Base: always Wood
- ☁️ Dry usage
- 🔧 Flat packed

---

## Certifications



PEFC™ PEFC/07-32-385



**BIFMA**



---

## Content

Configurations	3
Tabletop, Cable entry, Base	5
Finishes	6
Size Chart Tabletop Wood	7
Size Chart Tabletop HPL	9
Options	11
Electrification	12
Detailed dimensions	14
Weights	23
Wood Disclaimer	29

# Configurations

---

## BuzziPicNic Desk

- 📍 Desk Low, Desk High
- 🌲 Worktop: Wood or HPL  
Base: always Wood
- H: 75 cm (Desk Low) or 108 cm (Desk High)  
29.53"(Desk Low) or 42.52" (Desk High)
- ✂ L: 120, 140, 160, 180, 200, 220 or 240 cm  
47.24", 55.12", 62.99", 70.87", 78.74", 86.61" or 94.49"
- D: 80, 90 or 100 cm  
31.50", 35.43" or 39.37"
- ⋮ Cable entry always on the right  
Electrification and wire management optional

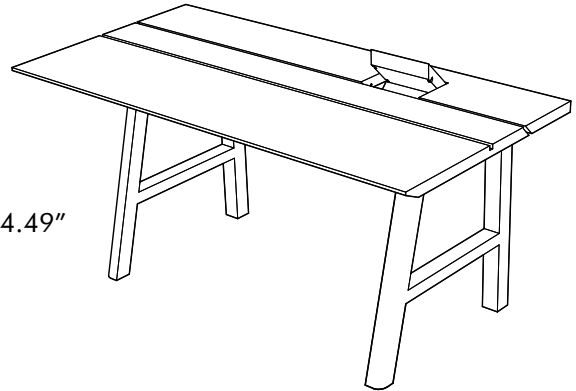

---

## BuzziPicNic Meet

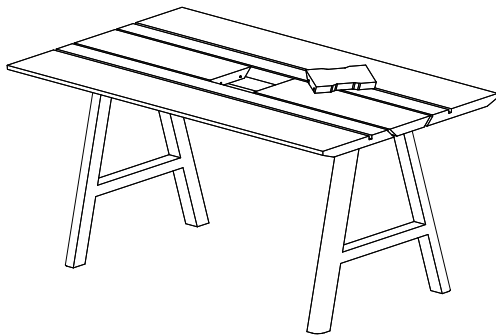

- 📍 Meet Low, Meet High
- 🌲 Worktop: Wood or HPL  
Base: always Wood
- H: 75 cm (Meet Low) or 108 cm (Meet High)  
29.53"(Meet Low) or 42.52" (Meet High)
- ✂ L: 160, 180, 200, 220 or 240 cm  
62.99", 70.87", 78.74", 86.61" or 94.49"
- D: 80, 90, 100 or 120 cm  
31.50", 35.43", 39.37" or 47.24"
- ⋮ Cable entry always in the middle  
Electrification and wire management optional

---

## BuzziPicNic Side

- 📍 Side Low, Side High
- 🌲 Worktop: Wood or HPL  
Base: always Wood
- H: 75 cm (Side Low), 108 cm (Side High)  
29.53"(Meet Low) or 42.52" (Meet High)
- ✂ L: 160, 180, 200, 220 or 240 cm  
62.99", 70.87", 78.74", 86.61" or 94.49"
- D: 50 cm  
19.69"
- ⋮ No cable entry
- ⚠ To be mounted against a wall

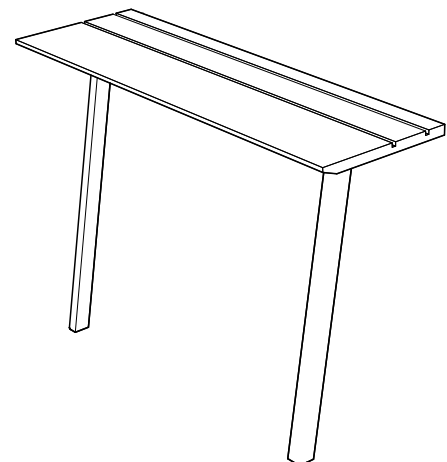

---

## BuzziPicNic WorkBench

- 🌲 Worktop: Wood or HPL  
Base: always Wood
- ✂ H 75 cm, L 320 cm, D 160 cm  
H 29.53", L 125.98", D 62.99"
- ... 4 x cable entry  
Electrification and wire management optional

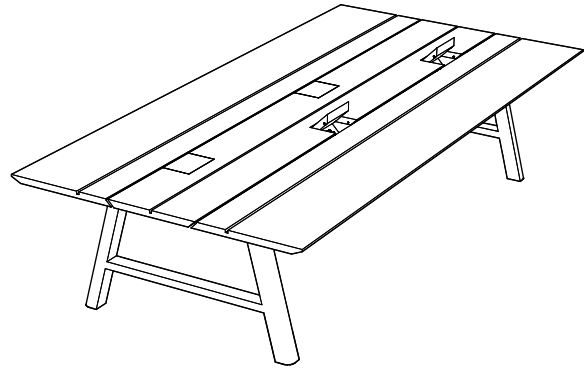

---

## BuzziPicNic Bench

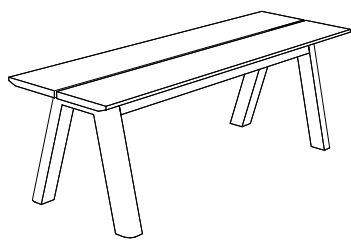

- 🌲 Top: Wood  
Base: Wood
- ✂ H 45 cm, L 116 or 136 cm, D 41,5 cm  
H 17.72", L 45.67" or 53.54", D 16.34"
- ... Cushion optional

---

## BuzziPicNic Round

- 🌲 Top: Wood  
Base: Wood
- ✂ H 75 cm, Ø 160 or 200 cm  
H 29.53", Ø 63 or 78.75"
- ... Cable entry  
Electrification and wire management optional

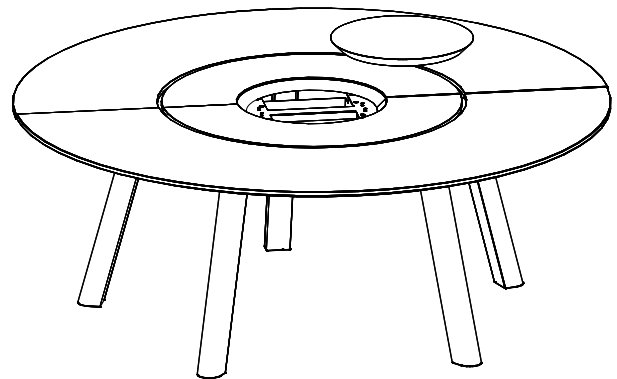

# Tabletop

## Wood

Table thickness 35 mm | 1.38"  
Front edge chamfered at 70° angle



## HPL\*

Table thickness 25 mm | 0.98"  
Front edge finished with ABS brim



\* Not available for Picnic round

# Cable Entry

## Tabletop Wood

Cable entry and wooden cable entry cover always integrated in the worktop. (except for BuzziPicNic Side and Meet depth 80 cm | 31.50")  
For PicNic Meet, PicNic Desk and PicNic Workbench

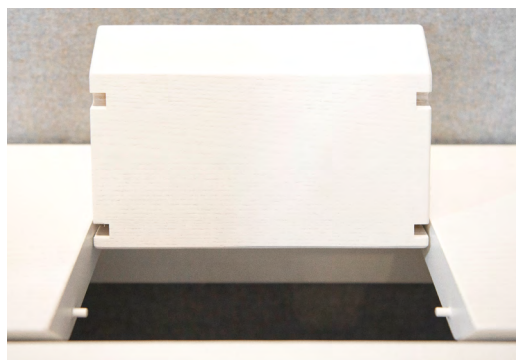

## Tabletop HPL

Cable entry cutout optional.  
Cable entry cover optional, available in white, black and alu. (not possible for BuzziPicNic Side and Meet depth 80 cm | 31.50")

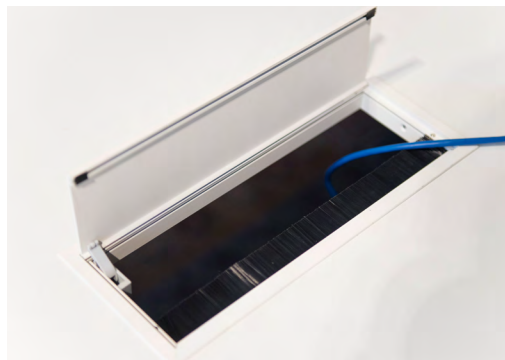

## For Picnic Round

Cable entry solid



Cable entry hinged



## Base

The BuzziPicNic Base is always made of wood (Ash or Oak). See page 6 for finishes.

# Finishes

---

## Wood

for Base and Tabletop



Ash Natural



Ash Black Stained



Ash WhiteWash



Ash Walnut Stained



Oak

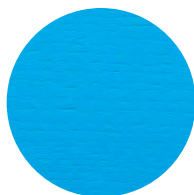

Ash Lacquered  
Blue



Ash Lacquered  
Green



Ash Lacquered  
Red



Ash Lacquered  
Yellow



Ash Lacquered  
White

---

## HPL\*

for Tabletop only



Pearl White

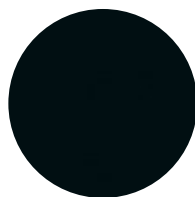

Volcanic Black

\* Not available for Picnic round

# Size Chart Tabletop Wood



## BuzziPicNic Desk Height 75 or 108 cm | 29.53" or 42.52"

	120 cm 47.24"	140 cm 55.12"	160 cm 62.99"	180 cm 70.87"	200 cm 78.74"	220 cm 86.61"	240 cm 94.49"
<b>80 cm</b> 31.50"							
<b>90 cm</b> 35.43"							
<b>100 cm</b> 39.37"							



## BuzziPicNic Meet Height 75 or 108 cm | 29.53" or 42.52"

	160 cm 62.99"	180 cm 70.87"	200 cm 78.74"	220 cm 86.61"	240 cm 94.49"
<b>*80 cm</b> 31.50"					
* this size is only available for BuzziPicNic Meet High and always without cable entry					
<b>90 cm</b> 35.43"					
<b>100 cm</b> 39.37"					
<b>120 cm</b> 47.24"					

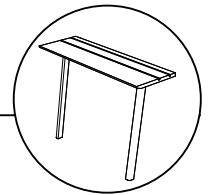

## BuzziPicNic Side Height 75 or 108 cm | 29.53" or 42.52"

	160 cm 62.99"	180 cm 70.87"	200 cm 78.74"	220 cm 86.61"	240 cm 94.49"
<b>50 cm</b> 19.69"					

---

**BuzziPicNic WorkBench** Height 75 cm | 29.53"

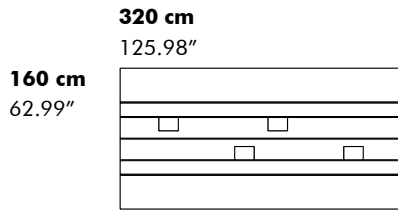
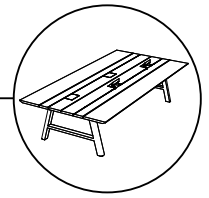

---

**BuzziPicNic Bench** Height 45 cm | 17.72"

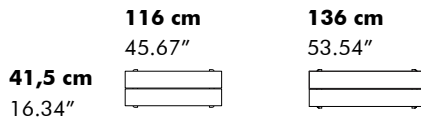
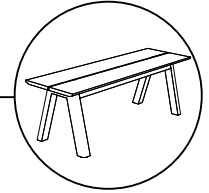

---

**BuzziPicNic Round** Height 75 cm | 29.53"

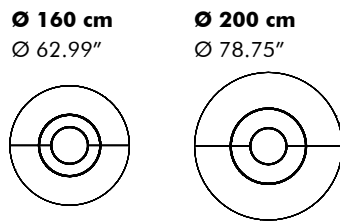
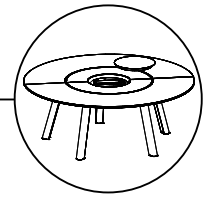



# Size Chart Tabletop HPL

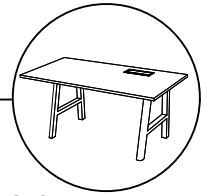

## BuzziPicNic Desk Height 75 or 108 cm | 29.53" or 42.52"

	120 cm 47.24"	140 cm 55.12"	160 cm 62.99"	180 cm 70.87"	200 cm 78.74"	220 cm 86.61"	240 cm 94.49"
<b>80 cm</b> 31.50"							
<b>90 cm</b> 35.43"							
<b>100 cm</b> 39.37"							

\* Optional

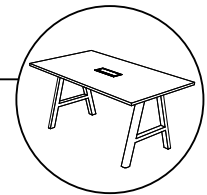

## BuzziPicNic Meet Height 75 or 108 cm | 29.53" or 42.52"

	160 cm 62.99"	180 cm 70.87"	200 cm 78.74"	220 cm 86.61"	240 cm 94.49"
<b>*80 cm</b> 31.50"					
* this size is only available for BuzziPicNic Meet High and always without cable entry					
<b>90 cm</b> 35.43"					
<b>100 cm</b> 39.37"					
<b>120 cm</b> 47.24"					

\* Optional

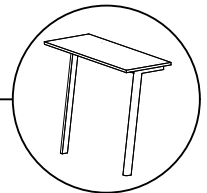

## BuzziPicNic Side Height 75 or 108 cm | 29.53" or 42.52"

	160 cm 62.99"	180 cm 70.87"	200 cm 78.74"	220 cm 86.61"	240 cm 94.49"
<b>50 cm</b> 19.69"					

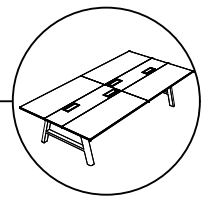

---

**BuzziPicNic WorkBench** Height 75 cm | 29.53"

**320 cm**  
125.98"

**160 cm**  
62.99"

# Options

---

## Cushion for BuzziPicNic Bench



Available in Fabric, Trevira CS+, Trevira CS, Revive 1, Clara 2, Remix 3, Velvet, Hero 2, Tonus 4, Memory 2  
(check colours online: [www.buzzi.space](http://www.buzzi.space))

## Desk High Connect Panel for BuzziPicNic Desk High

The Desk High Connect Panel combines the BuzziPicNic Desk High and the Desk Low in one configuration. Connect Panel can be mounted to the BuzziPicNic Desk High. Connection brackets and screws are included.

Available in Wood or BuzziFelt

(check colours online: [www.buzzi.space](http://www.buzzi.space))



- ✘ H 33 cm, L 120, 140, 160, 180, 200, 220, 240 cm, D 3,5 cm (Wood) or 1,2 cm (Felt)
- ✘ H 12.99", L 47.2, 55.1, 63.00, 70.90, 78.70, 86.60 or 94.50", D 1.38" (Wood) or 0.47" (Felt)

## BuzziDesk FlipFlop for BuzziPicNic Wood



Combine the BuzziDesk FlipFlop with BuzziPicNic: screw the 2 sliders into the BuzziDesk FlipFlop and put them into the BuzziPicNic-ridge.

Available in BuzziFabric

More information and sizes: check [www.buzzi.space/buzzidesk-flipflop](http://www.buzzi.space/buzzidesk-flipflop)

# Electrification (optional)

The Cable Box provides power outlets and/or USB and data connections for a BuzziPicNic Desk, Meet, WorkBench and round. Cables and cable management are included in this Cable Box.

## Cable Box Single

for PicNic Desk, PicNic Meet  
(includes all items as listed below)

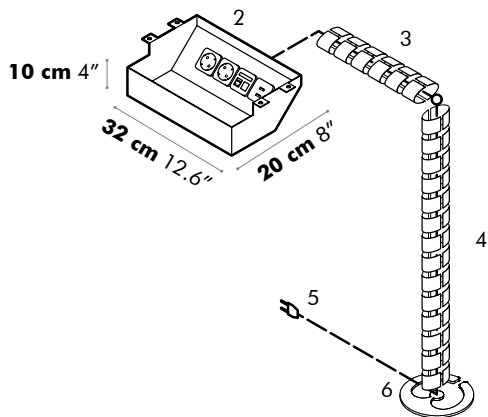

1	Cable entry cover (HPL only)	1x	(Pg. 5)
2	Electrification Unit	1x	
3	Horizontal Cable Manager	1x	
4	Vertical Cable Manager	1x	
5	Power Cable	1x	
6	Thermal fuse (US only)	1x	

## Cable Box Duo

for PicNic Round (includes all items as listed below)

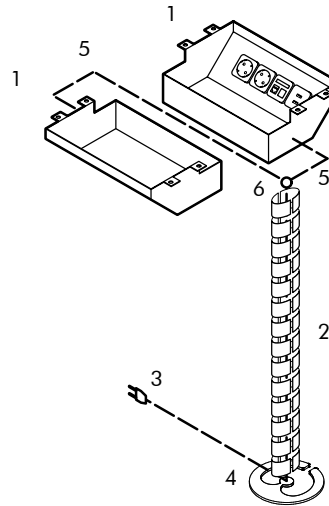

1	Electrification Unit	2x
2	Vertical Cable Manager	1x
3	Power Cable	1x
4	Thermal fuse (US only)	1x
5	Connection Cable	2x
6	Central Connection Block	2x

## Cable Box Quatro

for PicNic WorkBench (includes all items as listed below)

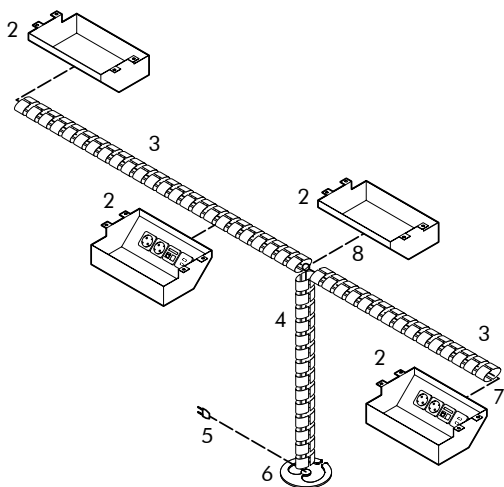

1	Cable entry cover (HPL only)	4x	(Pg. 5)
2	Electrification Unit	4x	
3	Horizontal Cable Manager	2x	
4	Vertical Cable Manager	1x	
5	Power Cable	1x	
6	Thermal fuse (US only)	1x	
7	Connection Cable	4x	
8	Central connection block	1x	

---

## Electrification Unit



Colour black  
Configuration see p. 13

---

## Horizontal Cable Management

Colour black  
Size 15 chains  
W 8 cm, L 91 cm, D 3,8 cm  
W 3", L 36", D 1.5"



---

## Power Cable

Length 3 m | 118.11"

---

## Vertical Cable Manager

Colour black  
Set for BuzziPicNic Low: 16 chains  
Set for BuzziPicNic High: 27 chains

- 1 set includes:  
vertical cable runs, base plate, table attachment, screw set
- Capacity up to  $\pm 40$  cables
- Material polypropylen (cable runs)  
painted steel (baseplate)
- 2 chamber system
- Cables using the easy zip principle



---

## Configuration of the Electrification Unit for PicNic

### Step 1: Select unit configuration

Note:

Cable Box Single = 1 x option A or 1 x option B

Cable Box Duo = 2 x option A or 2 x option B

Cable Box Quatro = 4 x option A or 4 x option B

Option A: 4 x Socket

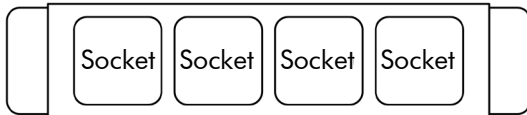



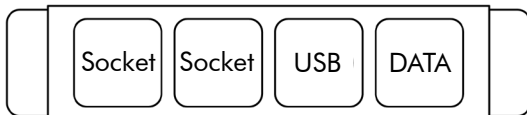

Option B: 2 x Socket + USB + Data



- 2 x socket
- 2 x data: RJ45 Cat 6 gender changer
- USB charging unit: 2 x female connector Type A  
current output 2 x 700mA  
5V DC

### Step 2: Select socket type

For more information on selecting the right socket for your region: visit [www.iec.ch/worldplugs](http://www.iec.ch/worldplugs)

- F  NL|DE|LUX
- E  BE|FR
- G  UK
- B  US

# Detailed Dimensions

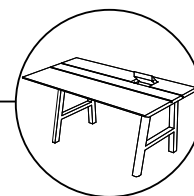

## BuzziPicNic Desk with Tabletop Wood

Low

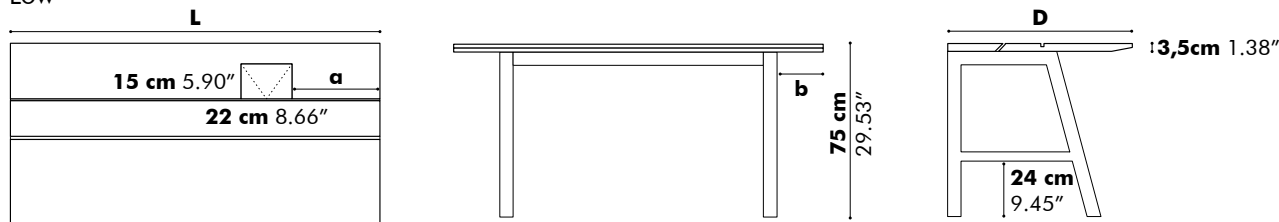

High

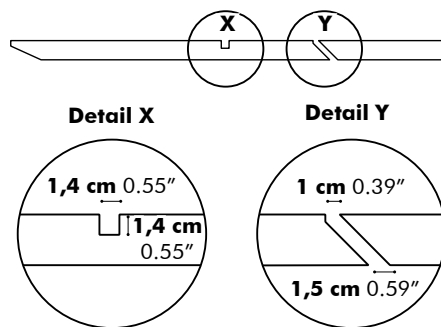
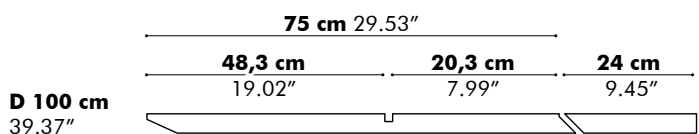
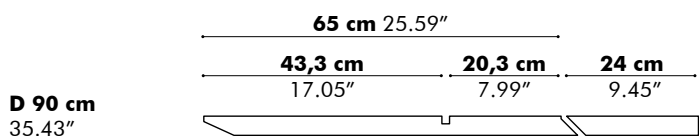
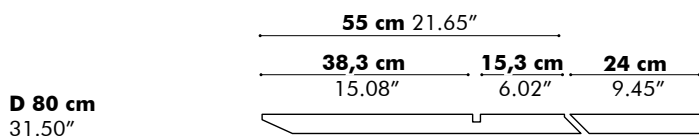
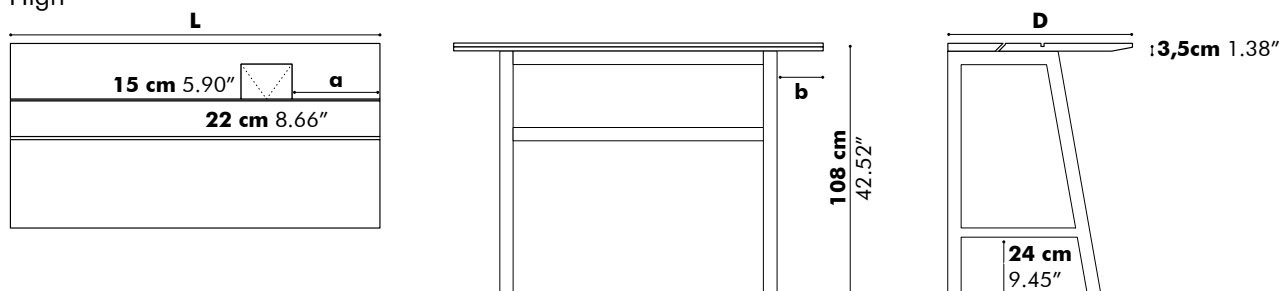

**D: 80 cm 31.50", 90 cm 35.43" or 100 cm 39.37"**

Value for a and b depends on the length of the PicNic Desk

L	120 cm 47.24"	140 cm 55.12"	160 cm 62.99"	180 cm 70.87"	200 cm 78.74"	220 cm 86.61"	240 cm 94.49"
a	28 cm 11.02"	33 cm 12.99"	38 cm 14.96"	38 cm 14.96"	38 cm 14.96"	38 cm 14.96"	43 cm 16.93"
b	10 cm 3.94"	15 cm 5.90"	20 cm 7.87"	20 cm 7.87"	20 cm 7.87"	20 cm 7.87"	25 cm 9.84"

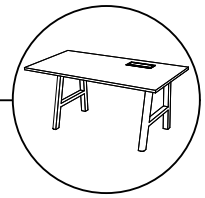

# BuzziPicNic Desk with Tabletop HPL

Low

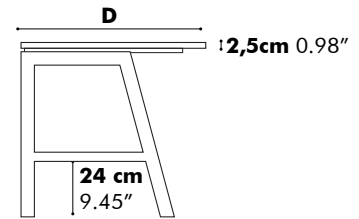
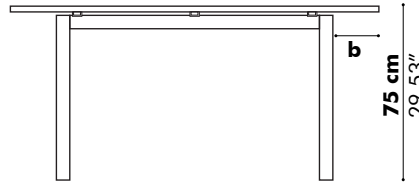
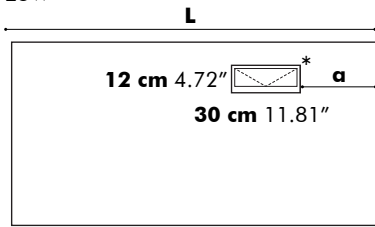

High

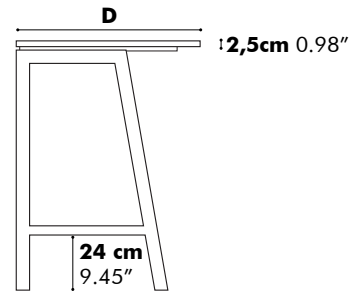
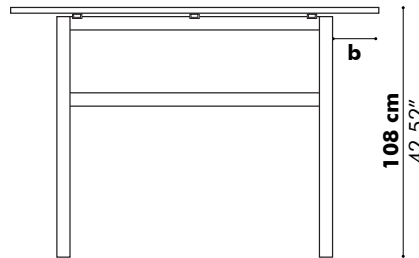
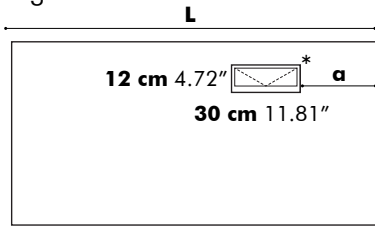

\* Optional

**D: 80 cm 31.50", 90 cm 35.43" or 100 cm 39.37"**

Value for a and b depends on the length of the PicNic Desk

	<b>120 cm 47.24"</b>	<b>140 cm 55.12"</b>	<b>160 cm 62.99"</b>	<b>180 cm 70.87"</b>	<b>200 cm 78.74"</b>	<b>220 cm 86.61"</b>	<b>240 cm 94.49"</b>
<b>a</b>	<b>28 cm 11.02"</b>	<b>33 cm 12.99"</b>	<b>38 cm 14.96"</b>	<b>38 cm 14.96"</b>	<b>38 cm 14.96"</b>	<b>38 cm 14.96"</b>	<b>43 cm 16.93"</b>
<b>b</b>	<b>10 cm 3.94"</b>	<b>15 cm 5.90"</b>	<b>20 cm 7.87"</b>	<b>20 cm 7.87"</b>	<b>20 cm 7.87"</b>	<b>20 cm 7.87"</b>	<b>25 cm 9.84"</b>

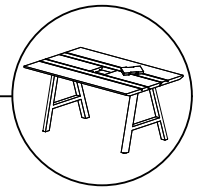

# BuzziPicNic Meet with Tabletop Wood

Low

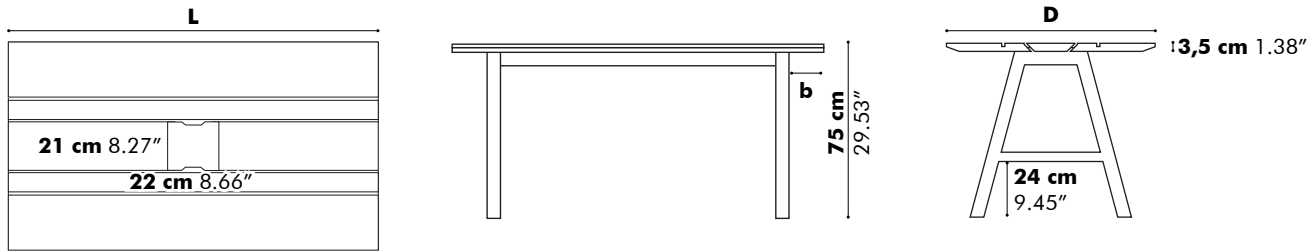

High

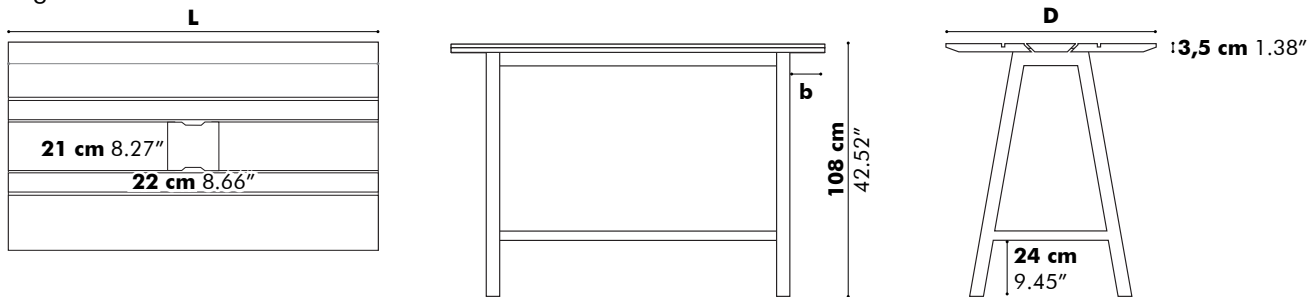

**D 80 cm\***  
31.50"

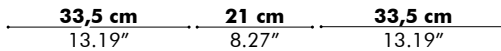
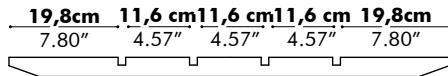

**D 90 cm**  
35.43"

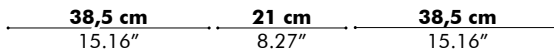
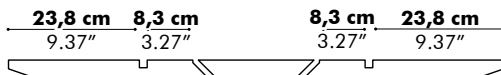

**D 100 cm**  
39.37"

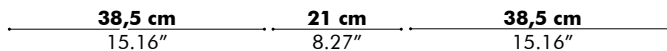
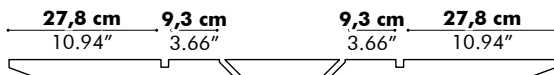

**D 120 cm**  
47.24"

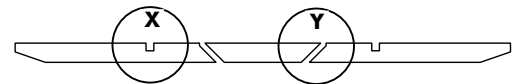

Detail X

Detail Y

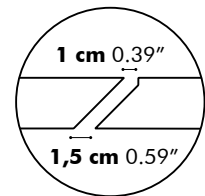
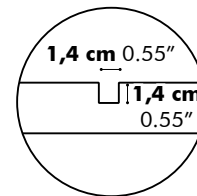

**D: 80 cm 31.50", 90 cm 35.43", 100 cm 39.37" or 120 cm 39.37"**

Value for a and b depends on the length of the PicNic Desk

<b>L</b>	<b>160 cm</b> 62.99"	<b>180 cm</b> 70.87"	<b>200 cm</b> 78.74"	<b>220 cm</b> 86.61"	<b>240 cm</b> 94.49"
<b>b</b>	<b>15 cm</b> 5.90"	<b>20 cm</b> 7.87"	<b>30 cm</b> 11.81"	<b>30 cm</b> 11.81"	<b>30 cm</b> 11.81"

\* This size is only available for BuzziPicNic Meet High



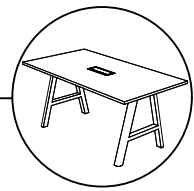

# BuzziPicNic Meet with Tabletop HPL

Low

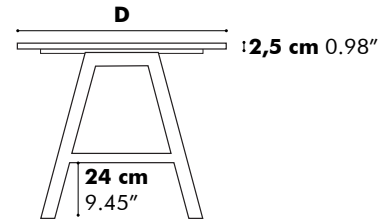
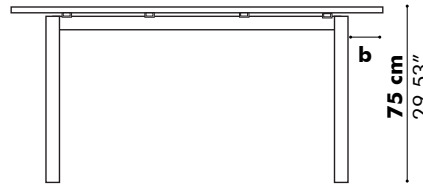
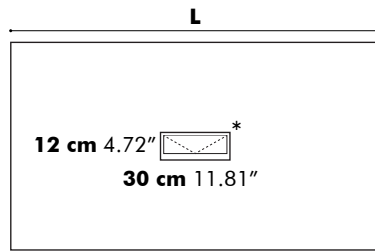

High

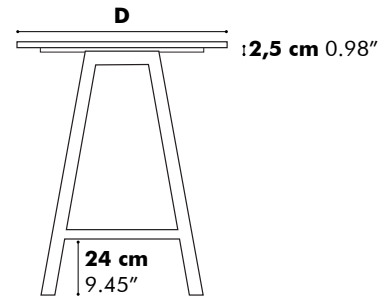
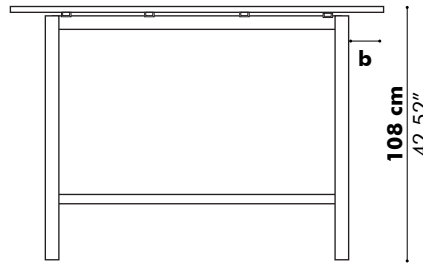
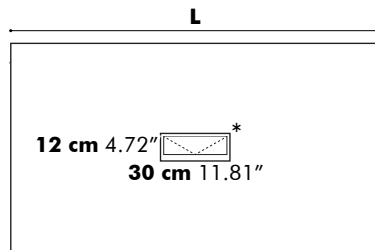

\* Optional

**D: 80 cm\*\* 31.50", 90 cm 35.43", 100 cm 39.37" or 120 cm 39.37"**

Value for a and b depends on the length of the PicNic Desk

<b>L</b>	<b>160 cm 62.99"</b>	<b>180 cm 70.87"</b>	<b>200 cm 78.74"</b>	<b>220 cm 86.61"</b>	<b>240 cm 94.49"</b>
<b>b</b>	<b>15 cm 5.90"</b>	<b>20 cm 7.87"</b>	<b>30 cm 11.81"</b>	<b>30 cm 11.81"</b>	<b>30 cm 11.81"</b>

\*\* This size is only available for BuzziPicNic Meet High

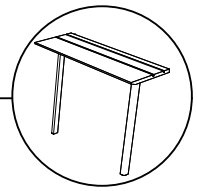

# BuzziPicNic Side with Tabletop Wood

Low

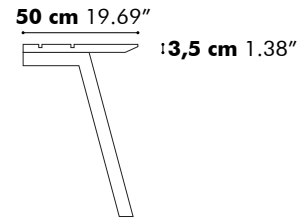
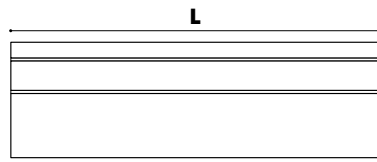

High

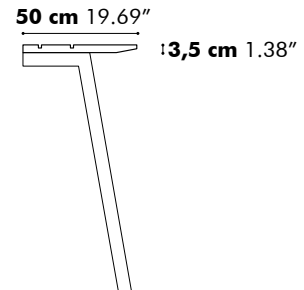
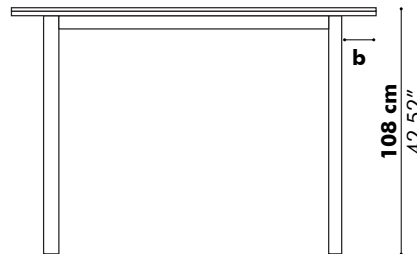

Detail X

D 50 cm  
19.69"

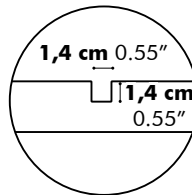
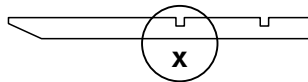

Value for b depends on the length of the PicNic Side

<b>L</b>	<b>160 cm</b> 62.99"	<b>180 cm</b> 70.87"	<b>200 cm</b> 78.74"	<b>220 cm</b> 86.61"	<b>240 cm</b> 94.49"
<b>b</b>	<b>15 cm</b> 5.90"	<b>20 cm</b> 7.87"	<b>30 cm</b> 11.81"	<b>30 cm</b> 11.81"	<b>30 cm</b> 11.81"

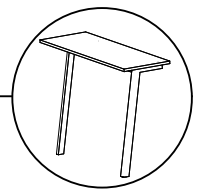

## BuzziPicNic Side with Tabletop HPL

Low

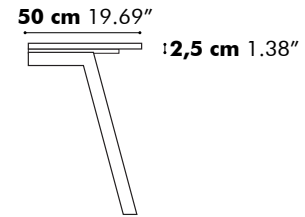
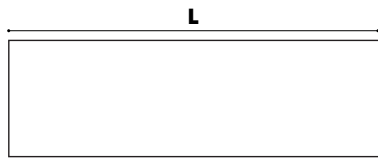

High

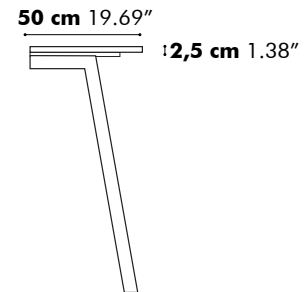
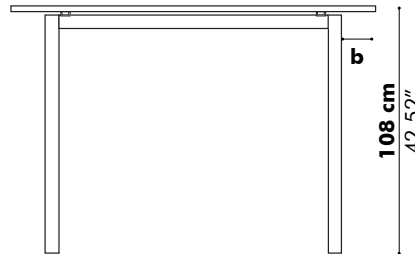
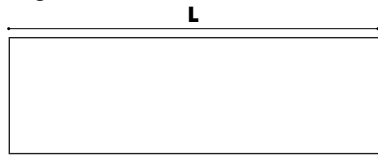

Value for b depends on the length of the PicNic Side

<b>L</b>	<b>160 cm</b> 62.99"	<b>180 cm</b> 70.87"	<b>200 cm</b> 78.74"	<b>220 cm</b> 86.61"	<b>240 cm</b> 94.49"
<b>b</b>	<b>15 cm</b> 5.90"	<b>20 cm</b> 7.87"	<b>30 cm</b> 11.81"	<b>30 cm</b> 11.81"	<b>30 cm</b> 11.81"

# BuzziPicNic WorkBench with Tabletop Wood

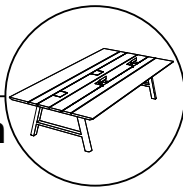

# BuzziPicNic WorkBench with Tabletop HPL

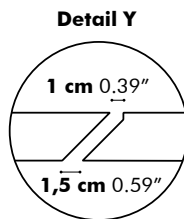
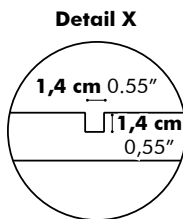
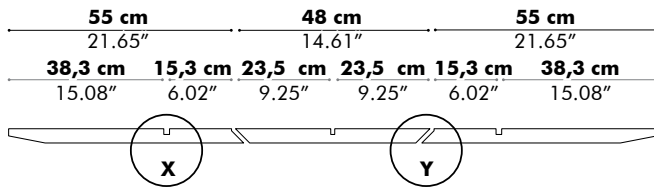
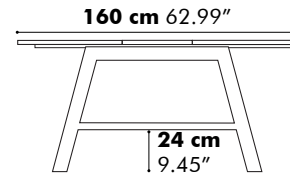
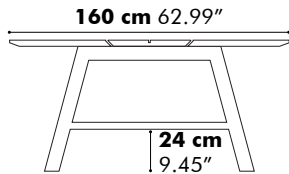
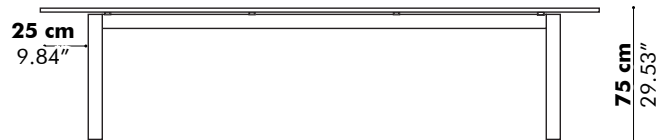
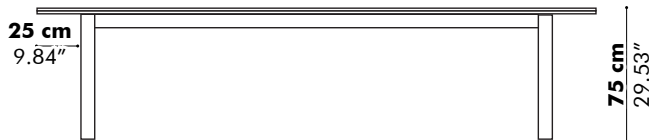
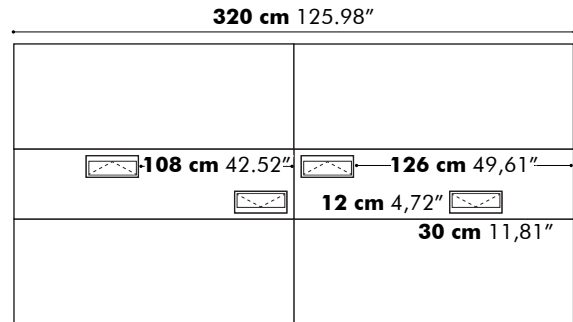
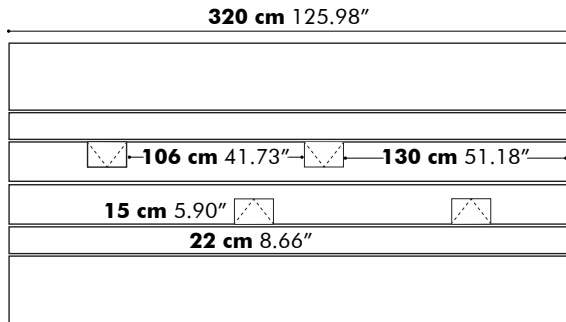
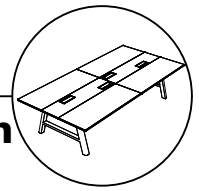

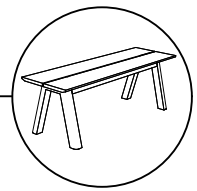

# BuzziPicNic Bench

**116 cm 45.66"**

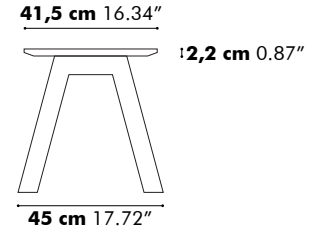
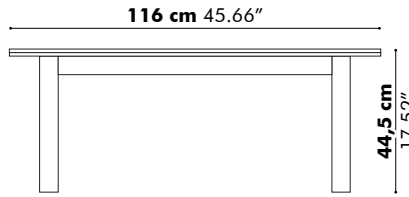
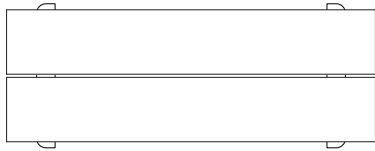

with cushion

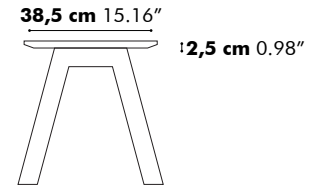
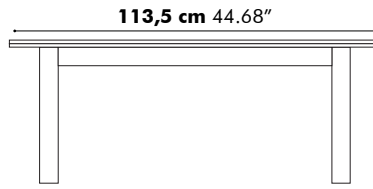

**136 cm 53.54"**

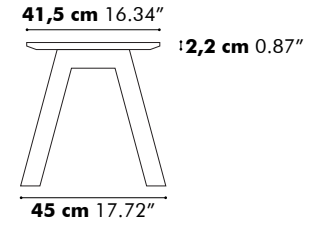
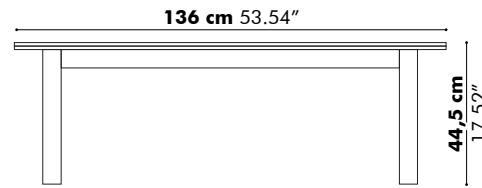
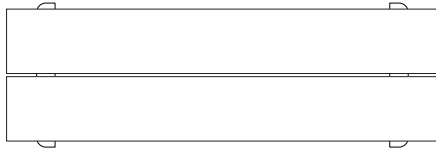

with cushion

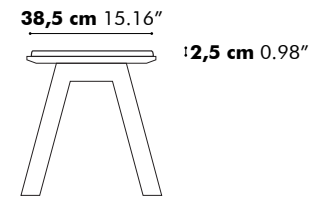
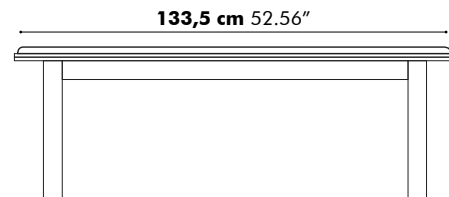

# BuzziPicNic Round

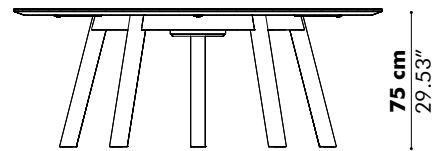
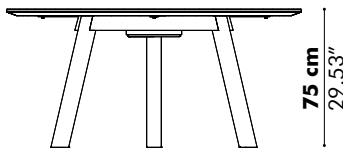
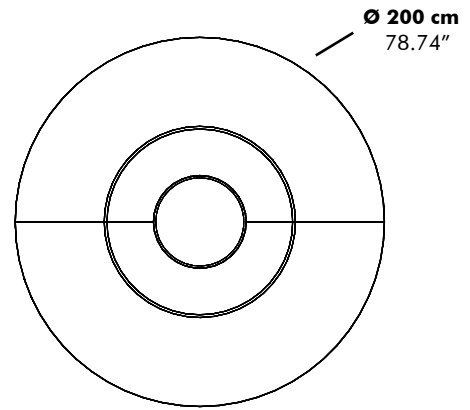
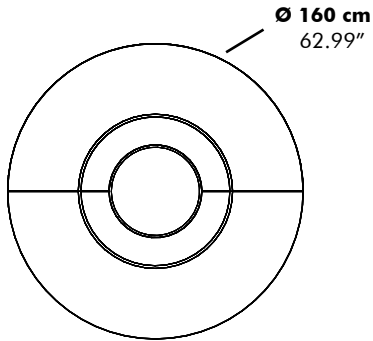
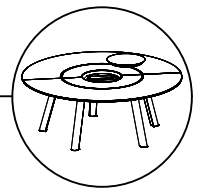

Detail X

Detail Y

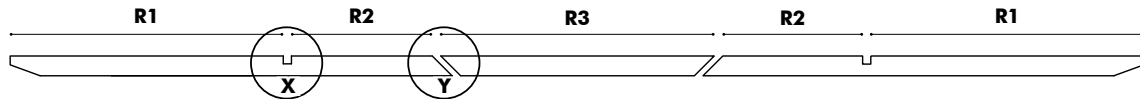
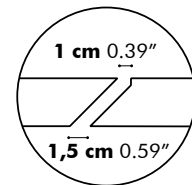
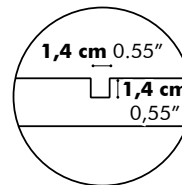

	R1	R2	R3
Ø 160 cm	38 cm 14.96"	15 cm 5.91"	48 cm 18.90"
Ø 200 cm	48 cm 18.90"	25 cm 9.84"	48 cm 18.90"

# Weights

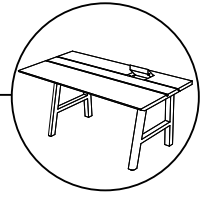

## PicNic Desk Low

Depth	Length	Weight
80 cm   31.50"	120 cm   47.24"	41,47 kg   91.43 lbs
	140 cm   55.12"	45,55 kg   100.42 lbs
	160 cm   62.99"	51,62 kg   113.80 lbs
	180 cm   70.87"	56,14 kg   123.77 lbs
	200 cm   78.74"	60,66 kg   133.73 lbs
	220 cm   86.61"	65,18 kg   143.70 lbs
	240 cm   94.49"	69,26 kg   152.69 lbs
90 cm   35.43"	120 cm   47.24"	45,98 kg   101.37 lbs
	140 cm   55.12"	50,52 kg   111.38 lbs
	160 cm   62.99"	57,33 kg   126.39 lbs
	180 cm   70.87"	62,31 kg   137.37 lbs
	200 cm   78.74"	67,28 kg   148.33 lbs
	220 cm   86.61"	72,26 kg   159.31 lbs
	240 cm   94.49"	76,79 kg   169.29 lbs
100 cm   39.37"	120 cm   47.24"	50,49 kg   111.31 lbs
	140 cm   55.12"	55,48 kg   122.31 lbs
	160 cm   62.99"	63,04 kg   138.98 lbs
	180 cm   70.87"	68,47 kg   150.95 lbs
	200 cm   78.74"	73,54 kg   162.13 lbs
	220 cm   86.61"	79,33 kg   174.89 lbs
	240 cm   94.49"	84,32 kg   185.89 lbs

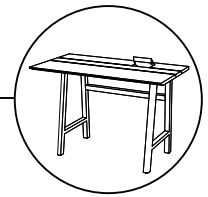

## PicNic Desk High

<b>Depth</b>	<b>Length</b>	<b>Weight</b>
80 cm   31.50"	120 cm   47.24"	45,69 kg   100.73 lbs
	140 cm   55.12"	49,79 kg   109.77 lbs
	160 cm   62.99"	55,89 kg   123.22 lbs
	180 cm   70.87"	60,44 kg   133.25 lbs
	200 cm   78.74"	64,99 kg   143.28 lbs
	220 cm   86.61"	69,54 kg   153.31 lbs
	240 cm   94.49"	73,63 kg   162.33 lbs
90 cm   35.43"	120 cm   47.24"	50,20 kg   110.67 lbs
	140 cm   55.12"	54,76 kg   120.73 lbs
	160 cm   62.99"	61,60 kg   135.80 lbs
	180 cm   70.87"	66,61 kg   146.85 lbs
	200 cm   78.74"	71,61 kg   157.87 lbs
	220 cm   86.61"	76,62 kg   168.92 lbs
	240 cm   94.49"	81,16 kg   178.93 lbs
100 cm   39.37"	120 cm   47.24"	54,71 kg   120.61 lbs
	140 cm   55.12"	59,69 kg   131.59 lbs
	160 cm   62.99"	67,31 kg   148.39 lbs
	180 cm   70.87"	72,77 kg   160.43 lbs
	200 cm   78.74"	78,23 kg   172.47 lbs
	220 cm   86.61"	83,69 kg   184.50 lbs
	240 cm   94.49"	88,69 kg   195.53 lbs





## PicNic Meet Low

<b>Depth</b>	<b>Length</b>	<b>Weight</b>
90 cm   35.43"	160 cm   62.99"	57,20 kg   126.10 lbs
	180 cm   70.87	61,73 kg   136.09 lbs
	200 cm   78.74"	65,82 kg   145.11 lbs
	220 cm   86.61"	70,80 kg   156.09 lbs
	240 cm   94.49"	75,76 kg   167.02 lbs
100 cm   39.37	160 cm   62.99"	62,66 kg   138.14 lbs
	180 cm   70.87	67,64 kg   149.12 lbs
	200 cm   78.74	72,19 kg   159.15 lbs
	220 cm   86.61"	77,62 kg   171.12 lbs
	240 cm   94.49"	83,04 kg   183.07 lbs
120 cm   47.24"	160 cm   62.99"	73,58 kg   162.22 lbs
	180 cm   70.87	79,47 kg   175.20 lbs
	200 cm   78.74"	84,93 kg   187.24 lbs
	220 cm   86.61"	91,27 kg   201.22 lbs
	240 cm   94.49"	97,60 kg   215.17 lbs



## PicNic Meet High

<b>Depth</b>	<b>Length</b>	<b>Weight</b>
80 cm   31.50"	160 cm   62.99"	53,77 kg   118.54 lbs
	180 cm   70.87"	57,99 kg   127.85 lbs
	200 cm   78.74"	61,63 kg   135.87 lbs
	220 cm   86.61"	66,45 kg   146.50 lbs
	240 cm   94.49"	71,26 kg   157.10 lbs
90 cm   35.43"	160 cm   62.99"	62,05 kg   136.80 lbs
	180 cm   70.87"	66,73 kg   147.11 lbs
	200 cm   78.74"	70,82 kg   156.13 lbs
	220 cm   86.61"	76,10 kg   167.77 lbs
	240 cm   94.49"	81,36 kg   179.37 lbs
100 cm   39.37"	160 cm   62.99"	67,51 kg   148.83 lbs
	180 cm   70.87"	72,64 kg   160.14 lbs
	200 cm   78.74"	77,19 kg   170.17 lbs
	220 cm   86.61"	82,92 kg   182.81 lbs
	240 cm   94.49"	88,64 kg   195.42 lbs
120 cm   47.24"	160 cm   62.99"	78,43 kg   172.91 lbs
	180 cm   70.87"	84,47 kg   186.22 lbs
	200 cm   78.74"	89,93 kg   198.26 lbs
	220 cm   86.61"	96,57 kg   212.90 lbs
	240 cm   94.49"	103,20 kg   227.52 lbs

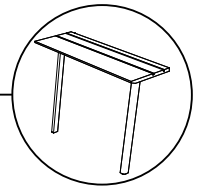

## PicNic Side Low

Depth	Length	Weight
50 cm   19.69"	160 cm   62.99"	30,11 kg   66.38 lbs
	180 cm   70.87"	33,27 kg   73.35 lbs
	200 cm   78.74"	35,54 kg   78.35 lbs
	220 cm   86.61"	38,69 kg   85.30 lbs
	240 cm   94.49"	41,84 kg   92.24 lbs

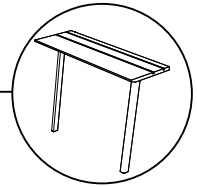

## PicNic Side High

Depth	Length	Weight
50 cm   19.69"	160 cm   62.99"	31,55 kg   69.56 lbs
	180 cm   70.87"	34,71 kg   76.52 lbs
	200 cm   78.74"	36,98 kg   81.53 lbs
	220 cm   86.61"	40,13 kg   88.47 lbs
	240 cm   94.49"	43,28 kg   95.42 lbs

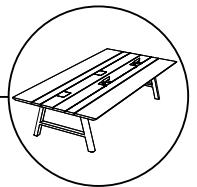

## PicNic Workbench

Depth	Length	Weight
160 cm   62.99"	320 cm   125.98"	176,31 kg   388.70 lbs



## PicNic Bench

Depth	Length	Weight
41,5 cm   16.34"	136 cm   53.54"	17,60 kg   38.80 lbs

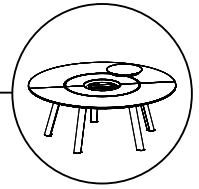

---

## PicNic Round

Depth	Length	Weight
160 cm   62.99"	160 cm   62.99"	70 kg   154.32 lbs
200 cm   78.74"	200 cm   78.74"	100 kg   220.46 lbs

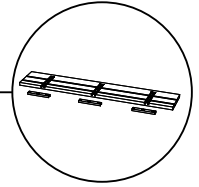

---

## PicNic Desk Connect

Length	Weight
120 cm   47.24"	10,33 kg   22.77 lbs
140 cm   55.12"	11,81 kg   26.04 lbs
160 cm   62.99"	14,02 kg   30.91 lbs
180 cm   70.87"	15,50 kg   34.17 lbs
200 cm   78.74"	16,98 kg   37.43 lbs
220 cm   86.61"	18,46 kg   40.70 lbs
240 cm   94.49"	19,94 kg   43.96 lbs

# Wood Disclaimer

## Every tree is unique

Wood is a natural product and has variations. While we do our utmost to provide you with the finest and almost identical wood products, it is almost impossible to find two trees that are alike.

Following from the organic nature of wood, it develops its own character throughout the growth process, which is reflected in color, knots and structure. Every tree is unique, and therefore slight variations will appear in every piece of furniture.

## The role of humidity

Over time, all wood products will absorb and release moisture. Consequently, humidity plays a crucial role in the right treatment of your wood products. Under dry conditions, low humidity levels, the wood shrinks and small cracks and splits can occur. On the contrary, high humidity levels will make the wood expand and restore cracks caused by dry conditions.

Please be aware, even weather changes can potentially prompt changes in wood, especially during months of high humidity levels and opposite during winter times when additional indoor heating is used, thereby making the air dryer.

Therefore, we advise to ensure a constant level of humidity through the use of humidifiers or water evaporators. Ideally, the indoor humidity levels must be between 50% and 60%.

## Take good care of your wood products

To ensure maximum lifetime of wood products, good maintenance is key. Therefore, we would like to highlight a few measures you can take to avoid any unnecessary changes and/or damages to your products.

By placing your wood products in direct sunlight, color differences may occur over time. The same holds true for tableware that is placed on a table. Avoid placing any hot objects directly on the wood as this may cause rings to form.

As stated previously, wood is sensitive to moisture. Therefore, wipe off any excessive liquids immediately. Clean stain and veneer wood with a damp cloth, and if necessary, use an appropriate cleaning agent. Don't use any shaving or polishes that contain silicone as this may prompt permanent stains.

Remember, all types of wood are organic materials and the creation of small cracks and splints are natural consequences. Therefore, complaints that can be derived from this, will not be accepted