



Product Specification Sheet

BuzziPebl Light 220-240V

— By BuzziSpace Studio

Accent Your Space

Inspired by the smooth shape of a pebble, BuzziPebl Light absorbs sound waves and, if desired, emits light. The acoustic lighting solution features an LED light strip to provide accent lighting to your desired space while creating a luminous environment, whether it be an office, lounge, reception, bar, or restaurant.

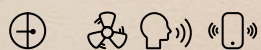

The Family

Lighting Units

LED Line Flex 200

LED Line Flex 300

**BuzziPebl Light One
Medium**

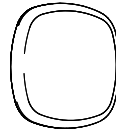

**BuzziPebl Light One
Large**

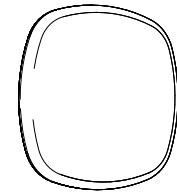

Models

**BuzziPebl Light Two
Medium**

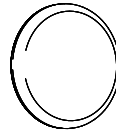

**BuzziPebl Light Two
Large**

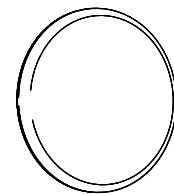

Required order information

1. Model
2. Size
3. Fabric (CAT -> Collection -> Color)
4. Lighting Options (Input Voltage, Color Temperature)

Lighting Data

Lighting Unit

Led Line Flex



A flexible LED Line is included for a decorative, indirect light at the back of the upholstered panel.

The flexible LED Line is available in two sizes: LED Line Flex 200 and LED Line flex 300.

Lighting Options

Models: One | Two Medium

Lighting Options

Characteristics

Mounting

Voltage Input

Color Temperature

Technical

Options

220-240V

2700K

4000K

Power consumption: 30W
Light output: 1700 Lm
Efficacy: 57 Lm/W
CRI: > 85

Wall Mounted

Models: One | Two Large

Options

Characteristics

Mounting

Voltage Input

Color Temperature

Technical

Options

220-240V

2700K

4000K

Power consumption: 45W
Light output: 2500 Lm
Efficacy: 56 Lm/W
CRI: > 85

Wall Mounted

Product Data

Fixing System

Wall Mounted

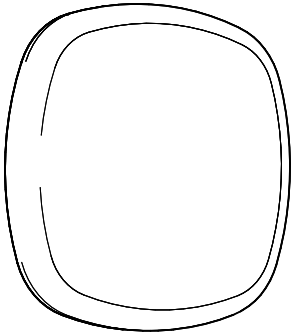

According to the specifications of the wall, it's recommended to use the appropriate plugs.

Acoustic Panel

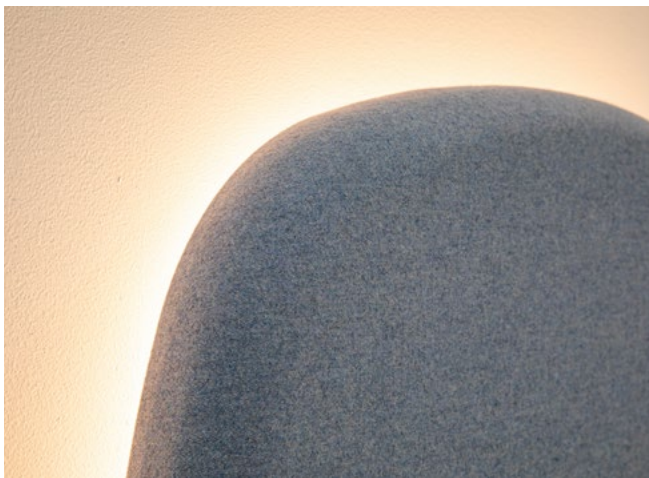

Acoustic foam element with MDF backing, upholstered in a chosen fabric.



Absorption



Low tone



Mid tone



High tone

Acoustics

BuzziPebl Light Equivalent sound absorption area in m² per object

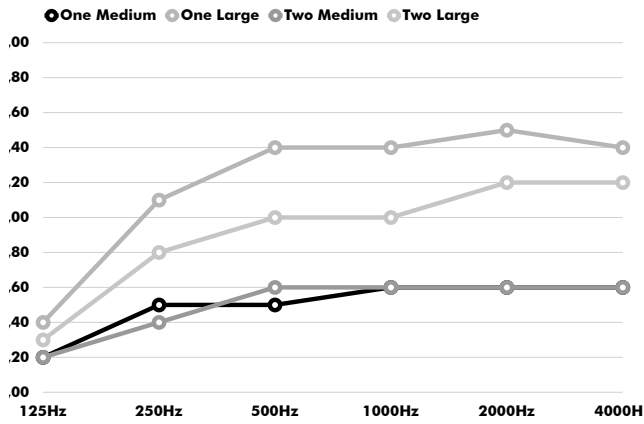

Hz	One Medium Aeq/m ²	One Large Aeq/m ²	Two Medium Aeq/m ²	Two Large Aeq/m ²
125	0.20	0.40	0.20	0.30
250	0.50	1.10	0.40	0.80
500	0.50	1.40	0.60	1.00
1000	0.60	1.40	0.60	1.00
2000	0.60	1.50	0.60	1.20
4000	0.60	1.40	0.60	1.20

Dimensions BuzziPebl Light

BuzziPebl Light One Medium

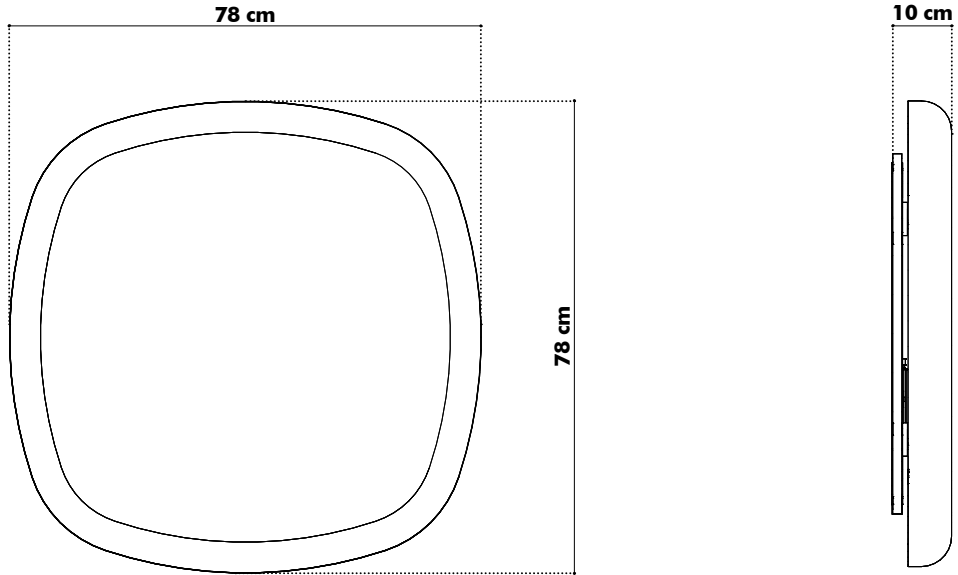

BuzziPebl Light One Large

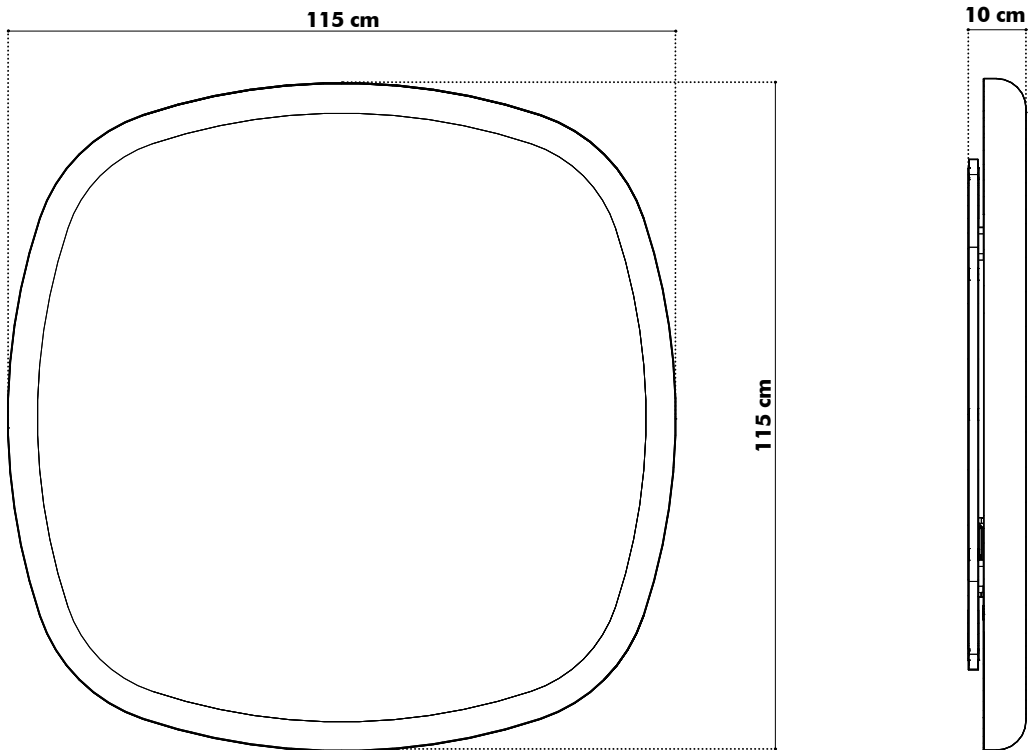

BuzziPebl Light Two Medium

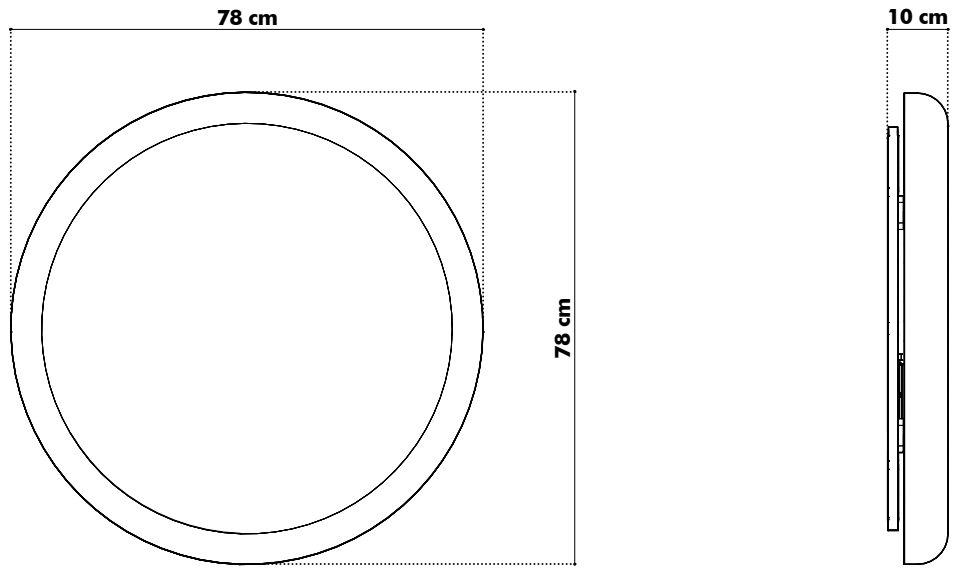

BuzziPebl Light Two Large

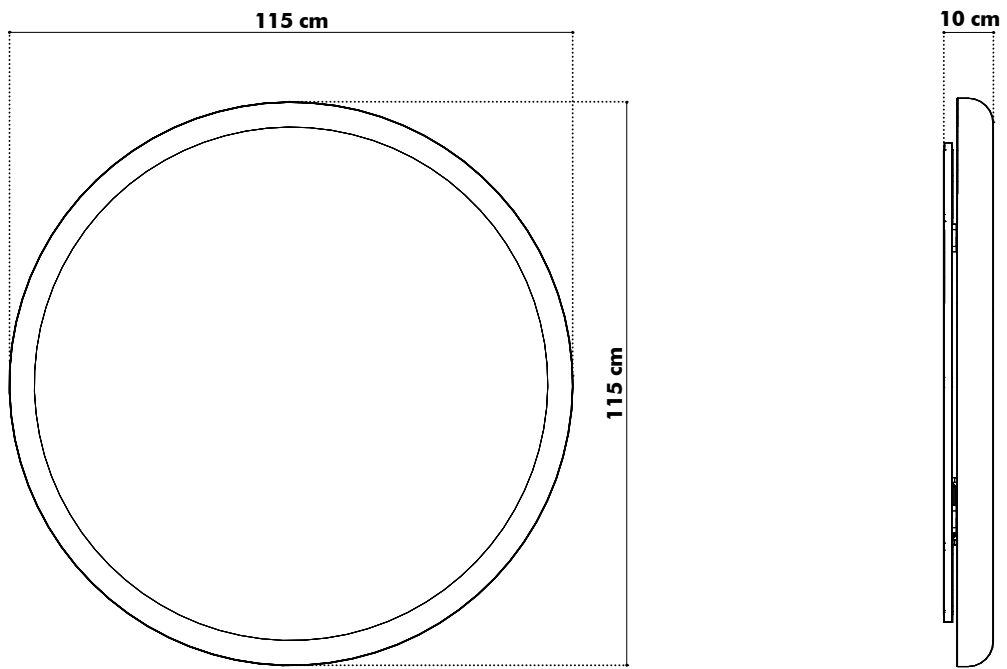

Weights

BuzziPebl Light One Medium

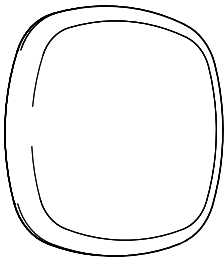

8,7 kg

BuzziPebl Light One Large

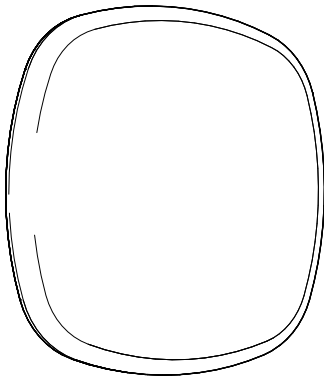

18,5 kg

BuzziPebl Light Two Medium

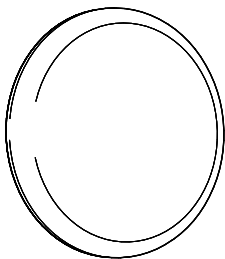

8,5 kg

BuzziPebl Light Two Large

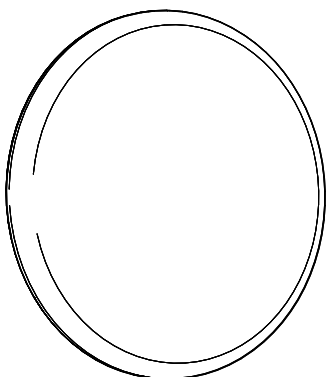

17,5 kg

Fabrics

Fabric (45 colors)

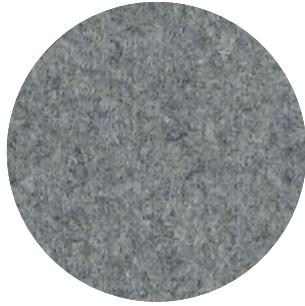

Category A

Composition 70% Recycled Wool, 25% Recycled Polyacryl,
5% Recycled Other Fabrics

Weight 405 g/m² | 11.94 oz/yd²

Abrasion resistance 40.000 Martindale, 50,000 Wyzenbeek

Flammability EU: EN 1021.1/2006 | BS EN 1021.1/2006 (cigarette).
EN 1021.2/2006 | BS EN 1021.2/2006 (match)
USA: CAL TB 117 | ASTM E84 CLASS A

Fastness to light EU: 4 | USA 4

Fastness to rubbing EU: Wet 3-4 | Dry 4-5

Fastness to crocking USA: Wet 5 | Dry 5



Tonus 4 (47 colors)

kvadrat



Category D

Composition 90% new wool, 10% Helanca

Weight 665 g/lin.m

Abrasion resistance 100.000 Martindale rubs, EN ISO 12947

Flammability EN 1021-1/2 | BS 5852 part 1 | DIN 4102 B2
Önorm B1/Q1 | NF D 60 013 | UNI 9175 11M
US Cal. Bull. 117-2013 | NFPA 260 | IMO A.652 (16)

Fastness to light Note 5-7, ISO 105-B02

Fastness to rubbing (ISO) dry 3-5, wet 3-5

Pilling Note 3, EN ISO 12945

