



## Product Specification Sheet

### **BuzziHat EU**

— By Alain Gilles

#### **Say goodbye to noisy environments with BuzziHat**

A decorative and highly recognizable hat-shaped pendant light with excellent sound absorption capabilities.

Its unique design, combining an upholstered part with a metal shade is bound to steal the attention in any space.

The upholstered foam body is available in a wide palette of color and fabric combinations, while the metal shade and ring come in 4 finishes (black, white, beige red and gold). Mix colors of your choosing and match the fabric of BuzziHat with the color of your furniture to create an impeccable setting. BuzziHat is available in different sizes to fit different sonic environments which makes it the ultimate acoustic lighting for any office, lobby or restaurant that needs acoustic absorption treatment combined with high-quality lighting.



# The Family

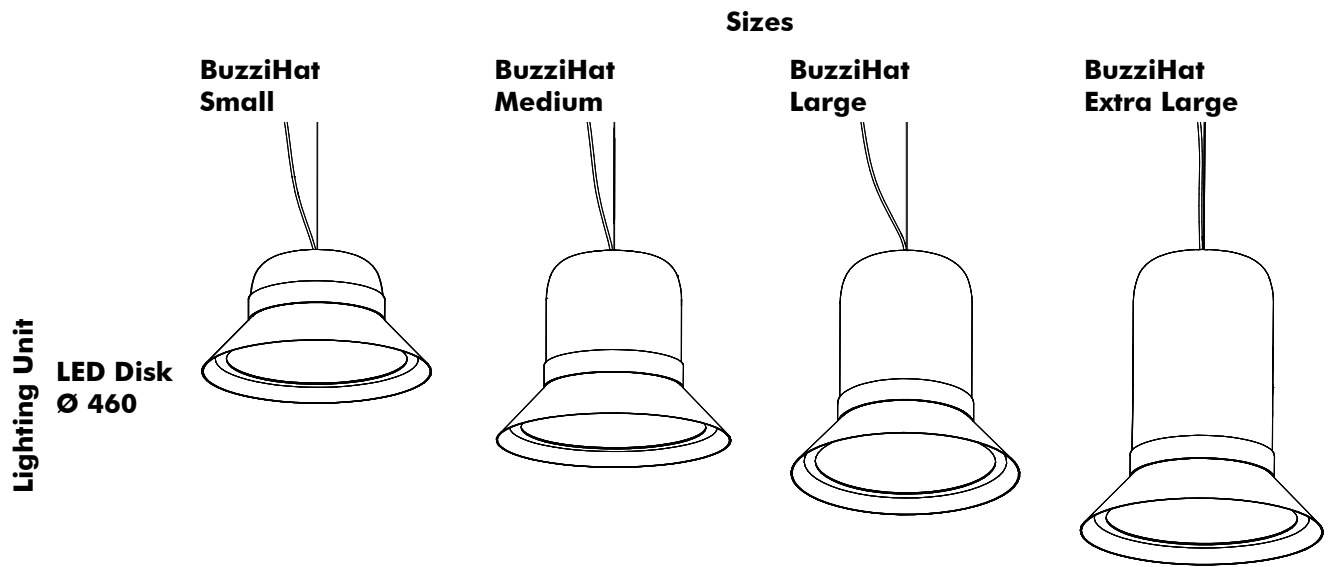

Required order information

1. Size
2. Fabric (CAT -> Collection -> Color)
3. Color Metal Shade
4. Color Decorative Ring
5. Mounting Option

# Lighting Data

---

## Lighting Unit



The PMMA diffuser ensures an optimal light spread and efficiency. It creates a very diffuse light surface without any dottiness.

On Request: UGR 19

To achieve a UGR 19, the product is fitted with a Prismatic diffuser instead of a milky diffuser. LED dots will be visible.

**BuzziHat Small**

Lighting Unit	Voltage	Wattage	Light Output Luminaire	Efficacy (Lm/W)	CRI	Dimming	Color Temperature	UGR	Standard (stock) On request (>LT)	Color Power Cable	Color Ceiling Canopy	Color Metal Shade and Ring	Fabric Collection	Fabric Color	Mounting Option
LED Disk Ø460	230V	19W	2000 Lm	105	80	1-10V	3000K	20	Standard	Transparent	White	Black, White, Beige Red, Gold	Use color codes below	Use color codes below	1 cable of 2 m Alu or Black 1 cables of 5 m Alu or Black
LED Disk Ø460	230V	19W	2000 Lm	105	80	1-10V	3000K	19	On Request	Black					

**BuzziHat Medium**

Lighting Unit	Voltage	Wattage	Light Output Luminaire	Efficacy (Lm/W)	CRI	Dimming	Color Temperature	UGR	Standard (stock) On request (>LT)	Color Power Cable	Color Ceiling Canopy	Color Metal Shade and Ring	Fabric Collection	Fabric Color	Mounting Option
LED Disk Ø460	230V	19W	2000 Lm	105	80	1-10V	3000K	20	Standard	Transparent	White	Black, White, Beige Red, Gold	Use color codes below	Use color codes below	1 cable of 2 m Alu or Black 1 cables of 5 m Alu or Black
LED Disk Ø460	230V	19W	2000 Lm	105	80	1-10V	3000K	19	On Request	Black					

**BuzziHat Large**

Lighting Unit	Voltage	Wattage	Light Output Luminaire	Efficacy (Lm/W)	CRI	Dimming	Color Temperature	UGR	Standard (stock) On request (>LT)	Color Power Cable	Color Ceiling Canopy	Color Metal Shade and Ring	Fabric Collection	Fabric Color	Mounting Option
LED Disk Ø460	230V	19W	2000 Lm	105	80	1-10V	3000K	20	Standard	Transparent	White	Black, White, Beige Red, Gold	Use color codes below	Use color codes below	1 cable of 2 m Alu or Black 1 cables of 5 m Alu or Black
LED Disk Ø460	230V	19W	2000 Lm	105	80	1-10V	3000K	19	On Request	Black					

**BuzziHat Extra Large**

Lighting Unit	Voltage	Wattage	Light Output Luminaire	Efficacy (Lm/W)	CRI	Dimming	Color Temperature	UGR	Standard (stock) On request (>LT)	Color Power Cable	Color Ceiling Canopy	Color Metal Shade and Ring	Fabric Collection	Fabric Color	Mounting Option
LED Disk Ø460	230V	19W	2000 Lm	105	80	1-10V	3000K	20	Standard	Transparent	White	Black, White, Beige Red, Gold	Use color codes below	Use color codes below	1 cable of 2 m Alu or Black 1 cables of 5 m Alu or Black
LED Disk Ø460	230V	19W	2000 Lm	105	80	1-10V	3000K	19	On Request	Black					

CE CB

---

# Photometric Data

## BuzziHat LED Disk Ø 460

BuzziHat White Shade Cartesian Diagram

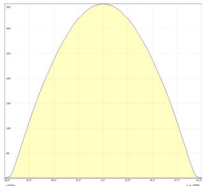

BuzziHat White Shade Polar curve

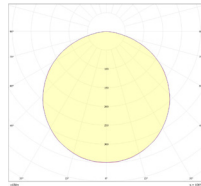

BuzziHat Black Shade Cartesian diagram

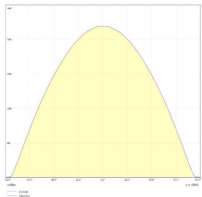

BuzziHat Black Shade Polar curve

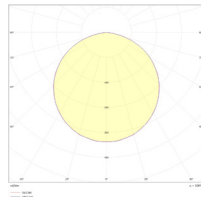

---

## Tips and Tricks - Light Options

To enlight your workplace with optimal lux levels take following measurements into account:

Office,  
Meeting room

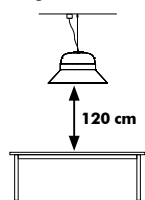

500 Lux

Reception desk, lounge, classroom

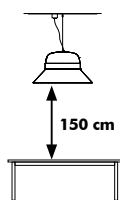

300 Lux

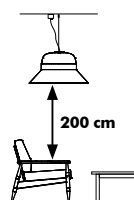

200 Lux

Entrance Hall

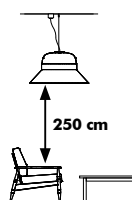

100 Lux

To ensure a continuous light spread into account take following distances inbetween the BuzziHats

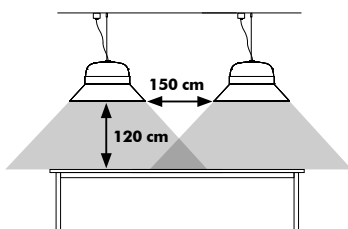

500 Lux

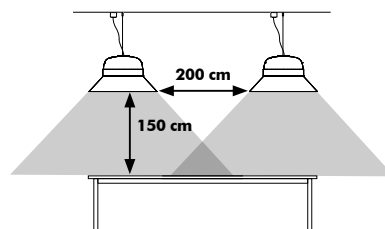

300 Lux

According to EN12464

# Product Data

---

## Fixing System

### Fixing System BuzziHat

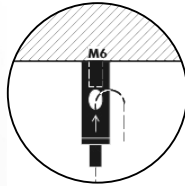

BuzziHat is suspended on 1 cable of 2 or 5 m black or alu colored cables, with fixing system screw.

▲ If installing on suspended ceiling, verify load capacity prior to installation.

---

## Acoustic Body



The acoustic body is upholstered in a chosen fabric.

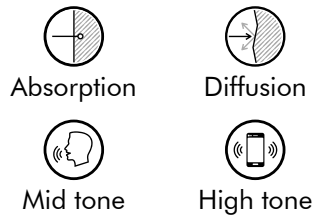

## Metal Shade and Ring



The powder coated metal shade and decorative ring are available in 4 colors: Black (RAL 9005), White (RAL 9010), Beige Red (RAL 3012) or Gold

---

## Mix and Match



Customize your BuzziHat by mixing and matching the color of the ring, the shade and the upholstery fabric.

---



---

# Acoustics

## BuzziHat

Equivalent sound absorption area in m<sup>2</sup> per object

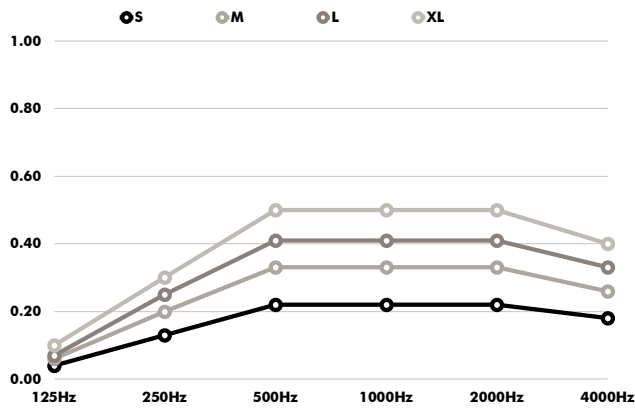

Hz	S Aeq/m <sup>2</sup>	M Aeq/m <sup>2</sup>	L Aeq/m <sup>2</sup>	XL Aeq/m <sup>2</sup>
125	0.04	0.06	0.07	0.10
250	0.13	0.20	0.25	0.30
500	0.22	0.33	0.41	0.50
1000	0.22	0.33	0.41	0.50
2000	0.22	0.33	0.41	0.50
4000	0.18	0.26	0.33	0.40

---

# Dimensions

## BuzziHat S

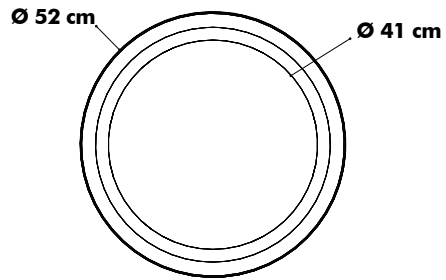
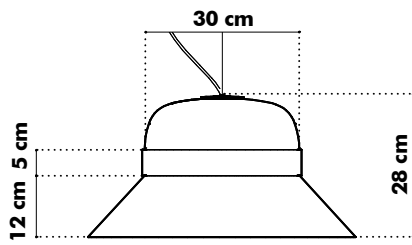

## BuzziHat M

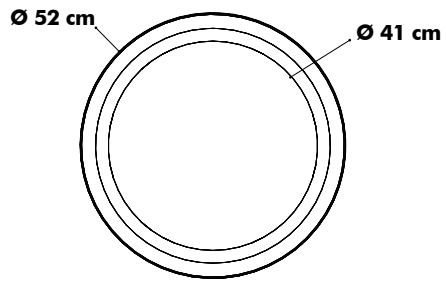
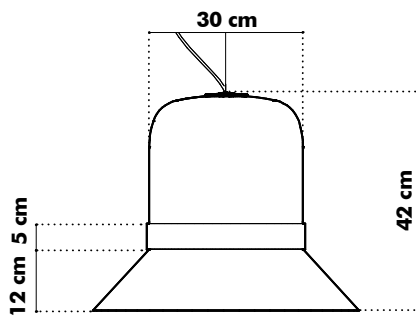

## BuzziHat L

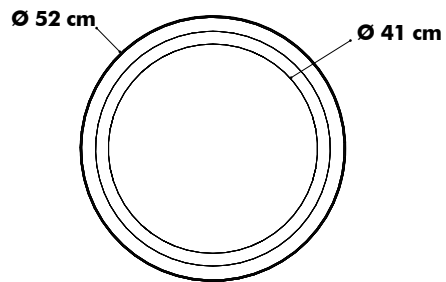
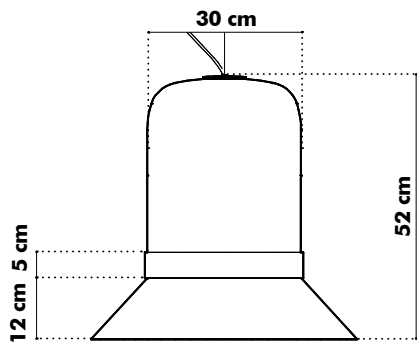

## BuzziHat XL

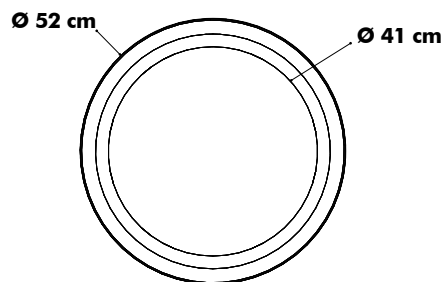
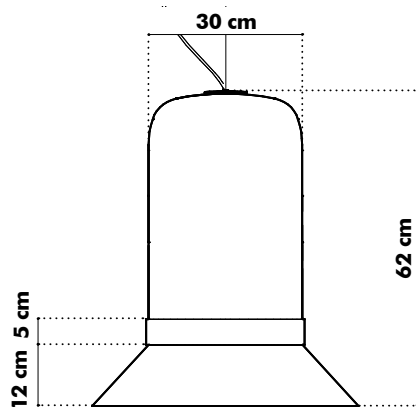



# Suspension Set

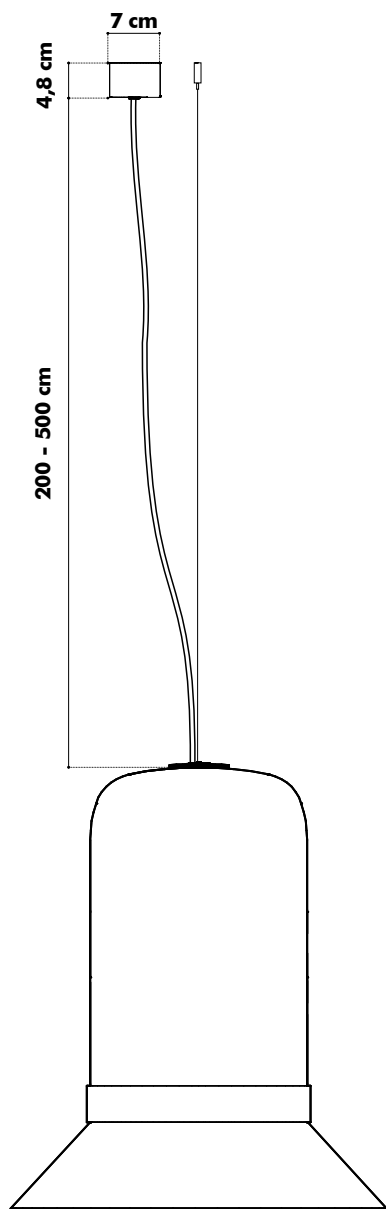

---

## Weights

### BuzziHat Small

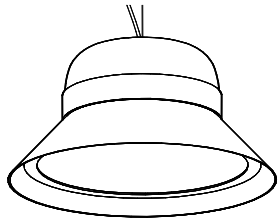

 6,5 kg

### BuzziHat Medium

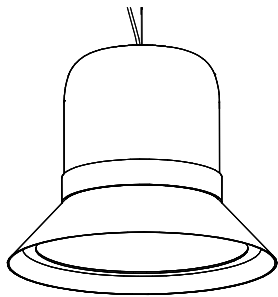

 7 kg

### BuzziHat Large

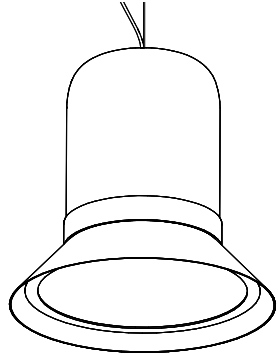

 7,5 kg

### BuzziHat Extra Large

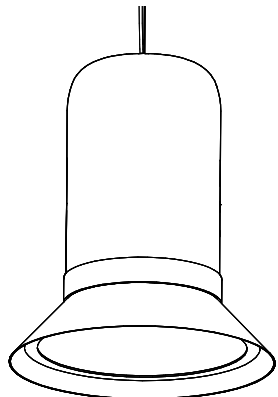

 8 kg

# Fabrics

## Fabric (45 colors)

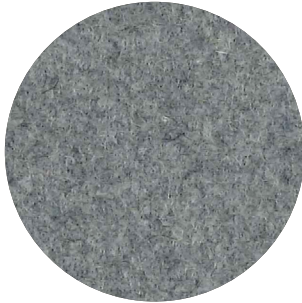

**Category A**

**Composition** 70% Recycled Wool, 25% Recycled Polyacryl,  
5% Recycled Other Fabrics

**Weight** 405 g/m<sup>2</sup> | 11.94 oz/yd<sup>2</sup>

**Abrasion resistance** 40.000 Martindale, 50,000 Wyzenbeek

**Flammability** EU: EN 1021.1/2006 | BS EN 1021.1/2006 (cigarette).  
EN 1021.2/2006 | BS EN 1021.2/2006 (match)  
USA: CAL TB 117 | ASTM E84 CLASS A

**Fastness to light** EU: 4 | USA 4

**Fastness to rubbing** EU: Wet 3-4 | Dry 4-5

**Fastness to crocking** USA: Wet 5 | Dry 5



## Trevira CS+ | CS (47 colors)

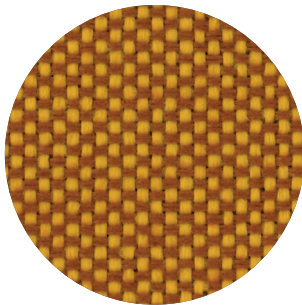

**Category A**

**Weight** 420 g/m<sup>2</sup> | 12.39 oz/yd<sup>2</sup>

**Composition** 100% Polyester, Trevira CS

**Abrasion resistance** 100.000 Martindale, 90,000 Wyzenbeek

**Flammability** BS 5852 part II: CRIB 5 | BS 7176 Medium Hazard  
USA: CAL TB 117 | M1 | B1 | EN 1021/1-2 | C1 |  
IMO Res. A652 (16)

**Fastness to light** EU: 6 | USA 5

**Fastness to rubbing** EU: Wet 4-5 | Dry 4-5

**Fastness to crocking** USA: Wet 5 | Dry 5



## Revive 1 (25 colors)

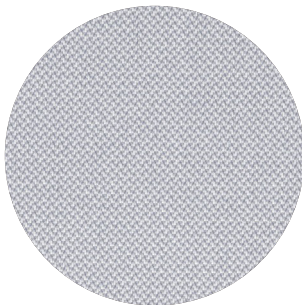

**Category A**

**Composition** 100% recycled polyester FR

**Weight** 430 g/lin.m

**Abrasion resistance** 60.000 Martindale rubs, EN ISO 12947

**Flammability** EN 1021-1/2 | DIN 4102 B1 | Önorm B1/Q1  
UNI 9175 1IM | US Cal. Tech. Bull. 117  
IMO A.652 (16)

**Fastness to light** Note 5-7, ISO 105-B02

**Fastness to rubbing** (ISO) dry 5, wet 4-5

**Pilling** Note 4-5, EN ISO 12945



kvadrat

## Velvet (12 colors)

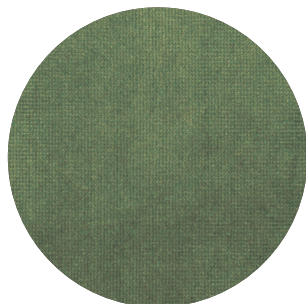

**Category** B  
**Composition** 100% PES  
**Weight** 375 g/m<sup>2</sup> | 11.06 oz/yd<sup>2</sup>  
**Abrasion resistance** > 100.000 Martindale  
**Fastness to light** EU: 4-5  
**Fastness to rubbing** EU: Wet 4 | Dry 4-5  
**Pilling** EU: 4-5

## Clara 2 (24 colors)

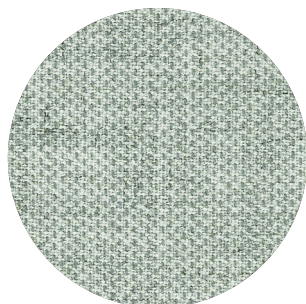

**Category** B  
**Composition** 92% new wool, 8% nylon  
**Weight** 400 g/lin.m  
**Abrasion resistance** 80.000 Martindale rubs, EN ISO 12947  
**Flammability** EN 1021-1/2 | BS 5852, ignition source 2-3 | DIN 4102 B2  
NF D 60 013 | UNI 9175 1IM | US Cal. Tech. Bull. 117, Sec. E  
NFPA 260 | IMO A.652(16)  
**Fastness to light** Note 5-7, ISO 105-B02  
**Fastness to rubbing** (ISO) dry 4-5, wet 4  
**Pilling** Note 4, EN ISO 12945



kvadrat

## Remix 3 (73 colors)



**Category** B  
**Composition** 90% new wool, 10% nylon  
**Weight** 415 g/lin.m  
**Abrasion resistance** 100.000 Martindale rubs, EN ISO 12947  
**Flammability** EN 1021-1/2 | BS 5852 part 1  
Önorm B1/Q1 | NF D 60 013 | UNI 9175, 1IM  
AS/NZS 1530.3 | Cal. Tech. Bull. 117-2013  
NFPA 260 | IMO FTP Code 2010:Part 8  
**Fastness to light** Note 5-7, ISO 105-B02  
**Fastness to rubbing** (ISO) dry 4-5, wet 4  
**Pilling** Note 4, EN ISO 12945



kvadrat

## Hero 2 (33 colors)

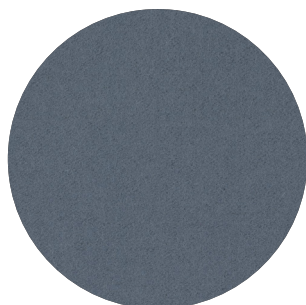

**Category** C  
**Composition** 97% new wool, 3% nylon  
**Weight** 580 g/lin.m  
**Abrasion resistance** 45.000 Martindale rubs, EN ISO 12947  
**Flammability** EN 1021-1/2 | DIN 4102 B2 | NF D 60 013  
UNI 9175 1IM | US Cal. Bull. 117-2013 | NFPA 260  
IMO A.652 (16)  
**Fastness to light** Note 5-6, ISO 105-B02  
**Fastness to rubbing** (ISO) dry 4-5, wet 4-5  
**Pilling** Note 3-4, EN ISO 12945



kvadrat

## Tonus 4 (47 colors)

kvadrat



**Category** D

**Composition** 90% new wool, 10% Helanca

**Weight** 665 g/lin.m

**Abrasion resistance** 100.000 Martindale rubs, EN ISO 12947

**Flammability** EN 1021-1/2 | BS 5852 part 1 | DIN 4102 B2

Önorm B1/Q1 | NF D 60 013 | UNI 9175 11M

US Cal. Bull. 117-2013 | NFPA 260 | IMO A.652 (16)

**Fastness to light** Note 5-7, ISO 105-B02

**Fastness to rubbing** (ISO) dry 3-5, wet 3-5

**Pilling** Note 3, EN ISO 12945



## Memory 2 (20 colors)

kvadrat

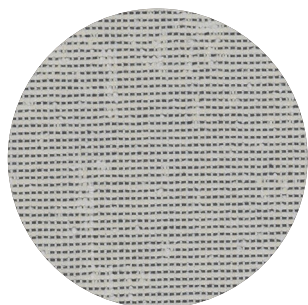

**Category** E

**Composition** 100% Trevira CS

**Weight** 700 g/lin.m

**Abrasion resistance**

35.000 rubs acc. to the Martindale method, EN ISO 12947

**Flammability** EN 1021-1/2 | DIN 4102 B1 | Önorm B1/Q1

NF D 60 013 | NF P 92 507 M1 | UNI 9175 11M

UNI 9177 classe 1 | US Cal. Tech. Bull. 117

IMO A.652 (16)

**Fastness to light** Note 5-8, ISO 105-B02

**Fastness to rubbing** (ISO) dry 4-5, wet 4-5

**Pilling** Note 4, EN ISO 12945

