



Product Specification Sheet

BuzziTrom US

— By BuzziSpace Studio

Functional lighting with acoustic power

BuzziTrom is the first functional acoustic lighting solution crafted from a dual layer of felt that works on speech and high-tones. Along with an integrated LED disk, this acoustic lighting pendant houses an enclosed 4 cm air cavity that ensures maximum acoustic performance. Its cylindrical design traps sound waves within the radius of its frame; meanwhile, the exterior helps to diffuse sound energy.

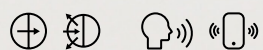

The Family

Sizes

BuzziTrom S

BuzziTrom M

BuzziTrom L

Lighting Unit

LED Disk
Ø 470

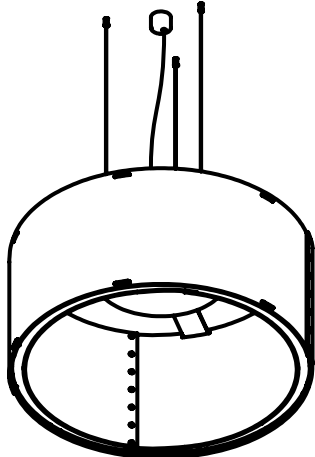
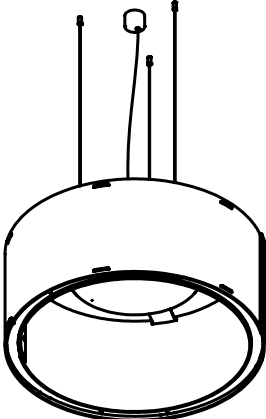
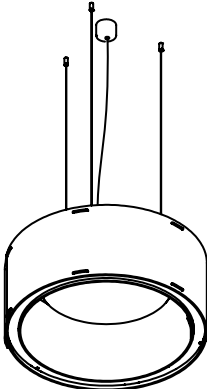

Required order information

- 1. Size
- 2. BuzziFelt Color
- 3. Mounting Option
- 4. Option

Lighting Data

Lighting Unit

LED Disk Ø 470

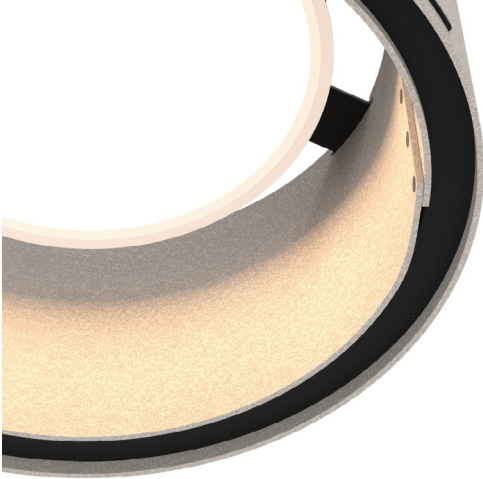

The PMMA diffuser ensures an optimal light spread and efficiency. It creates a very diffuse light surface without any dottiness. The light source of the BuzziTrom is a LED PCB, containing 36 low power LED's.

Lighting specifications

BuzziTrom S

Lighting Unit	Voltage	Wattage	Light Output Luminaire	Efficacy (Lm/W)	CRI	Dimming	Color Temperature	UGR	Standard (stock) On request (>LT)	Color Power Cable	Color Ceiling Canopy	Color Metal Frame	Fabric Collection	Fabric Color	Bicolor	Mounting Option
LED Disk Ø470	120-277V	29W	2545 Lm	88	90	1-10V	3000K	22	Standard	Transparent	White	Black	Use color codes below	Use color codes below	Yes/No	Straight or Split 3 cables of 78.74" or 157.48" in Alu or Black

BuzziTrom M

Lighting Unit	Voltage	Wattage	Light Output Luminaire	Efficacy (Lm/W)	CRI	Dimming	Color Temperature	UGR	Standard (stock) On request (>LT)	Color Power Cable	Color Ceiling Canopy	Color Metal Frame	Fabric Collection	Fabric Color	Bicolor	Mounting Option
LED Disk Ø470	120-277V	29W	2545 Lm	88	90	1-10V	3000K	22	Standard	Transparent	White	Black	Use color codes below	Use color codes below	Yes/No	Straight or Split 3 cables of 78.74" or 157.48" in Alu or Black

BuzziTrom L

Lighting Unit	Voltage	Wattage	Light Output Luminaire	Efficacy (Lm/W)	CRI	Dimming	Color Temperature	UGR	Standard (stock) On request (>LT)	Color Power Cable	Color Ceiling Canopy	Color Metal Frame	Fabric Collection	Fabric Color	Bicolor	Mounting Option
LED Disk Ø470	120-277V	29W	2545 Lm	88	90	1-10V	3000K	22	Standard	Transparent	White	Black	Use color codes below	Use color codes below	Yes/No	Straight 3 cables of 78.74" or 157.48" in Alu or Black



Photometric Data

BuzziTrom S | M | L LED Disk Ø 470

LED Disk Ø 470 Cartesian diagram

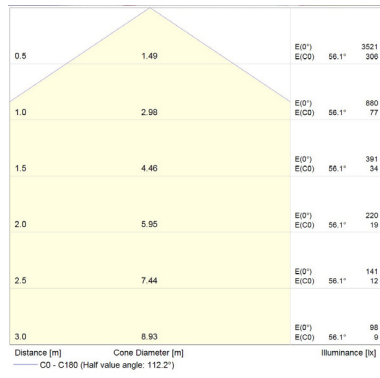

LED Disk Ø 470 Polar curve

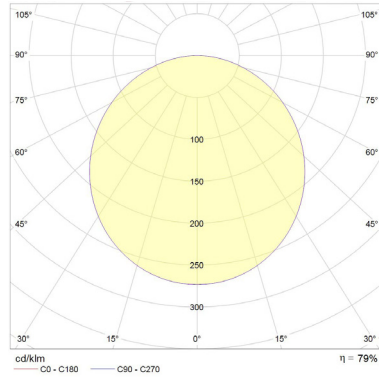

Tips and Tricks - Light Options

To enlight your workplace with optimal lux levels take following measurements into account:

BuzziTrom S | M | L LED Disk Ø 470

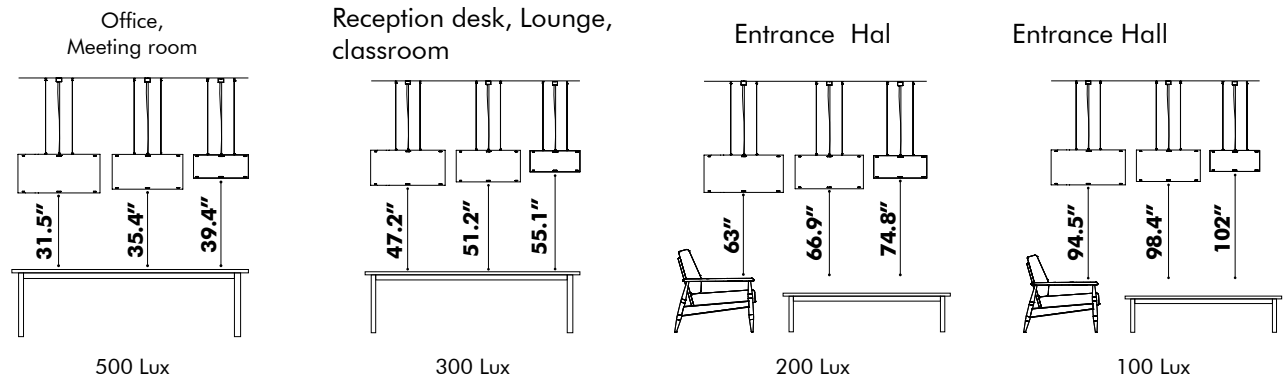

* According to EN12464

Product Data

Fixing System

Ceiling Suspended Split

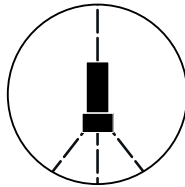
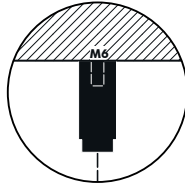
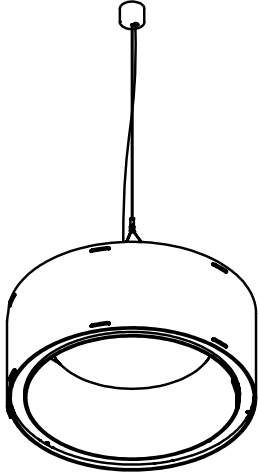

Ceiling Suspended Split
Fixing System Screw with 3 split cables and 1 main cable, total length of 78.74" or 157.48"
(black or alu)
Min. distance of shade to ceiling is 19.70"

Ceiling Suspended Straight

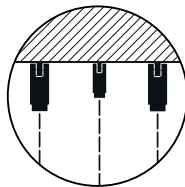
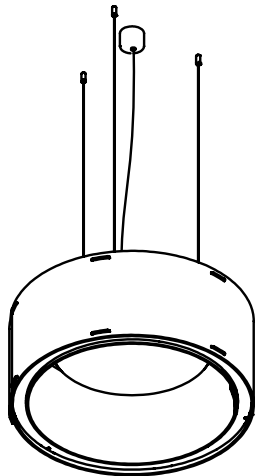

Ceiling Suspended Straight
Fixing System Screw with 3 cables of 78.74" or 157.48" (black or alu)
Min. distance of shade to ceiling is 3.90"

⚠ If installing on suspended ceiling, verify load capacity prior to installation.

Acoustic Shade



The acoustic shade consists of two layers of BuzziFelt, finished with push buttons in glossy black.

The Light source is wrapped with a felt ring in the same felt color as the inside of the shade.

Bicolor is optional: inside/outside in a different BuzziFelt color.



Diffusion



Attenuation



Mid tone



High tone

Acoustics

BuzziTrom Equivalent sound absorption area in m² per object

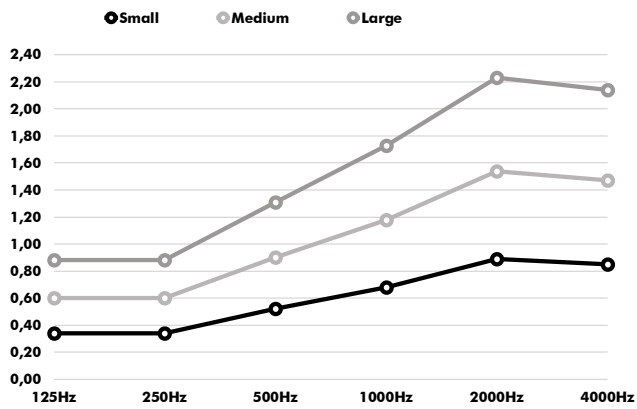

Hz	S Aeq/m ²	M Aeq/m ²	L Aeq/m ²
125	0.34	0.60	0.88
250	0.34	0.60	0.88
500	0.52	0.90	1.31
1000	0.68	1.18	1.73
2000	0.89	1.54	2.23
4000	0.85	1.47	2.14

Dimensions

BuzziTrom S

Straight

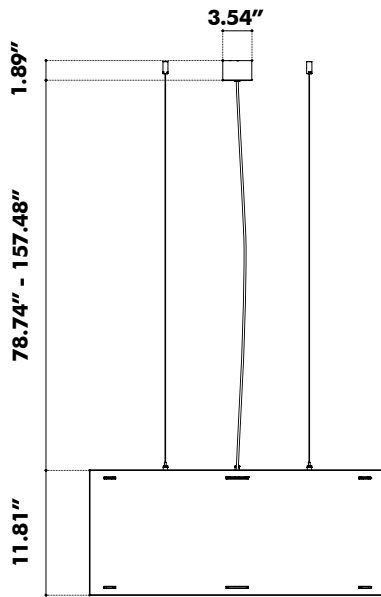

Split

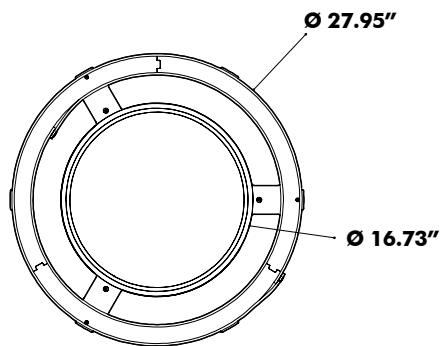
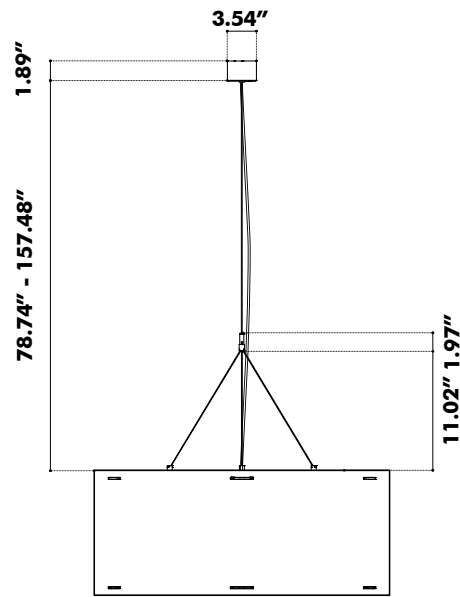

BuzziTrom M

Straight

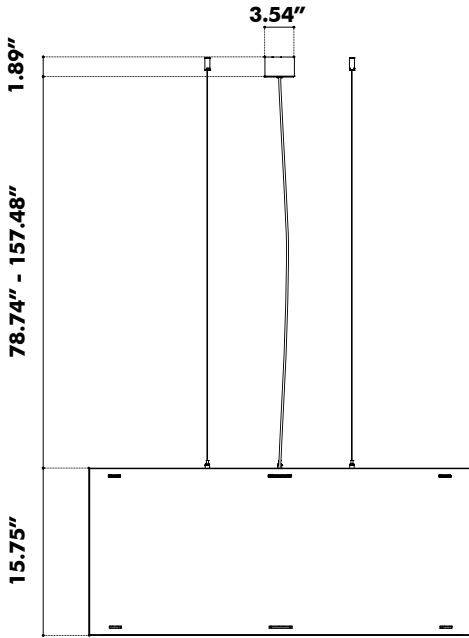

Split

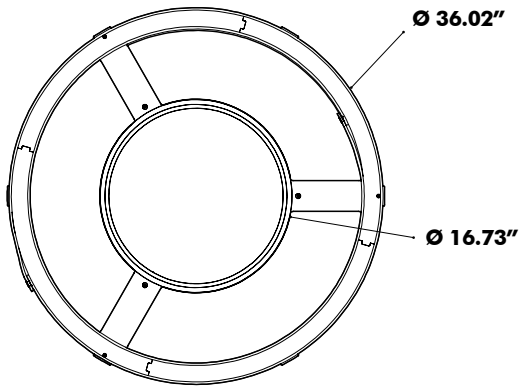
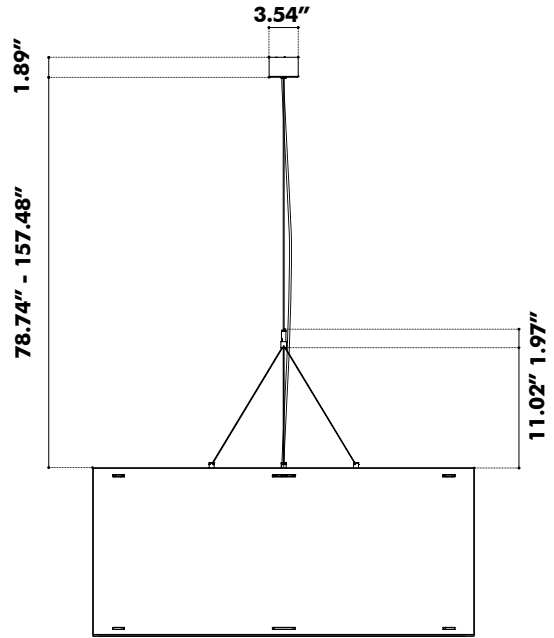

BuzziTrom L

Straight

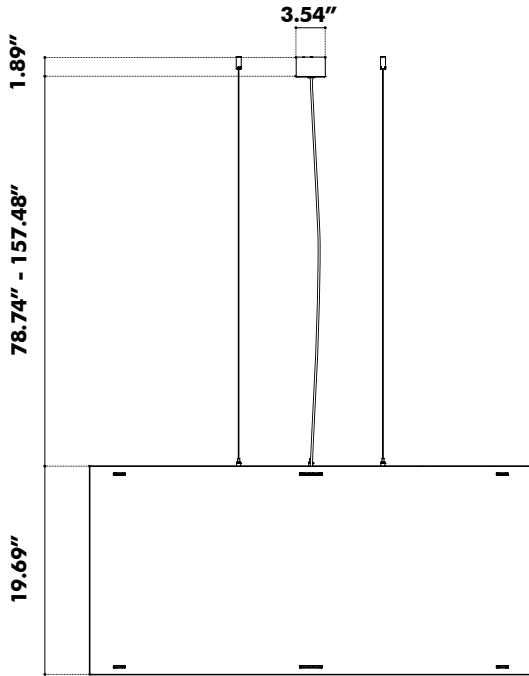

Split

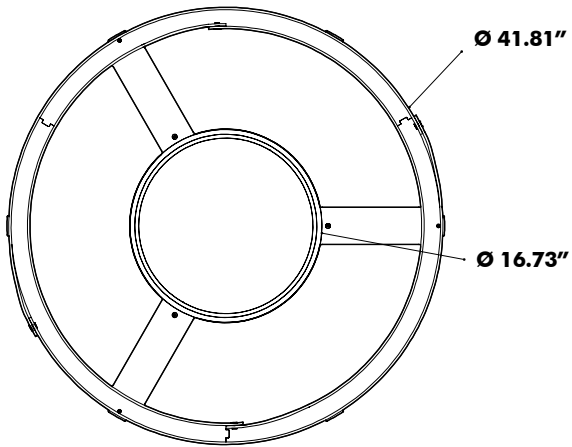
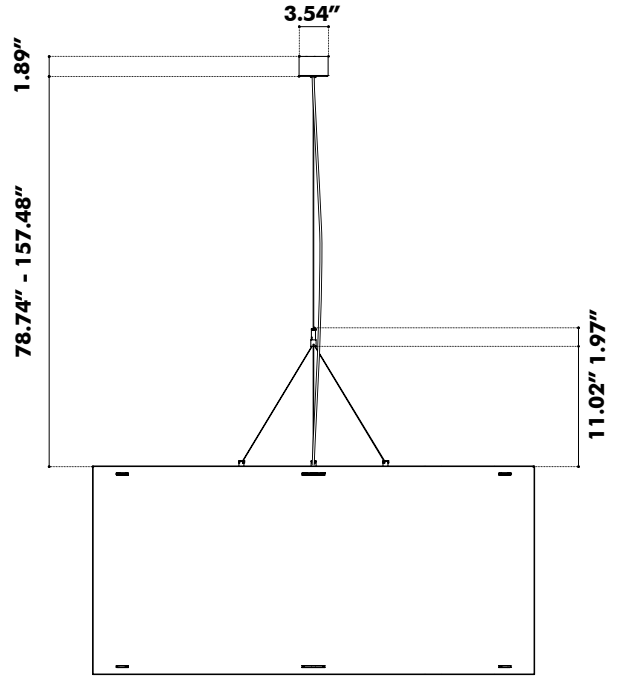

Weights

BuzziTrom S

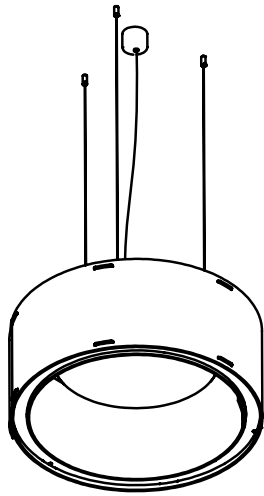

⚖️ 22.93 lbs

BuzziTrom M

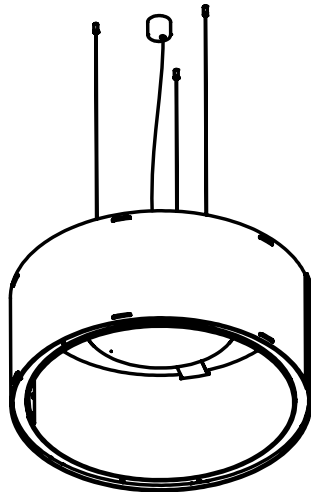

⚖️ 27.78 lbs

BuzziTrom L

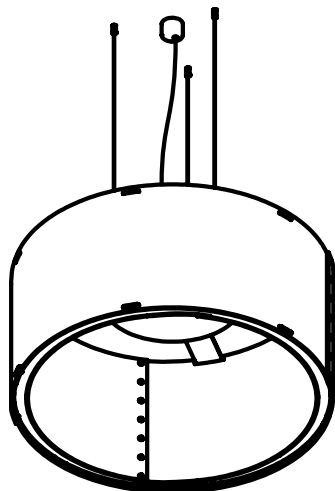

⚖️ 30.42 lbs

Fabrics

Felt (12 colors)

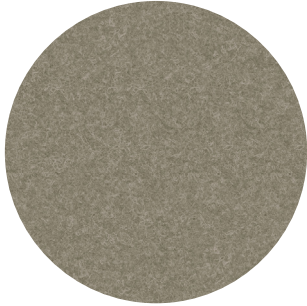

Composition 100% Recycled PE.T. Felt, latex backing

Weight 1.000 g/m2 | 29.49 oz/yd2

Abrasion resistance >7.000 Martindale

Flammability EU: EN 13501.1 + A1/2009 Class B-s1,d0
USA: ASTM E84 Class A certified

Fastness to light USA 5

