BuzziShield Free Product Specification Sheet

This document contains technical
information about the BuzziShield Free



www.buzzi.space







A cozy office divider

BuzziShield Free is unlike your usual room and office dividers and won't create a cold atmosphere as its glass or plastic counterparts do. Due to its voluminous upholstered body, this divider effectively absorbs sound while adding a colorful element into any workspace. The lightweight and adaptable BuzziShield Free works well on its own as a partition between desks to create private workstations for both seated and standing desks. Or combine more than one to introduce natural flows in an open space.

The versatile BuzziShield Free arrives in two different heights, Medium (150 cm/ 59") and High (180 cm/71"); two different widths (120 cm/47" and 160 cm/63"); and can be dressed in a variety of fabrics and colors to suit your decor needs. You can also pin notes, pictures, or whatever you like into BuzziShield Free to truly make it your own.

Design by BuzziSpace Studio

General

-  BuzziShield Free
Free | Arc
Medium | High
-  Upholstered acoustic foam element
Baseplate: powder coated metal in black (RAL 9005)
Cover: Fabric, Trevira CS+ | CS, Revive 1, Velvet, Clara 2, Remix 3, Hero 2, Tonus 4, Memory 2
-  Dry Use
-  Flat Packed
Unassembled

Acoustics







Content

| | |
|----------------|----|
| Configurations | 3 |
| Components | 4 |
| Fabrics | 5 |
| Dimensions | 8 |
| Acoustics | 12 |

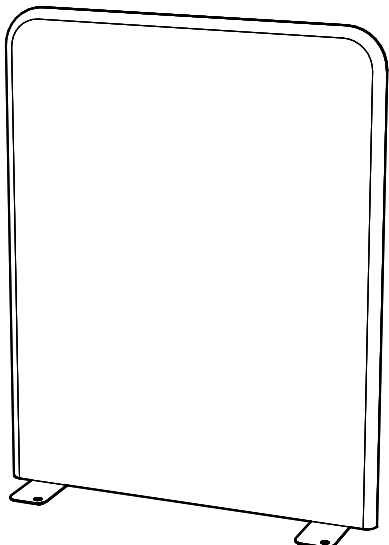
Configuration



BuzziShield Free Medium

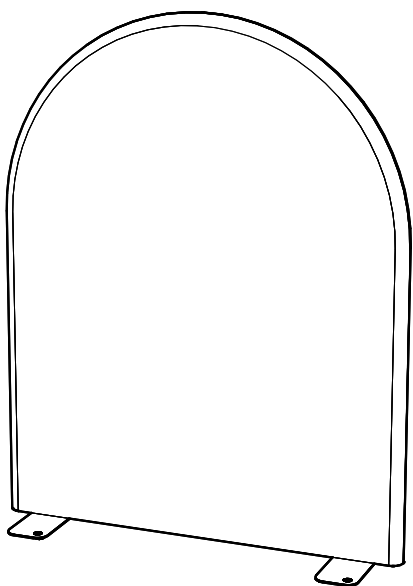

-  Upholstered acoustic foam element
Baseplate: powder coated metal in black (RAL 9005)
Cover: Fabric, Trevira CS+ | CS, Revive 1, Velvet, Clara 2, Remix 3, Hero 2, Tonus 4, Memory 2
-  Height: 150 cm | 59.06"
Width: 120 cm or 160 cm
47.24" or 62.99"
-  Width 120 cm: 11,4 kg | 25.13 lbs
Width 160 cm: 15,3 kg | 33.73 lbs

BuzziShield Free Arc Medium



-  Upholstered acoustic foam element
Baseplate: powder coated metal in black (RAL 9005)
Cover: Fabric, Trevira CS+ | CS, Revive 1, Velvet, Clara 2, Remix 3, Hero 2, Tonus 4, Memory 2
-  Height: 150 cm | 59.06"
Width: 120 cm or 160 cm
47.24" or 62.99"
-  Width 120 cm: 11 kg | 24.25 lbs
Width 160 cm: 13,5 kg | 29.76 lbs

BuzziShield Free High

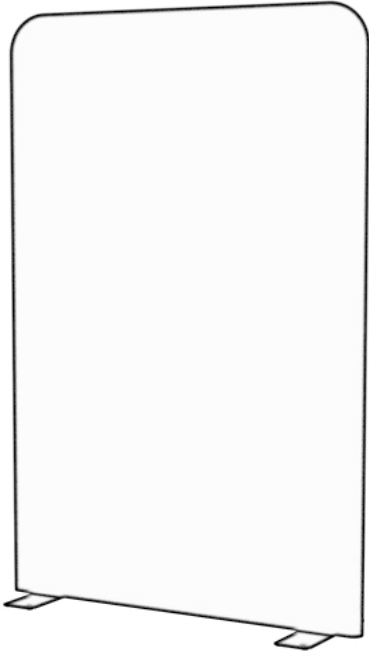

- Upholstered acoustic foam element
- Baseplate: powder coated metal in black (RAL 9005)
- Cover: Fabric, Trevira CS+ | CS, Revive 1, Velvet, Clara 2, Remix 3, Hero 2, Tonus 4, Memory 2
- Height: 180 cm | 70.87"
- Width: 120 cm or 160 cm
47.24" or 62.99"
- Width 120 cm: 12,85 kg | 28.33 lbs
- Width 160 cm: 17 kg | 37.48 lbs

BuzziShield Free Arc High

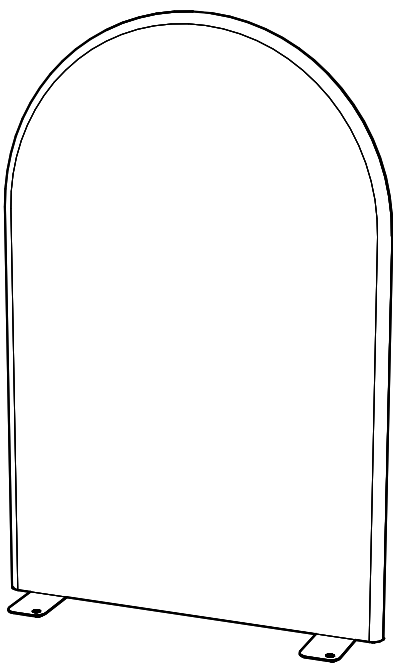

- Upholstered acoustic foam element
- Baseplate: powder coated metal in black (RAL 9005)
- Cover: Fabric, Trevira CS+ | CS, Revive 1, Velvet, Clara 2, Remix 3, Hero 2, Tonus 4, Memory 2
- Height: 180 cm | 70.87"
- Width: 120 cm or 160 cm
47.24" or 62.99"
- Width 120 cm: 12,5 kg | lbs
- Width 160 cm: 16 kg | lbs

Components

Baseplate

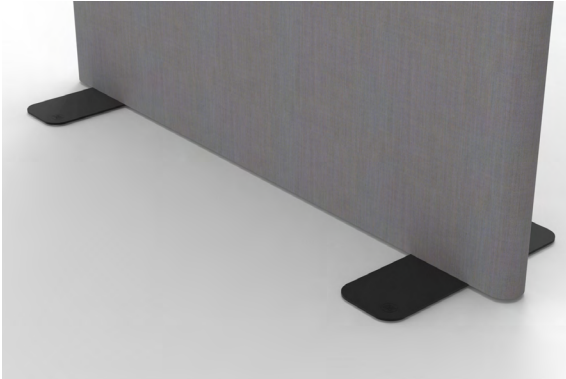

2 baseplates included in powder coated black metal (RAL 9005)

Fabrics

Fabric (45 colors)

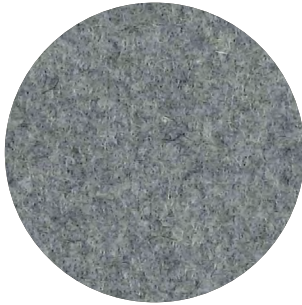

Category A

Composition 70% Recycled Wool, 25% Recycled Polyacryl,
5% Recycled Other Fabrics

Weight 405 g/m² | 11.94 oz/yd²

Abrasion resistance 40.000 Martindale, 50,000 Wyzenbeek

Flammability EU: EN 1021.1/2006 | BS EN 1021.1/2006 (cigarette).
EN 1021.2/2006 | BS EN 1021.2/2006 (match)
USA: CAL TB 117 | ASTM E84 CLASS A

Fastness to light EU: 4 | USA 4

Fastness to rubbing EU: Wet 3-4 | Dry 4-5

Fastness to crocking USA: Wet 5 | Dry 5



Trevira CS+ | CS (45 colors)

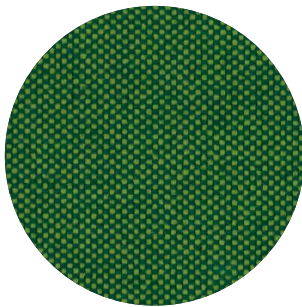

Category A

Weight 420 g/m² | 12.39 oz/yd²

Composition 100% Polyester, Trevira CS

Abrasion resistance 100.000 Martindale, 90,000 Wyzenbeek

Flammability BS 5852 part II: CRIB 5 | BS 7176 Medium Hazard
USA: CAL TB 117 | M1 | B1 | EN 1021/1-2 | C1 |
IMO Res. A652 (16)

Fastness to light EU: 6 | USA 5

Fastness to rubbing EU: Wet 4-5 | Dry 4-5

Fastness to crocking USA: Wet 5 | Dry 5



Revive 1 (25 colors)

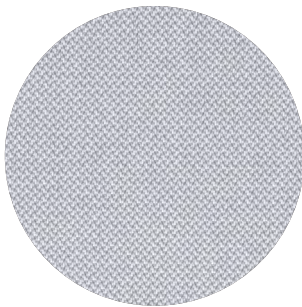

Category A

Composition 100% recycled polyester FR

Weight 430 g/lin.m

Abrasion resistance 60.000 Martindale rubs, EN ISO 12947

Flammability EN 1021-1/2 | DIN 4102 B1 | Önorm B1/Q1
UNI 9175 1IM | US Cal. Tech. Bull. 117
IMO A.652 (16)

Fastness to light Note 5-7, ISO 105-B02

Fastness to rubbing (ISO) dry 5, wet 4-5

Pilling Note 4-5, EN ISO 12945



kvadrat

Velvet (12 colors)

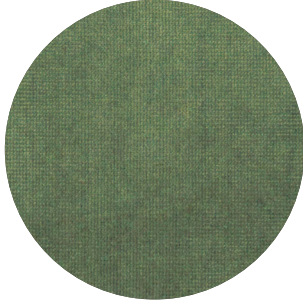

Category B

Composition 100% PES

Weight 375 g/m² | 11.06 oz/yd²

Abrasion resistance > 100.000 Martindale

Fastness to light EU: 4-5

Fastness to rubbing EU: Wet 4 | Dry 4-5

Pilling EU: 4-5

Clara 2 (24 colors)

kvadrat

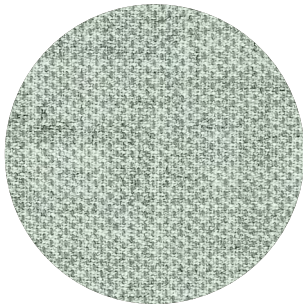

Category B

Composition 92% new wool, 8% nylon

Weight 400 g/lin.m

Abrasion resistance 80.000 Martindale rubs, EN ISO 12947

Flammability EN 1021-1/2 | BS 5852, ignition source 2-3 | DIN 4102 B2
NF D 60 013 | UNI 9175 1IM | US Cal. Tech. Bull. 117, Sec. E
NFPA 260 | IMO A.652(16)

Fastness to light Note 5-7, ISO 105-B02

Fastness to rubbing (ISO) dry 4-5, wet 4

Pilling Note 4, EN ISO 12945



Remix 3 (73 colors)

kvadrat



Category B

Composition 90% new wool, 10% nylon

Weight 415 g/lin.m

Abrasion resistance 100.000 Martindale rubs, EN ISO 12947

Flammability EN 1021-1/2 | BS 5852 part 1
Önorm B1/Q1 | NF D 60 013 | UNI 9175, 1IM
AS/NZS 1530.3 | Cal. Tech. Bull. 117-2013
NFPA 260 | IMO FTP Code 2010:Part 8

Fastness to light Note 5-7, ISO 105-B02

Fastness to rubbing (ISO) dry 4-5, wet 4

Pilling Note 4, EN ISO 12945



Hero 2 (33 colors)

kvadrat

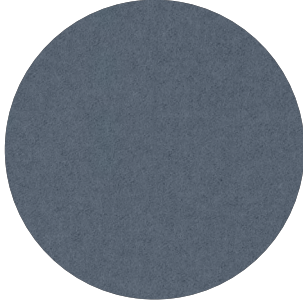

Category C

Composition 97% new wool, 3% nylon

Weight 580 g/lin.m

Abrasion resistance 45.000 Martindale rubs, EN ISO 12947

Flammability EN 1021-1/2 | DIN 4102 B2 | NF D 60 013
UNI 9175 11M | US Cal. Bull. 117-2013 | NFPA 260
IMO A.652 (16)

Fastness to light Note 5-6, ISO 105-B02

Fastness to rubbing (ISO) dry 4-5, wet 4-5

Pilling Note 3-4, EN ISO 12945



Tonus 4 (47 colors)

kvadrat



Category D

Composition 90% new wool, 10% Helanca

Weight 665 g/lin.m

Abrasion resistance 100.000 Martindale rubs, EN ISO 12947

Flammability EN 1021-1/2 | BS 5852 part 1 | DIN 4102 B2
Önorm B1/Q1 | NF D 60 013 | UNI 9175 11M
US Cal. Bull. 117-2013 | NFPA 260 | IMO A.652 (16)

Fastness to light Note 5-7, ISO 105-B02

Fastness to rubbing (ISO) dry 3-5, wet 3-5

Pilling Note 3, EN ISO 12945



Memory 2 (20 colors)

kvadrat

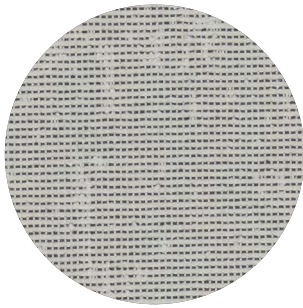

Category E

Composition 100% Trevira CS

Weight 700 g/lin.m

Abrasion resistance

35.000 rubs acc. to the Martindale method, EN ISO 12947

Flammability EN 1021-1/2 | DIN 4102 B1 | Önorm B1/Q1
NF D 60 013 | NF P 92 507 M1 | UNI 9175 11M
UNI 9177 classe 1 | US Cal. Tech. Bull. 117
IMO A.652 (16)

Fastness to light Note 5-8, ISO 105-B02

Fastness to rubbing (ISO) dry 4-5, wet 4-5

Pilling Note 4, EN ISO 12945



Dimensions

BuzziShield Free | Free Arc Medium

Width 120 cm | 47.24"

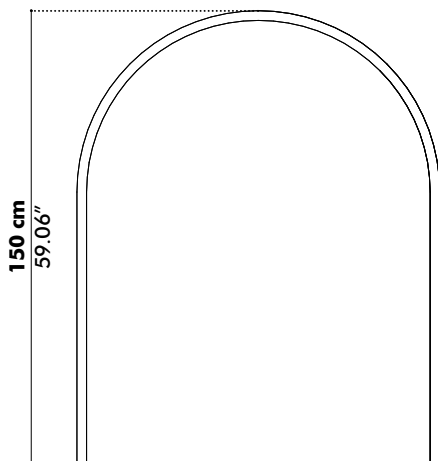
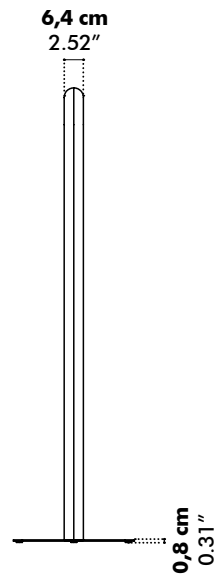
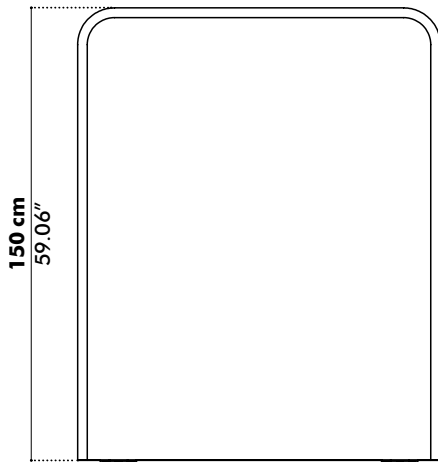
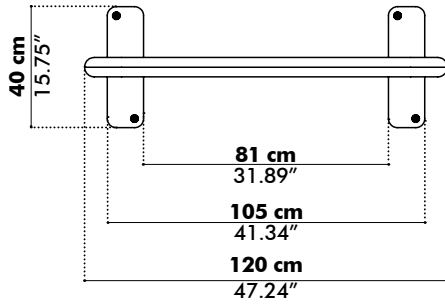

BuzziShield Free | Free Arc Medium

Width 160 cm | 62.99"

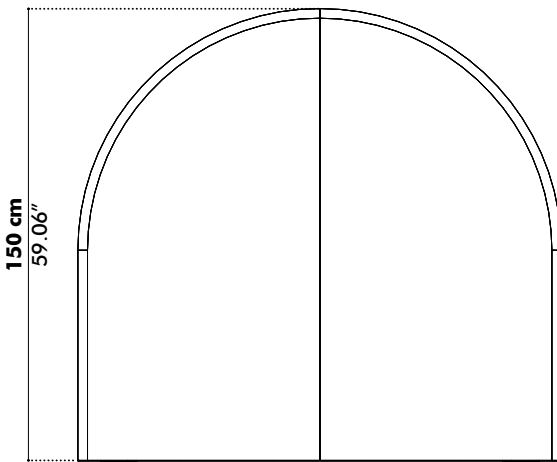
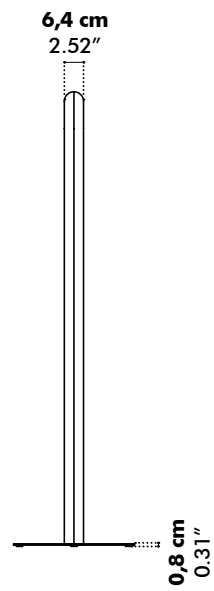
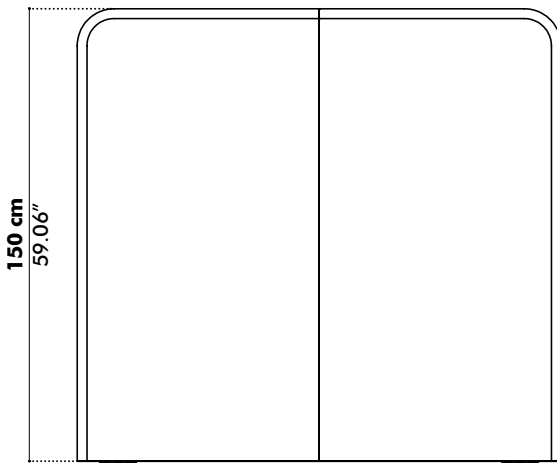
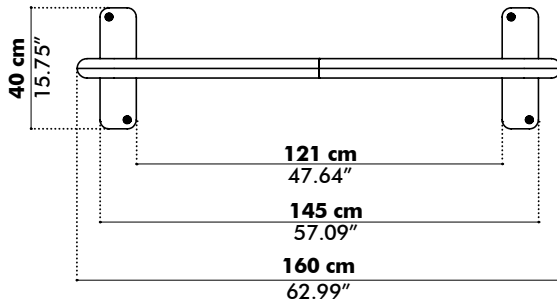

BuzziShield Free | Free Arc High

Width 120 cm | 47.24"

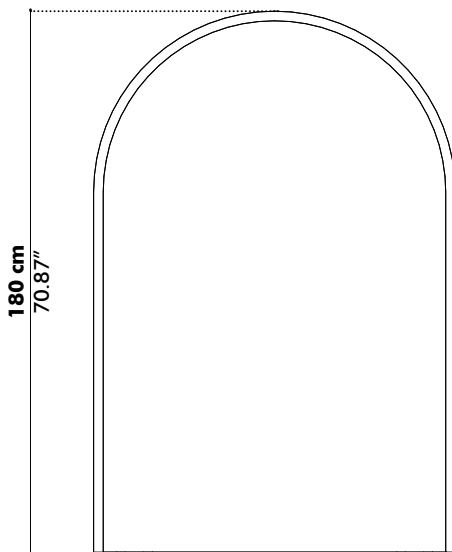
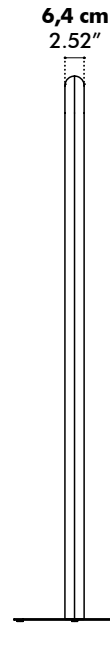
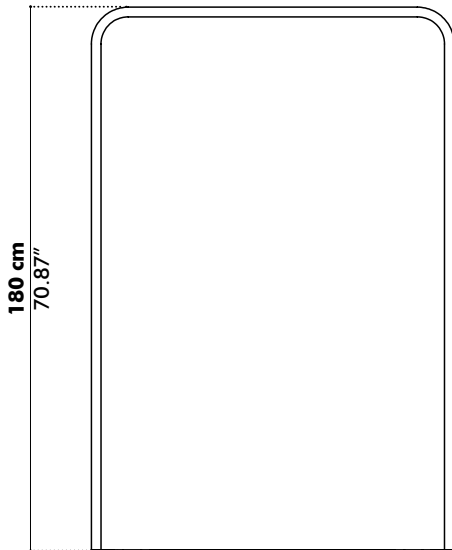
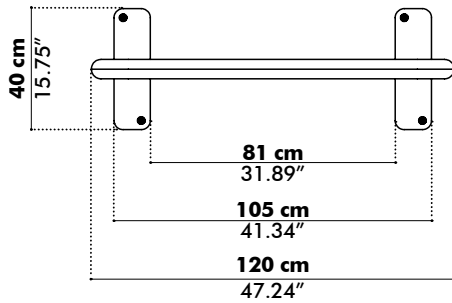

BuzziShield Free | Free Arc High

Width 160 cm | 62.99"

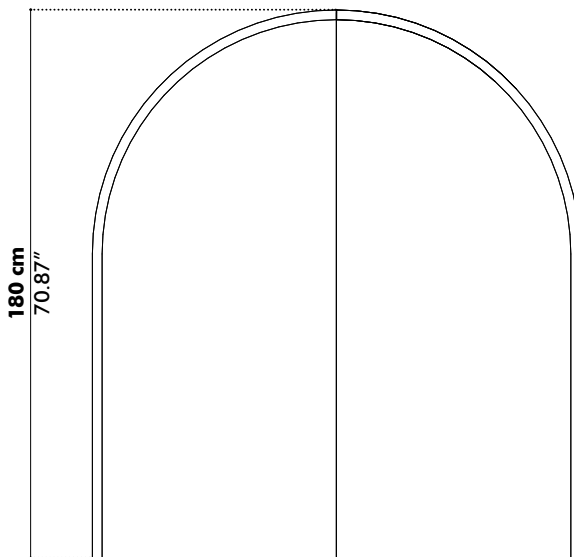
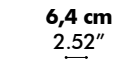
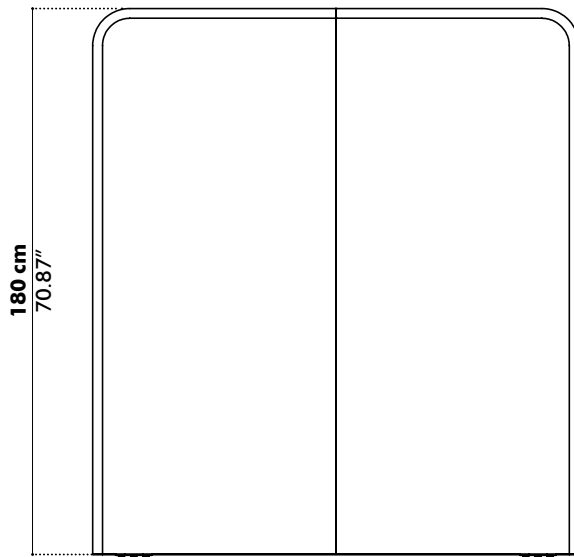
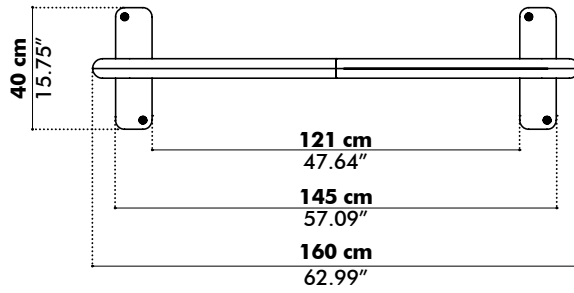

Acoustics

BuzziShield Free

Equivalent sound absorption area in m² per object

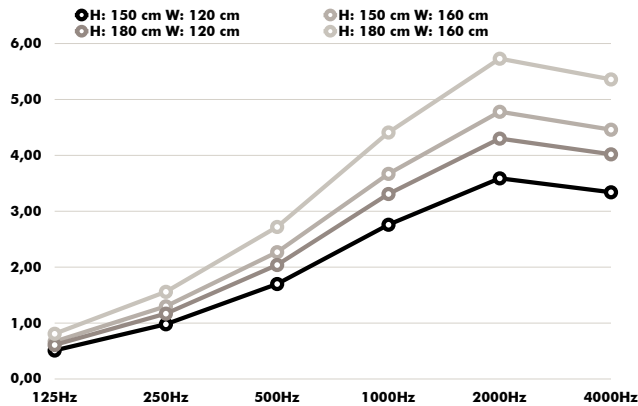

| Hz | H: 150 cm W: 120 cm 59.06" 47.24" Aeq/m ² | H: 150 cm W: 160 cm 59.06" 62.99" Aeq/m ² | H: 180 cm W: 120 cm 70.87" 47.24" Aeq/m ² | H: 180 cm W: 160 cm 70.87" 62.99" Aeq/m ² |
|------|--|--|--|--|
| 125 | 0.51 | 0.67 | 0.61 | 0.81 |
| 250 | 0.98 | 1.30 | 1.17 | 1.56 |
| 500 | 1.70 | 2.27 | 2.04 | 2.72 |
| 1000 | 2.76 | 3.67 | 3.31 | 4.41 |
| 2000 | 3.59 | 4.78 | 4.30 | 5.73 |
| 4000 | 3.34 | 4.46 | 4.02 | 5.36 |

BuzziShield Free Arc

Equivalent sound absorption area in m² per object

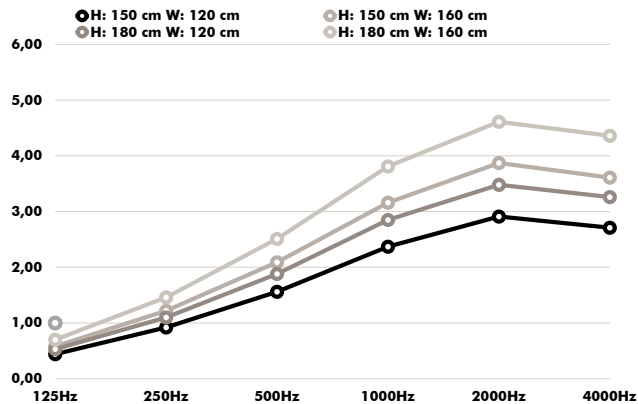

| Hz | H: 150 cm W: 120 cm 59.06" 47.24" Aeq/m ² | H: 150 cm W: 160 cm 59.06" 62.99" Aeq/m ² | H: 180 cm W: 120 cm 70.87" 47.24" Aeq/m ² | H: 180 cm W: 160 cm 70.87" 62.99" Aeq/m ² |
|------|--|--|--|--|
| 125 | 0.44 | 0.58 | 0.53 | 0.70 |
| 250 | 0.92 | 1.22 | 1.10 | 1.46 |
| 500 | 1.56 | 2.09 | 1.88 | 2.51 |
| 1000 | 2.37 | 3.16 | 2.85 | 3.81 |
| 2000 | 2.91 | 3.87 | 3.48 | 4.61 |
| 4000 | 2.71 | 3.61 | 3.26 | 4.36 |