

# BuzziPebl Light

One | Two

INSTALLATION MANUAL  
110-120V

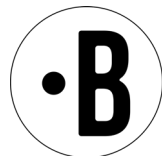
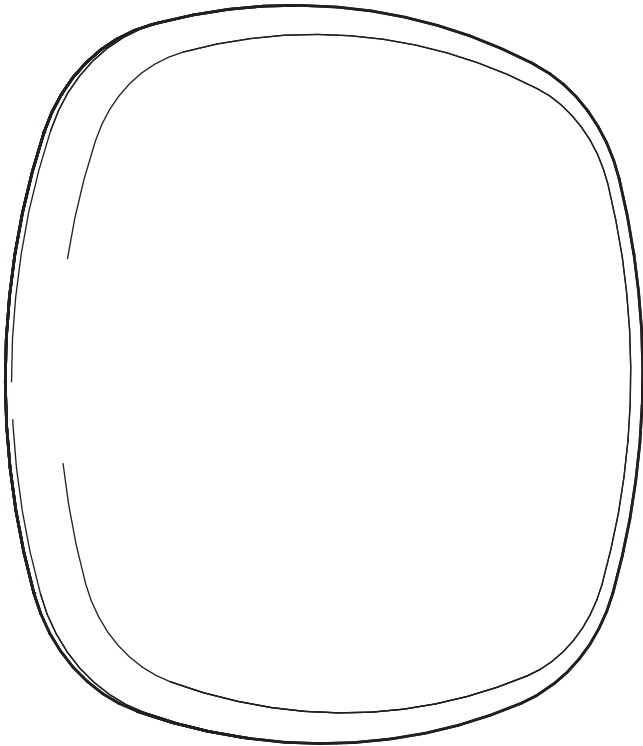

## Technical info

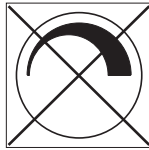
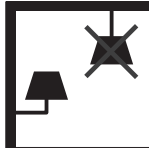
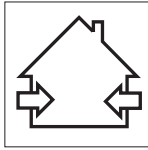

**⚠** The light source of this luminaire is not replaceable; when the light source reaches its end of life the whole luminaire shall be replaced.

## Excluding

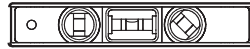
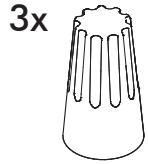
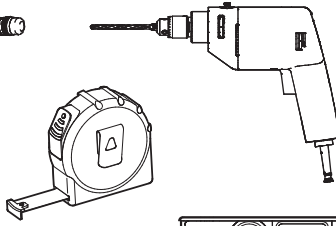
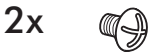

## Including (1 pcs)

**One Medium**

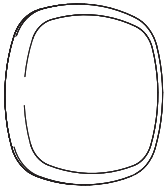

**One Large**

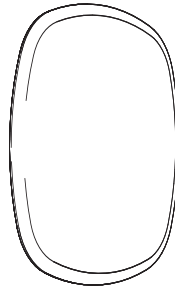

**Two Medium**

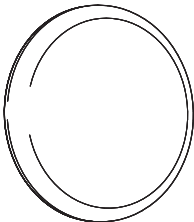

**Two Large**

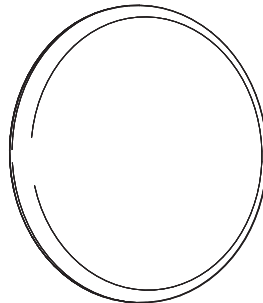

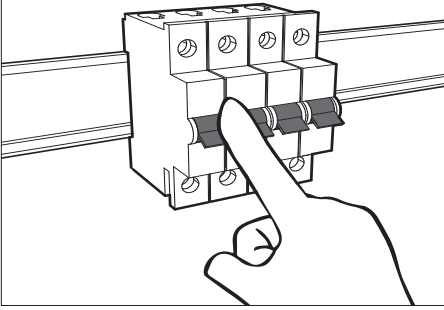
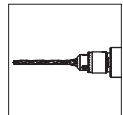
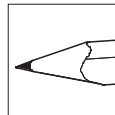
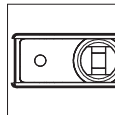
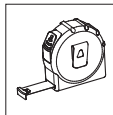
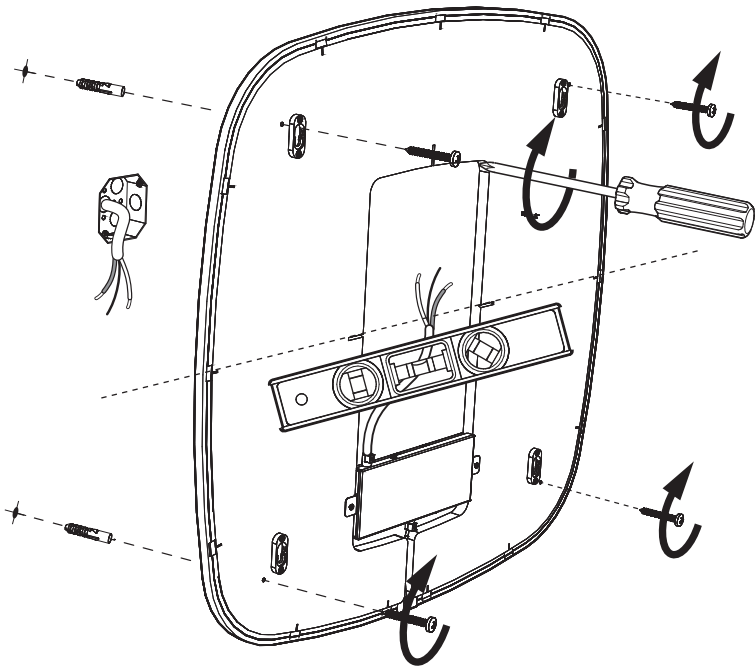
**1****OFF****2**

**3**

White      Neutral  
Black      Line  
Green      Ground

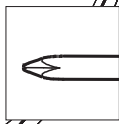
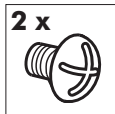
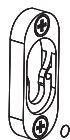
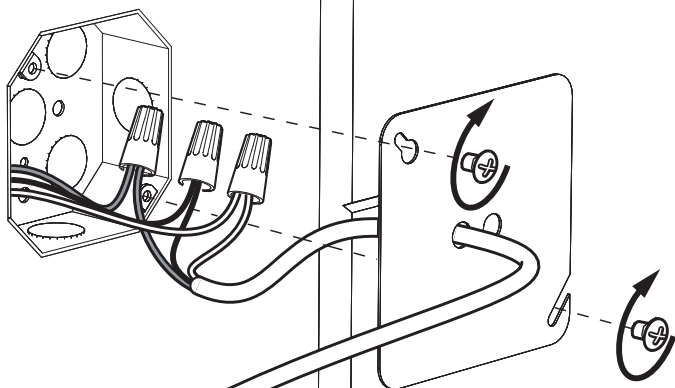
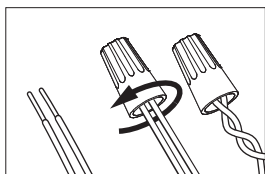

4

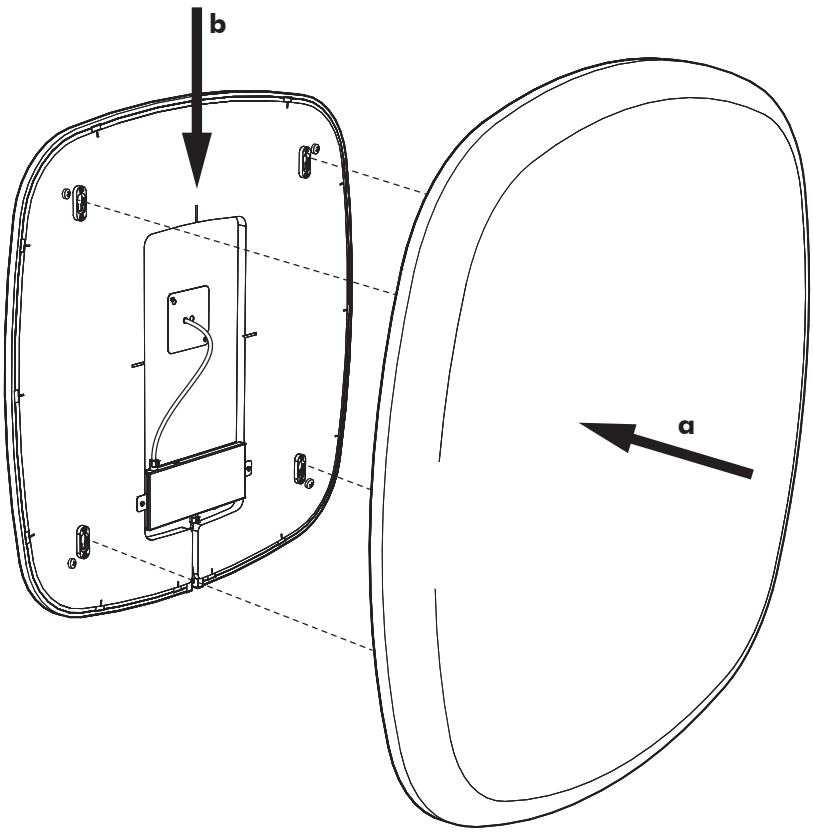





BuzziSpace Group NV  
Italiëlei 8, 2000 Antwerp  
Belgium

☎ +32 (0)3 846 10 00

✉ [info@buzzi.space](mailto:info@buzzi.space)

🌐 [www.buzzi.space](http://www.buzzi.space)



Doc nr.: A-0000007809/01

Last update: 30/11/2023