

BuzziPebl

One | Two

INSTALLATION MANUAL

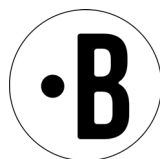

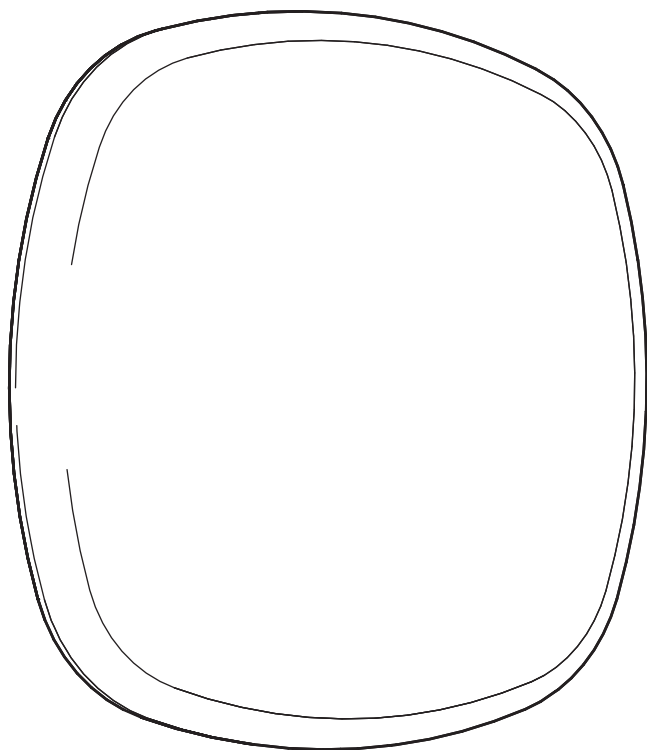
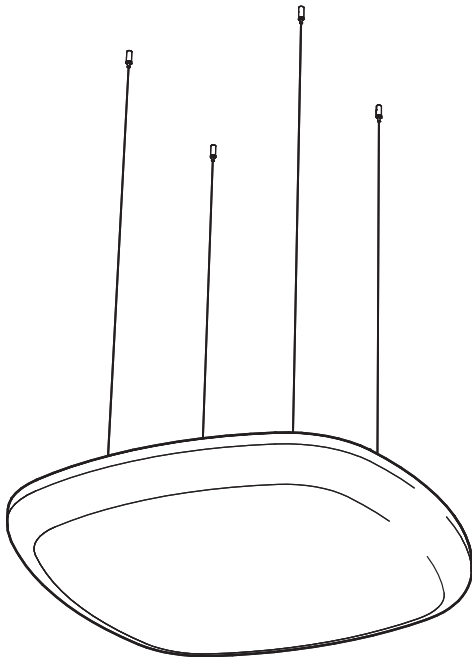
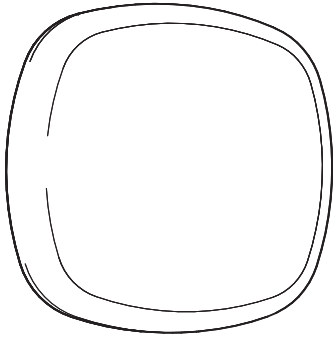

BuzziPebl Wall Mounted

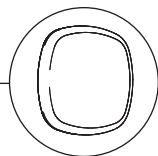

1 PERS.

Excluding



2x



2x

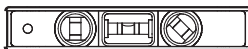
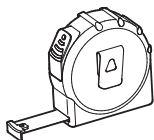
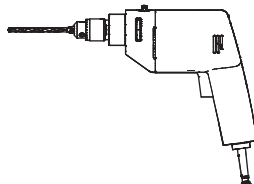

Including (1 pcs)

One Medium

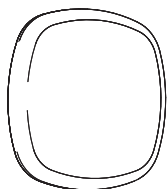

One Large

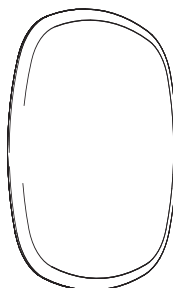

Two Medium

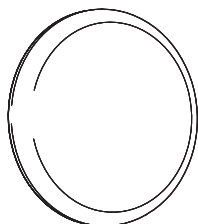

Two Large

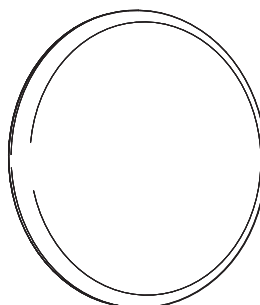

1

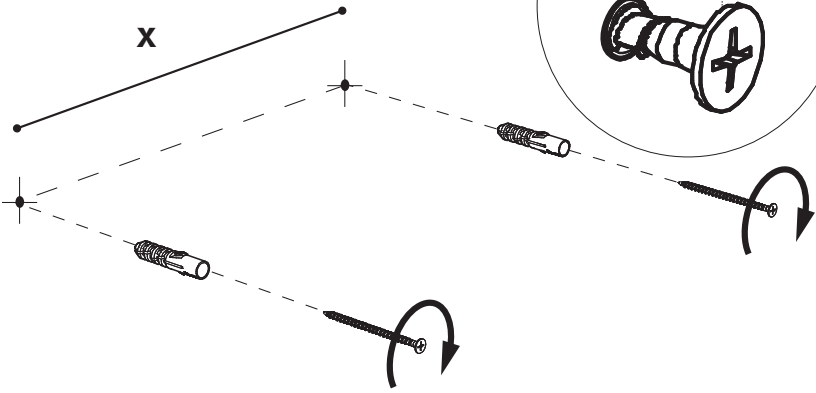

Medium: X: 40 cm | 15.75"
Large: X: 60 cm | 23.62"

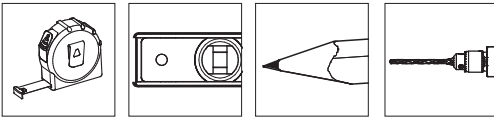

2

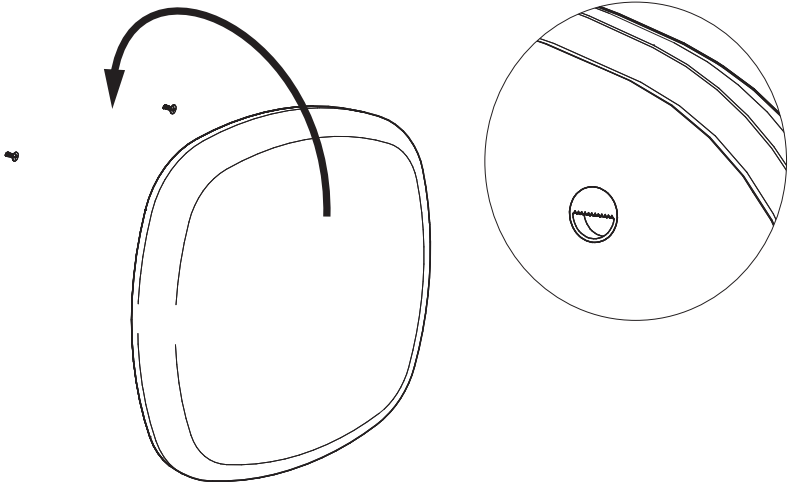

BuzziPebl Ceiling Suspended

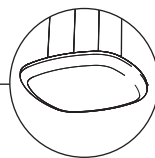

1 PERS. 

Excluding

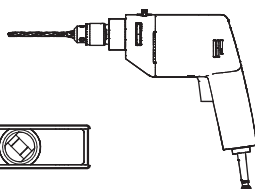
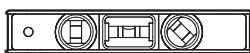
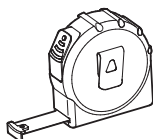

Including

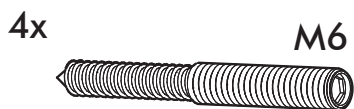
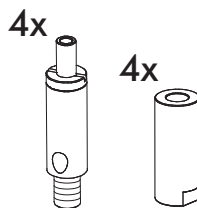
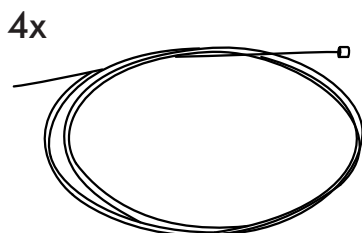

Including (1 pcs)

One Medium

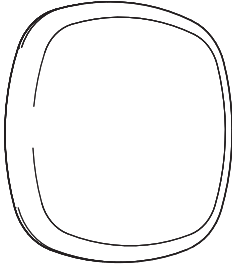

One Large

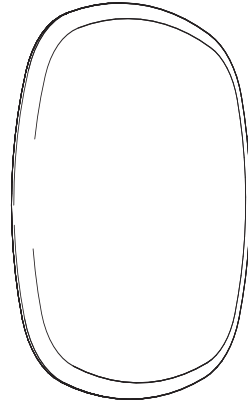

Two Medium

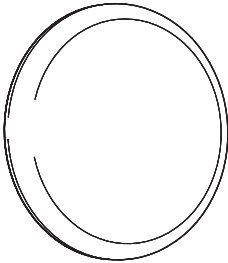

Two Large

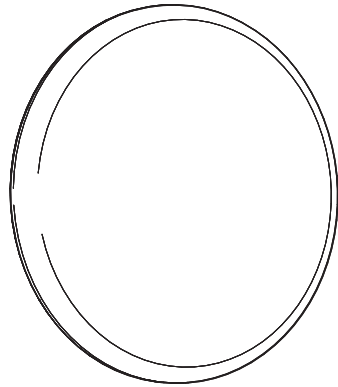

Dimensions Fixing Points

One Medium

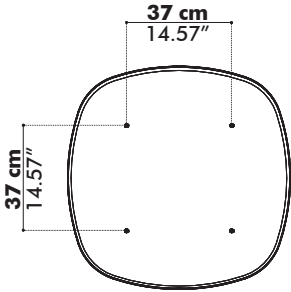

One Large

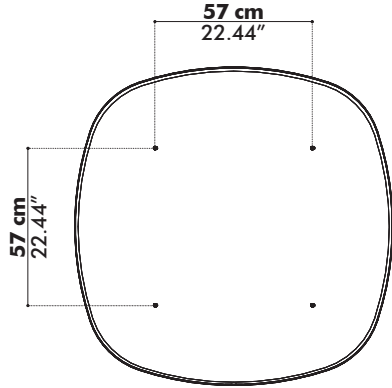

Two Medium

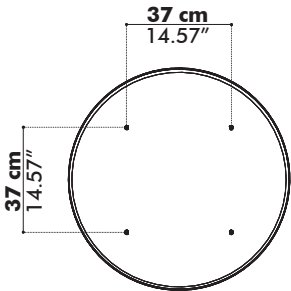

Two Large

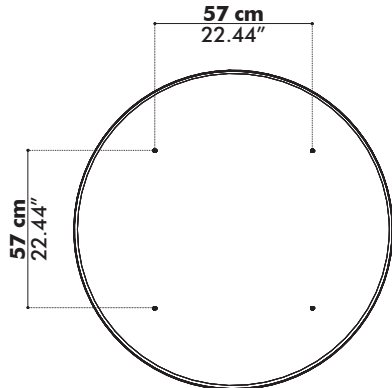

1

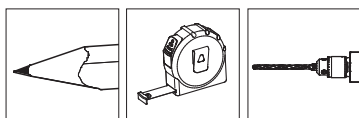
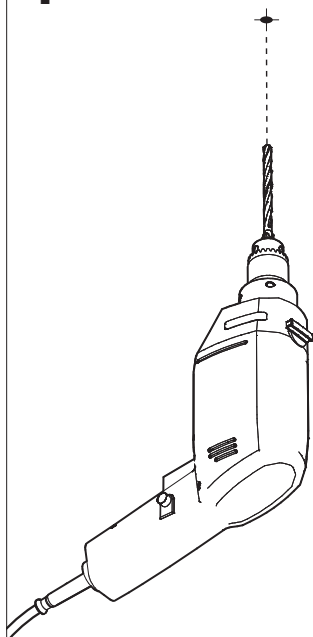

2

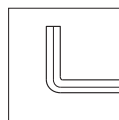
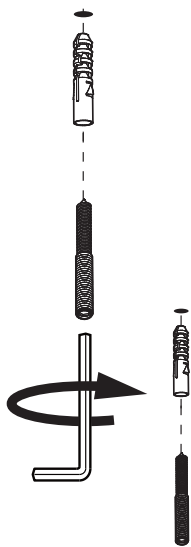

3

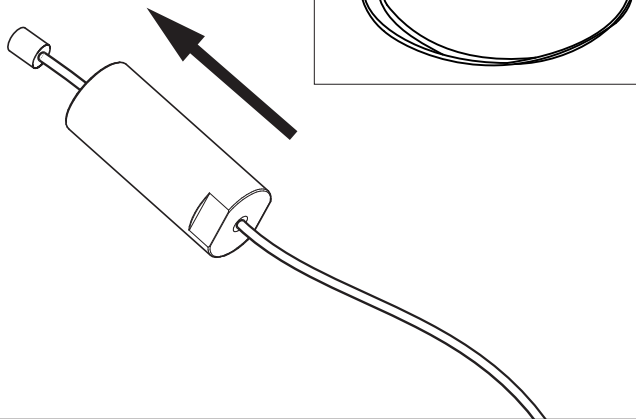

4

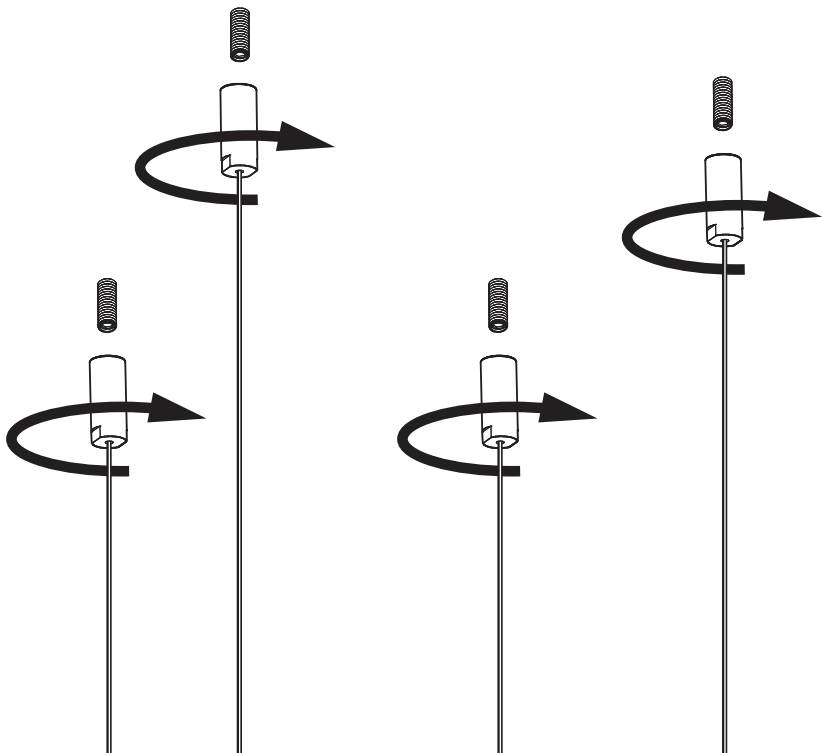

5

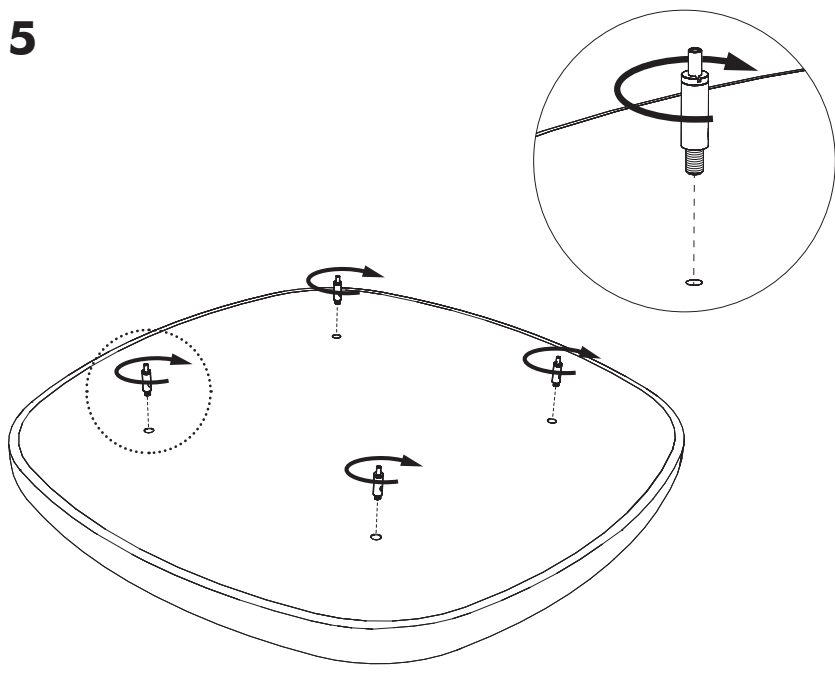

6

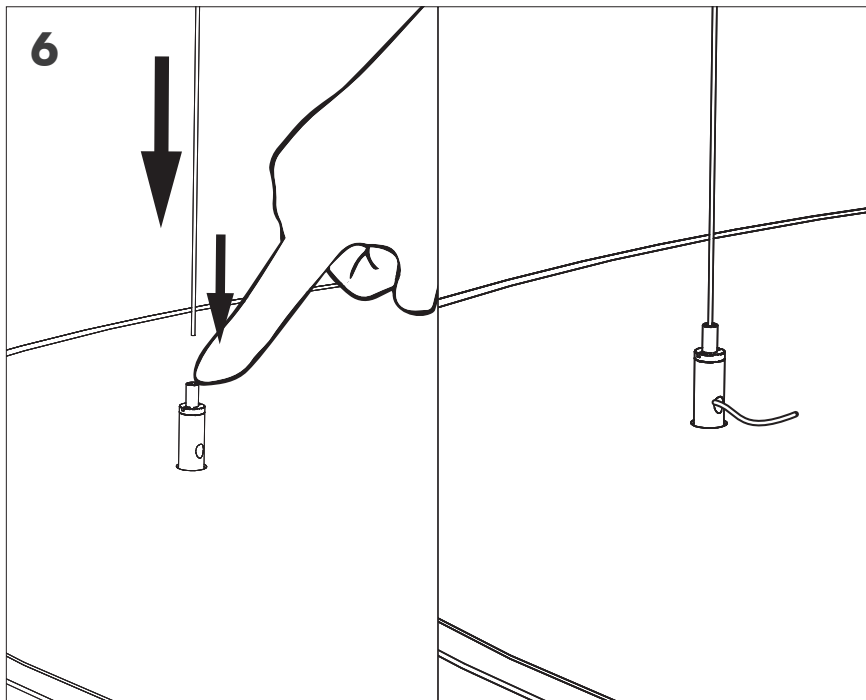

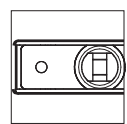
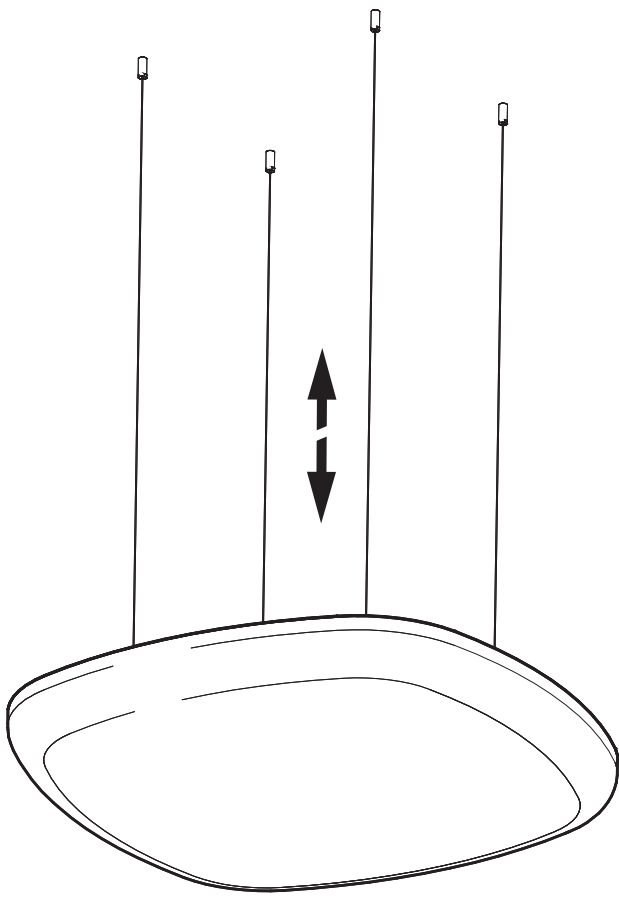
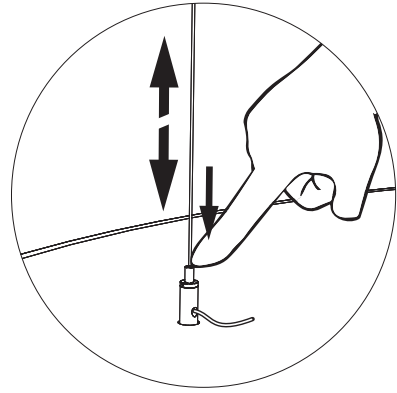

BuzziSpace Group NV
Italiëlei 8, 2000 Antwerp
Belgium

☎ +32 (0)3 846 10 00

✉ info@buzzi.space

🌐 www.buzzi.space



Doc nr.: A-0000007807/02

Last update: 30/11/2023