

BuzziFez

INSTALLATION MANUAL

24V DC MAX. 4.5W

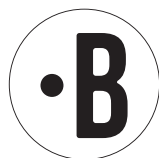
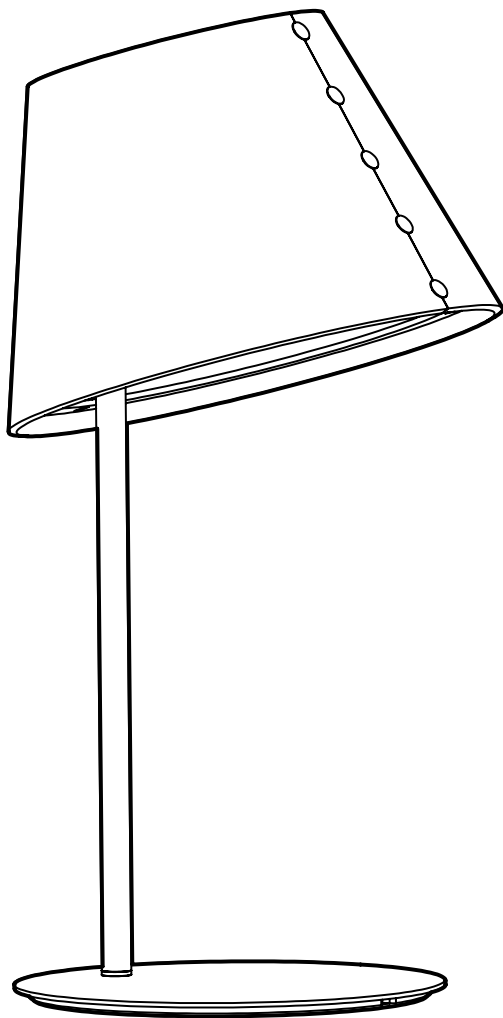

Technical info

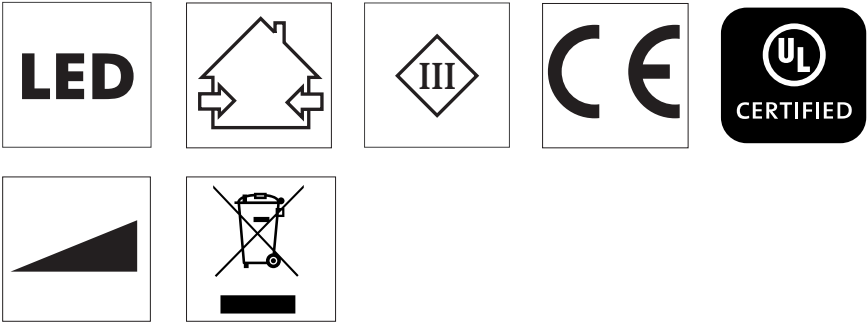

Environmental Protection

Waste electrical products should not be disposed of with household waste. Please recycle where facilities exist. Check with your Local Authority or retailer for recycling advice.

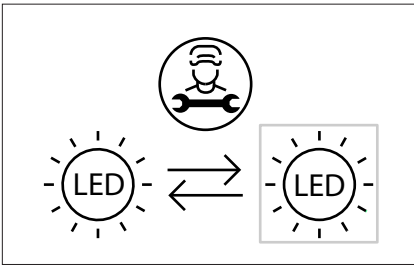

The light source contained in this luminaire shall only be replaced by the manufacturer or his service agent or a similar qualified person.

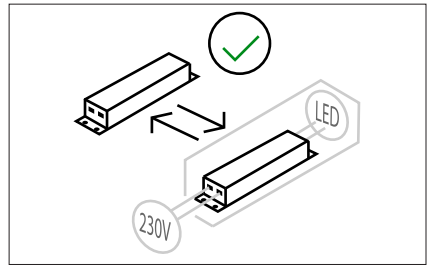

For type Y attachments: if the external flexible cable or cord of this luminaire is damaged, it shall be exclusively replaced by the manufacturer or his service agent or a similar qualified person in order to avoid a hazard.

LED Portable Luminaire should be connected to the supply via a plug-in SELV LED driver UES18LCP1-240075SPA.

Controller related parameter information.

UES18LCP1-240075SPA:

Input: 100-240 V AC; 50 / 60 Hz;

Output: constant voltage 24 V DC; SELV; plug-in.

Included

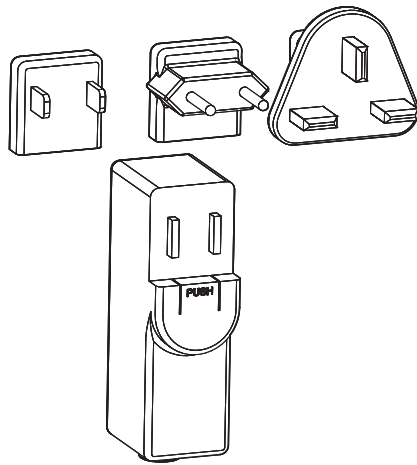
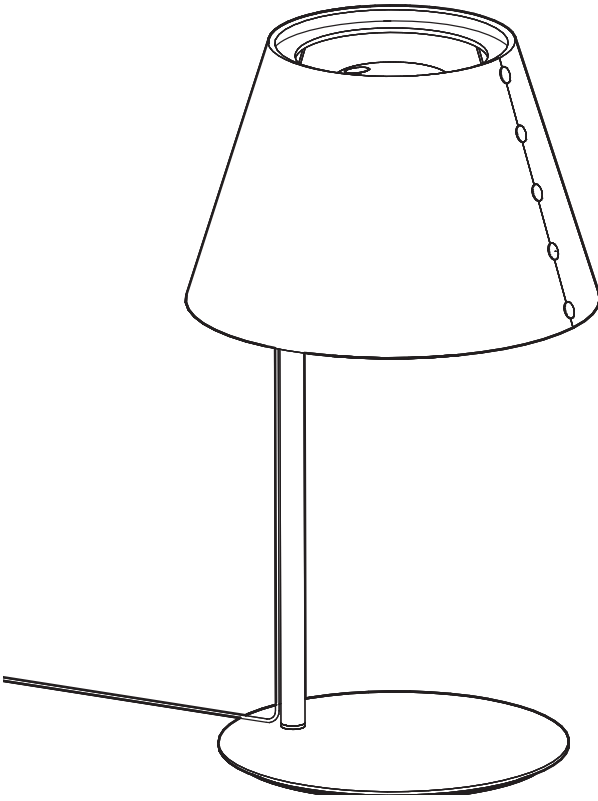



1

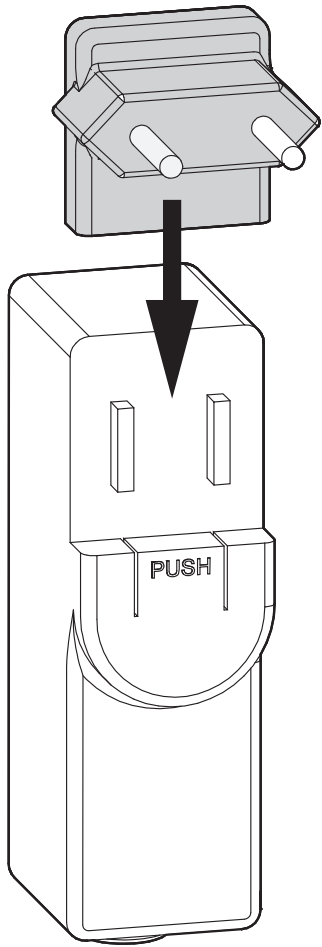

A vertical list of three electrical outlet types, each with a corresponding icon and label. The first icon shows a two-pronged plug with a ground pin, labeled "US". The second icon shows a two-pronged plug with rounded ends, labeled "EU". The third icon shows a three-pronged plug with a triangular shape, labeled "UK".

2

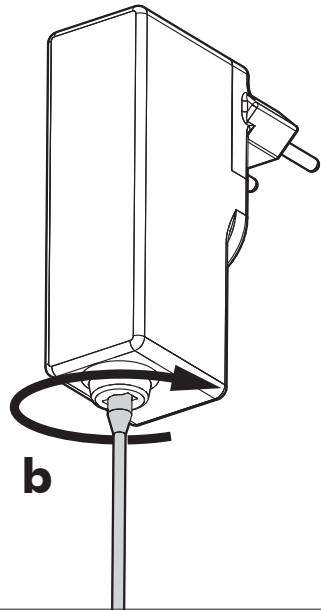
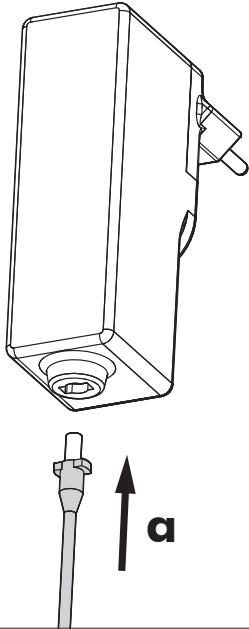

3

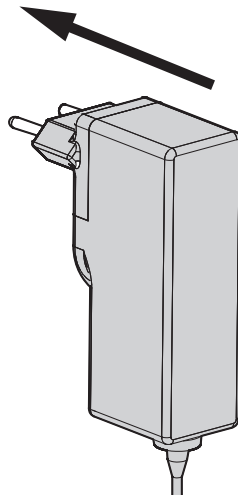
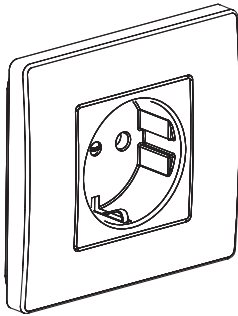

4

⏻ **On/Off**
⌚ **Dimmer**

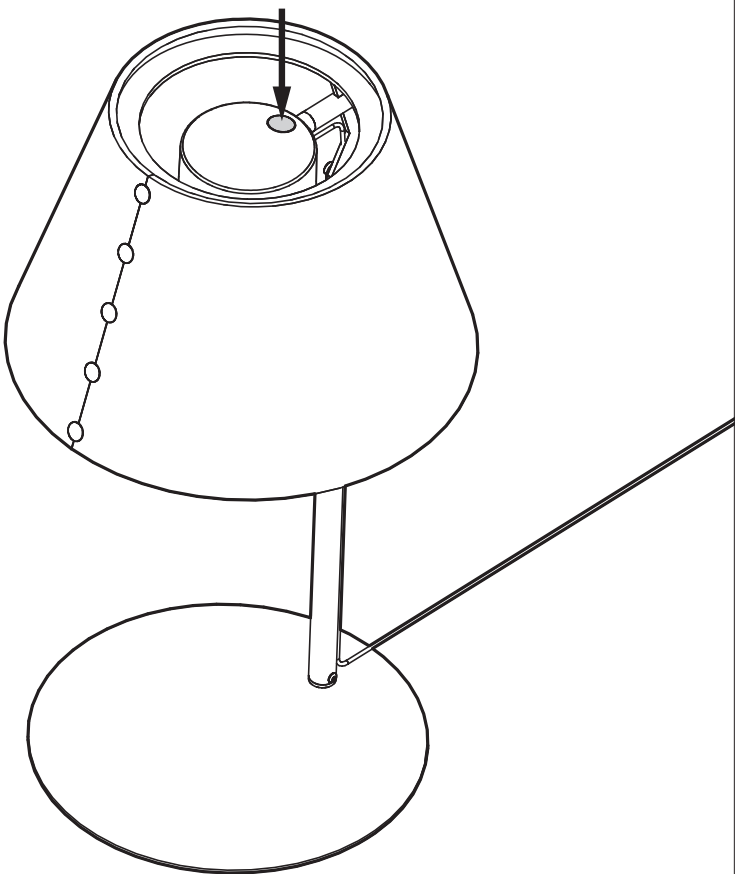

!

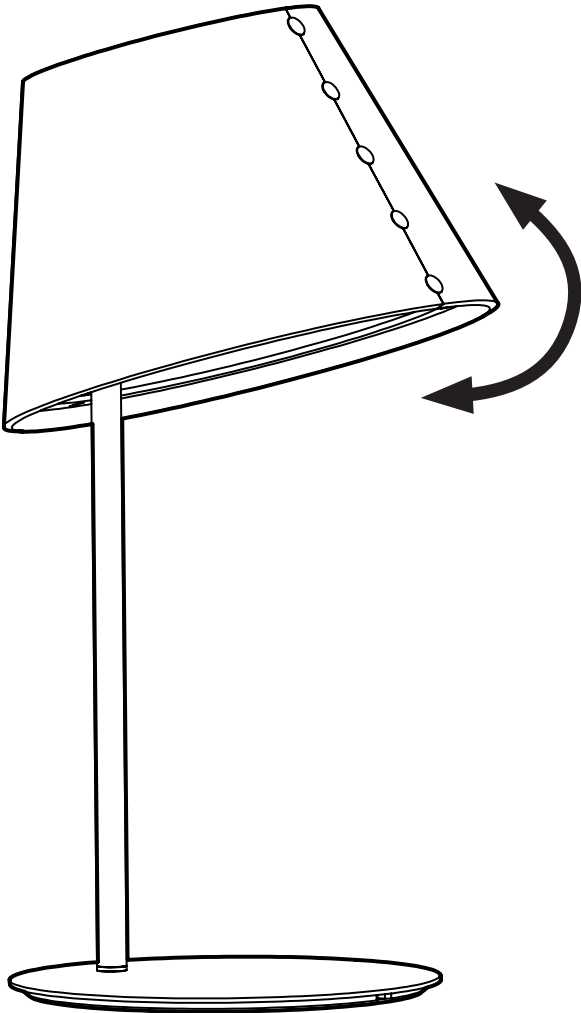

BuzziSpace Group NV
Italiëlei 8, 2000 Antwerp
Belgium

☎ +32 (0)3 846 10 00

✉ info@buzzi.space

🌐 www.buzzi.space



A-0000007332/02
Last update: 01/12/2023