

# BuzziHat

INSTALLATION MANUAL

NOTICE D'EMPLOI

120V-277V

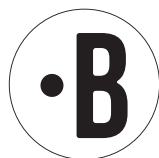
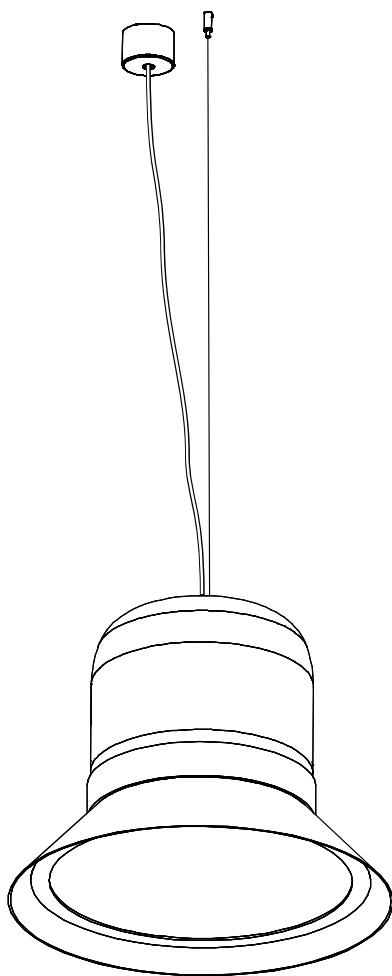

## Technical info

---

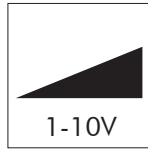
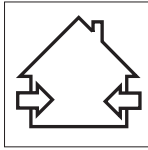

**⚠** The light source of this luminaire is not replaceable; when the light source reaches its end of life the whole luminaire shall be replaced.

**⚠** La source lumineuse de ce luminaire n'est pas remplaçable ; quand la source lumineuse atteint sa fin de vie, l'ensemble luminaire doit être remplacé.

## Excluded

---

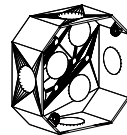
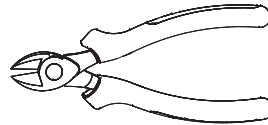
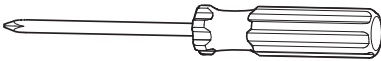
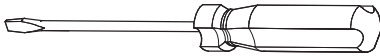

## Included BuzziHat

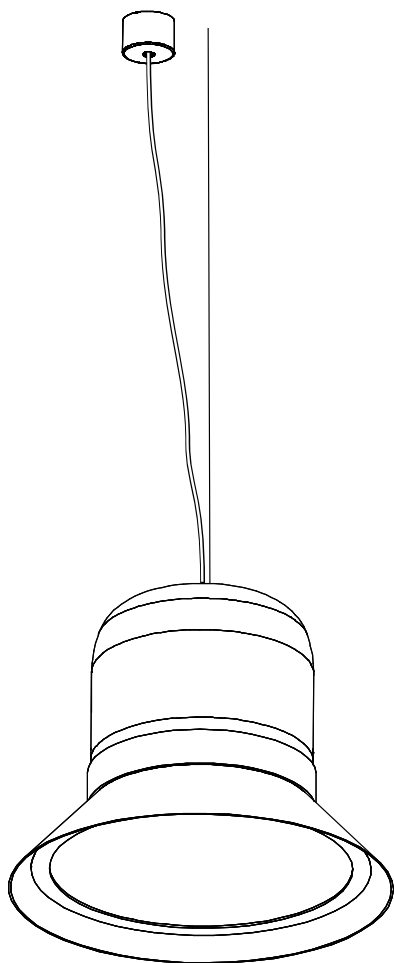
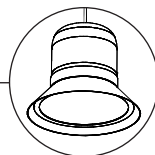

3x

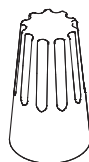

2x

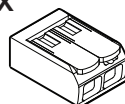

For dimmable function  
Pour fonction gradable

1x

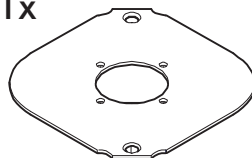

M6

1x



1x



# BuzziHat

2 PERS. 

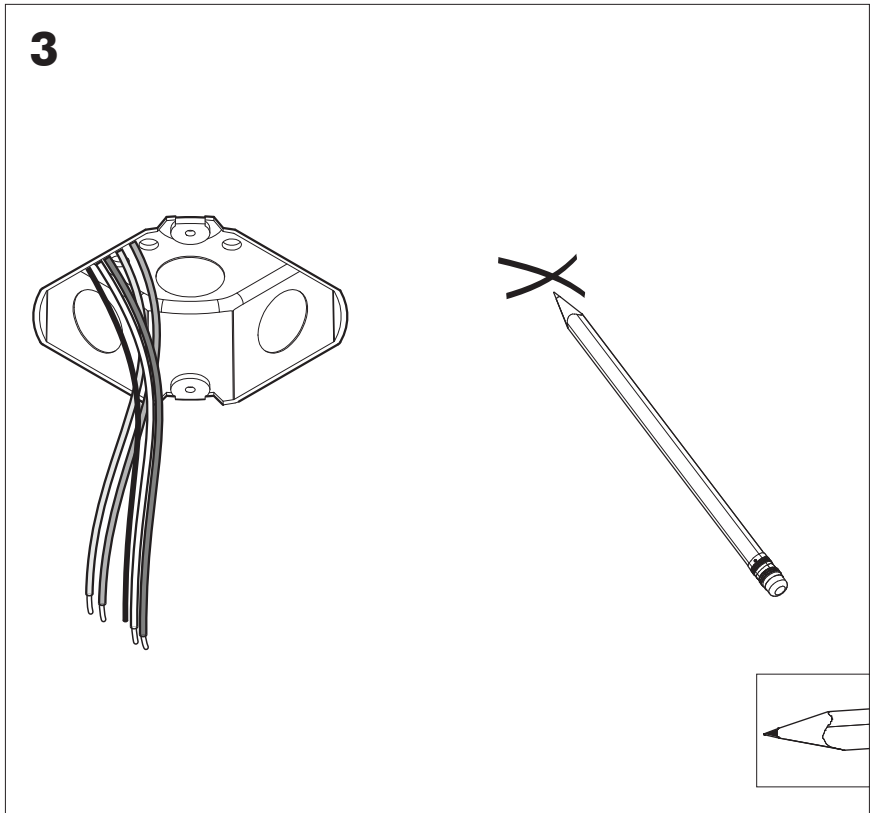
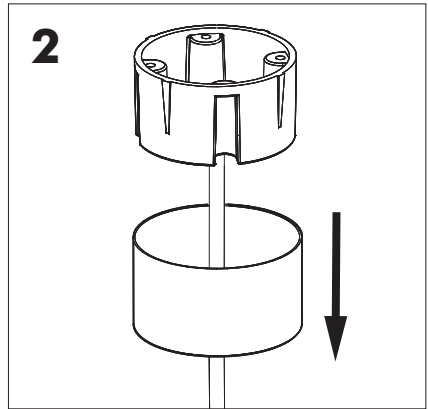
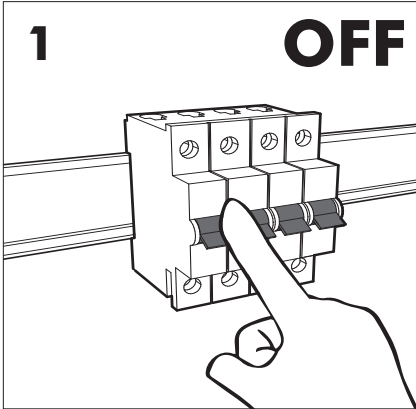
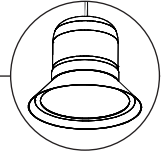

**4**

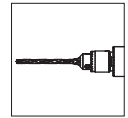
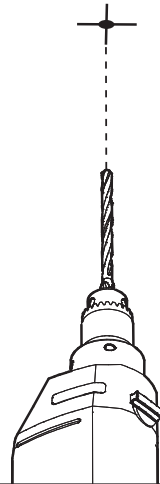
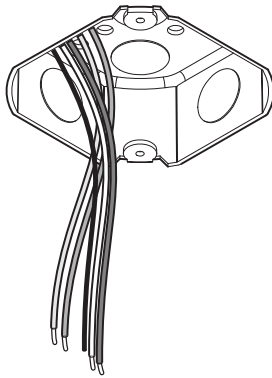

**5**

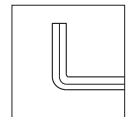
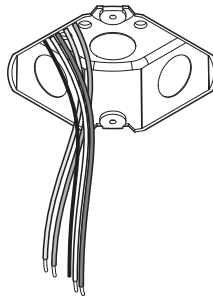

6

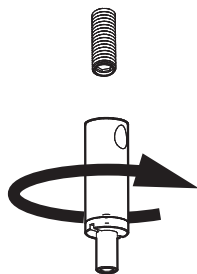
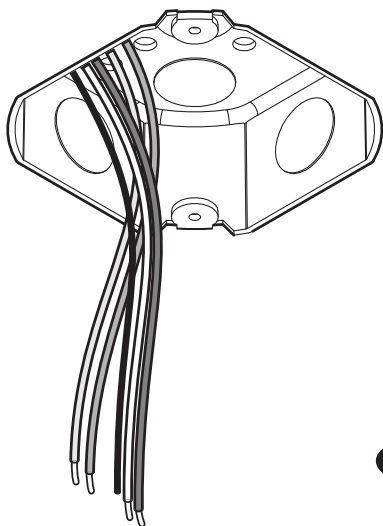

7

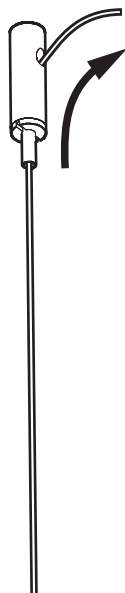
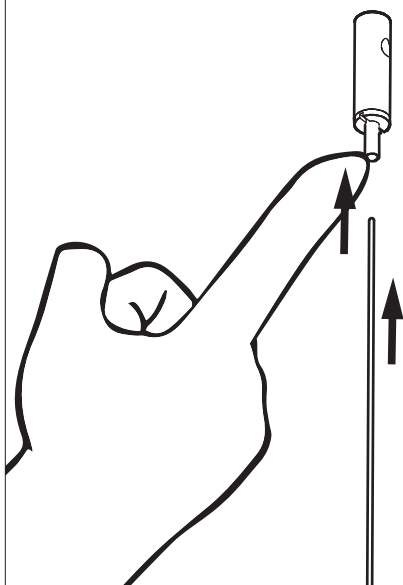

8a

Connection including dimmable function  
Raccordement avec fonction de gradation

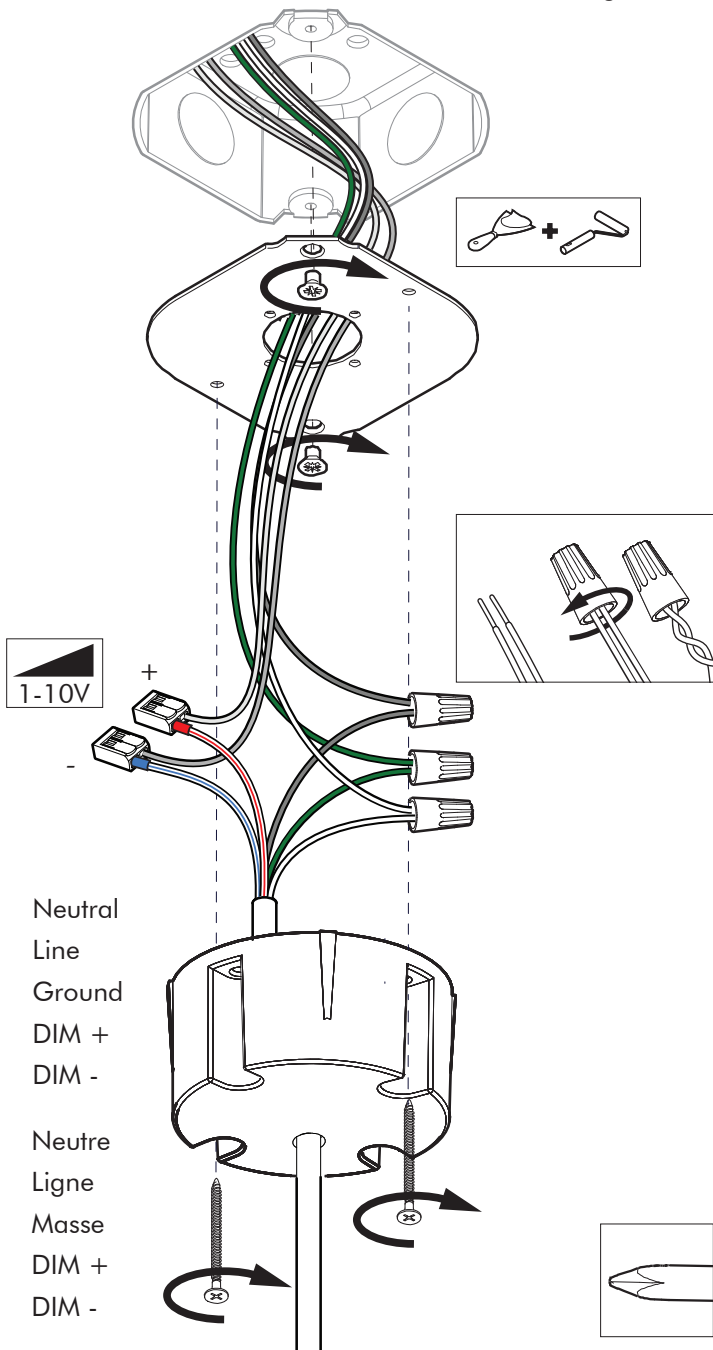

# 8b

## Connection excluding dimmable function Raccordement sans fonction de gradation

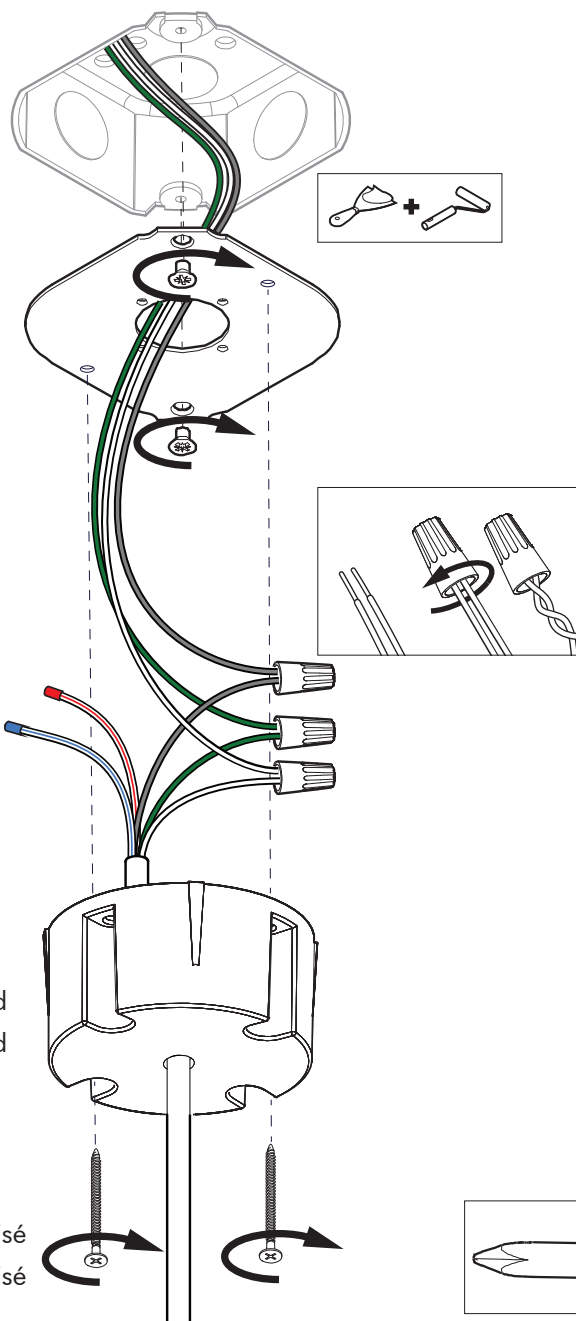

- |       |             |
|-------|-------------|
| White | Neutral     |
| Black | Line        |
| Green | Ground      |
| Red   | Not used    |
| Blue  | Not used    |
| Blanc | Neutre      |
| Noir  | Ligne       |
| Vert  | Masse       |
| Rouge | Non utilisé |
| Bleu  | Non utilisé |



9

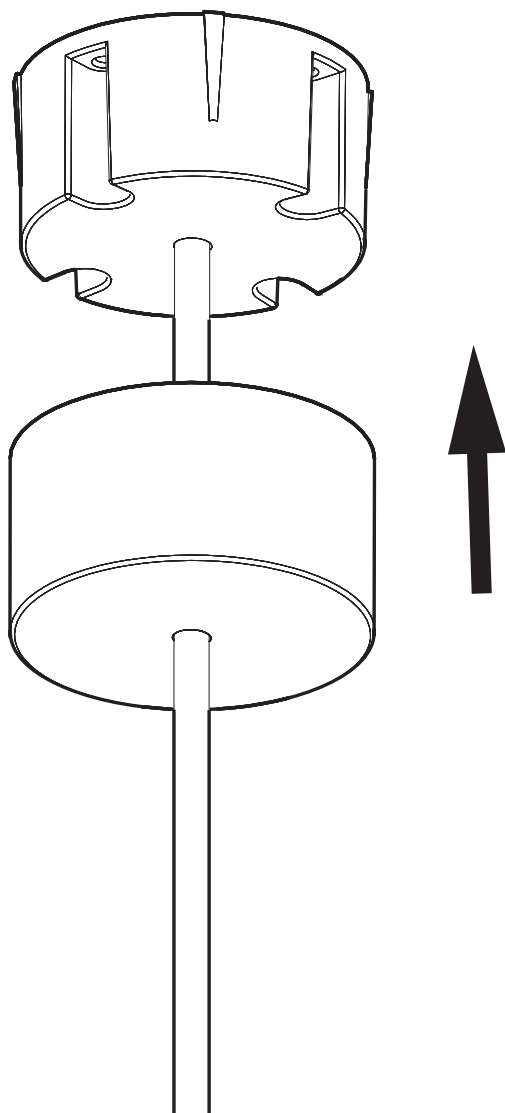

!

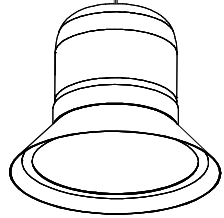
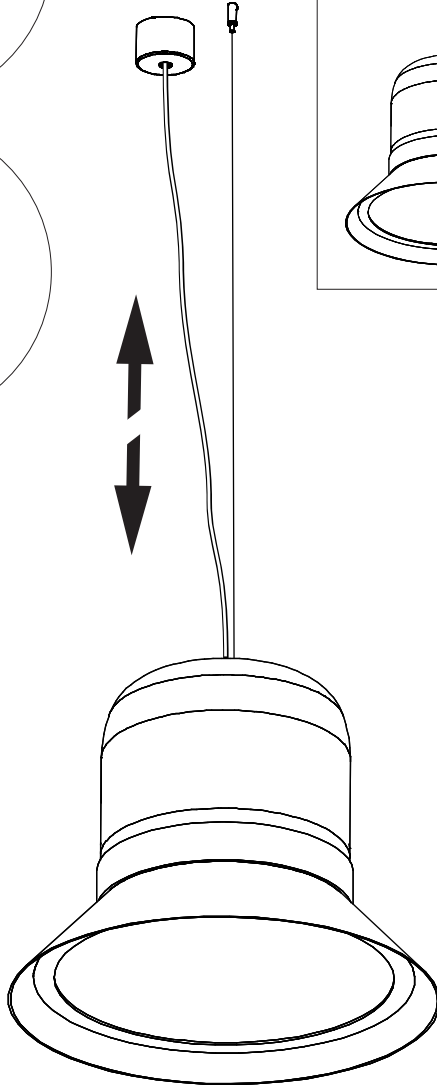
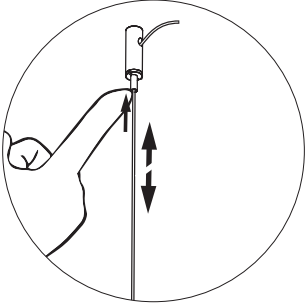
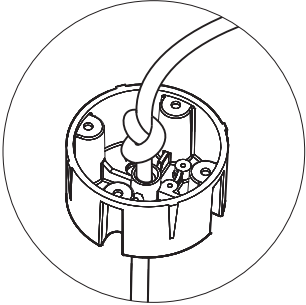



BuzziSpace Group NV  
Italiëlei 8, 2000 Antwerp  
Belgium

☎ +32 (0)3 846 10 00

✉ [info@buzzi.space](mailto:info@buzzi.space)

🌐 [www.buzzi.space](http://www.buzzi.space)



A-0000003389/04  
Last update: 01/12/2023