

BuzziProp LED

INSTALLATION MANUAL
220-240V

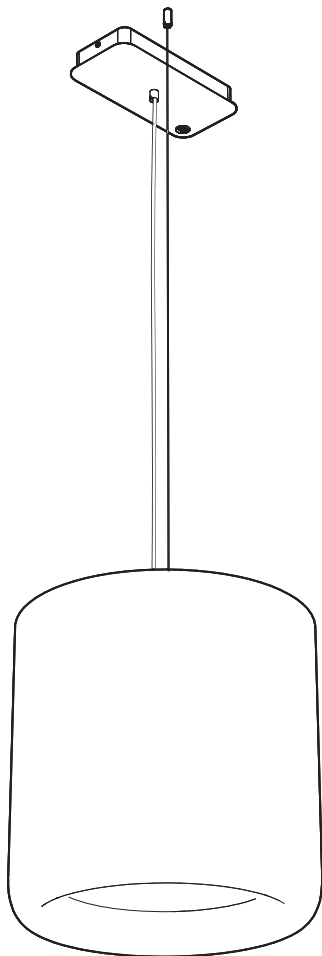

Technical info

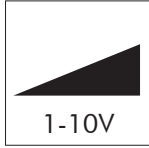
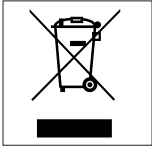
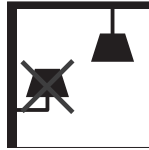
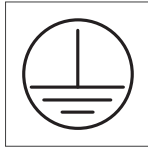
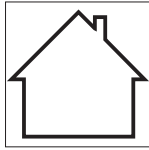

OR



Environmental Protection

Waste electrical products should not be disposed of with household waste. Please recycle where facilities exist. Check with your Local Authority or retailer for recycling advice.

⚠ The light source of this luminaire is not replaceable; when the light source reaches its end of life the whole luminaire shall be replaced.

Excluded

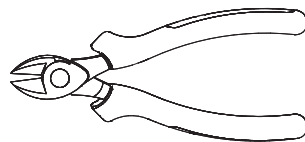
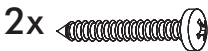
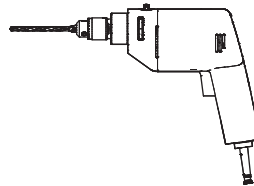
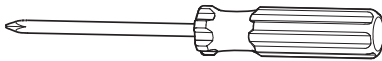
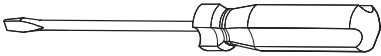

Included

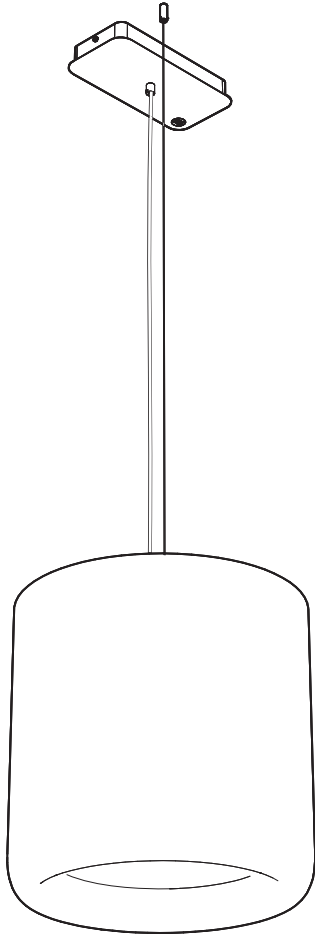

M6

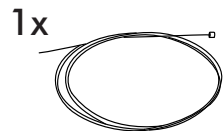
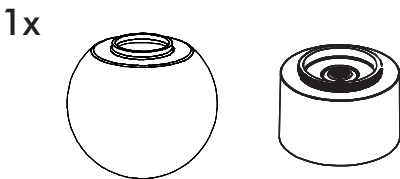
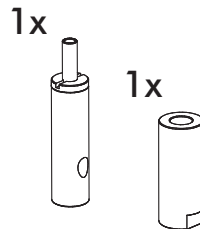
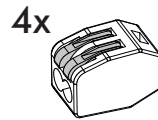
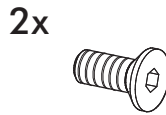
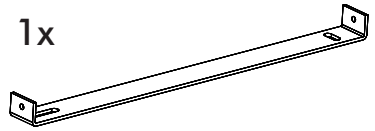

Globe or Spot

3

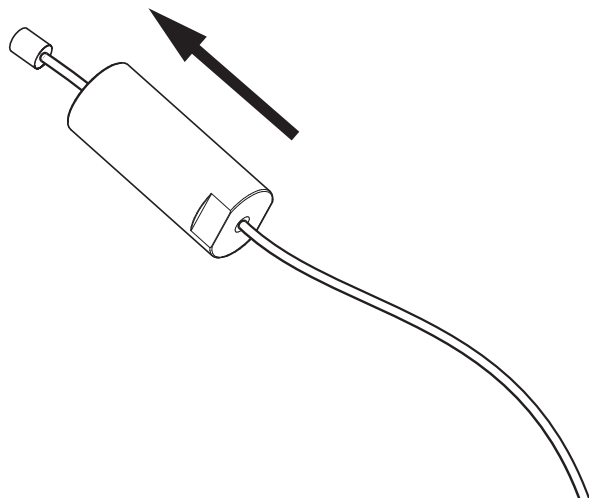
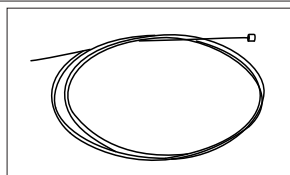

4

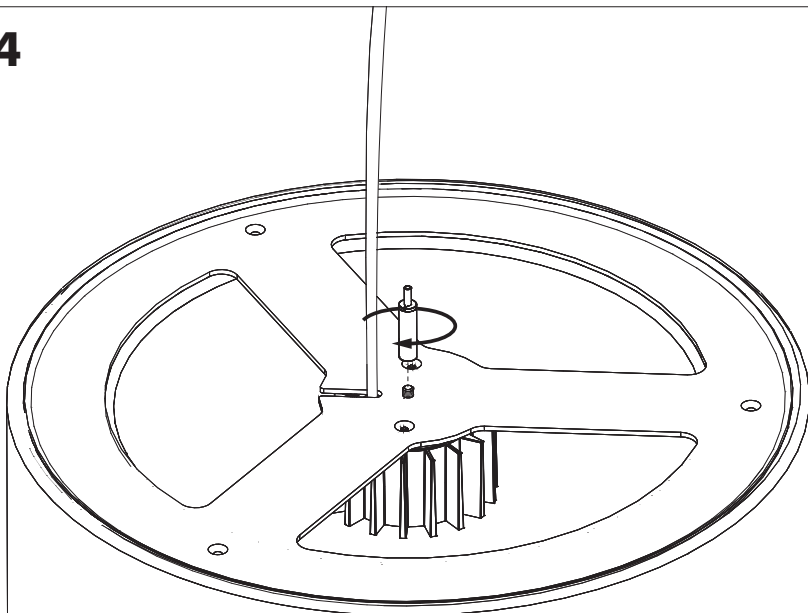

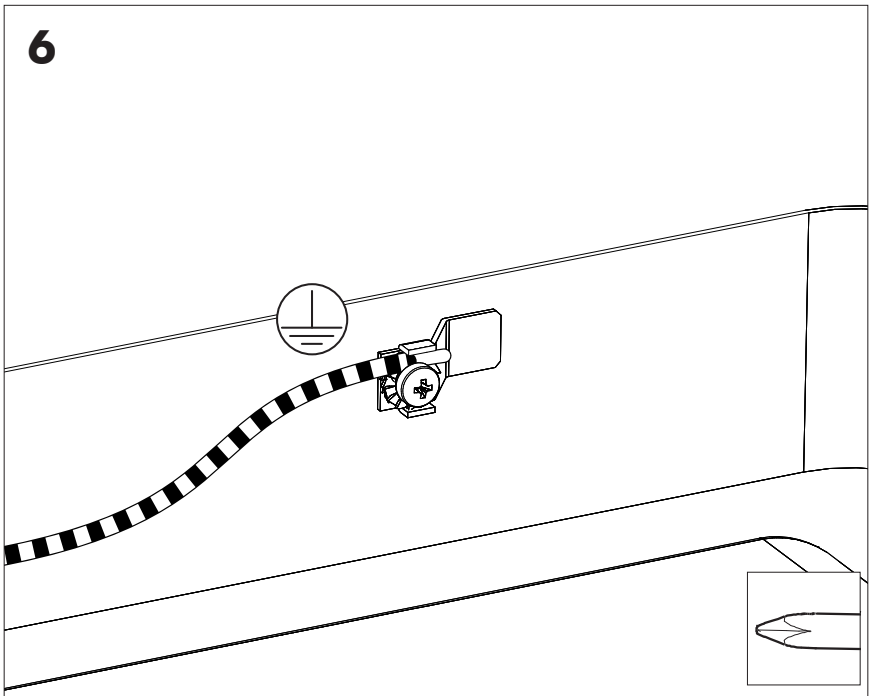
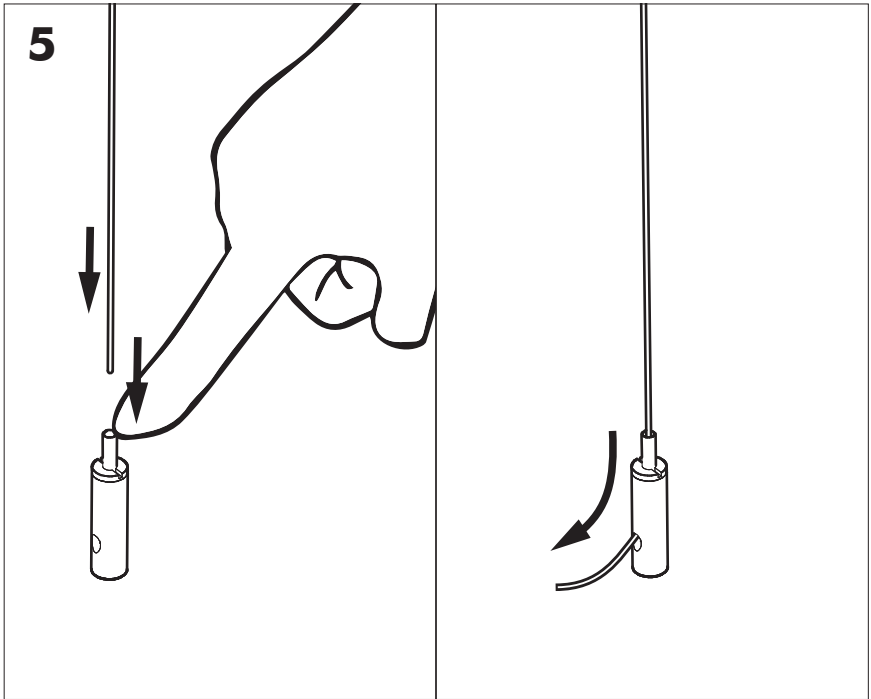

7a

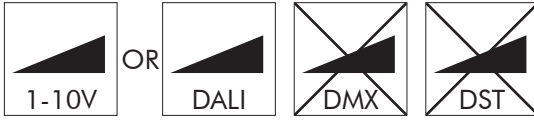

Connection including dimmable function

Dim+
Dim-

- Blue Neutral
- Brown Line
- Red DIM +
- Black DIM -

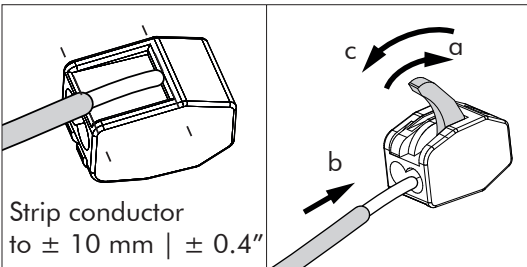

7b Connection excluding dimmable function

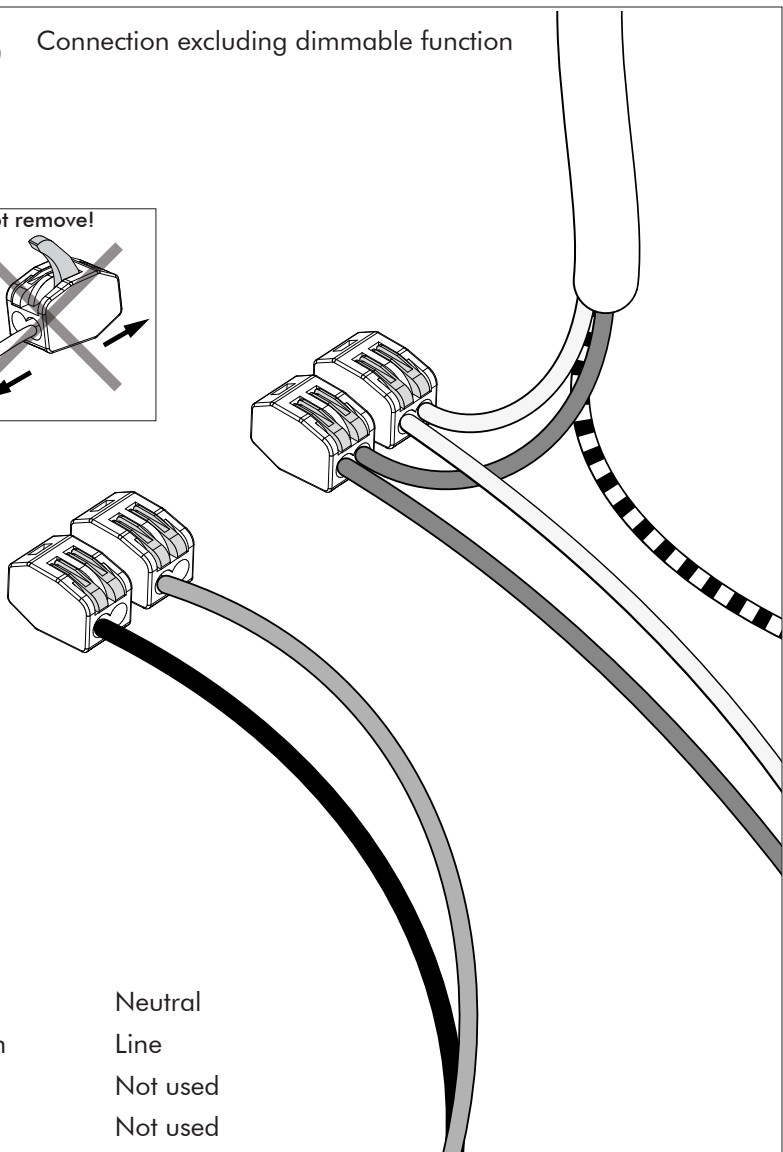
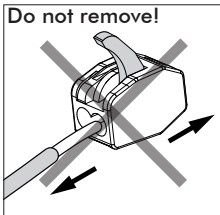

Blue	Neutral
Brown	Line
Red	Not used
Black	Not used

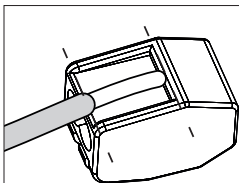

Strip conductor to ± 10 mm

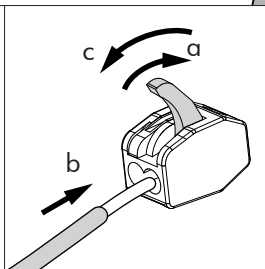

8

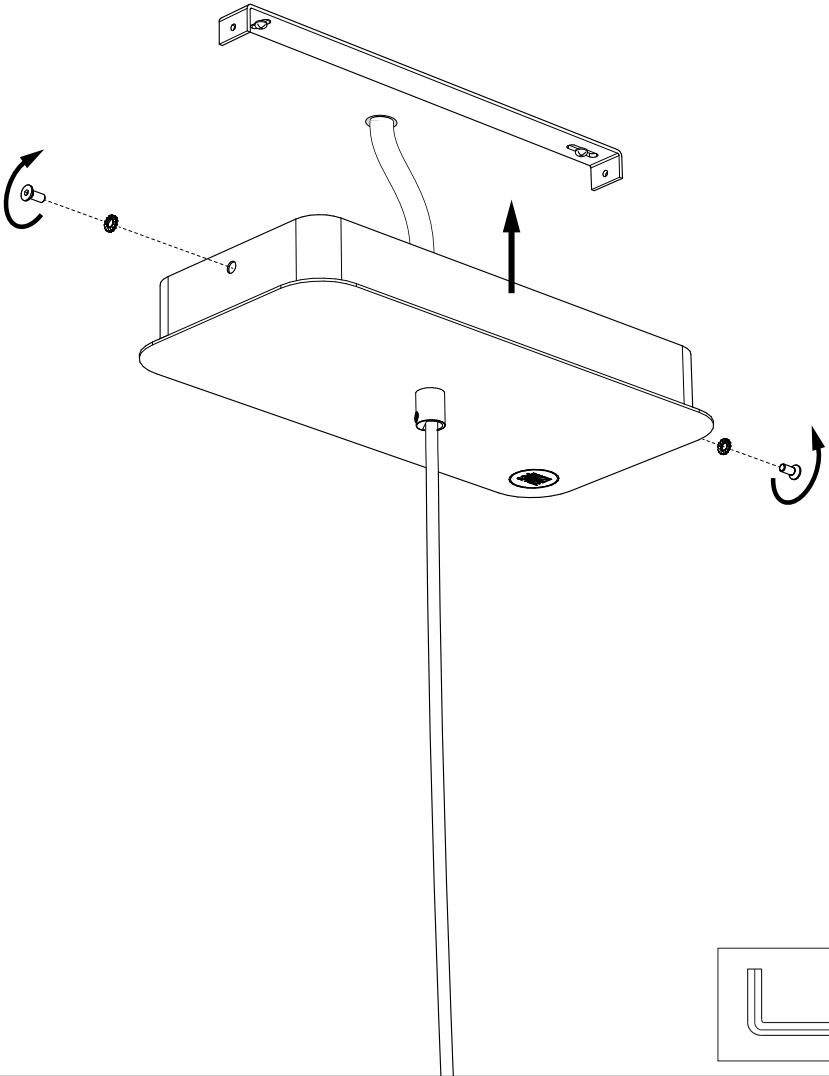

9

9 Globe

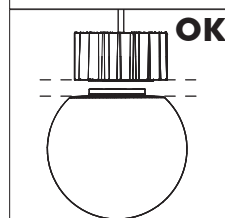
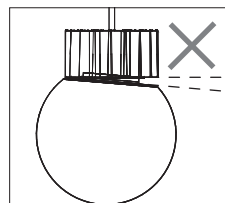
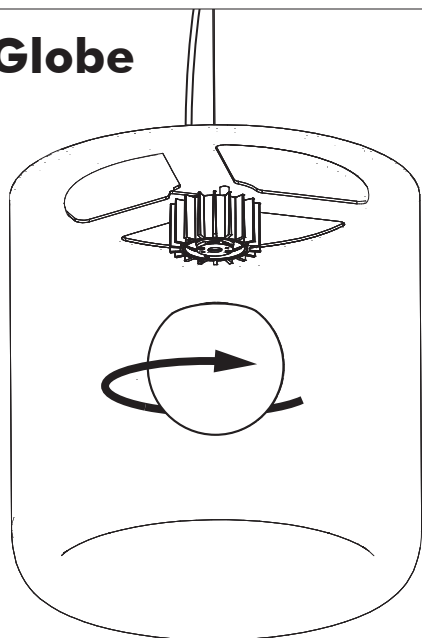

Spot

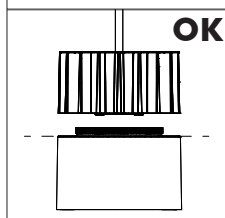
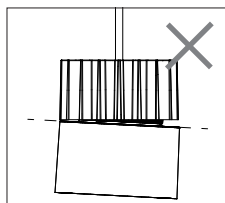
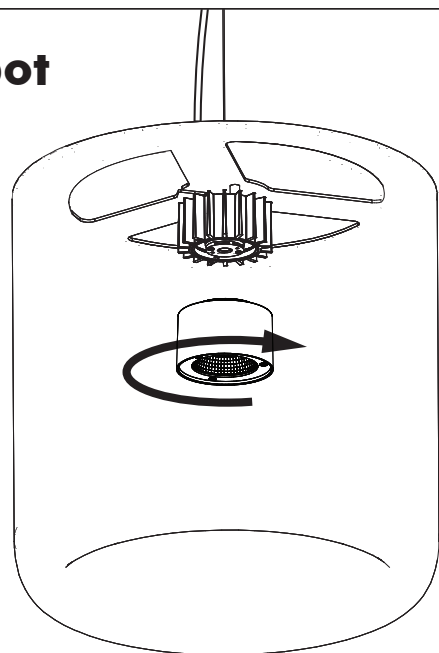

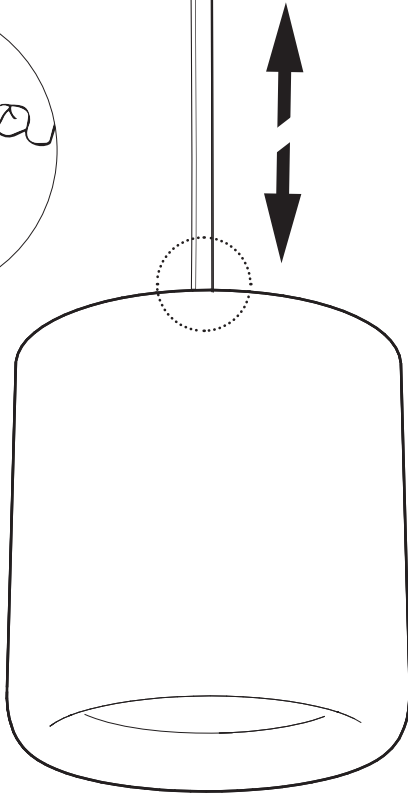
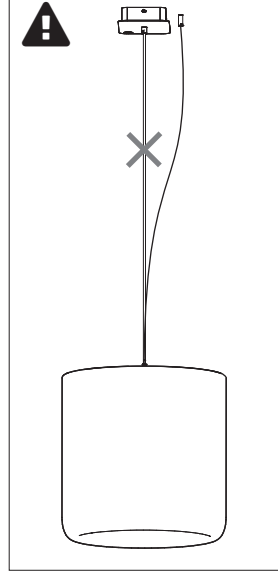
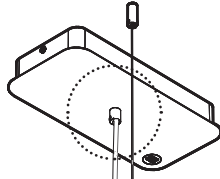
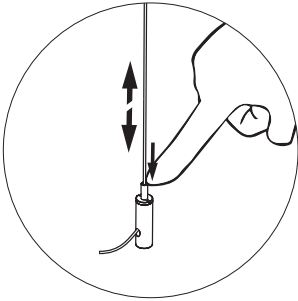
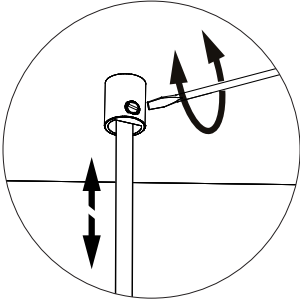

BuzziSpace Group NV
Italiëlei 8, 2000 Antwerp
Belgium

☎ +32 (0)3 846 10 00

✉ info@buzzi.space

🌐 www.buzzi.space



A-0000003377/05
Last update: 04/12/2023