

BuzziProp LED

INSTALLATION MANUAL

MODE DE L'EMPLOI

100V-240V/277V

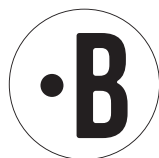
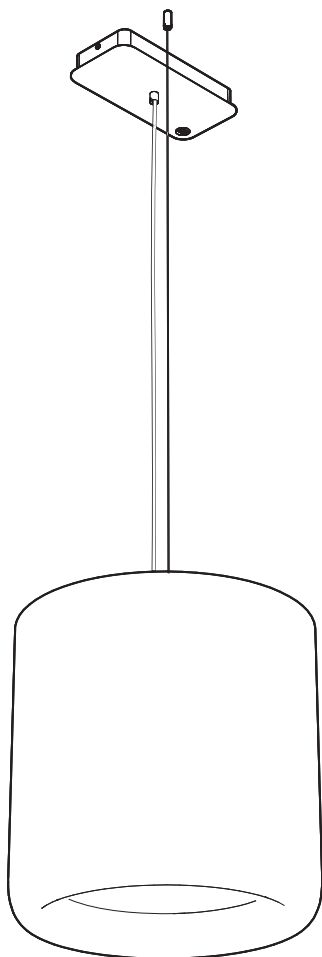

Technical info

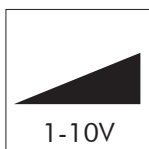
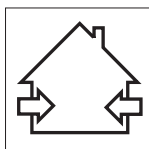

⚠ The light source of this luminaire is not replaceable; when the light source reaches its end of life the whole luminaire shall be replaced.

Excluded

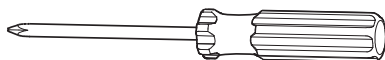
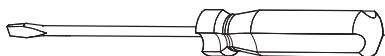

2x 

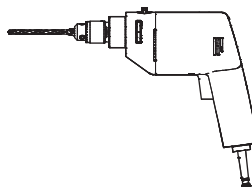
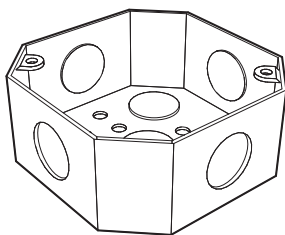

1x 

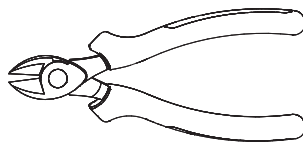

Included

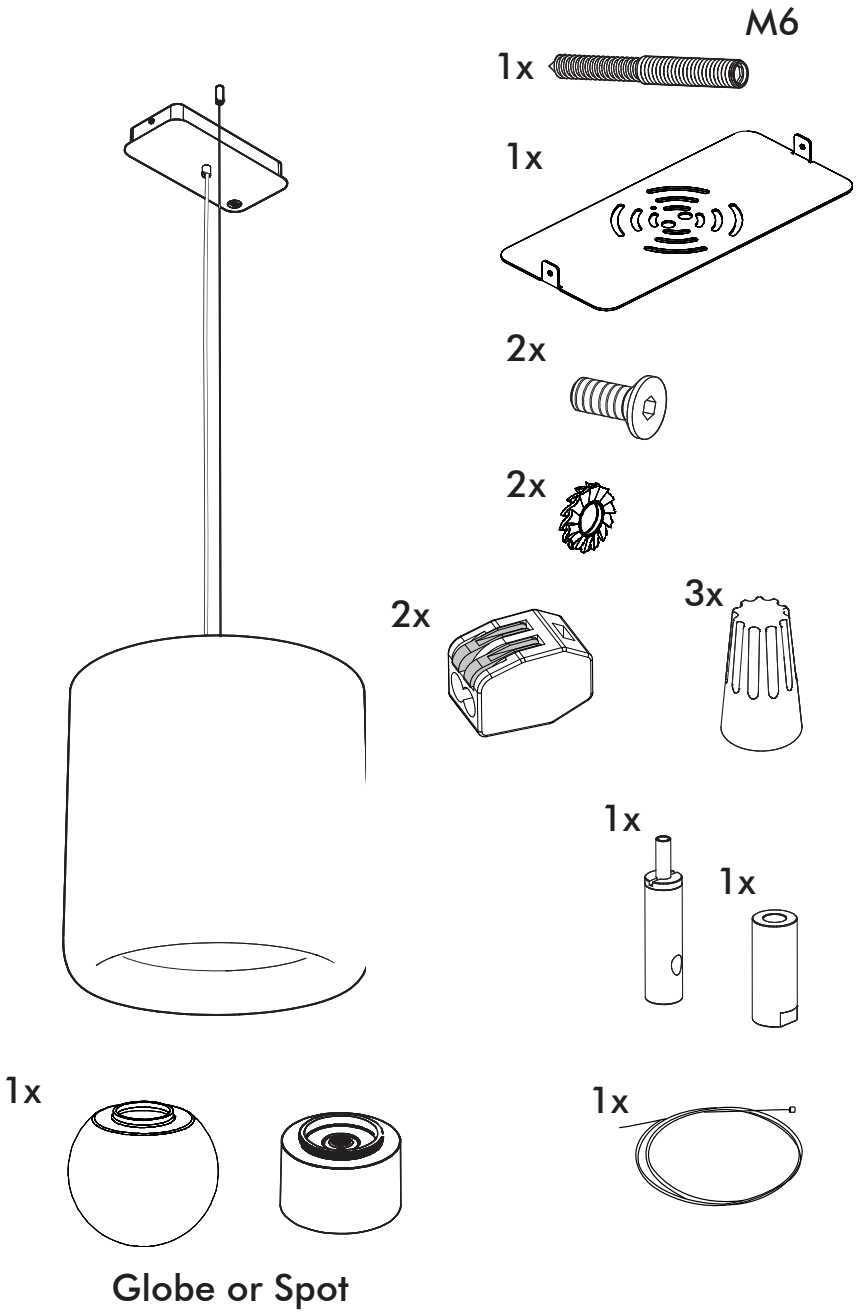

BuzziProp LED

2 PERS. 

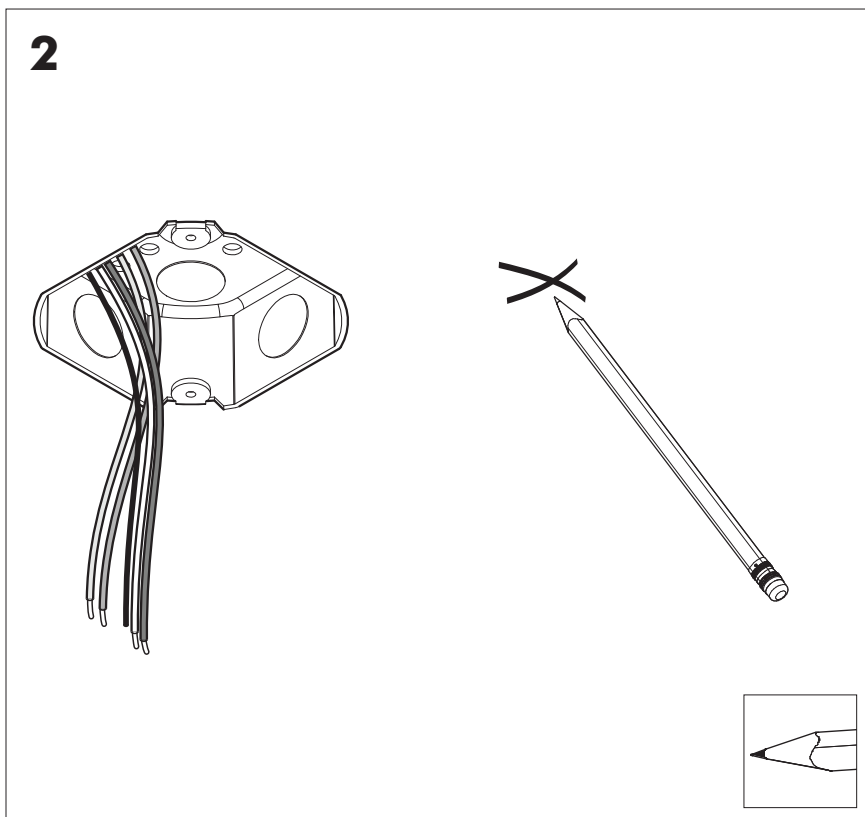
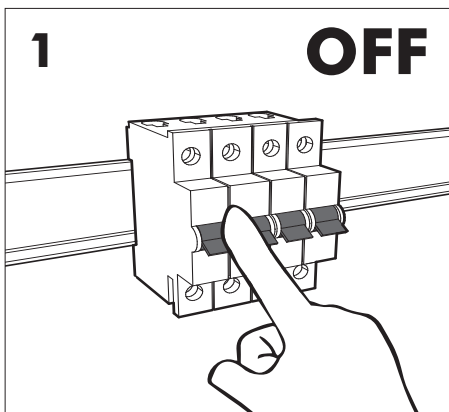
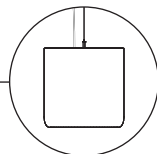

3

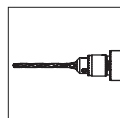
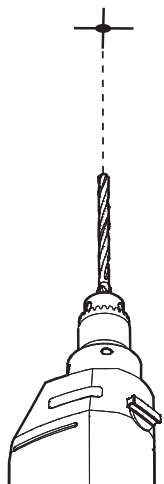
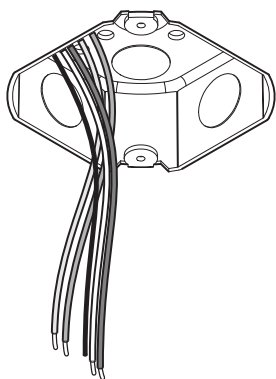

4

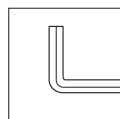
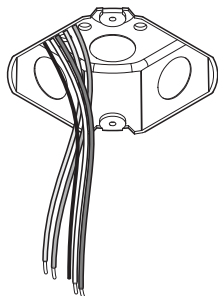

5

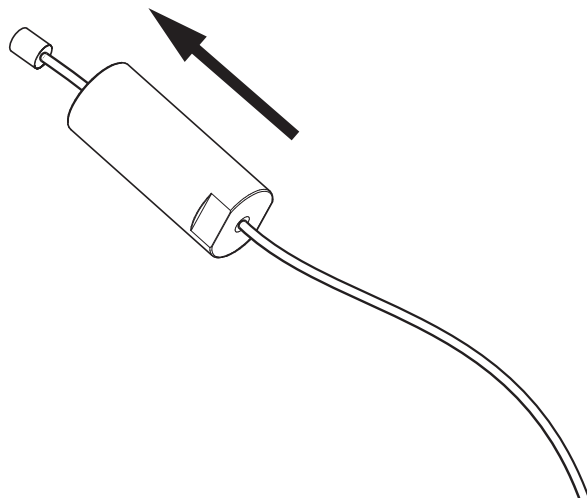
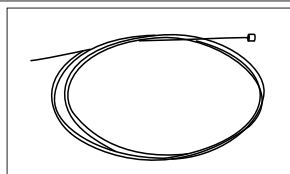

6

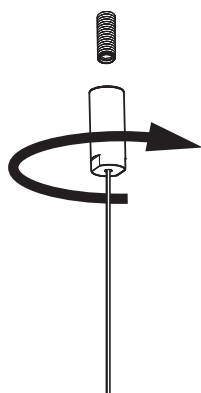
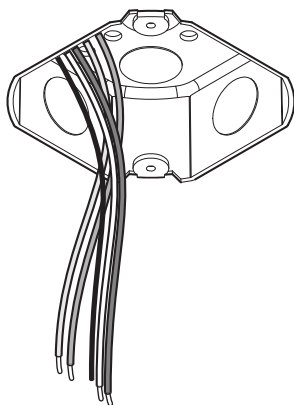

7

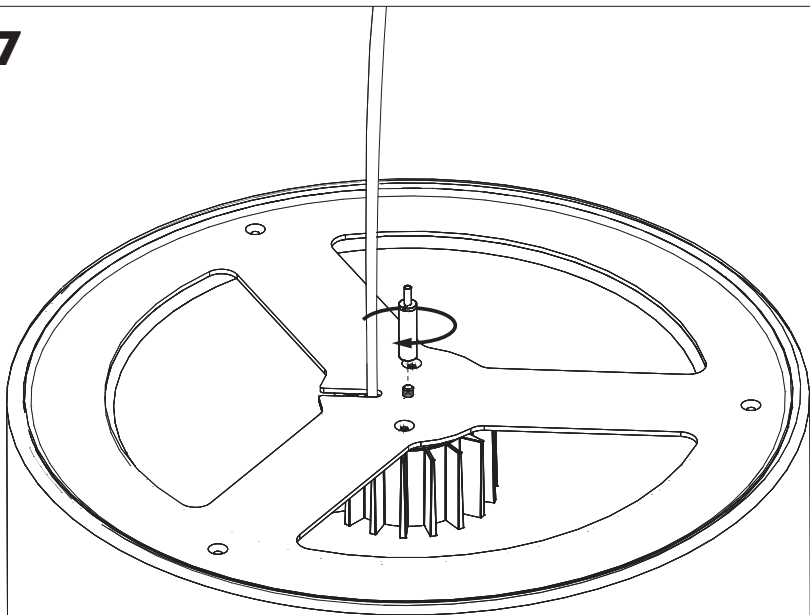

8

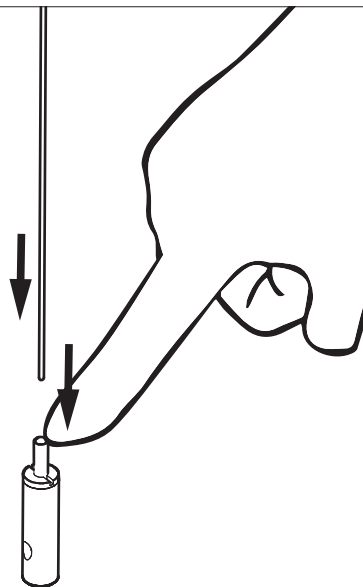

9a

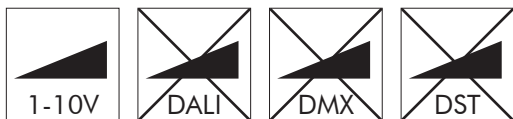

Connection including dimmable function

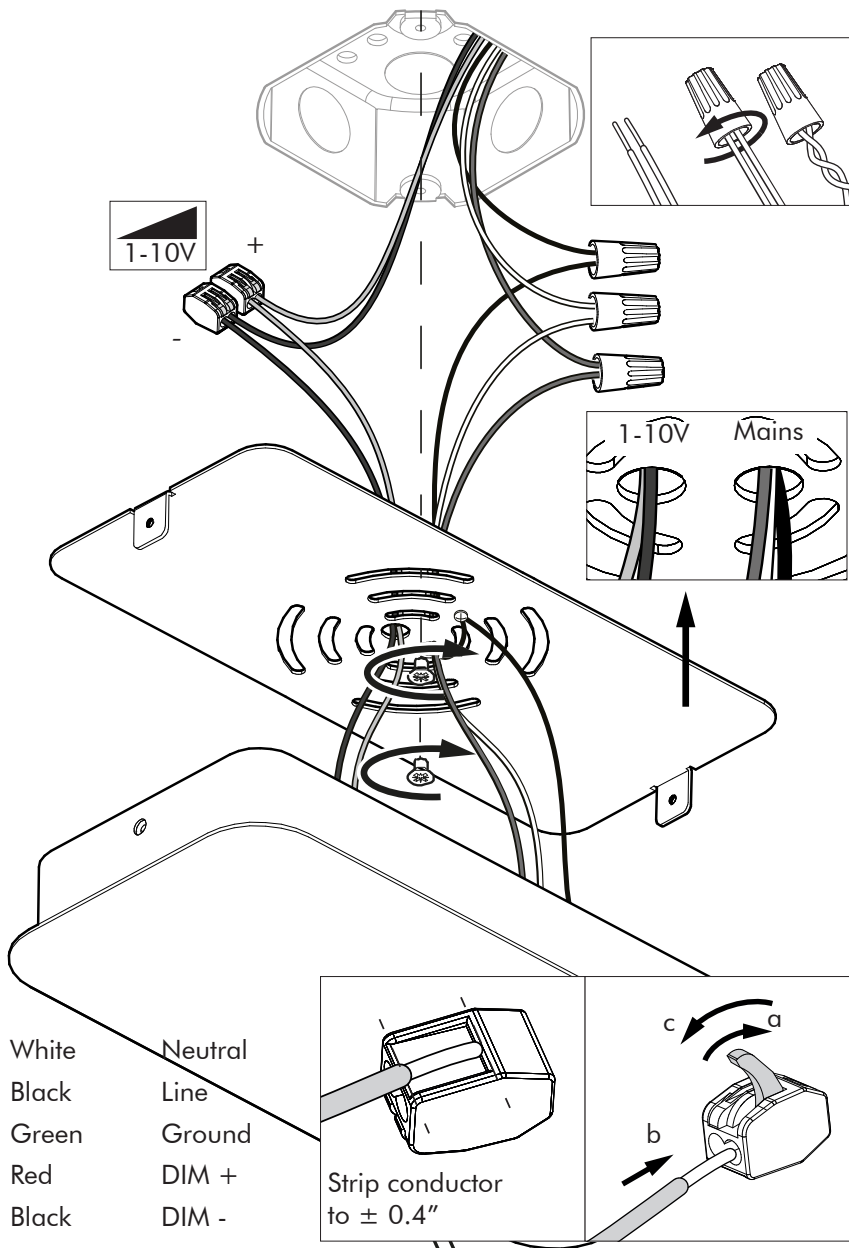

9b

Connection excluding dimmable function

Do not remove!

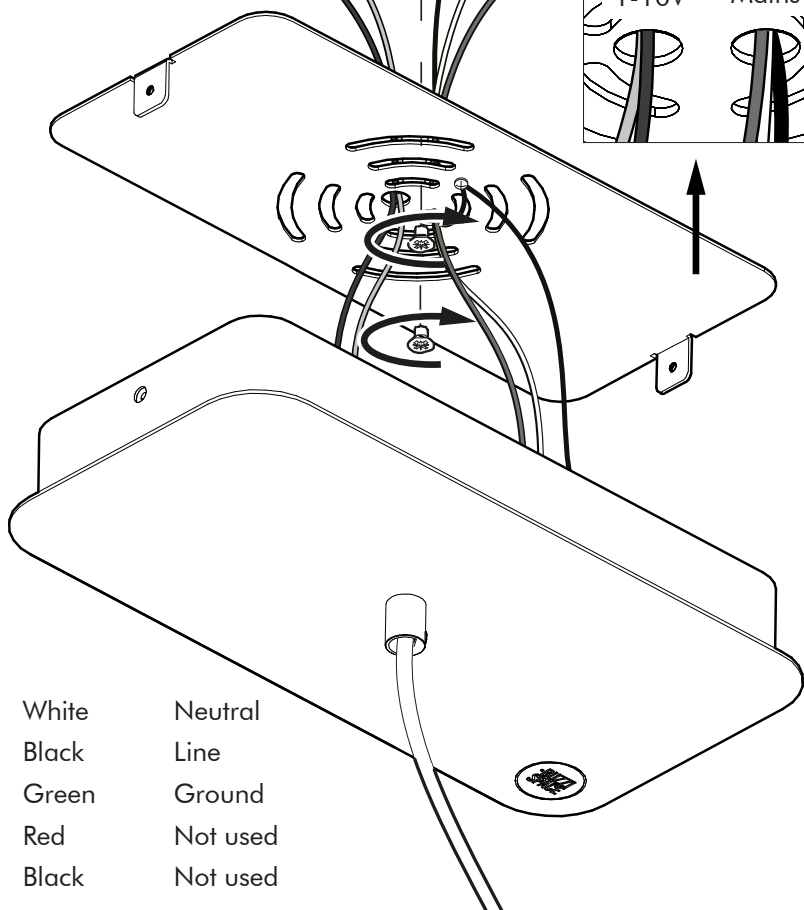
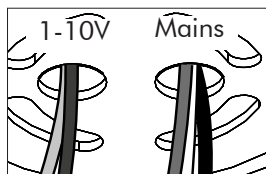
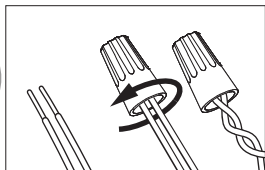
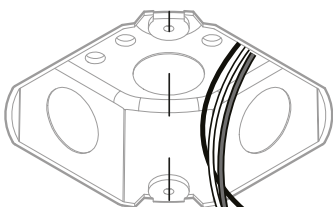
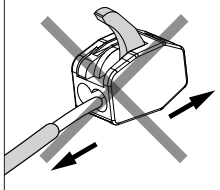

White	Neutral
Black	Line
Green	Ground
Red	Not used
Black	Not used

10

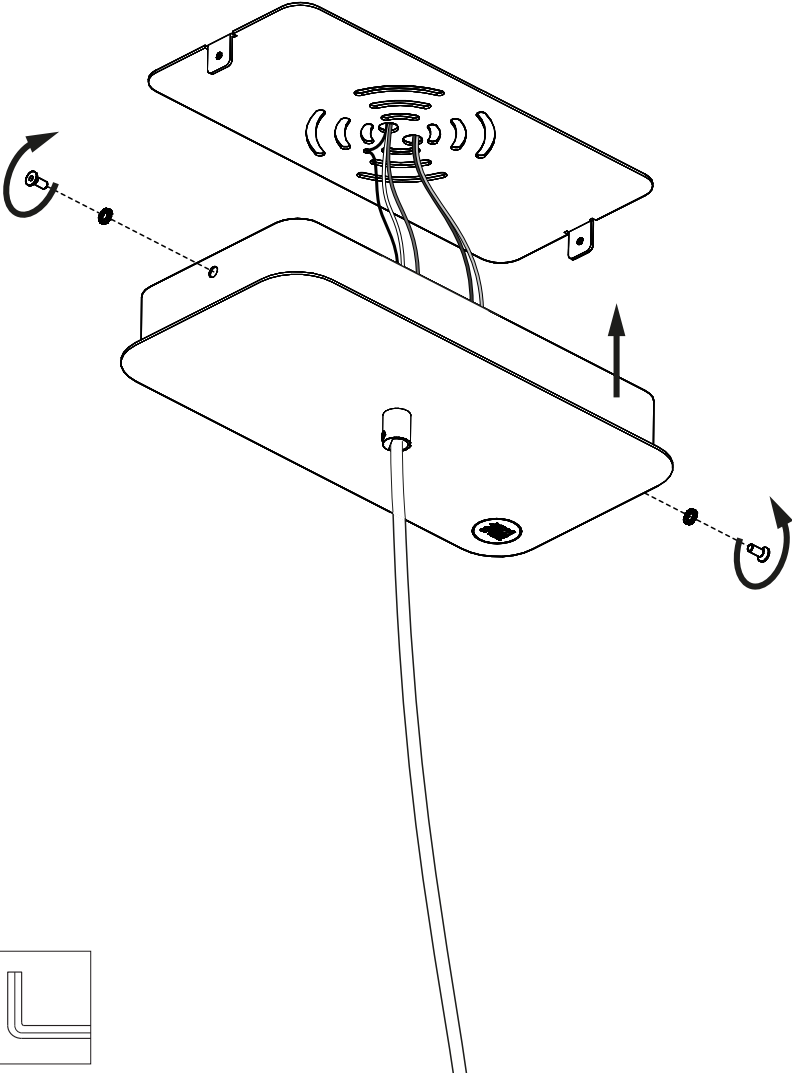

11 Globe

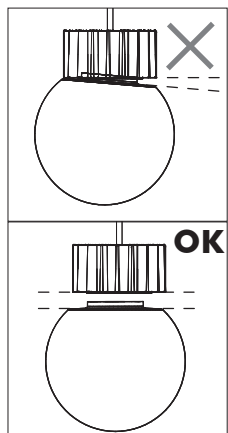
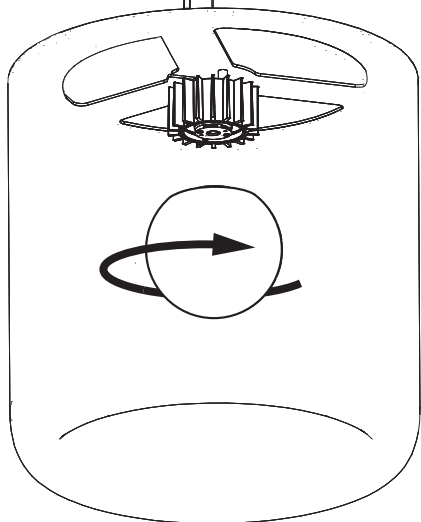

Spot

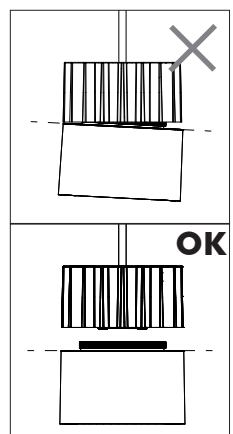
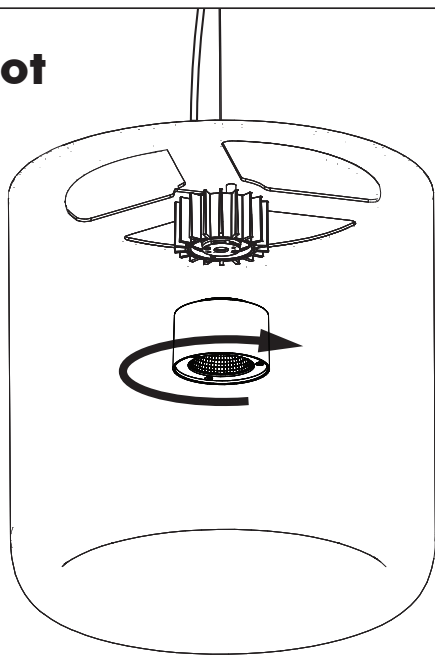

BuzziSpace Group NV
Italiëlei 8, 2000 Antwerp
Belgium

☎ +32 (0)3 846 10 00

✉ info@buzzi.space

🌐 www.buzzi.space



A-0000003378/06
Last update: 04/12/2023