



Product Specification Sheet

BuzziSol LED EU

— By BuzziSpace Studio

Shine bright

BuzziSol is a versatile and straightforward pendant light fixture that can be fitted with either a frosted glass globe for ambient setting or with a reflective spot for direct lighting. Stick to BuzziSol Solo for smaller settings or add a BuzziSol Trio or BuzziSol Quintet variation for larger gathering spots and collaboration areas. Because of BuzziSol's demure design language, it can work on its own to create modern and minimalist spaces. Or pair it with some of our acoustic lighting solutions such as BuzziPleat, BuzziShade, BuzziProp Small, BuzziProp Beam, and BuzziZepp.

The Family

LED Sol Solo Globe

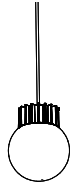

LED Sol Solo Spot



LED Sol Trio Globe

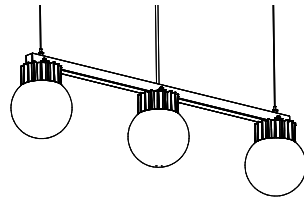

LED Sol Trio Spot

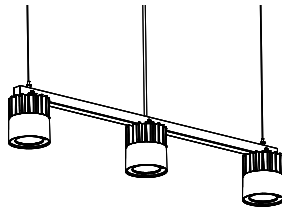

Led Sol Quintet Globe

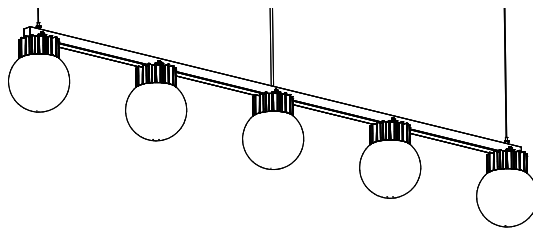

LED Sol Quintet Spot

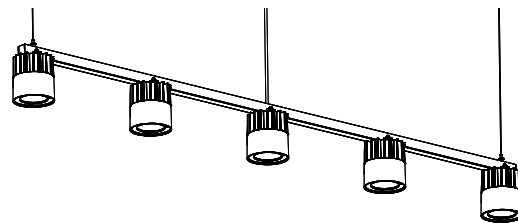

Lighting Units

Required order information

1. Model
2. Light Option
3. Mounting Option (only for Trio and Quintet)

Lighting Data

Lighting Units

BuzziSol Globe



BuzziSol collection are suspended LED fixtures consisting of 1, 3 or 5 powder-coated black heatsinks with LED chip on board (COB) light sources.

The product can be finished with a frosted glass globe diffuser which spreads the light in a large beam angle of 170°, enlighting the surroundings or reflector spot adaptors directing the light with a beam angle of 38° downwards.

Spot



BuzziSol

Model: Solo

Lighting Options			Characteristics			Mounting	
Lighting Unit	Voltage Input	Color Temperature	UGR (Diffuser type)	Dimming	Technical	Visual Options	
LED Solo	220 - 240V	3000K	23 (Globe)	1-10V DALI	Power consumption: 20W Light output: 1500 Lm Efficacy: 75 Lm/W CRI: > 90	Color: Power Cable: Black Ceiling Canopy: Black	1 cable of 2 or 5 m Alu or Black
			12 (Spot)	1-10V DALI	Power consumption: 20W Light output: 1500 Lm Efficacy: 75 Lm/W CRI: >w 90		

Model: Trio

Lighting Options			Characteristics			Mounting	
Lighting Unit	Voltage Input	Color Temperature	UGR (Diffuser type)	Dimming	Technical	Visual Options	
LED Trio	220 - 240V	3000K	23 (Globe)	1-10V	Power consumption: 51W Light output: 3 x1500 Lm Efficacy: 88 Lm/W CRI: > 90	Color: Power Cable: Black Ceiling Canopy: Black	2 cables of 2 or 5m Alu or Black
			12 (Spot)	1-10V	Power consumption: 51W Light output: 3 x1500 Lm Efficacy: 88 Lm/W CRI: > 90		

Model: Quintet

Lighting Options			Characteristics			Mounting	
Lighting Unit	Voltage Input	Color Temperature	UGR (Diffuser type)	Dimming	Technical	Visual Options	
LED Quintet	220 - 240V	3000K	23 (Globe)	1-10V	Power consumption: 89W Light output: 5 x 1500 Lm Efficacy: 84 Lm/W CRI: > 90	Color: Power Cable: Black Ceiling Canopy: Black	2 cables of 2 or 5 m Alu or Black
			12 (Spot)	1-10V	Power consumption: 89W Light output: 5 x 1500 Lm Efficacy: 84 Lm/W CRI: > 90		

CE CB

Photometric Data

BuzziSol Solo

Sol Solo Globe Cartesian diagram

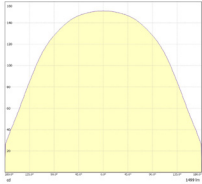

Sol Solo Globe Polar curve

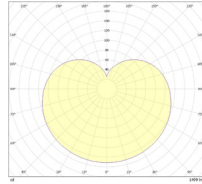

Sol Solo Spot Cartesian diagram

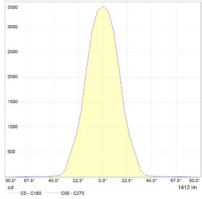

Sol Solo Spot Polar curve

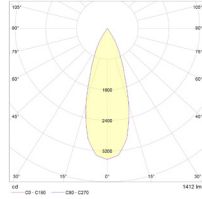

BuzziSol Trio

Sol Trio Globe Cartesian diagram

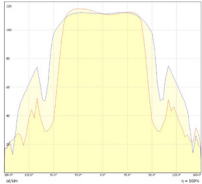

Sol Trio Globe Polar curve

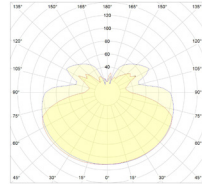

Sol Trio Spot Cartesian diagram

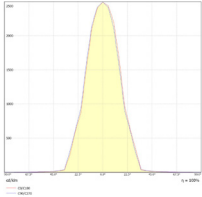

Sol Trio Spot Polar curve

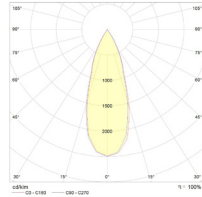

BuzziSol Quintet

Sol Quintet Globe Cartesian diagram

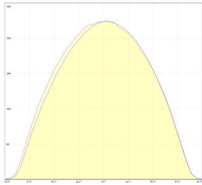

Sol Quintet Globe Polar curve

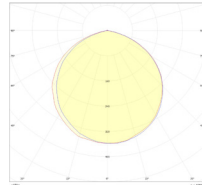

Sol Quintet Spot Cartesian diagram

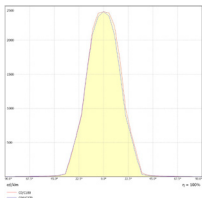

Sol Quintet Spot Polar curve

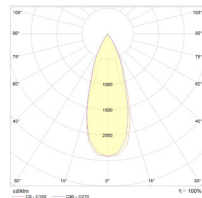

Tips and Tricks - Light Options

To enlighten your workplace with optimal lux levels take following measurements into account:

BuzziChip Small BuzziSol Solo

Solo Spot

Office,
Meeting room

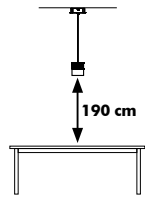

500 Lux

Solo Globe

Office,
Meeting room

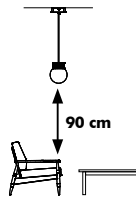

100 Lux

BuzziChip Medium BuzziSol Trio

Trio Spot

Office,
Meeting room

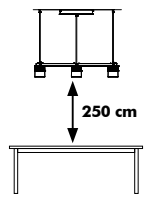

500 Lux

Trio Globe

Office,
Meeting room

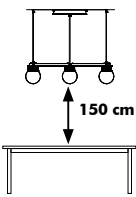

500 Lux

BuzziChip Large BuzziSol Quintet

Quintet Spot

Office
Meeting room

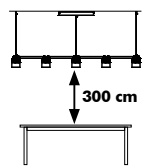

500 Lux

Quintet Globe

Office,
Meeting room

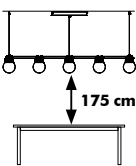

500 Lux

* According to EN12464

Product Data

Fixing System Lighting

BuzziSol Trio | Quintet

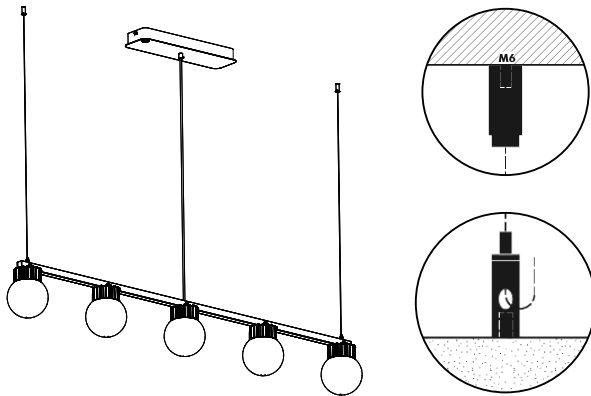

BuzziSol Trio | Quintet is suspended on 2 cables of 2 or 5 m black or alu colored cables, with fixing screw.

⚠ If installing on suspended ceiling, verify load capacity prior to installation.

Dimensions

BuzziSol Solo Globe

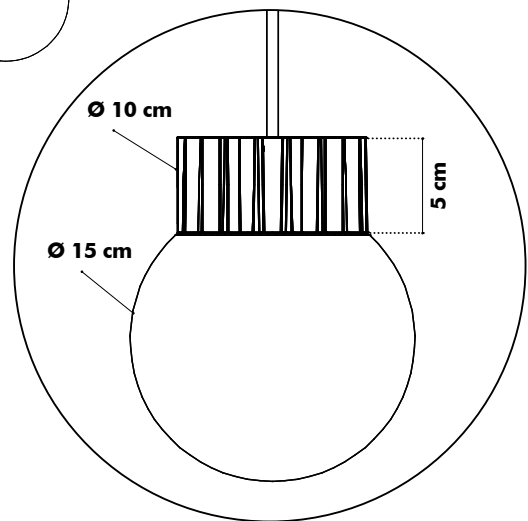
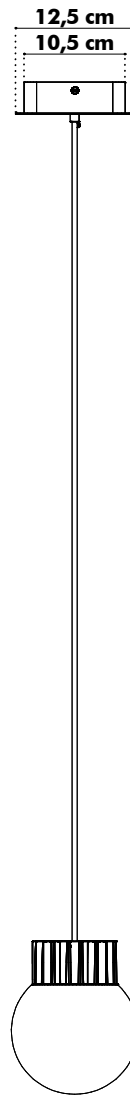
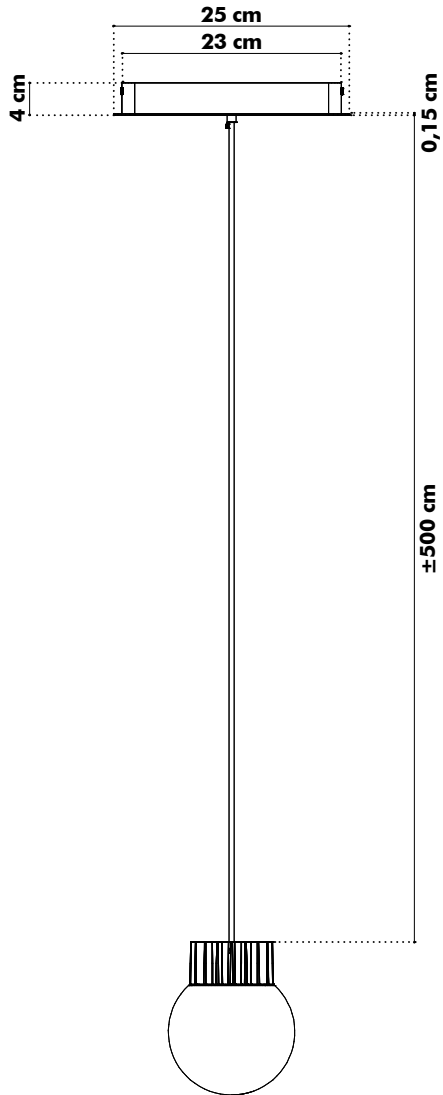

BuzziSol Solo Spot

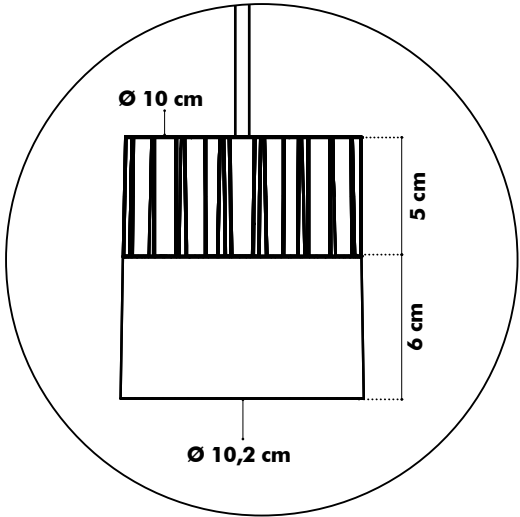
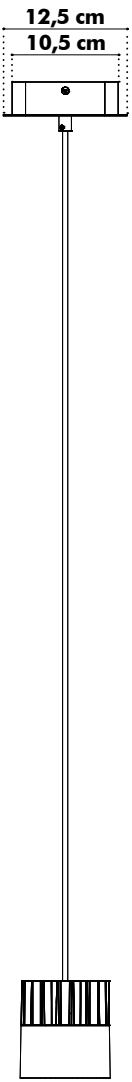
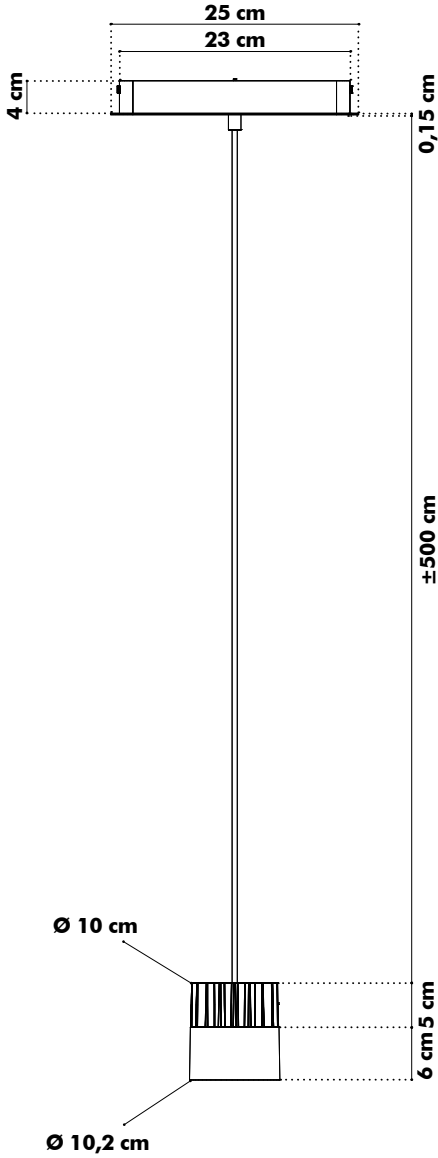

BuzziSol Trio Globe

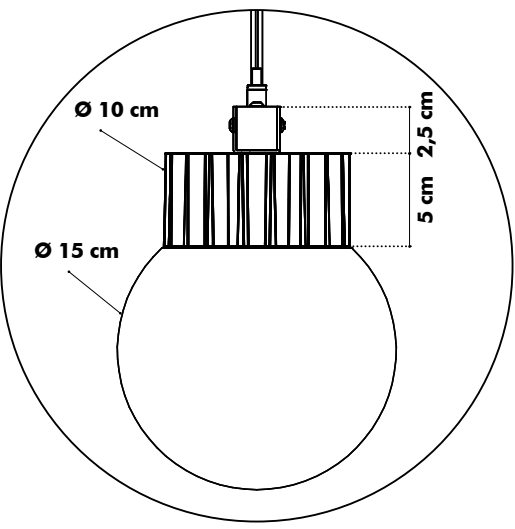
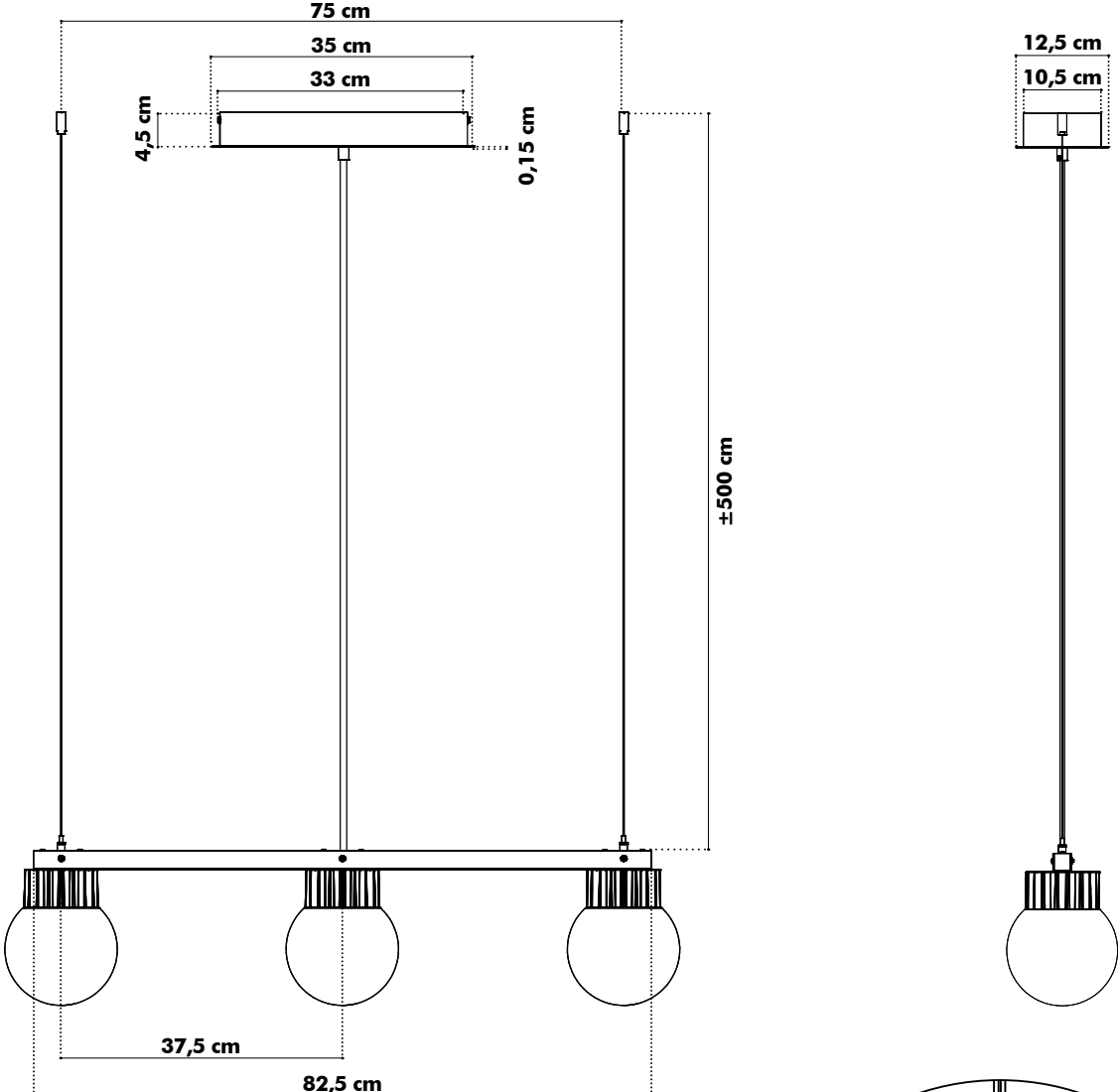

BuzziSol Trio Spot

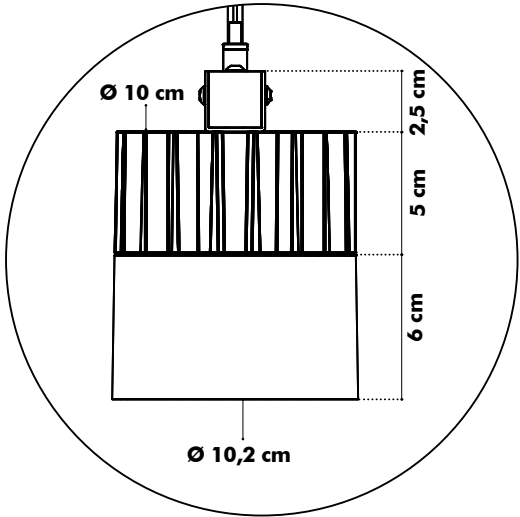
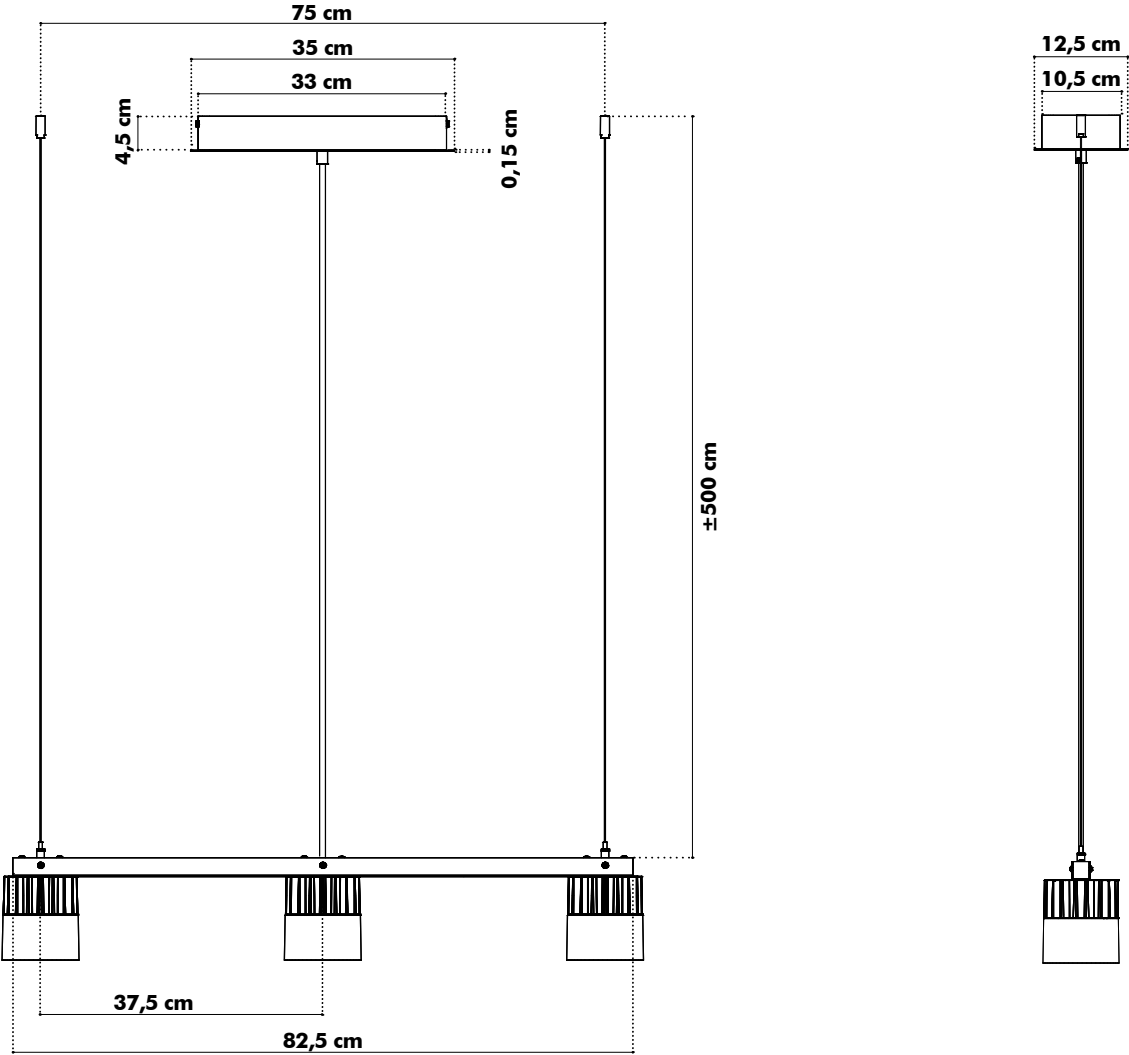

BuzziSol Quintet Globe

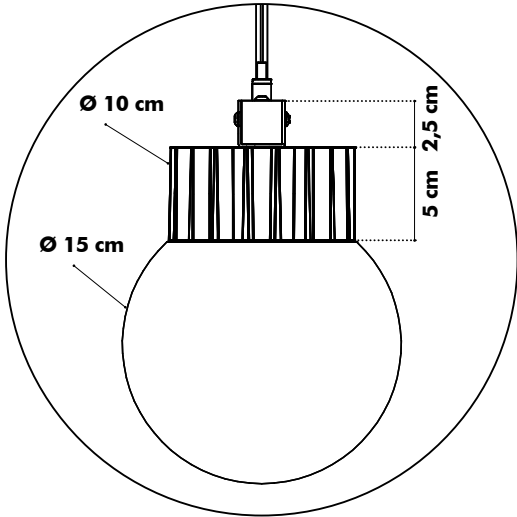
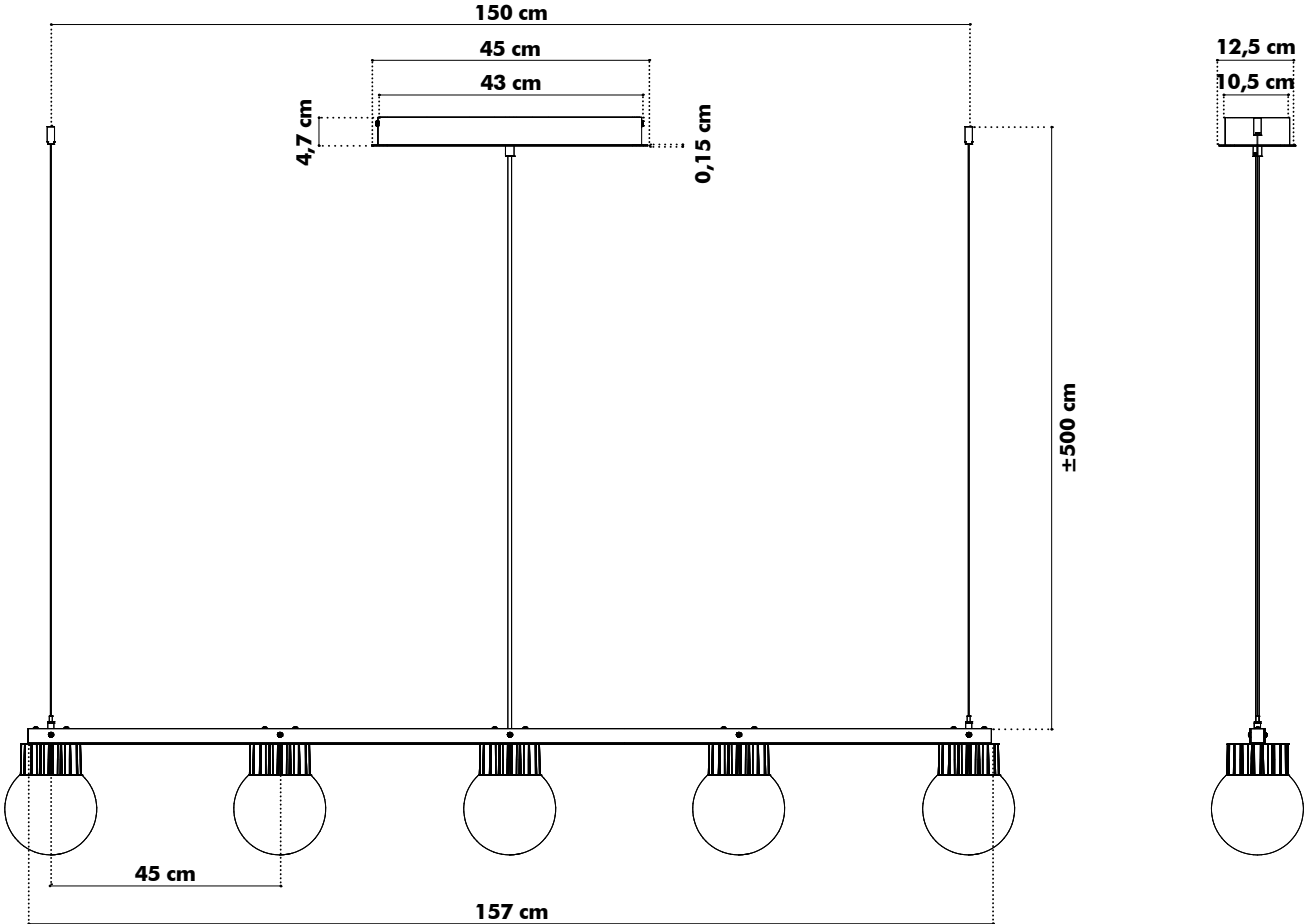

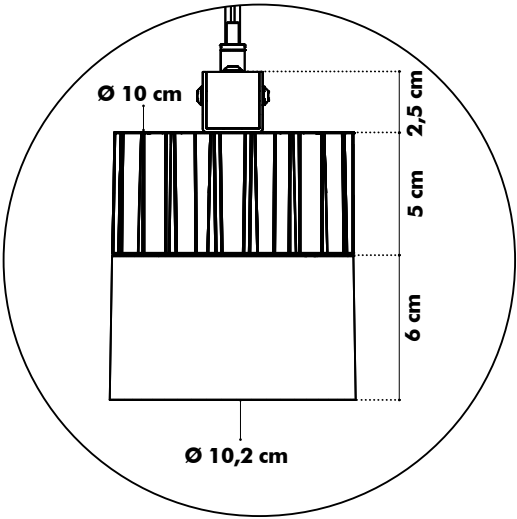
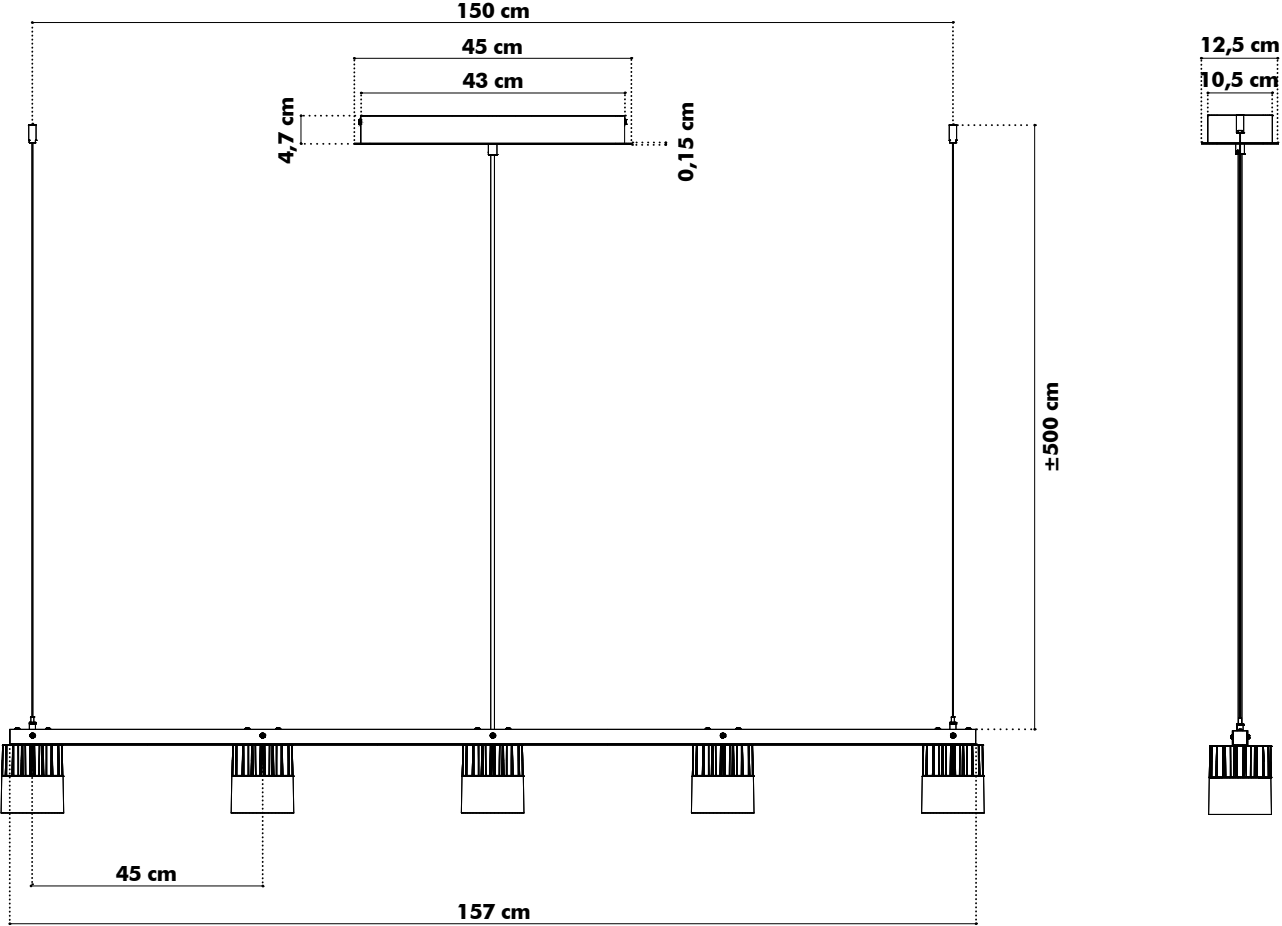

BuzziSol Quintet Spot

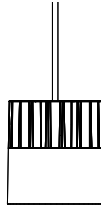
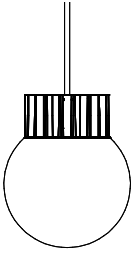

Weights

BuzziSol Solo Globe | Spot



 1,9 kg

BuzziSol Trio Globe | Spot

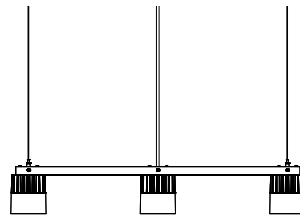
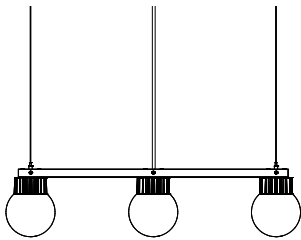

 4,9 kg

BuzziSol Quintet Globe | Spot

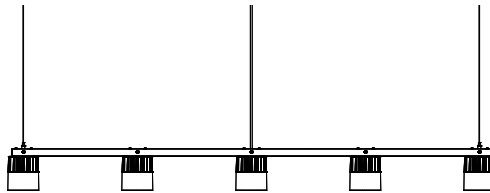
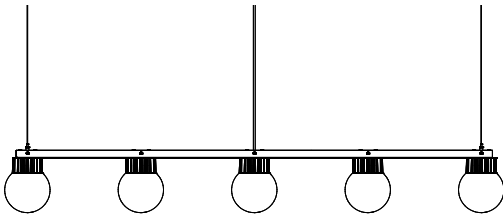

 7,4 kg