

# BuzziProp Retrofit

INSTALLATION MANUAL

MODE DE L'EMPLOI

110V-120V

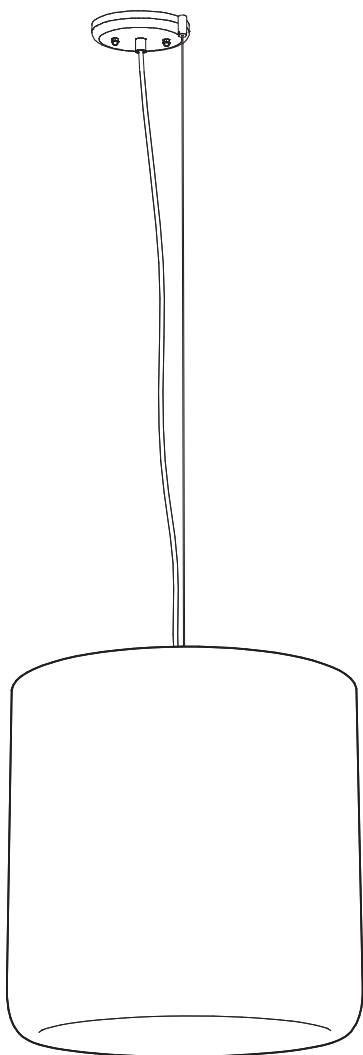

## Technical info

---

E26



Max. 100W

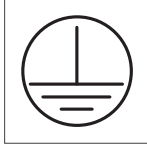
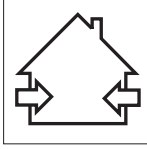

## Excluded

---

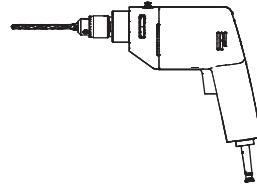
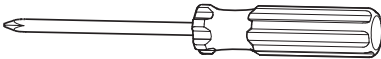
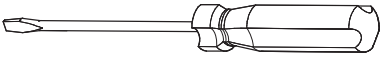

2x

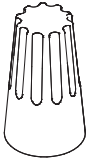

1x

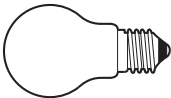

1x

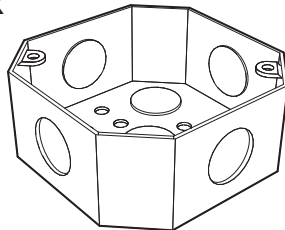

# Included

---

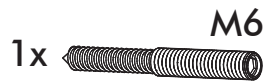
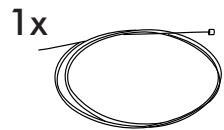
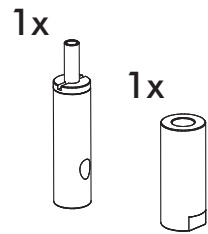
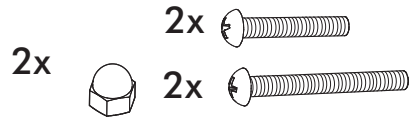
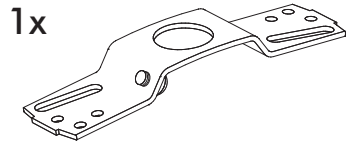
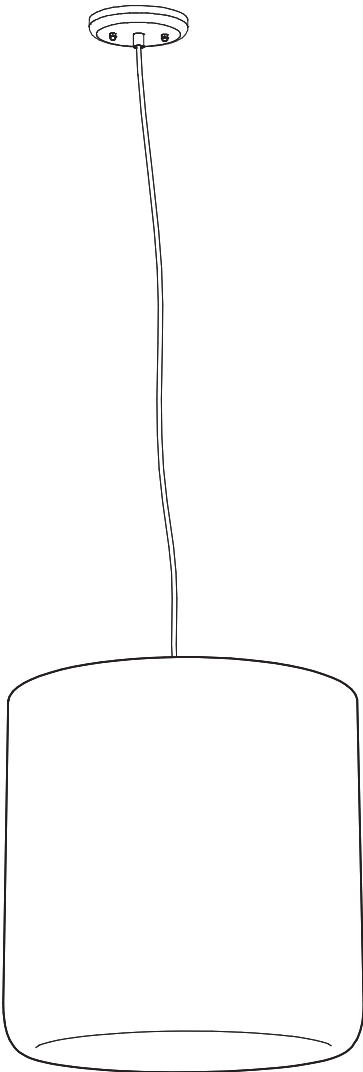

# BuzziProp LED

2 PERS. 

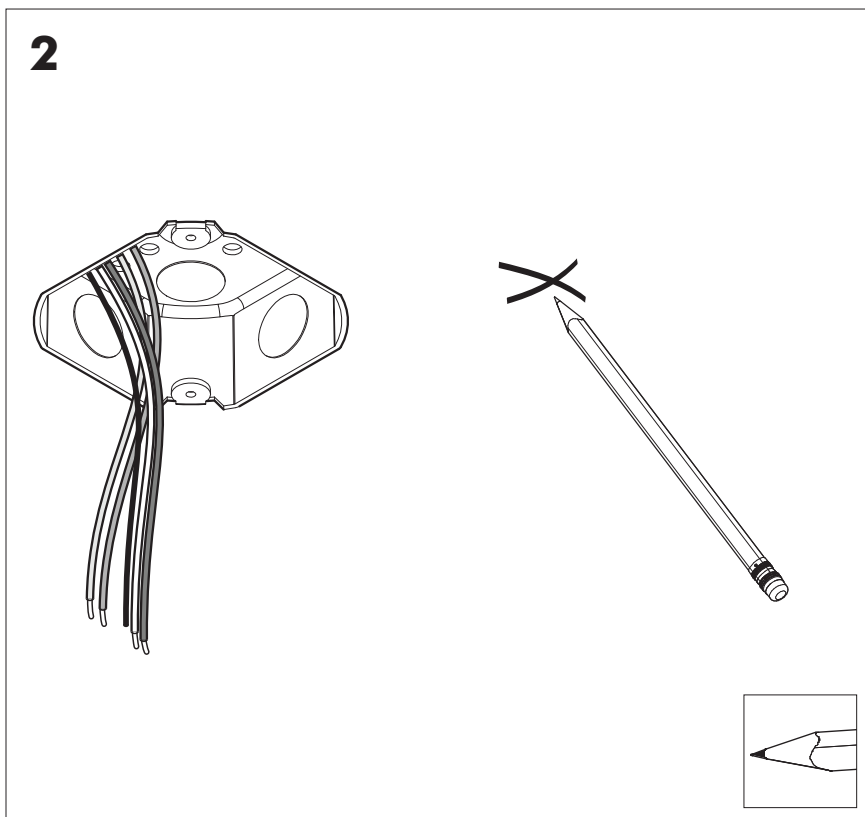
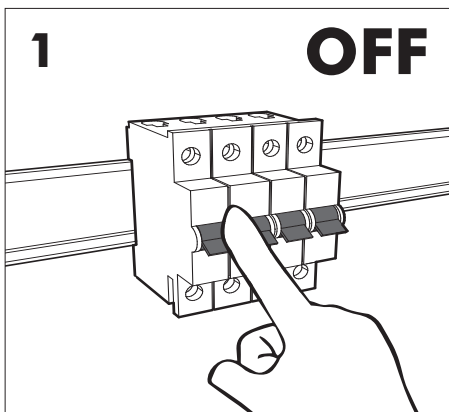
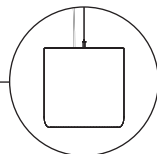

**3**

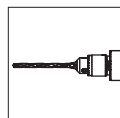
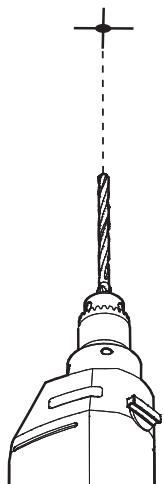
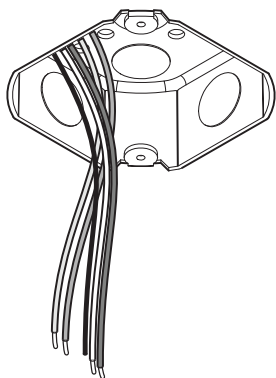

**4**

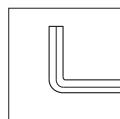
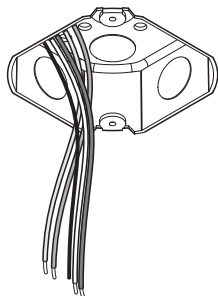

**5**

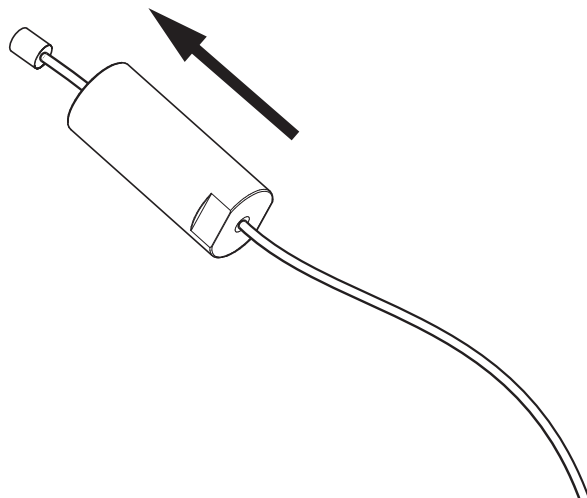
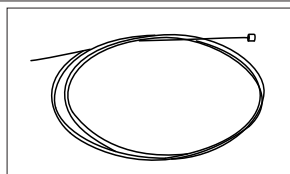

**6**

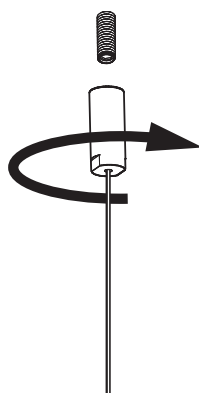
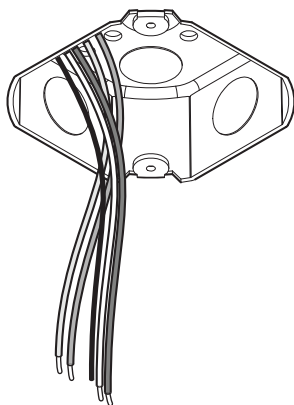

7

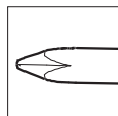
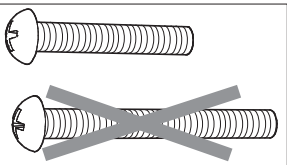
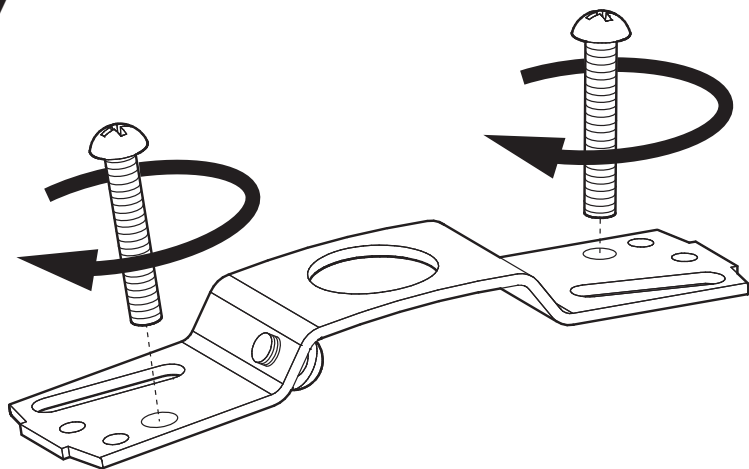

8

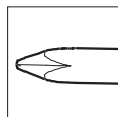
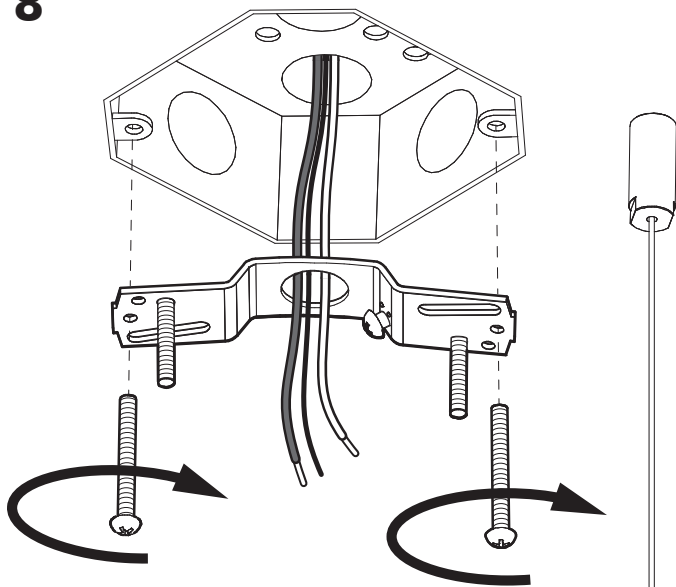

9

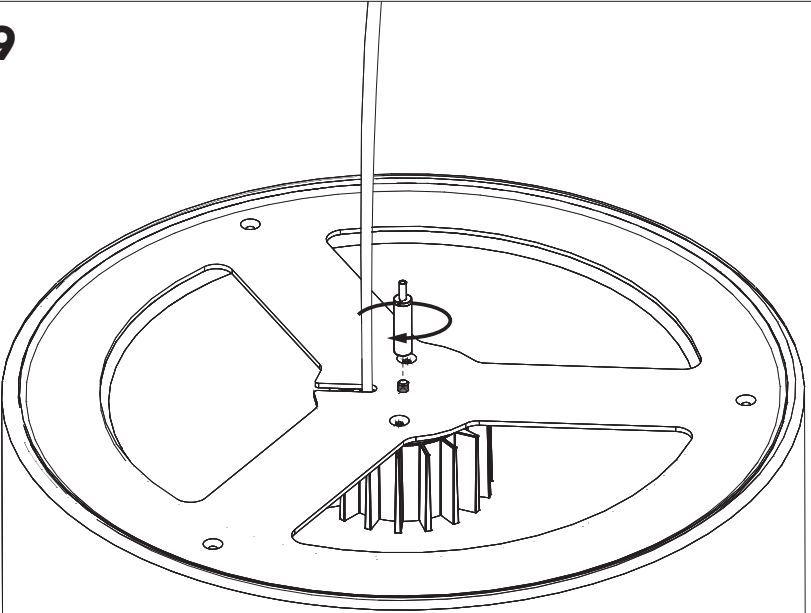

10

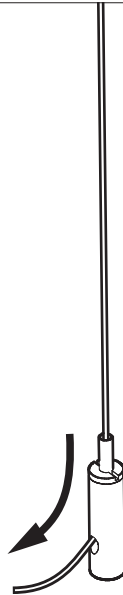
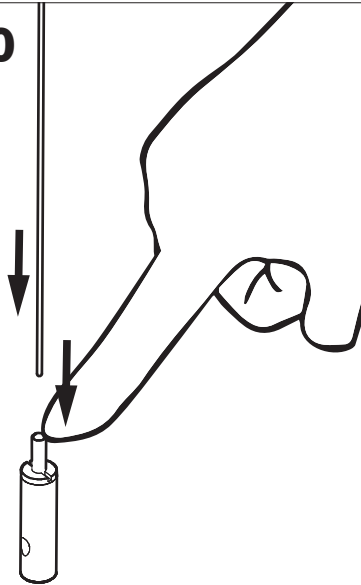



11

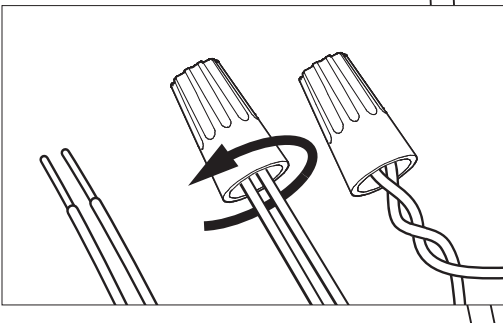
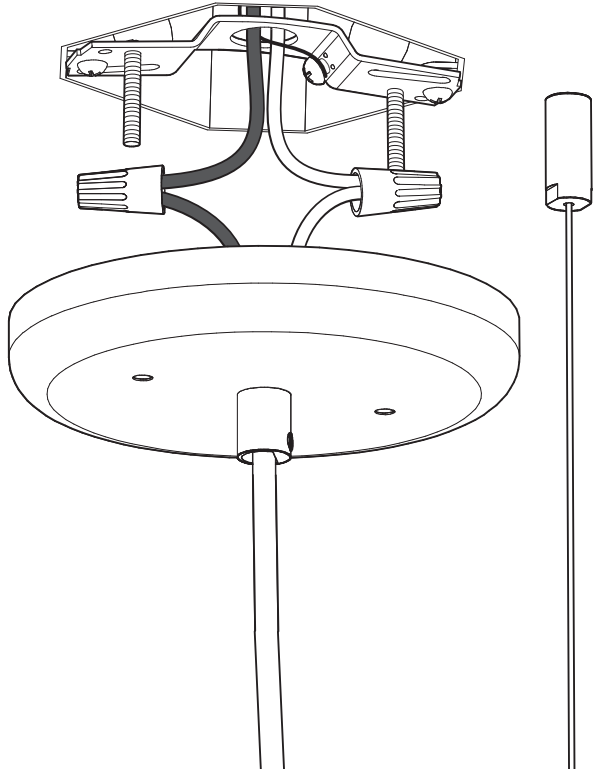
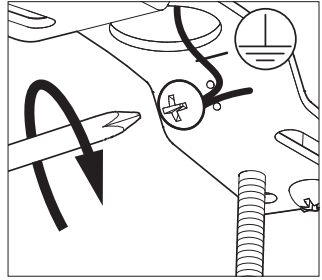

12

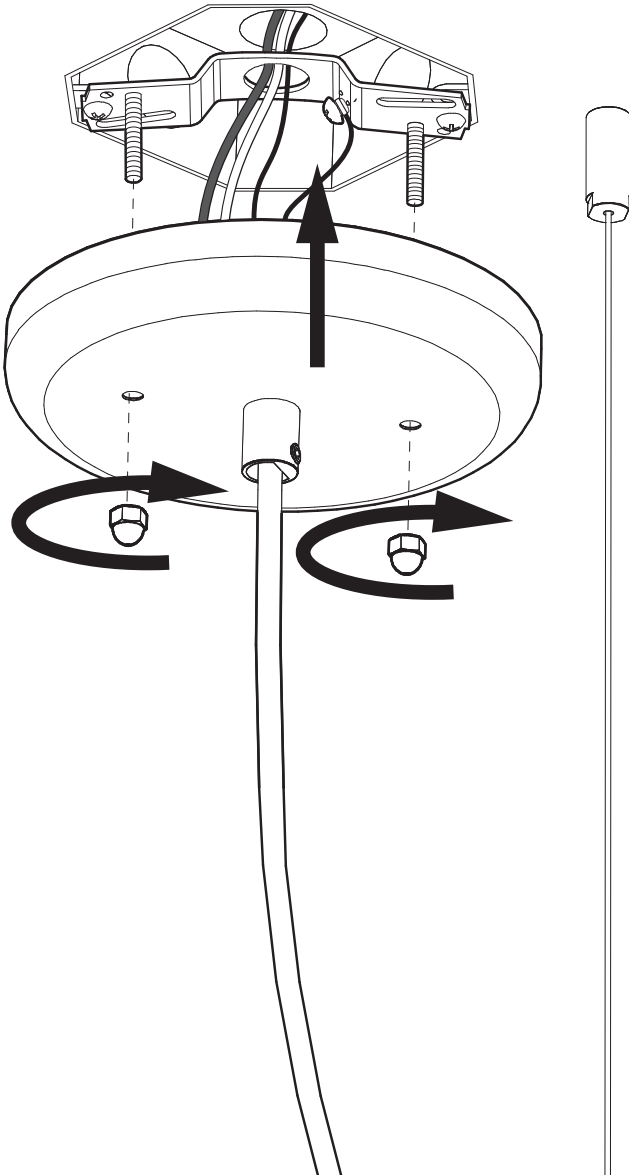

13

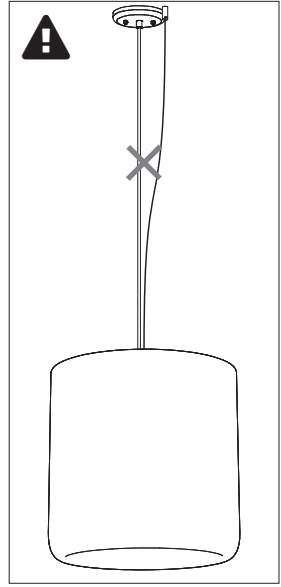
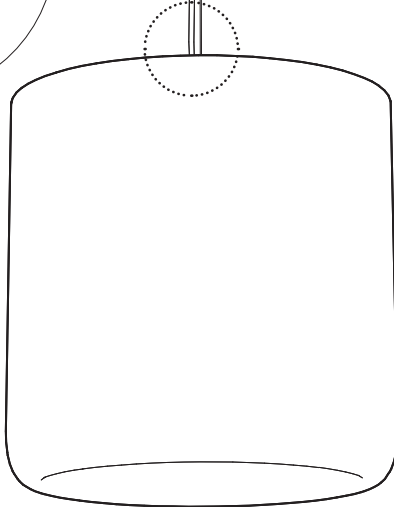
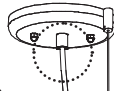
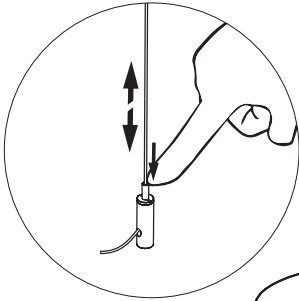
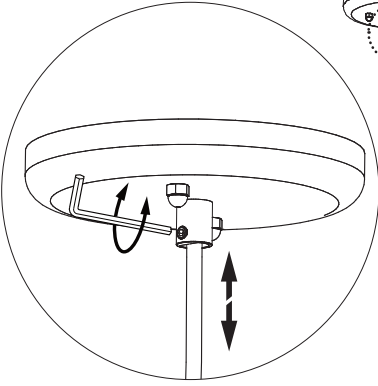

BuzziSpace Group NV  
Italiëlei 8, 2000 Antwerp  
Belgium

☎ +32 (0)3 846 10 00

✉ [info@buzzi.space](mailto:info@buzzi.space)

🌐 [www.buzzi.space](http://www.buzzi.space)



A-0000007483/02  
Last update: 22/02/2024