



Product Specification Sheet

BuzziCone EU

— By BuzziSpace Studio

Conic and Iconic

BuzziCone is a classic yet original noise-reducing lighting, which offers the best of both worlds: light and good silence. This cone-shape slim pendant in soft BuzziFelt offers elegant decorative light, being the perfect addition to any setting. Hang them individually or cluster them in different height to delineate the ideal microenvironment. BuzziCone is available in a wide range of striking BuzziFelt colors. Be even more creative by adding a layer of fabric to the BuzziFelt (inside or outside). You can take your pick from the 3 models based on different angles: 47, 102 and 133.



The Family

Models

BuzziCone 47

BuzziCone 102

BuzziCone 133

Retrofit E27
(bulb excluded)

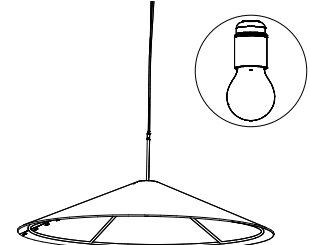
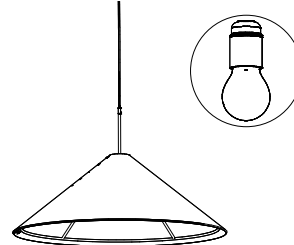
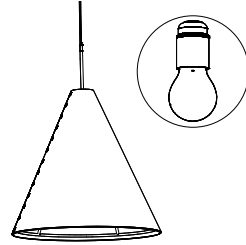

Lighting Units

Sol Solo Globe

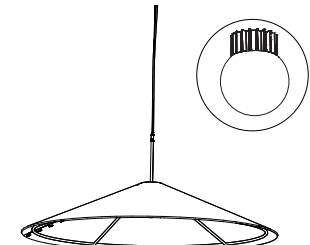
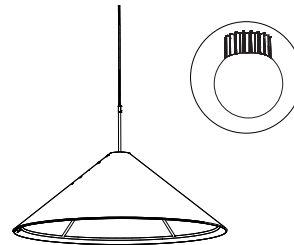
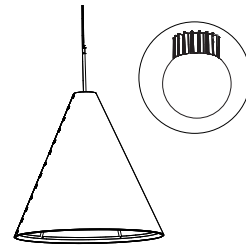

Sol Solo Spot

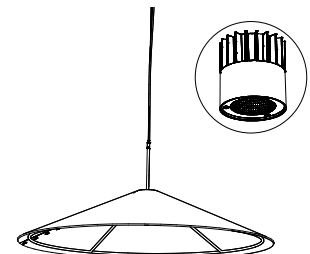
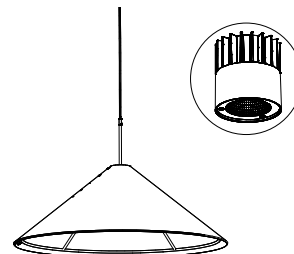
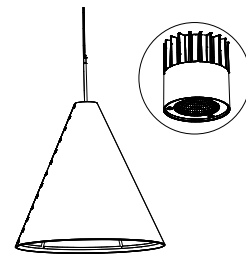

Required order information

1. Size
2. Light Option
3. BuzziFelt Color
3. Optional extra layer inside or outside (CAT -> Collection -> Color)

Lighting Data

Lighting Units

Retrofit Lighting unit



Retrofit E27 bulb excluded, Max 60W.

BuzziSol

Globe

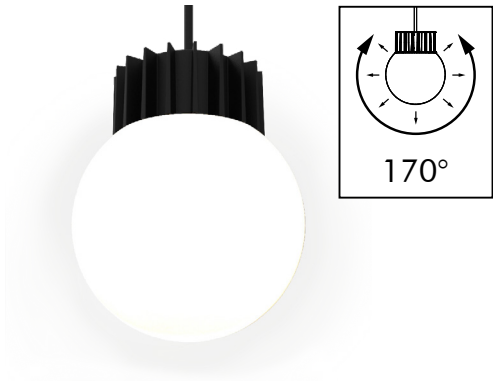

BuzziSol Solo is a suspended LED fixture consisting of 1 powder-coated black heatsink with LED chip on board (COB) light source. The product can be finished with a frosted glass globe diffuser which spreads the light in a large beam angle of 170°, enlightening the surroundings or a reflector spot adaptor directing the light with a beam angle of 38° downwards.

Spot



Lighting specifications

BuzziCone 47

Lighting Unit	Voltage	Wattage	Light Output Luminaire	Efficacy (Lm/W)	CRI	Dimming	Color Temperature	UGR	Standard (stock) On request (>LT)	Color Power Cable	Color Ceiling Canopy	Fabric Collection	Fabric Color	Mounting Option
Retrofit E27 bulb excl.	220 - 240V	Max.60W	-	-	-	-	-	-	Standard	Black	Black	-	-	-
Sol Solo Globe	220 - 240V	20W	1500 Lm	75	90	1-10V	3000K	23	Standard	Black	Black	Use color codes below	Use color codes below	1 cable of 2 m or 5 m Black
Sol Solo Globe	220 - 240V	20W	1500 Lm	75	90	DALI	3000K	23	On Request	Black	Black	Use color codes below	Use color codes below	1 cable of 2 m or 5 m Black
Sol Solo Spot	220 - 240V	20W	1500 Lm	75	90	1-10V	3000K	12	Standard	Black	Black	-	-	-
Sol Solo Spot	220 - 240V	20W	1500 Lm	75	90	DALI	3000K	12	On Request	Black	Black	-	-	-

BuzziCone 102

Lighting Unit	Voltage	Wattage	Light Output Luminaire	Efficacy (Lm/W)	CRI	Dimming	Color Temperature	UGR	Standard (stock) On request (>LT)	Color Power Cable	Color Ceiling Canopy	Fabric Collection	Fabric Color	Mounting Option
Retrofit E27 bulb excl.	220 - 240V	Max.60W	-	-	-	-	-	-	Standard	Black	Black	-	-	-
Sol Solo Globe	220 - 240V	20W	1500 Lm	75	90	1-10V	3000K	23	Standard	Black	Black	Use color codes below	Use color codes below	1 cable of 2 m or 5 m Black
Sol Solo Globe	220 - 240V	20W	1500 Lm	75	90	DALI	3000K	23	On Request	Black	Black	Use color codes below	Use color codes below	1 cable of 2 m or 5 m Black
Sol Solo Spot	220 - 240V	20W	1500 Lm	75	90	1-10V	3000K	12	Standard	Black	Black	-	-	-
Sol Solo Spot	220 - 240V	20W	1500 Lm	75	90	DALI	3000K	12	On Request	Black	Black	-	-	-

BuzziCone 133

Lighting Unit	Voltage	Wattage	Light Output Luminaire	Efficacy (Lm/W)	CRI	Dimming	Color Temperature	UGR	Standard (stock) On request (>LT)	Color Power Cable	Color Ceiling Canopy	Fabric Collection	Fabric Color	Mounting Option
Retrofit E27 bulb excl.	220 - 240V	Max.60W	-	-	-	-	-	-	Standard	Black	Black	-	-	-
Sol Solo Globe	220 - 240V	20W	1500 Lm	75	90	1-10V	3000K	23	Standard	Black	Black	Use color codes below	Use color codes below	1 cable of 2 m or 5 m Black
Sol Solo Globe	220 - 240V	20W	1500 Lm	75	90	DALI	3000K	23	On Request	Black	Black	Use color codes below	Use color codes below	1 cable of 2 m or 5 m Black
Sol Solo Spot	220 - 240V	20W	1500 Lm	75	90	1-10V	3000K	12	Standard	Black	Black	-	-	-
Sol Solo Spot	220 - 240V	20W	1500 Lm	75	90	DALI	3000K	12	On Request	Black	Black	-	-	-



CE CB

Photometric Data

BuzziCone BuzziSol Solo

Solo Solo Globe Cartesian diagram

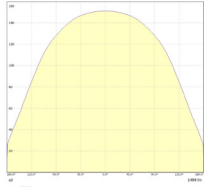

Solo Solo Globe Polar curve

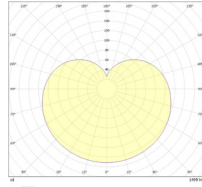

Solo Solo Spot Cartesian diagram

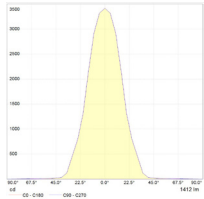

Solo Solo Spot Polar curve

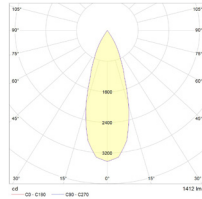

Tips and Tricks - Light Options

To enlighten your workplace with optimal lux levels take following measurements into account:

BuzziCone BuzziSol Solo

Solo Spot

Office,
Meeting room

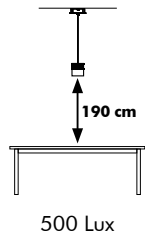

Solo Globe

Office,
Meeting room

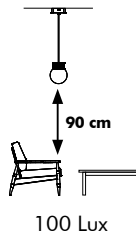

* According to EN12464

Product Data

Fixing System

Fixing System Acoustic Panel

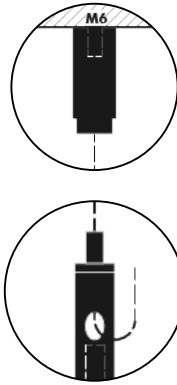
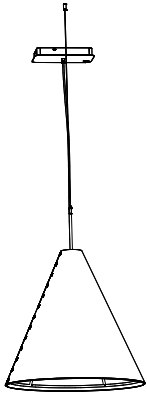

BuzziCone is suspended on 1 cable of 2 or 5m black colored, with fixing screw.

⚠ If installing on suspended ceiling, verify load capacity prior to installation.

Acoustic Panel



The acoustic panel consists of one layer of BuzziFelt, finished with push buttons in glossy black. Optional an extra layer of Fabric or Hero 2 can be added on the inside or outside.



Absorption



Diffusion



Mid tone



High tone

Acoustics Data

BuzziCone

Equivalent sound absorption area in m² per object

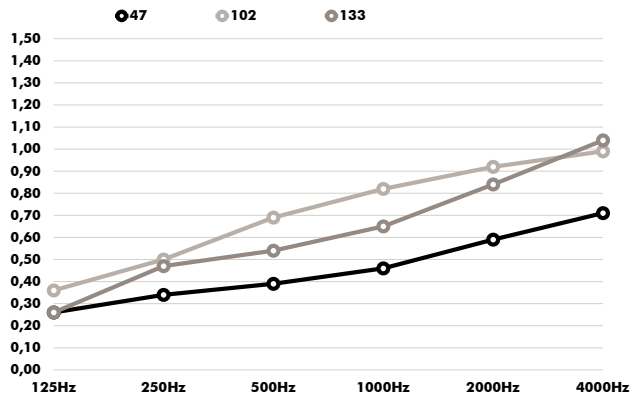

Hz	Cone 47 Aeq/m ²	Cone 102 Aeq/m ²	Cone 133 Aeq/m ²
125	0.26	0.36	0.26
250	0.34	0.50	0.47
500	0.39	0.69	0.54
1000	0.46	0.82	0.65
2000	0.59	0.92	0.84
4000	0.71	0.99	1.04

Dimensions

BuzziCone 47 Retrofit

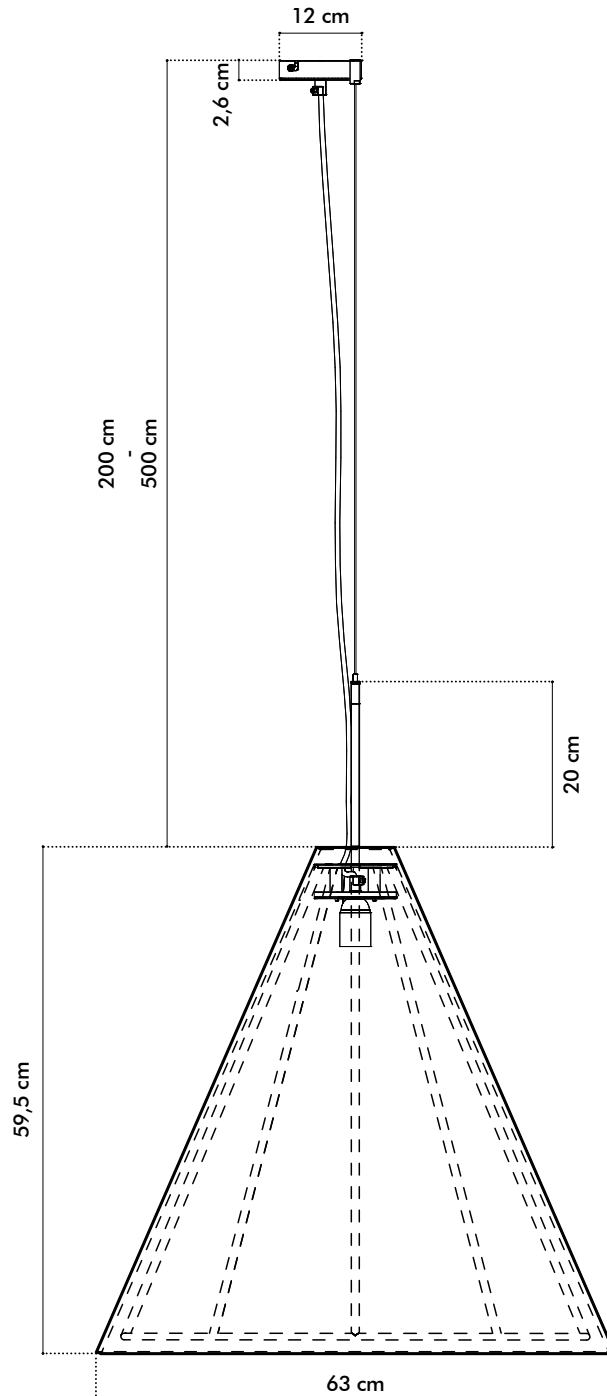

BuzziCone 47 LED

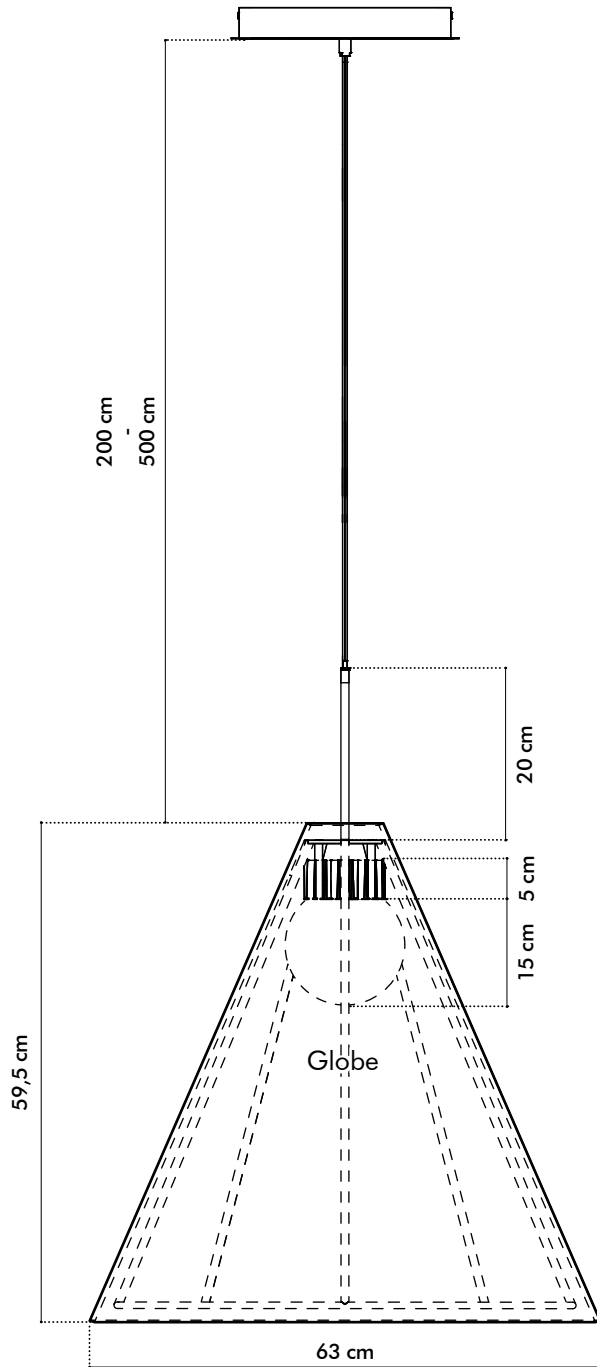

Front

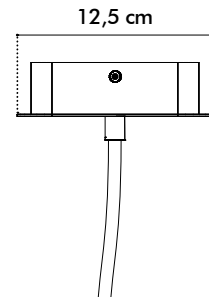

Side

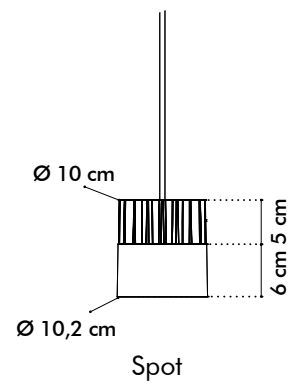
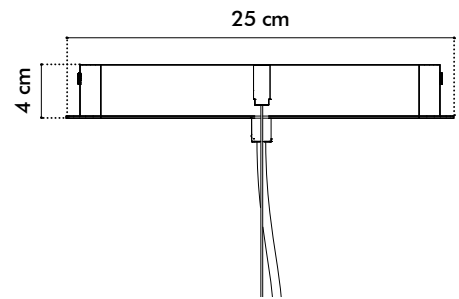

BuzziCone 102 Retrofit

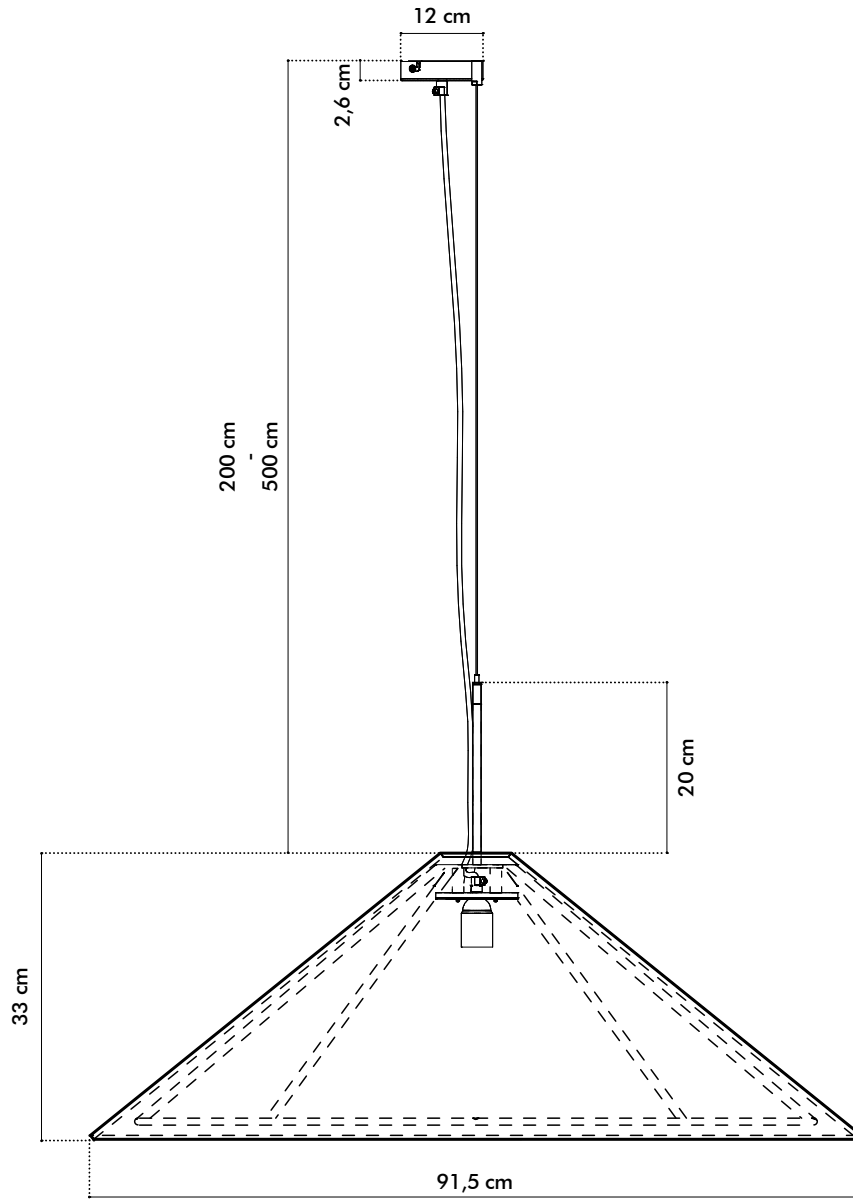

BuzziCone 102 LED

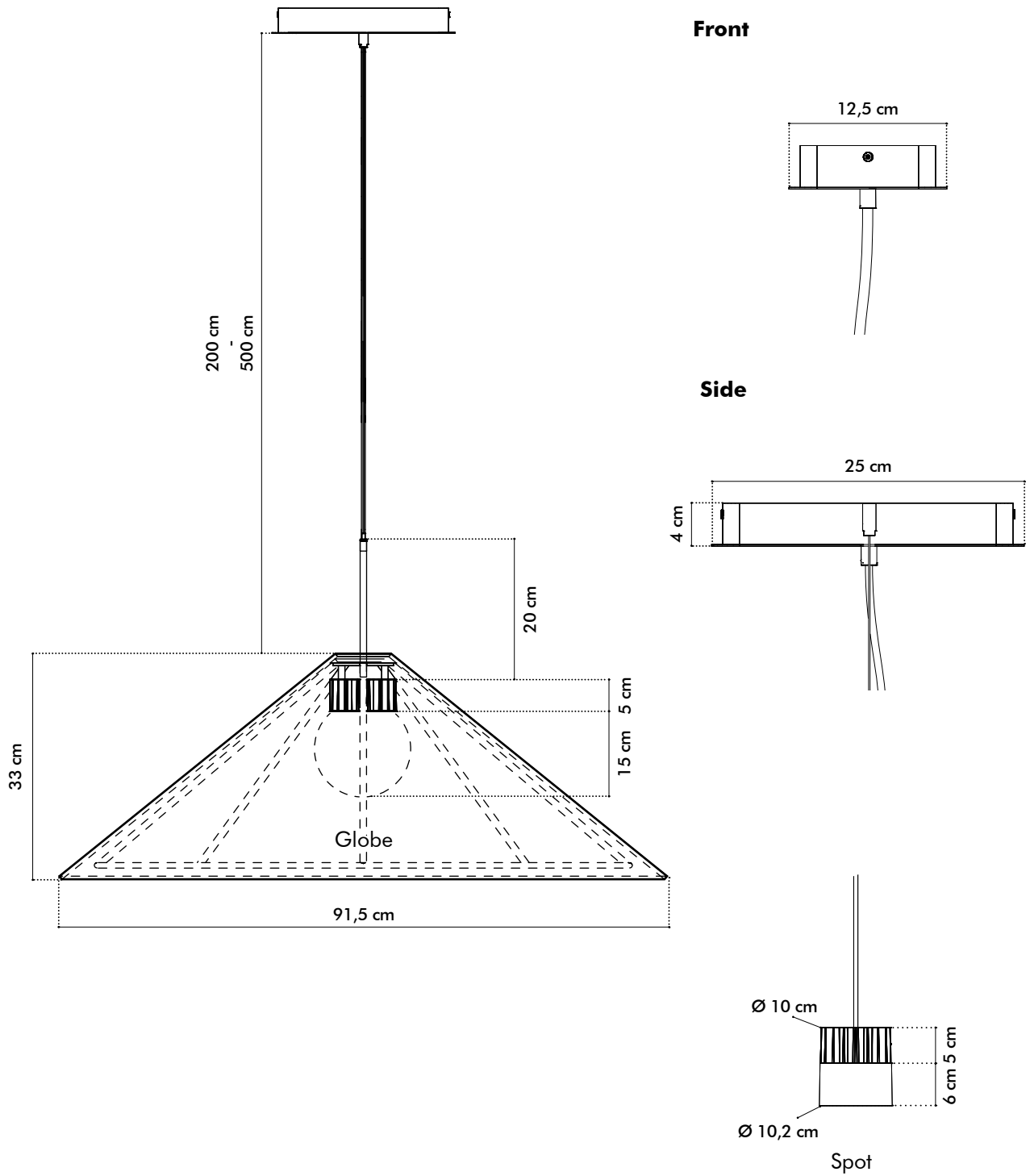

BuzziCone 133 Retrofit

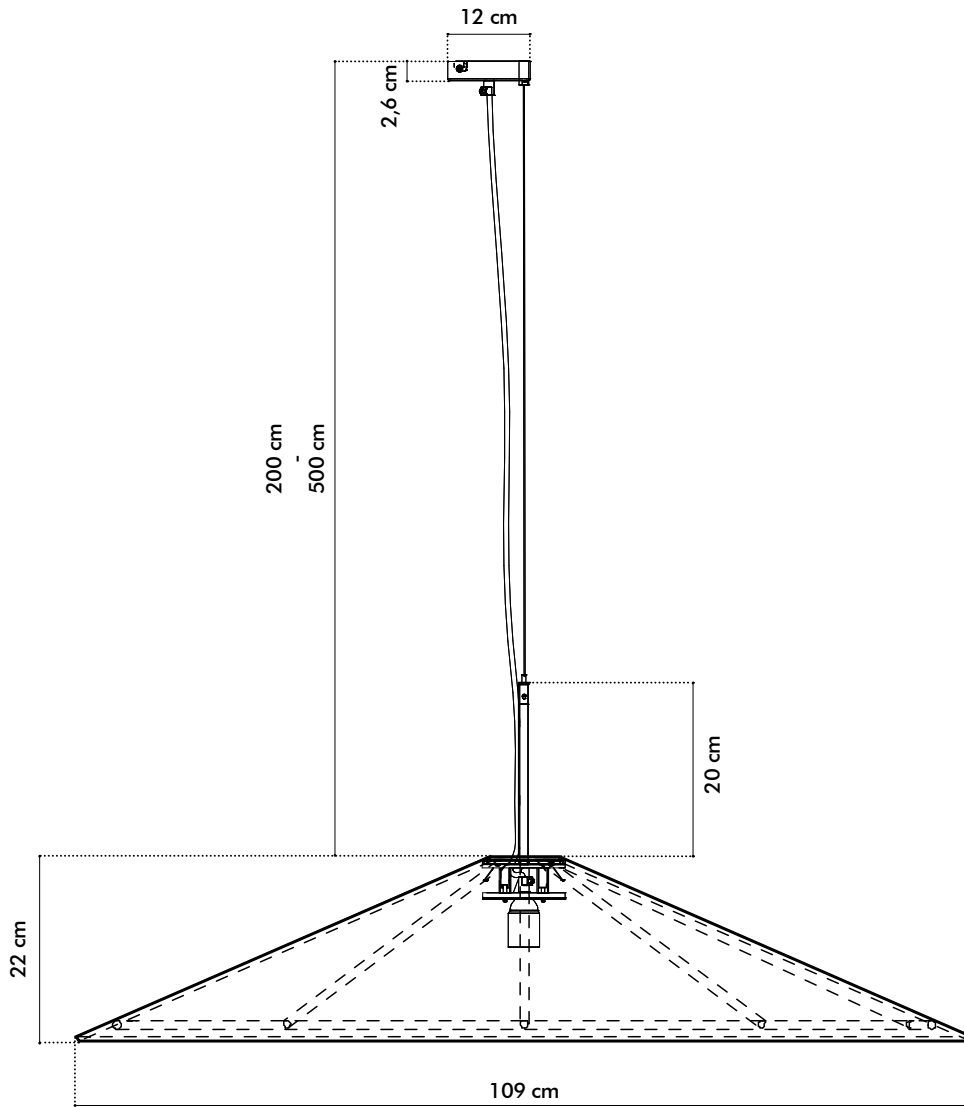

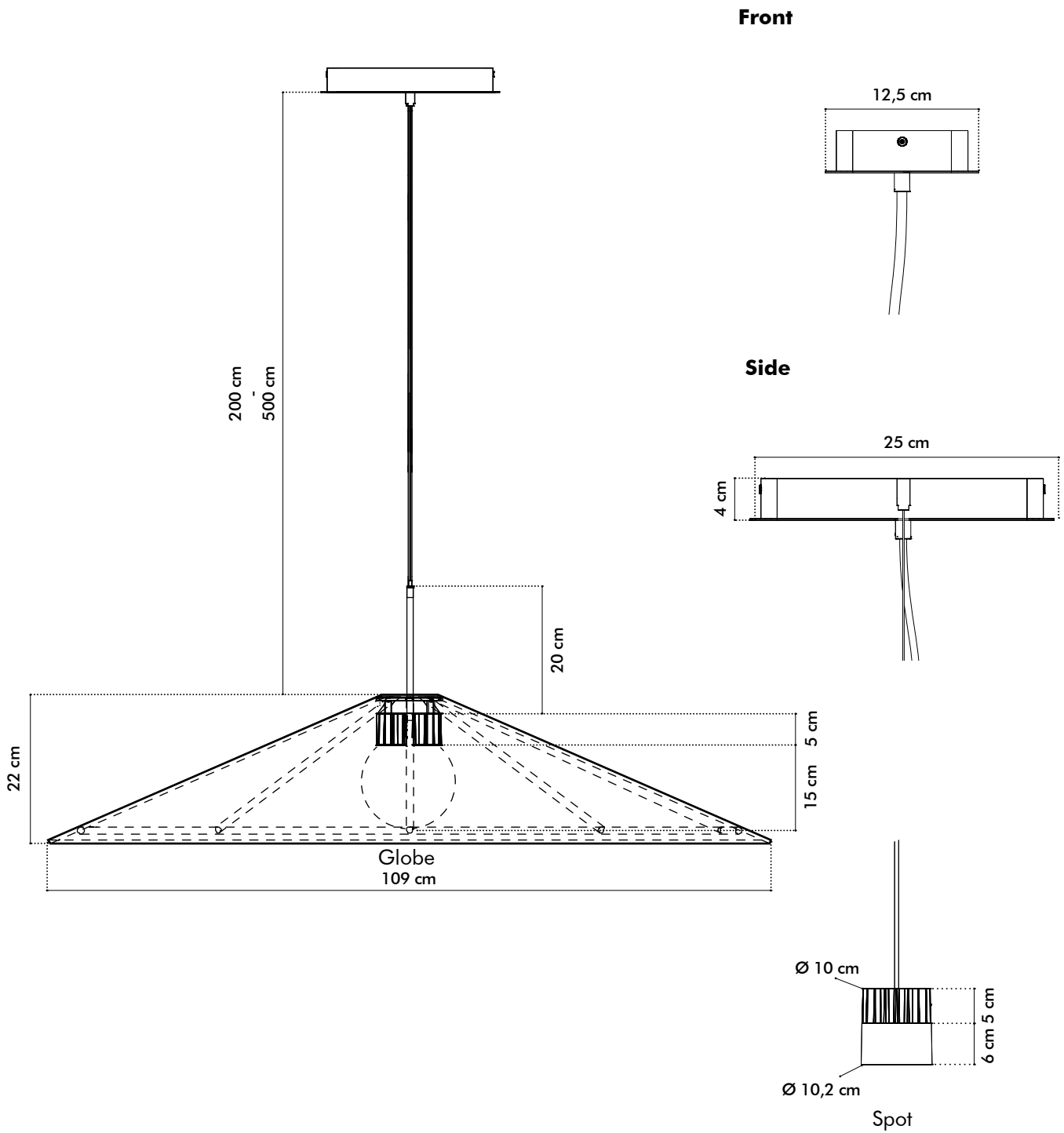

BuzziCone 133 LED

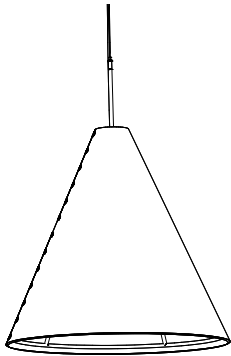

Weights

BuzziCone 47



 6,5 kg

BuzziCone 102



 7 kg

BuzziCone 133

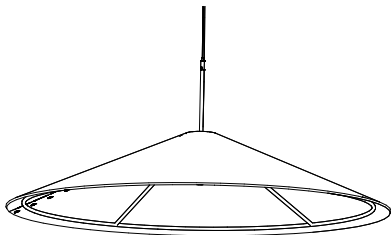

 7,5 kg

Fabrics

Felt (12 colors)

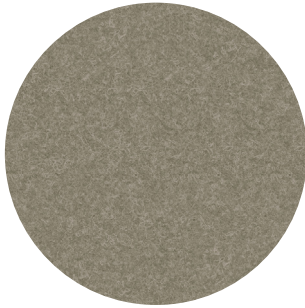

Composition 100% Recycled PE.T. Felt, latex backing
Weight 1.000 g/m² | 29.49 oz/yd²
Abrasion resistance >7.000 Martindale
Flammability EU: EN 13501.1 + A1/2009 Class B-s1,d0
USA: ASTM E84 Class A certified
Fastness to light USA 5



Fabric (45 colors)

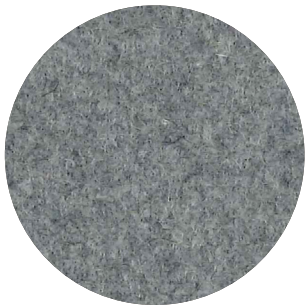

Category A
Composition 70% Recycled Wool, 25% Recycled Polyacryl,
5% Recycled Other Fabrics
Weight 405 g/m² | 11.94 oz/yd²
Abrasion resistance 40.000 Martindale, 50,000 Wyzenbeek
Flammability EU: EN 1021.1/2006 | BS EN 1021.1/2006 (cigarette).
EN 1021.2/2006 | BS EN 1021.2/2006 (match)
USA: CAL TB 117 | ASTM E84 CLASS A
Fastness to light EU: 4 | USA 4
Fastness to rubbing EU: Wet 3-4 | Dry 4-5
Fastness to crocking USA: Wet 5 | Dry 5



Hero 2 (33 colors)

kvadrat

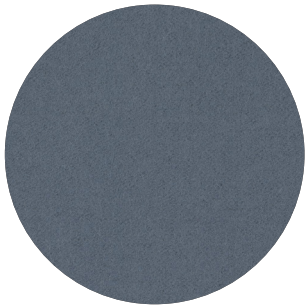

Category C
Composition 97% new wool, 3% nylon
Weight 580 g/lin.m
Abrasion resistance 45.000 Martindale rubs, EN ISO 12947
Flammability EN 1021-1/2 | DIN 4102 B2 | NF D 60 013
UNI 9175 1IM | US Cal. Bull. 117-2013 | NFPA 260
IMO A.652 (16)
Fastness to light Note 5-6, ISO 105-B02
Fastness to rubbing (ISO) dry 4-5, wet 4-5
Pilling Note 3-4, EN ISO 12945

