



Product Specification Sheet

BuzziMoon US

— By BuzziSpace Studio

Embedded light

BuzziMoon offers the best of both worlds; highly functional general lighting embedded in a proven acoustic ceiling solution. One of the first acoustical lighting solutions that is equally performant on lighting as on acoustic level. The LED light module is designed specifically to answer the request of general lighting in office space. The Moon can be finished off in different fabrics and various 3D patterns. The diffuser gives it a “full moon” lighting experience. BuzziMoon is equally available in EU and US.



The Family

Models

BuzziMoon Round

BuzziMoon Oval

LED Disk

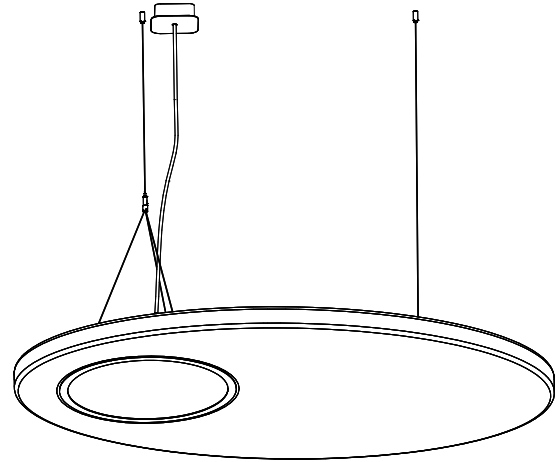
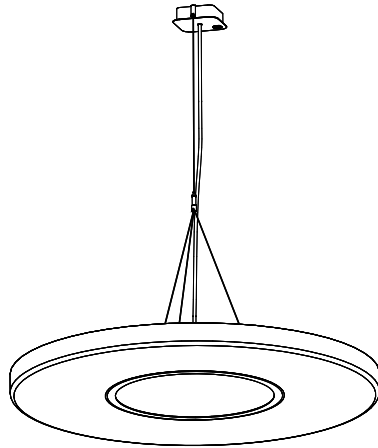

Required order information

1. Model
2. Size
3. Pattern
4. Fabric (CAT -> Collection -> Color)
5. Lighting Options (Voltage Input, Color Temperature, UGR, Dimming)
6. Mounting Option

Lighting Data

Lighting Unit

LED Disk



The BuzziMoon consist of a LED PCB solution containing mid power LED's to create an optimal light spread. The LED solution is available in a color temperature of 3000K or 4000K

Select a milky diffuser to achieve a diffuse light surface without any dottiness. Or select a prismatic diffuser to achieve an UGR value of 19. LED dots will be visible



UGR 22
Milky Diffuser



UGR 19
Prismatic Diffuser

BuzziMoon Suspended Lighting options

Models: Round | Oval | S | M | L

Lighting Options

Characteristics

Mounting

Voltage Input	Color Temperature	UGR (Diffuser type)	Dimming	Technical	Visual	Pattern	Options
120V	3000K	22 (milky)	1-10V Dali	Power consumption: 35W Light output: 3170 Lm Efficacy: 91 Lm/W CRI > 90	Color: Power Cable: Black Ceiling Canopy: Black	Flat, 3D Rib, 3D Drop*, 3D Leaf	Ceiling Suspended Straight: 3 cables 78.74" or 196.85" Alu or Black Split: 1 cable splits in 3 78.74" or 196.85" Alu or Black
		19 (prismatic)**	1-10V Dali	Power consumption: 35W Light output: 3600 Lm Efficacy: 103 Lm/W CRI > 90			
	4000K	22 (milky)	1-10V Dali	Power consumption: 35W Light output: 3400 Lm Efficacy: 97 Lm/W CRI > 90			
		19 (prismatic)**	1-10V Dali	Power consumption: 35W Light output: 3660 Lm Efficacy: 105 Lm/W CRI > 90			
	3500K	22 (milky)	1-10V	Power consumption: 29W Light output: 2545 Lm Efficacy: 88 Lm/W CRI > 90			
	277V	3000K	22 (milky)	1-10V			
3500K							

BuzziMoon Ceiling Mounted Lighting options

Models: Round | S | M | L

Options			Characteristics			Mounting
Voltage Input	Color Temperature	UGR (Diffuser type)	Dimming	Technical	Pattern	Options
120V	3000K	22 (milky)	1-10V Dali	Power consumption: 35W Light output: 3170 Lm Efficacy: 91 Lm/W CRI > 90	Flat, 3D Rib, 3D Drop*, 3D Leaf	Ceiling Mounted
		19 (prismatic)**	1-10V Dali	Power consumption: 35W Light output: 3600 Lm Efficacy: 103 Lm/W CRI > 90		
	4000K	22 (milky)	1-10V Dali	Power consumption: 35W Light output: 3400 Lm Efficacy: 97 Lm/W CRI > 90		
		19 (prismatic)**	1-10V Dali	Power consumption: 35W Light output: 3660 Lm Efficacy: 105 Lm/W CRI > 90		

* 3D Drop not possible for Oval

** To achieve a UGR 19, the product is fitted with a Prismatic diffuser instead of a milky diffuser. LED dots will be visible.



Photometric Data

BuzziMoon LED Disk

LED Disk Cartesian diagram

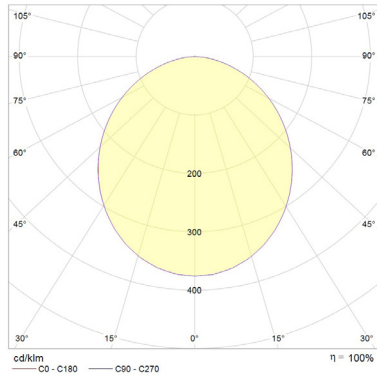

LED Disk Polar curve

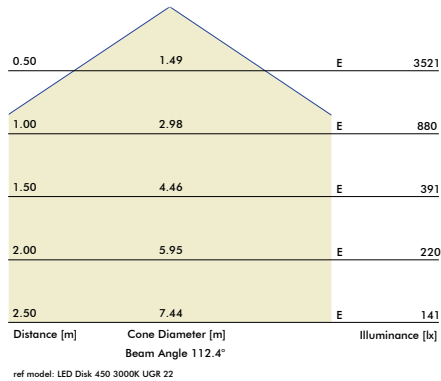

Tips and Tricks - Light Options

To enlight your workplace with optimal lux levels take following measurements into account:

BuzziMoon LED Disk

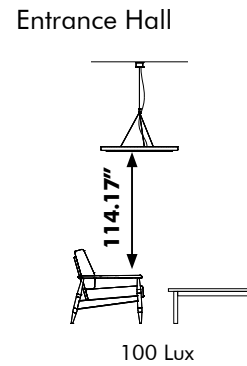
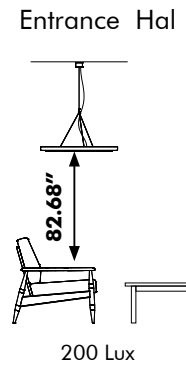
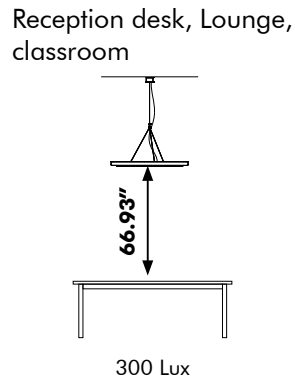
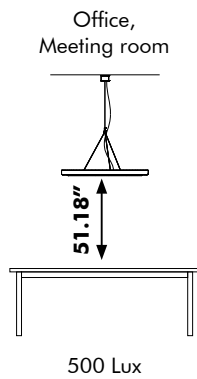

* According to EN12464

Product Data

Fixing System

Round

Ceiling Mounted

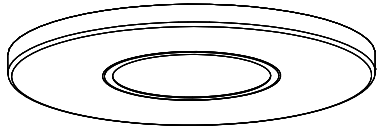

Ceiling Suspended Straight

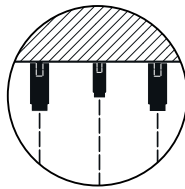
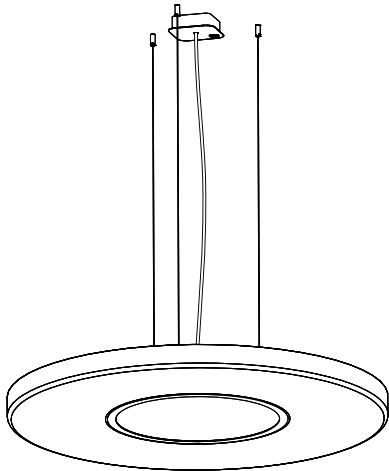

Ceiling Suspended Straight
Fixing System Screw with 3 cables of
78.74" or 196.85" (black or alu)

Ceiling Suspended Split

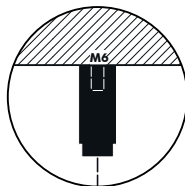
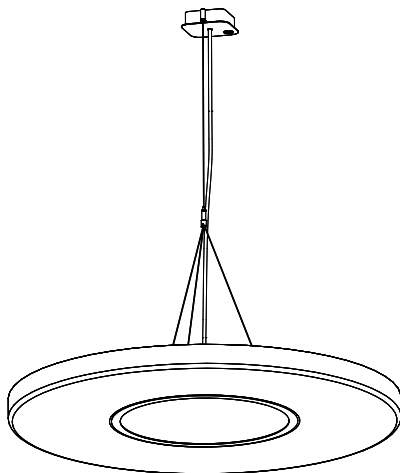

Ceiling Suspended Split
Fixing System Screw with 3 split cables and 1 main
cable, total length of 78.74" or 196.85"
(black or alu)
Min. distance of shade to ceiling is 19.69"

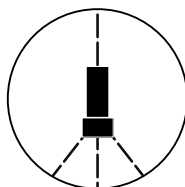

Oval

Ceiling Suspended Straight

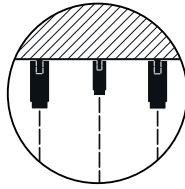
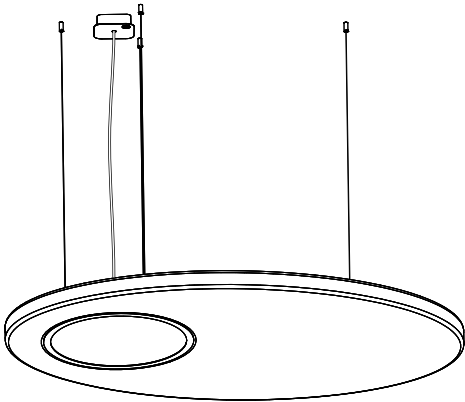

Ceiling Suspended Straight
Fixing System Screw with 4 cables of
78.74" or 196.85" (black or alu)

Ceiling Suspended Split

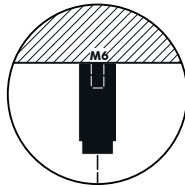
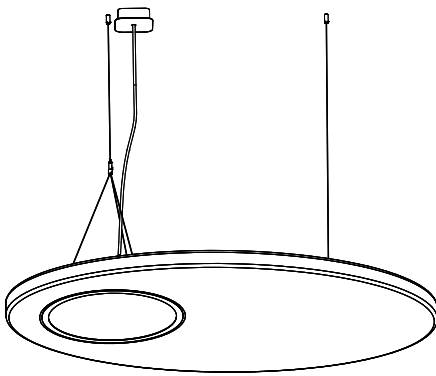

Ceiling Suspended Split
Fixing System Screw with 3 split cables and 1 main
cable, total length of 78.74" or 196.85"
(black or alu)
Min. distance of shade to ceiling is 19.69"

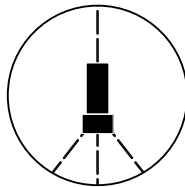

▲ If installing on suspended ceiling, verify load capacity prior to installation.

Acoustic Panel



The acoustic panel is upholstered top to bottom in a
chosen fabric



Absorption



Diffusion



Mid tone



High tone

Patterns Round

Flat

L

M

S

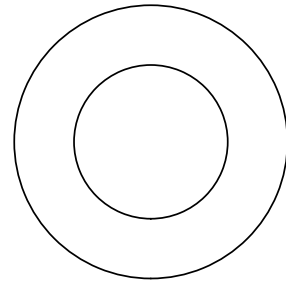
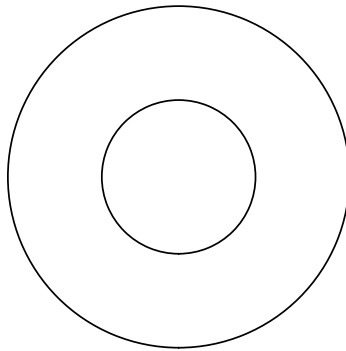
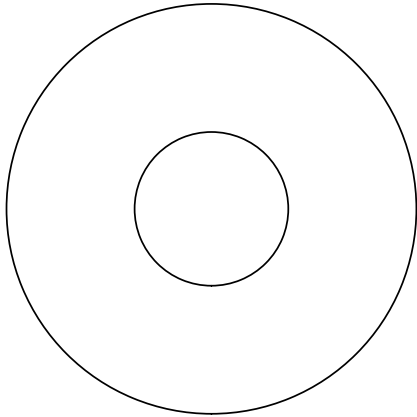

3D Rib

L

M

S

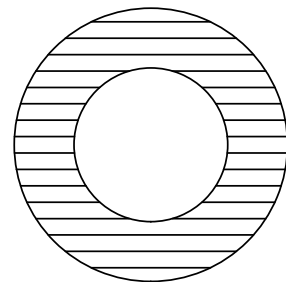
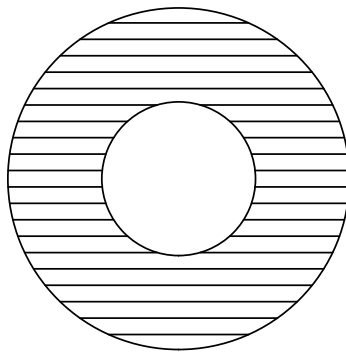
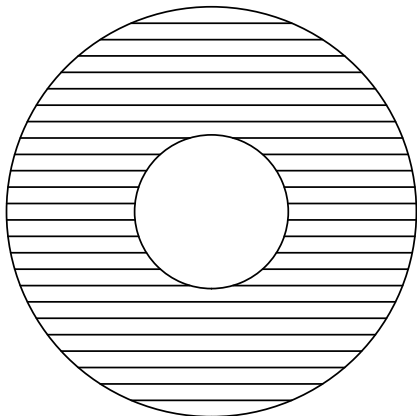

3D Leaf

L

M

S

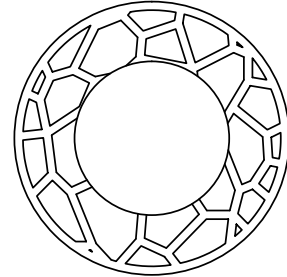
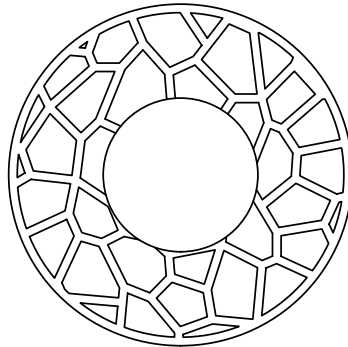
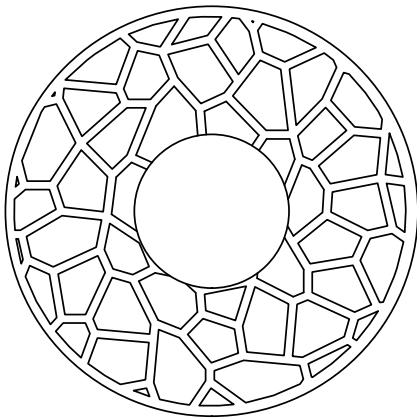

3D Drop

L

M

S

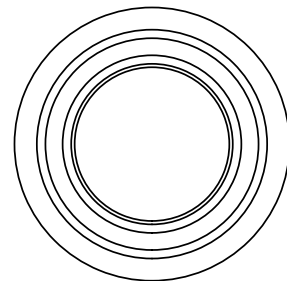
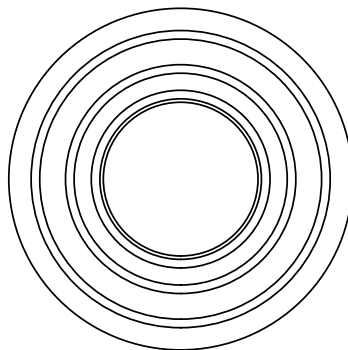
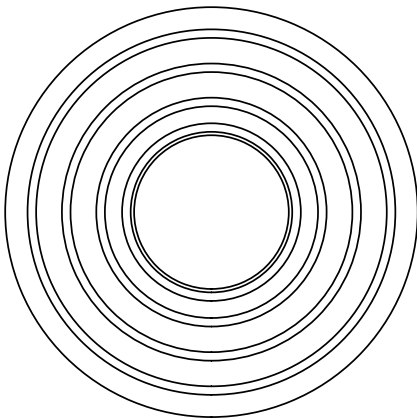

Patterns Oval

Flat

M

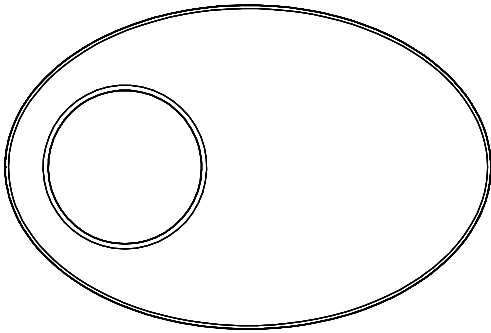

S

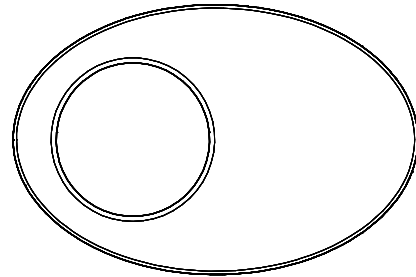

3D Leaf

M

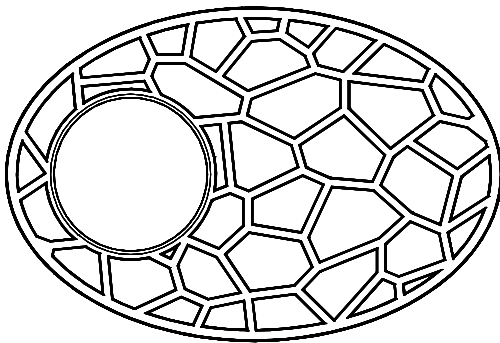

S

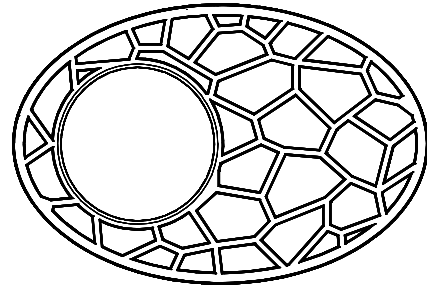

3D Rib

M

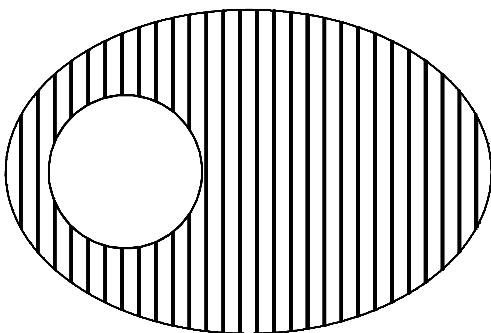

S

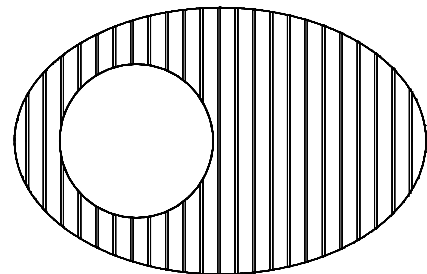

Acoustics

BuzziMoon Round

Equivalent sound absorption area in m² per object

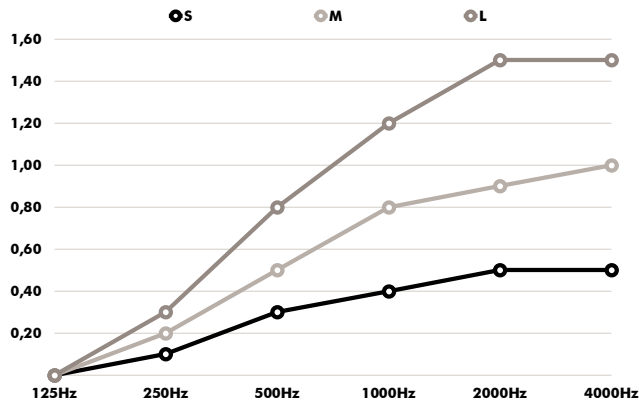

Hz	S Aeq/m ²	M Aeq/m ²	L Aeq/m ²
125	0.0	0.0	0.0
250	0.1	0.2	0.3
500	0.3	0.5	0.8
1000	0.4	0.8	1.2
2000	0.5	0.9	1.5
4000	0.5	1	1.5

BuzziMoon Oval

Equivalent sound absorption area in m² per object

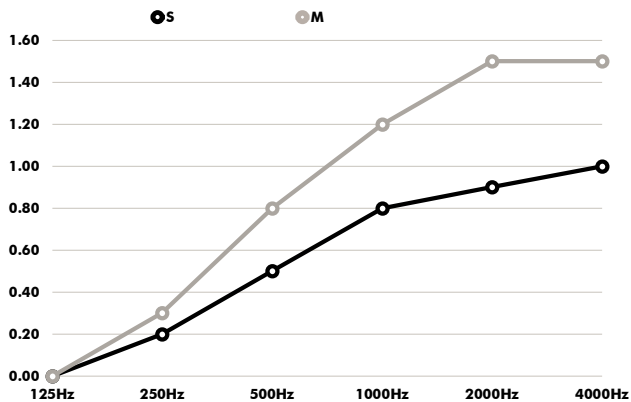

Hz	S Aeq/m ²	M Aeq/m ²
125	0.0	0.0
250	0.2	0.3
500	0.5	0.8
1000	0.8	1.2
2000	0.9	1.5
4000	1	1.5

Dimensions

Acoustic Panel Round

L

M

S

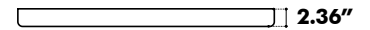
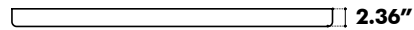
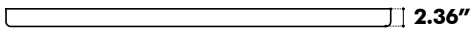
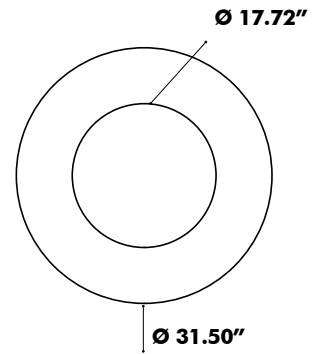
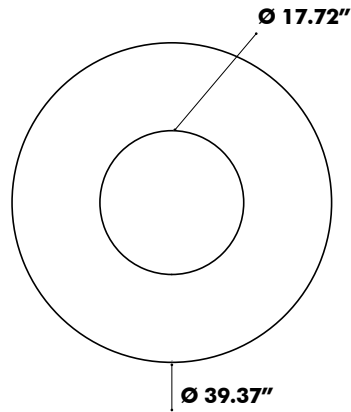
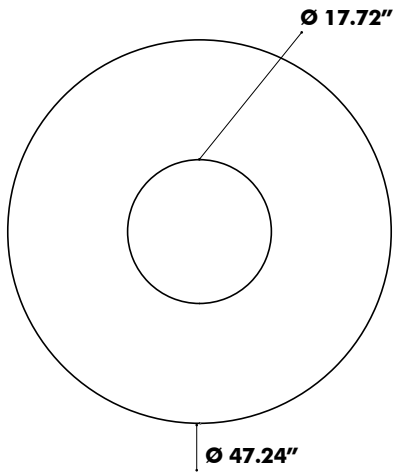

Ceiling Mounted Round

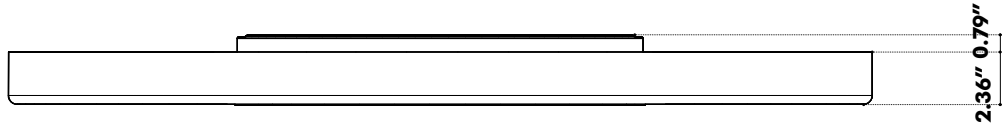

Ceiling Suspended Round

Split

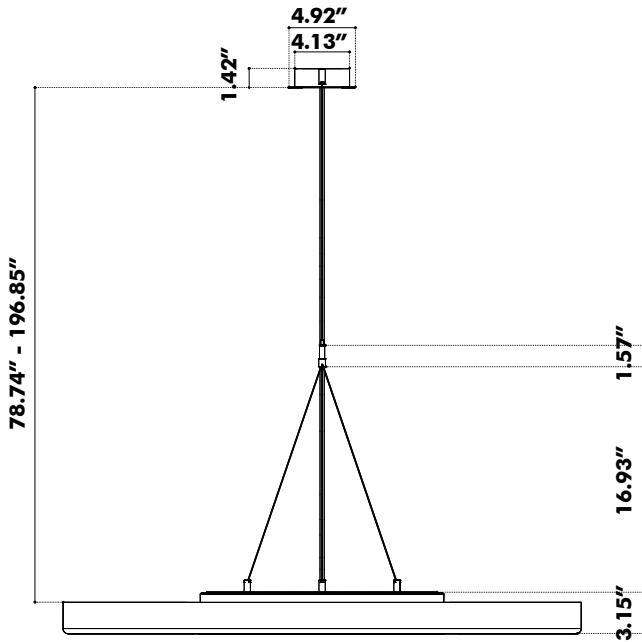

Ceiling Suspended Round

Straight

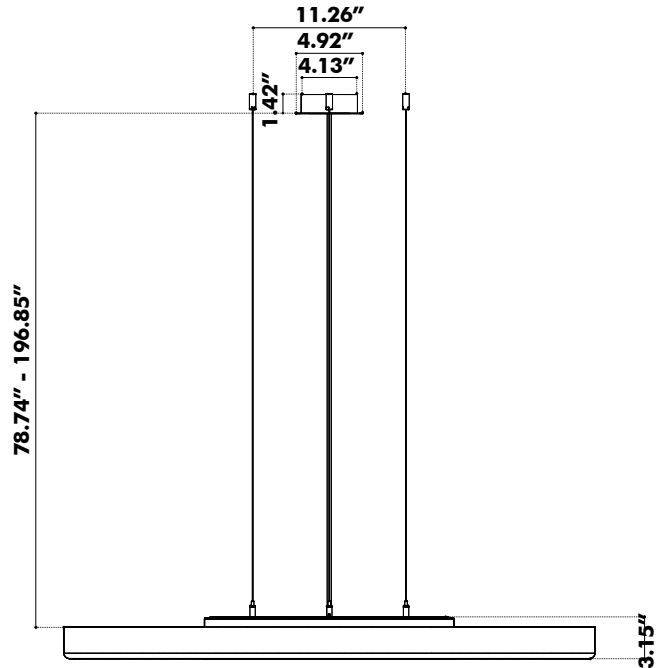

Acoustic Panel Oval

M

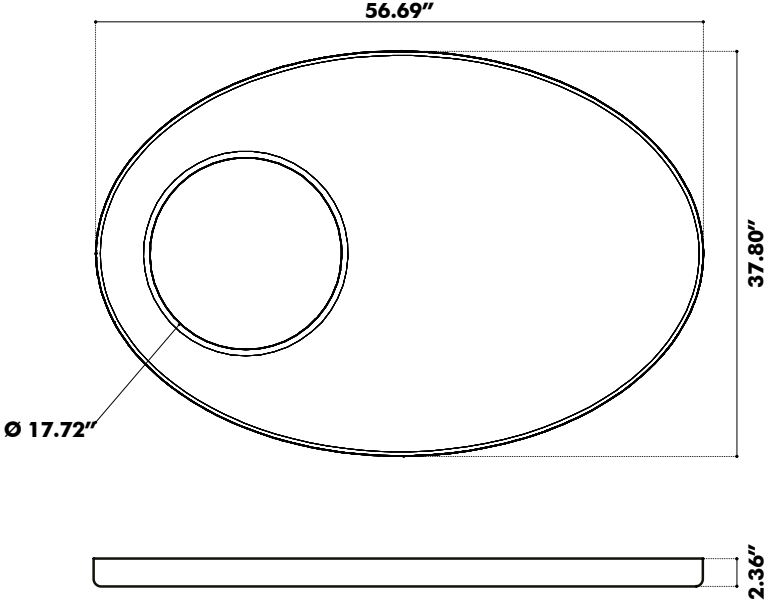

S

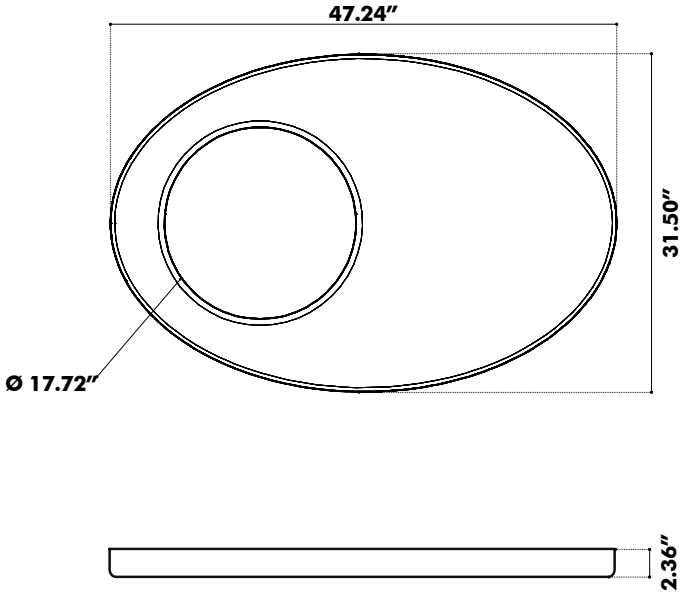

Ceiling Suspended Split Oval

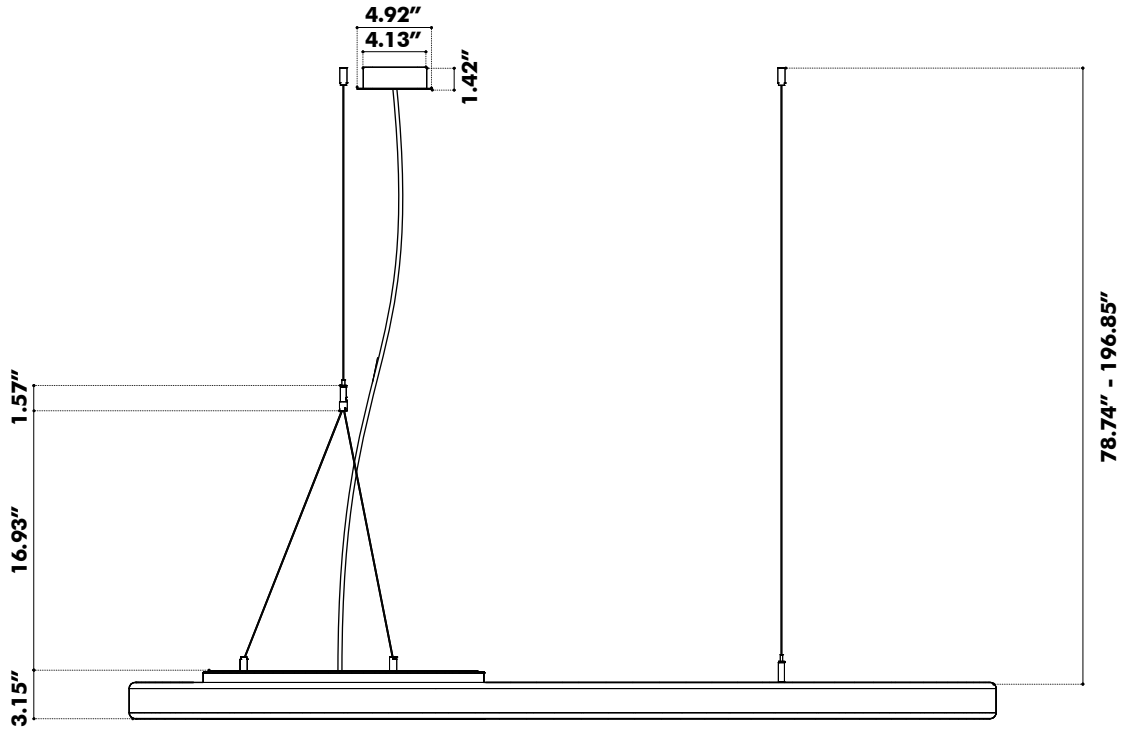

Ceiling Suspended Straight Oval

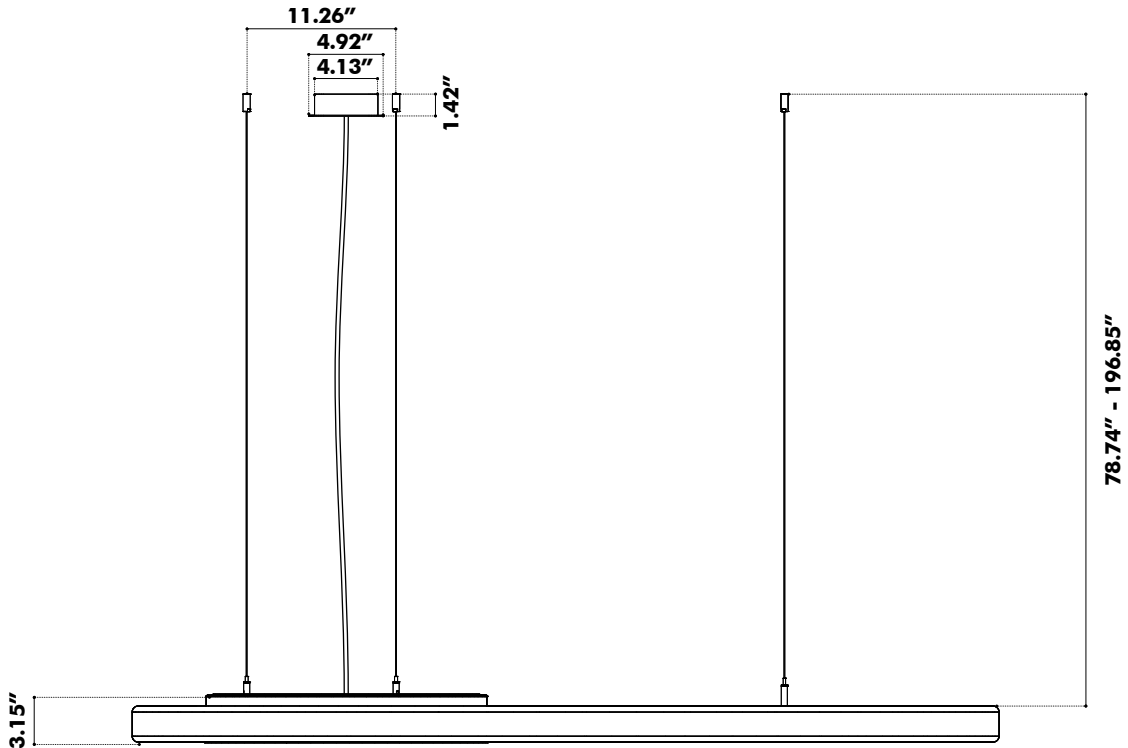

Weights

BuzziMoon Small Ceiling Mounted Round

 18.74 lbs

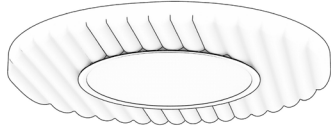

BuzziMoon Medium Ceiling Mounted Round

 23.15 lbs

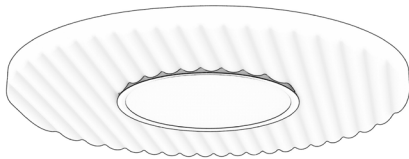

BuzziMoon Large Ceiling Mounted Round

 27.56 lbs

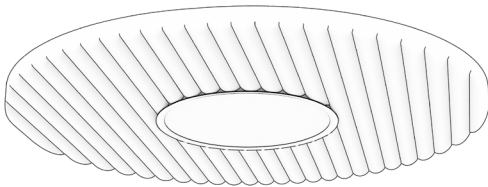

BuzziMoon Small Ceiling Suspended Round

 20.94 lbs

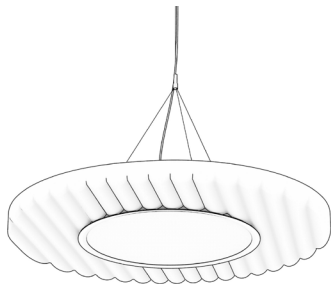

BuzziMoon Medium Ceiling Suspended Round

25.35 lbs

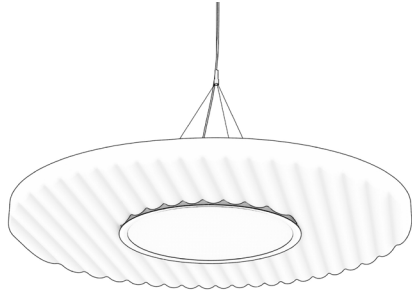

BuzziMoon Large Ceiling Suspended Round

29.76 lbs

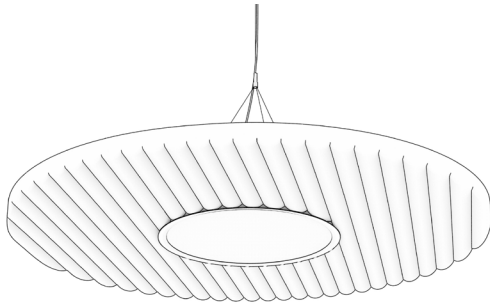

BuzziMoon Small Ceiling Suspended Oval

22.05 lbs

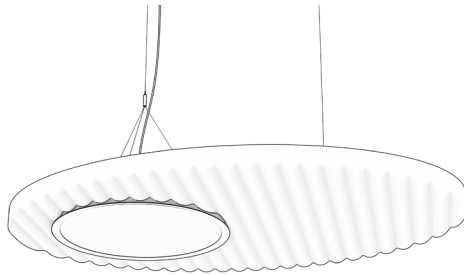

BuzziMoon Medium Ceiling Suspended Oval

26.46 lbs

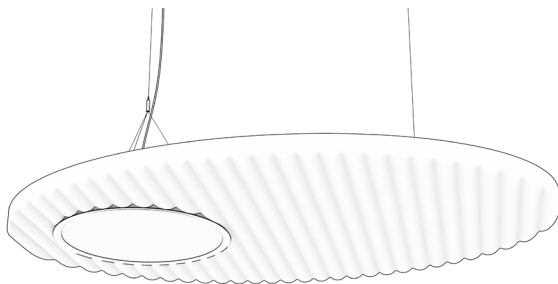

Fabrics

Fabric (45 colors)

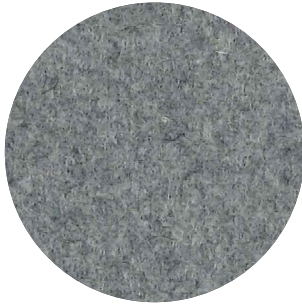

Category A

Composition 70% Recycled Wool, 25% Recycled Polyacryl,
5% Recycled Other Fabrics

Weight 405 g/m² | 11.94 oz/yd²

Abrasion resistance 40.000 Martindale, 50,000 Wyzenbeek

Flammability EU: EN 1021.1/2006 | BS EN 1021.1/2006 (cigarette).
EN 1021.2/2006 | BS EN 1021.2/2006 (match)
USA: CAL TB 117 | ASTM E84 CLASS A

Fastness to light EU: 4 | USA 4

Fastness to rubbing EU: Wet 3-4 | Dry 4-5

Fastness to crocking USA: Wet 5 | Dry 5



Trevira CS (47 colors)

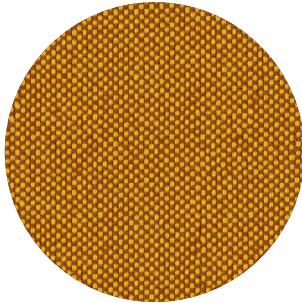

Category A

Weight 420 g/m² | 12.39 oz/yd²

Composition 100% Polyester, Trevira CS

Abrasion resistance 100.000 Martindale, 90,000 Wyzenbeek

Flammability BS 5852 part II: CRIB 5 | BS 7176 Medium Hazard
USA: CAL TB 117 | M1 | B1 | EN 1021/1-2 | C1 |
IMO Res. A652 (16)

Fastness to light EU: 6 | USA 5

Fastness to rubbing EU: Wet 4-5 | Dry 4-5

Fastness to crocking USA: Wet 5 | Dry 5



Reflect (34 colors)

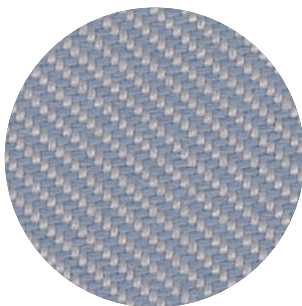

Category A

Weight 430 g/m² | 13.78 oz/yd²

Composition 100% Post-consumer recycled polyester

Abrasion resistance 100.000 Martindale

Flammability AS/NZS 3837 class 1 | ASTM E84 Class A Unadhered

ASTM E84 Class B Adhered | BS 5852 crib 5 with treatment

BS 5852 part 1 with treatment | EN 1021-1/2 | US Cal. Bull. 117-2013

Fastness to light Note 5-7, ISO 105-B02

Fastness to rubbing EU: Wet 5-5 | Dry 5-5

Pilling Note 4, EN ISO 12945



kvadrat

Revive 1 (25 colors)

kvadrat

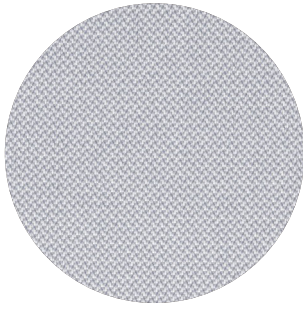

Category A

Composition 100% recycled polyester FR

Weight 430 g/lin.m

Abrasion resistance 60.000 Martindale rubs, EN ISO 12947

Flammability EN 1021-1/2 | DIN 4102 B1 | Önorm B1/Q1

UNI 9175 11M | US Cal. Tech. Bull. 117

IMO A.652 (16)

Fastness to light Note 5-7, ISO 105-B02

Fastness to rubbing (ISO) dry 5, wet 4-5

Pilling Note 4-5, EN ISO 12945



Clara 2 (24 colors)

kvadrat

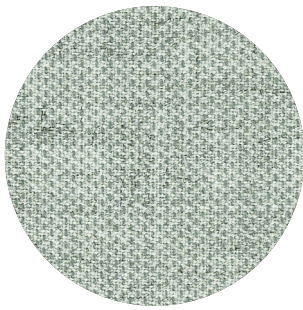

Category B

Composition 92% new wool, 8% nylon

Weight 400 g/lin.m

Abrasion resistance 80.000 Martindale rubs, EN ISO 12947

Flammability EN 1021-1/2 | BS 5852, ignition source 2-3 | DIN 4102 B2

NF D 60 013 | UNI 9175 11M | US Cal. Tech. Bull. 117, Sec. E

NFPA 260 | IMO A.652(16)

Fastness to light Note 5-7, ISO 105-B02

Fastness to rubbing (ISO) dry 4-5, wet 4

Pilling Note 4, EN ISO 12945



Remix 3 (73 colors)

kvadrat



Category B

Composition 90% new wool, 10% nylon

Weight 415 g/lin.m

Abrasion resistance 100.000 Martindale rubs, EN ISO 12947

Flammability EN 1021-1/2 | BS 5852 part 1

Önorm B1/Q1 | NF D 60 013 | UNI 9175, 11M

AS/NZS 1530.3 | Cal. Tech. Bull. 117-2013

NFPA 260 | IMO FTP Code 2010:Part 8

Fastness to light Note 5-7, ISO 105-B02

Fastness to rubbing (ISO) dry 4-5, wet 4

Pilling Note 4, EN ISO 12945



Hero 2 (33 colors)

kvadrat

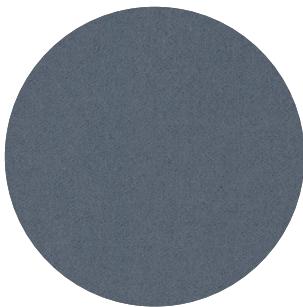

Category C

Composition 97% new wool, 3% nylon

Weight 580 g/lin.m

Abrasion resistance 45.000 Martindale rubs, EN ISO 12947

Flammability EN 1021-1/2 | DIN 4102 B2 | NF D 60 013

UNI 9175 11M | US Cal. Bull. 117-2013 | NFPA 260

IMO A.652 (16)

Fastness to light Note 5-6, ISO 105-B02

Fastness to rubbing (ISO) dry 4-5, wet 4-5

Pilling Note 3-4, EN ISO 12945



Hero 2 (33 colors)

kvadrat

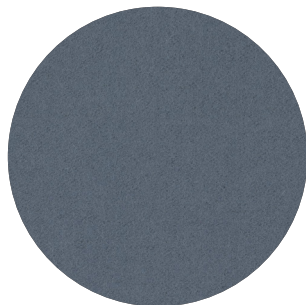

Category C

Composition 97% new wool, 3% nylon

Weight 580 g/lin.m

Abrasion resistance 45.000 Martindale rubs, EN ISO 12947

Flammability EN 1021-1/2 | DIN 4102 B2 | NF D 60 013
UNI 9175 11M | US Cal. Bull. 117-2013 | NFPA 260
IMO A.652 (16)

Fastness to light Note 5-6, ISO 105-B02

Fastness to rubbing (ISO) dry 4-5, wet 4-5

Pilling Note 3-4, EN ISO 12945



Tonus 4 (47 colors)

kvadrat

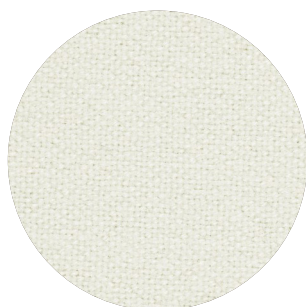

Category D

Composition 90% new wool, 10% Helanca

Weight 665 g/lin.m

Abrasion resistance 100.000 Martindale rubs, EN ISO 12947

Flammability EN 1021-1/2 | BS 5852 part 1 | DIN 4102 B2
Önorm B1/Q1 | NF D 60 013 | UNI 9175 11M
US Cal. Bull. 117-2013 | NFPA 260 | IMO A.652 (16)

Fastness to light Note 5-7, ISO 105-B02

Fastness to rubbing (ISO) dry 3-5, wet 3-5

Pilling Note 3, EN ISO 12945



Arda (12 colors)

kvadrat

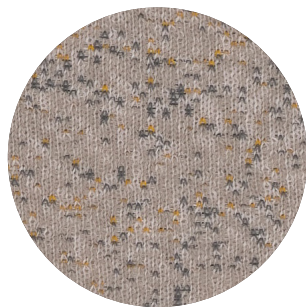

Category E

Composition 70% new wool 21% polyester 9% nylon

Weight 800 g/lin. m | 25.8 oz/ly

Abrasion resistance

Approx. 50.000 Martindale rubs, EN ISO 12947

Flammability ASTM E84 Class A Unadhered | AS/NZS 3837 class 2 | BS 5852 part 1
BS 5852 crib 5 | DIN 4102 B2 | EN 1021-1/2 | IMO FTP Code 2010 Part 8
UNI 9175 11M | US Cal. Bull. 117-2013

Fastness to light Note 5-8, ISO 105-B02

Fastness to rubbing Dry note 3-5 ISO 105-X12
Wet note 3-5 ISO 105-X12

Pilling Note 4, EN ISO 12945



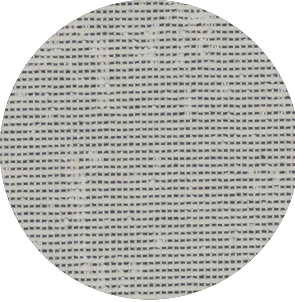

Category E

Composition 100% Trevira CS

Weight 700 g/lin.m

Abrasion resistance

35.000 rubs acc. to the Martindale method, EN ISO 12947

Flammability EN 1021-1/2 | DIN 4102 B1 | Önorm B1/Q1
NF D 60 013 | NF P 92 507 M1 | UNI 9175 1IM
UNI 9177 classe 1 | US Cal. Tech. Bull. 117
IMO A.652 (16)

Fastness to light Note 5-8, ISO 105-B02

Fastness to rubbing (ISO) dry 4-5, wet 4-5

Pilling Note 4, EN ISO 12945

